

FLOOR & WALL DESIGN

**MARVEL**  
PRO



atlas concorde





MARVEL  
PRO  
**WALL  
DESIGN**  
WHITE-BODY  
WALL TILES

WHITE-BODY WALL TILES | RIVESTIMENTI IN PASTA BIANCA  
Revêtements en pâte blanche | Weißscherbige Wandfliesen  
Revestimientos en pasta blanca | Настенная плитка из белой глины

MARVEL  
PRO  
**FLOOR  
DESIGN**  
PORCELAIN  
TILES

COLOURED BODY PORCELAIN TILES | GRES PORCELLANATO COLORATO IN MASSA  
Grès cérame coloré dans la masse | Durchgefärbtes Feinsteinzeug  
Grès porcelánico coloreado en masa | керамический гранит окрашенный в массу

  
**atlas concorde**

MADE IN ITALY

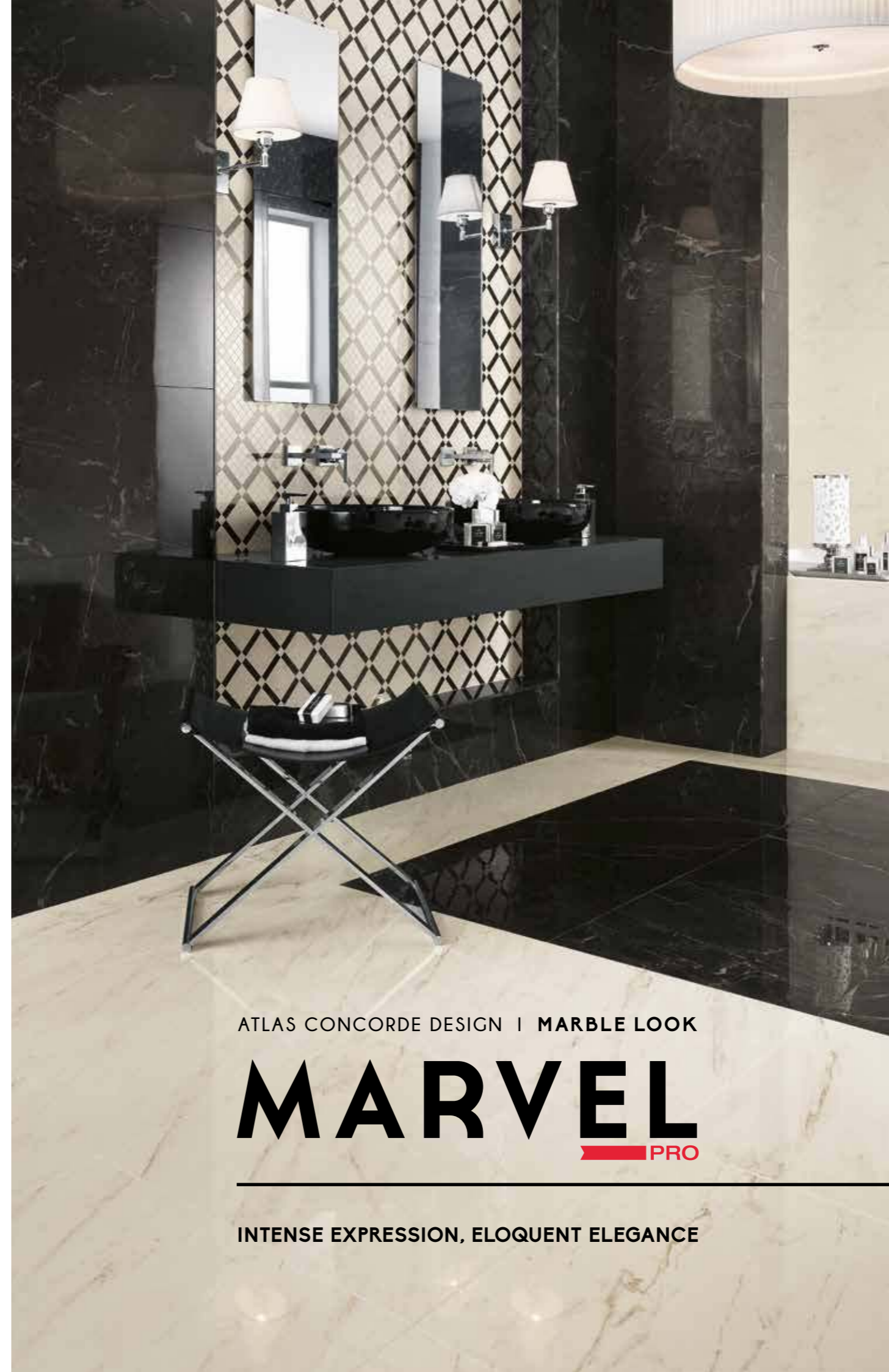

ATLAS CONCORDE DESIGN | MARBLE LOOK

**MARVEL**  
PRO

INTENSE EXPRESSION, ELOQUENT ELEGANCE

**A complete project of porcelain floor tiles and coordinated wall tiles interprets, with extraordinary realism and sought-after details, a selection of precious and cutting-edge marble to meet the aesthetic and functional needs of contemporary architecture for interiors and exteriors.**

Un progetto completo di pavimenti in gres porcellanato e di rivestimenti coordinati interpreta con straordinario realismo e cura del dettaglio una selezione di marmi pregiati e di tendenza, per rispondere con efficacia alle esigenze estetiche e funzionali della progettazione architettonica contemporanea di interni ed esterni.

Un projet complet de sols en grès cérame et de revêtements coordonnés interprète à travers un extraordinaire réalisme et soin du détail une sélection de marbres précieux et de tendance, pour offrir une réponse efficace aux exigences esthétiques et fonctionnelles de la conception architecturale contemporaine d'intérieur et d'extérieur.

*Eine vollständige Lösung für Fußböden in Feinsteinzeug und darauf abgestimmte Wandbeläge interpretiert mit außergewöhnlichem Realismus und viel Liebe zum Detail, eine Auswahl von hochwertigen und aktuellen Marmorarten, um wirksam die ästhetischen und funktionalen Bedürfnisse der modernen architektonischen Gestaltung von Innen- und Außenbereichen zu erfüllen.*

Un proyecto integral de pavimentos en gres porcelánico y de revestimientos coordinados interpreta con extraordinario realismo y atención por los detalles una selección de mármoles valiosos y de tendencia, para responder con eficacia a las exigencias estéticas y funcionales de la proyectación arquitectónica contemporánea de interiores y exteriores.

*Превосходный керамический проект, состоящий из напольного керамогранита и настенных плиток, с изумительным реализмом воспроизводит фактуру ценнейших пород мрамора, предлагая исчерпывающий ответ на любые функциональные и эстетические требования современного проектирования внутренних и наружных пространств.*



# INTENSE EXPRESSION, EXTRAORDINARY REALISM

## INTENSA ESPRESSIVITÀ, STRAORDINARIO REALISMO

Inspired by a sought-after selection of precious marble slabs of European origin, Marvel PRO integrates and broadens the potential of the Marvel collection, creating a complete project of porcelain floors and coordinated wall tiles that faithfully reproduce natural marble and offer a broad range of graphics, sizes and surface finishes. Marvel PRO combines the excellent interpretation of natural marble and the technical features and functional advantages of the best porcelain floors and white-body wall tiles by Atlas Concorde.



### UNE INTENSE EXPRESSIVITÉ, UN RÉALISME EXTRAORDINAIRE

Inspiré par une sélection de précieuses dalles en marbre européen, Marvel PRO intègre et multiplie les capacités de la collection Marvel, en donnant vie à un projet complet de sols en grès cérame et revêtements coordonnés, qui reproduisent dans les moindres détails les marbres naturels de référence en proposant une surprenante extension de gamme en termes de graphiques, formats et finitions de surface. Marvel PRO associe la parfaite interprétation de l'imitation marbre aux caractéristiques techniques et aux avantages fonctionnels des meilleurs sols en grès cérame et revêtements en pâte blanche d'Atlas Concorde.

### INTENSIVE AUSDRUCKSKRAFT, AUßERGEWÖHNLICHER REALISMUS

Inspiziert durch eine sorgsame Auswahl von hochwertigen Marmorplatten aus Europa integriert und verstärkt Marvel PRO das Potential der Kollektion Marvel und schafft eine vollständige Lösung für Fußböden in Feinsteinzeug und darauf abgestimmte Wandbeläge, die absolut originalgetreu den als Vorlage dienenden natürlichen Marmor nachbilden, um eine überraschende Erweiterung des Sortiments in Sachen Grafik, Formate und Oberflächen anzubieten. Marvel PRO verbindet eine hervorragende Interpretation von Marmor mit den technischen Eigenschaften und den funktionalen Vorteilen der besten Fußböden in Feinsteinzeug und Wandbeläge in weißer Tonmasse von Atlas Concorde.



### INTENSA EXPRESIVIDAD, REALISMO EXTRAORDINARIO

Inspirado en una cuidada selección de valiosas losas de mármol de procedencia europea, Marvel PRO integra y amplifica el potencial de la colección Marvel, dando vida a un proyecto integral de pavimentos de gres porcelánico y revestimientos coordinados, que reproducen con absoluta fidelidad los mármoles naturales de referencia, proponiendo una sorprendente extensión de gama en términos de elementos gráficos, formatos y acabados de superficie. Marvel PRO conjuga una excelente interpretación del efecto mármol con las características técnicas y los beneficios funcionales de los mejores pavimentos de gres porcelánico y revestimientos de pasta blanca de Atlas Concorde.

### ЯРКАЯ ВЫРАЗИТЕЛЬНОСТЬ, ИЗУМИТЕЛЬНЫЙ РЕАЛИЗМ

Коллекция Marvel PRO навеяна благородным видом ценных пород европейского мрамора и появилась как естественное дополнение линейки Marvel. Это комплексный керамический проект, включающий напольный керамогранит и настенную плитку, чья фактура с максимальной точностью передает богатый рисунок исходных природных образцов. Кроме того, коллекция заметно расширяет гамму рисунков, форматов и видов поверхностей, усиливая и без того огромный оформительский потенциал линейки в целом. В Marvel PRO соединены восхитительная интерпретация мраморных фактур, функциональность и отличные технические качества лучших керамогранитных плиток для полов и лучших настенных плиток из белой глины Atlas Concorde.



MARVEL  
PRO  
FLOOR  
& WALL  
MARBLE  
LOOK



MARVEL  
PRO  
**FLOOR  
DESIGN**  
PORCELAIN  
TILES



# ELOQUENT ELEGANCE

## ELOQUENTE ELEGANZA

**Intense veining, natural shades and refined appeal characterize the marble inspired floor tiles of Marvel PRO, solutions featuring tremendous graphic versatility and faithfully reproducing the details of the natural material. Marvel PRO combines the personality and expression of natural marble with the advantages of porcelain tiles, guaranteeing the perfect reproducibility of the surface over time and top-quality technical properties in terms of resistance to wear, staining and detergents.**

Venature intense, gradazioni naturali ed estetica raffinata caratterizzano i pavimenti in gres porcellanato effetto marmo di Marvel PRO, soluzioni dalla elevata variabilità grafica che riproducono con precisione i particolari della materia originaria. Marvel PRO unisce la personalità e la forza espressiva dell'effetto marmo ai vantaggi del gres, garantendo una perfetta riproducibilità nel tempo della stessa superficie e ottime caratteristiche tecniche in termini di resistenza all'usura, alle macchie e al contatto con i detersivi.



Travertino Alabastrino  
HONED Lappato



Travertino Silver  
HONED Lappato

### UNE ÉLÉGANCE ÉLOQUENTE

Des veines intenses, des nuances naturelles et une esthétique raffinée caractérisent les sols en grès cérame imitation marbre de Marvel PRO, des solutions aux graphismes très variés qui reproduisent avec précision les détails de la matière d'origine. Marvel PRO associe la personnalité et la force expressive de l'imitation marbre aux avantages du grès, garantissant une parfaite reproductibilité de la surface dans le temps et d'excellentes caractéristiques techniques en termes de résistance à l'usure, aux tâches et au contact avec les détergents.

### VIELSAGENDE ELEGANZ

Intensive Äderungen, natürliche Schattierungen und raffinierte Ästhetik kennzeichnen die Fußböden aus Feinsteinzeug mit Marmor-Optik von Marvel PRO, Lösungen von hoher graphischer Variabilität, die exakt die Details der ursprünglichen Materie imitieren. Marvel PRO kombiniert die Persönlichkeit und die Ausdruckskraft des Marmors mit den Vorteilen des Feinsteinzeugs und garantiert auch im Laufe der Zeit eine perfekte Imitation der Oberfläche sowie hervorragende technische Eigenschaften wie Abriebfestigkeit, Fleckenbeständigkeit und Beständigkeit im Kontakt mit Reinigungsmitteln.

### ELOCUENTE ELEGANCIA

Vetas intensas, gradaciones naturales y estética refinada caracterizan los pavimentos en gres porcelánico efecto mármol de Marvel PRO, soluciones de gran variabilidad gráfica que reproducen con precisión los detalles del material original. Marvel PRO une la personalidad y la fuerza expresiva del efecto mármol con las ventajas del gres, garantizando una perfecta reproductibilidad de la superficie a lo largo del tiempo y óptimas características técnicas en términos de resistencia al desgaste, a las manchas y al contacto con los detergentes.

### ВОСХИТИТЕЛЬНАЯ ЭЛЕГАНТНОСТЬ

Ярко выраженные прожилки, натуральные оттенки и изысканная эстетика характеризуют керамогранитные полы под мрамор Marvel PRO. Это поверхности с неповторяющимся рисунком, преданно воспроизводящие каждую деталь природного материала. Marvel PRO сочетает в себе красоту мрамора с лучшими техническими качествами керамогранита. Плитки сохраняют свой первоначальный вид даже после долгих лет эксплуатации, стойки к износу, образованию пятен, воздействию моющих средств.

Crema Delicato  
HONED Lappato





## PRECIOUS SELECTION SELEZIONE PREGIATA

Inspired by natural marble, Marvel PRO porcelain tiles offer a selection of six natural marbles with a marked and refined character, in line with a contemporary interpretation of natural materials in-keeping with the latest interior and exterior design trends.

### UNE SÉLECTION PRÉCIEUSE

Le grès cérame imitation marbre de Marvel PRO propose une minutieuse sélection de six références naturelles au caractère fort et raffiné, en accord avec une interprétation contemporaine de la matière d'inspiration selon les dernières tendances du design pour intérieurs et extérieurs.

### ERLESENE AUSWAHL

Das Feinsteinzeug mit Marmor-Optik von Marvel PRO bietet eine sorgfältige Auswahl von sechs natürlichen Marmorarten von starkem und anspruchsvollem Charakter, im Einklang mit einer modernen Interpretation der Marmorvorlagen nach den neuesten Designtrends für Innen- und Außenbereiche.

### SELECCIÓN VALIOSA

El grés porcelánico efecto mármol de Marvel PRO propone una cuidadosa selección de seis referencias naturales de carácter decidido y refinado, en sintonía con una interpretación contemporánea del material de inspiración según las últimas tendencias del diseño para interiores y exteriores.

### ДРАГОЦЕННАЯ КОЛЛЕКЦИЯ

Кермогранит под мрамор Marvel PRO предлагает шесть ярких и изысканных фактур, интерпретирующих природный материал в современном ключе, согласно последним тенденциям интерьерного и экстерьерного дизайна.

Il grés porcellanato effetto marmo di Marvel PRO propone un'accurata selezione di sei riferimenti naturali dal carattere forte e raffinato, in linea con una interpretazione contemporanea della materia di ispirazione secondo le ultime tendenze del design per interni ed esterni.



STATUARIOSELECT  
Authentic splendour



CREMODELICATO  
Delicate character



TRAVERTINOSILVER  
Timeless charm



TRAVERTINOALABASTRINO  
Contemporary elegance



GREYFLEURY  
Actual refinement



NOIRSAINTLAURENT  
Deep soul





75x150 cm

75x75 cm

45x90 cm

60x60 cm

30x60 cm

↑  
Noir Saint Laurent  
HONED Lappato



MARVEL  
PRO  
**HONED**  
LAPPATO  
PORCELAIN  
TILES

↑  
Travertino Silver  
HONED Lappato



### BRILLIANT SEDUCTION

Marvel PRO includes a shiny honed finish, characterised by an extraordinarily brilliant surface that faithfully reproduces the glitter of aged polished marble and the slight irregularities of the natural material, at the same time guaranteeing excellent technical properties in terms of wear resistance and easy maintenance. The broad range of sizes up to the large 75x150 allows for the utmost planning freedom for the application in exclusive residential spaces and prestigious medium-traffic commercial venues.

#### UNE SÉDUCTION BRILLANTE

Marvel PRO inclut une finition adoucie très polie, caractérisée par une surface merveilleusement brillante et réfléchissante, qui reproduit fidèlement l'éclat des marbres antiques polis et les légères irrégularités de la matière d'inspiration, tout en garantissant d'exceptionnelles propriétés techniques de résistance à l'usure et de facilité d'entretien. La vaste gamme de formats s'étend jusqu'à 75x150 et offre une grande liberté de conception pour des applications dans des milieux résidentiels de haute qualité et des contextes commerciaux de prestige moyennement fréquentés.

#### GLÄNZENDE VERFÜHRUNG

Marvel PRO beinhaltet ein super glänzendes, geläpptes Finish, gekennzeichnet durch eine außergewöhnlich helle und reflektierende Oberfläche, die mit großer Treue die Leuchtkraft von poliertem, leicht antikisiertem Marmor und die leichten Unregelmäßigkeiten der Vorlage nachbildet und dabei ausgezeichnete technische Eigenschaften der Verschleißfestigkeit und Wartungsfreundlichkeit garantiert. Die breite Palette von Formaten, die bis zum 75x150 reichen, sorgt für große Gestaltungsfreiheit beim Einsatz in hochwertigen Wohn- und Gewerbebereichen mit leichtem bis mittlerem Durchgangsverkehr.

#### SEDUCCIÓN BRILLANTE

Marvel PRO incluye un lucidísimo acabado pulido, caracterizado por una superficie extraordinariamente brillante y reflectante, que reproduce con fidelidad la luminosidad de los mármoles bruñidos levemente envejecidos y las ligeras irregularidades del material de inspiración, garantizando excepcionales propiedades técnicas de resistencia al desgaste y de facilidad de manutención. La vasta gama de formatos se extiende hasta el 75x150 y permite una gran libertad de diseño para aplicaciones en ambientes residenciales de alto nivel y comerciales de prestigio de tránsito medio-ligero.

#### СОБЛАЗНИТЕЛЬНЫЙ БЛЕСК

Лаппатированная поверхность керамогранита Marvel PRO имеет почти зеркальный вид с легкими, типичными для природного мрамора неровностями и таким же блеском, как у полированного и слегка состаренного мрамора. В то же время она исключительно стойка к износу и удивительно проста в уходе. Обширная гамма форматов, вплоть до 75x150, открывает большие композиционные возможности при оформлении элитных жилых пространств и престижных коммерческих интерьеров с небольшой и средней интенсивностью эксплуатации.

### SEDUZIONE BRILLANTE

Marvel PRO include una lucidissima finitura lappata, caratterizzata da una superficie straordinariamente brillante e specchiante, che riproduce con fedeltà la luminosità dei marmi levigati lievemente anticati e le leggere irregolarità della materia di ispirazione, garantendo eccezionali proprietà tecniche di resistenza all'usura e di facilità di manutenzione. La vasta gamma di formati si estende fino al 75x150 e consente una grande libertà progettuale per applicazioni in ambienti residenziali di alto livello e commerciali di prestigio a traffico medio-leggero.



## BRILLIANT SOFTNESS

The satin finish is characterised by a refined honed gres surface, with satin effect and velvety to the touch; thanks to the spreading of a soft and alluring light, it creates a sense of naturalness in contemporary spaces.

### UNE DOUCEUR LUMINEUSE

La finition satin est une surface adoucie en grès cérame, avec un effet satin et veloutée au toucher ; grâce à la diffusion de la lumière douce et enveloppante suscite dans les espaces contemporains une profonde sensation de naturel.

### HELLE WEICHHEIT

Die Oberfläche Satin ist eine raffinierte, geläppte Oberfläche aus Feinsteinzeug, matt und samtig beim Anfassen, die dank einer weichen und behaglichen Lichtverteilung zeitgenössische Ambiente mit einem tiefen Gefühl von Natürlichkeit schafft.

## LUMINOSA MORBIDEZZA

La finitura satin è caratterizzata da una raffinata superficie lappata in gres porcellanato a effetto satinato e vellutata al tatto; grazie a una diffusione della luce morbida e avvolgente crea negli ambienti contemporanei un profondo senso di naturalezza.

### LUMINOSA SUAVIDAD

El acabado satin es una refinada superficie pulida en gres porcelánico de efecto satinado y aterciopelada al tacto; gracias a una difusión de una luz suave y envolvente crea en los ambientes contemporáneos una profunda sensación de naturalidad.

### ЯРКАЯ МЯГКОСТЬ

Керамогранитная поверхность предложена в лаппатированном варианте с мягким на ощупь сатинованным эффектом, чей мягкий блеск приносит в современные пространства глубокую натуральность.



**MARVEL  
PRO  
SATIN  
SATINATO  
PORCELAIN  
TILES**

60x60 cm



**MARVEL  
PRO  
MATT  
MATT  
PORCELAIN  
TILES**

45x90 cm

60x60 cm

30x60 cm

Grey Fleury  
MATT Matt

## CONTEMPORARY FASCINATION

The matt finish is the perfect solution in elegant spaces of contemporary and minimal design, in particular for medium-traffic commercial venues. Available in three sizes, the matt surface evokes the appeal of stone especially in colours Grey Fleury and Crema Delicato.

### UN CHARME CONTEMPORAIN

La finition matt est la solution idéale dans des espaces élégants au design contemporain et essentiel, particulièrement adaptée pour des applications dans des contextes commerciaux moyennement fréquentés. Disponible dans trois formats, la surface matt évoque l'esthétique de la pierre, particulièrement dans les teintes Grey Fleury et Crema Delicato.

### MODERNER CHARME

Die matte Oberfläche ist die ideale Lösung in eleganten modernen Designräumen, besonders geeignet für Anwendungen in kommerziellen Ambienten mit mittlerer Beanspruchung. Erhältlich in drei Formaten erinnert die matte Oberfläche an die Schönheit des Steins, vor allem in den Farben Grey Fleury und Crema Delicato.

## FASCINO CONTEMPORANEO

La finitura matt è la soluzione ideale in spazi eleganti dal design contemporaneo ed essenziale, particolarmente adatta per applicazioni in ambienti commerciali a medio traffico. Disponibile in tre formati, la superficie matt evoca l'estetica della pietra, specialmente nelle tonalità Grey Fleury e Crema Delicato.

### ENCANTO CONTEMPORÁNEO

El acabado matt es la solución ideal para espacios elegantes de diseño contemporáneo y esencial, particularmente apropiado para aplicaciones en ambientes comerciales de tránsito medio. Disponible en tres formatos, la superficie matt evoca la estética de la piedra, especialmente en las tonalidades Grey Fleury y Crema Delicato.

### СОВРЕМЕННОЕ ОЧАРОВАНИЕ

Матовая поверхность – идеальное решение для элегантных, современных, лаконичных по дизайну коммерческих пространств со средней интенсивностью эксплуатации. Доступна в трех форматах и особенно эффектно воспроизводит фактуру камня в цветах Grey Fleury и Crema Delicato.



Grey Fleury  
TEXTURED Strutturato



MARVEL  
PRO  
TEXTURED  
STRUTTURATO  
PORCELAIN  
TILES

30x60 cm



COLOURS  
Statuario Select, Grey Fleury, Crema Delicata

FLOOR  
DESIGN  
PORCELAIN  
TILES

## SEDUCING EXTERIORS

The textured finish reproduces the traditional three-dimensional milling, bringing the fascination of the natural material to the outdoors and to indoor spaces that require anti-slip features, such as spas and areas subject to humidity. The textured finish contributes to the planning of continuous indoor and outdoor spaces and can also be used on walls with a decorative potential.

### DES EXTÉRIEURS SÉDUISANTS

La finition structurée reproduit l'usinage typique du fraisage tridimensionnel du marbre, en proposant le charme de la matière de référence jusque dans les extérieurs et les espaces intérieurs qui exigent des caractéristiques antidérapantes, comme les spa et les zones humides. La surface structurée contribue à la conception d'espaces où l'intérieur et l'extérieur s'intègrent dans une parfaite continuité visuelle et matérielle, et peut être également utilisée comme revêtement de décoration.

### VERFÜHRERISCHE AUßENBEREICHE

Die strukturierte Oberfläche ahmt die typische dreidimensionale Fräsbearbeitung des Marmors nach und trägt die Faszination des Vorlagematerials auch in Innen- und Außenbereiche, die rutschfeste Eigenschaften erfordern, wie Spa-Ambiente und Feuchtzonen. Die strukturierte Oberfläche trägt zur Gestaltung von Räumen bei, in denen Innen- und Außenbereiche eine totale optische und stoffliche Kontinuität bilden, zudem kann sie auch als dekorativer Wandbelag verwendet werden.

### SEDUCTORES EXTERIORES

El acabado estructurado reproduce la típica elaboración del fresado tridimensional del mármol, transportando el encanto del material de referencia incluso a los exteriores y a los ambientes interiores que requieren características antideslizamiento, como los spa y las zonas sometidas a humedad. La superficie estructurada contribuye a la proyectación de espacios en los que indoor y outdoor se integran en total armonía visual y material y puede ser empleada también como revestimiento con valencia decorativa.

### ОБАЯТЕЛЬНЫЕ НАРУЖНЫЕ ПРОСТРАНСТВА

Структурная поверхность воспроизводит характерную рельефную фактуру подвергнутого фрезеровке мрамора и позволяет перенести очарование этого природного материала даже на улицу или в интерьеры, где от покрытий требуется повышенное сопротивление скольжению, такие как СПА-залы или любые другие влажные помещения. Такая поверхность дает также возможность создать цельные дизайнерские проекты, в которых наружные пространства являются естественным продолжением внутренних. Кроме того, структурные плитки можно укладывать на стены для создания стильного декоративного эффекта.

## SEDUCENTI ESTERNI

La finitura strutturata riproduce una tipica lavorazione di fresatura tridimensionale del marmo, portando il fascino della materia di riferimento anche negli esterni e negli ambienti interni che richiedono caratteristiche antiscivolo, come nelle spa e nelle zone soggette a umidità. La superficie strutturata contribuisce alla progettazione di spazi in cui interno ed esterno si integrano in totale continuità visiva e materica e può essere utilizzata anche a rivestimento con valenza decorativa.

FLOOR  
DESIGN  
PORCELAIN  
TILES

## EXCELLENT PERFORMANCE

Marvel PRO LASTRA 20mm features the same three-dimensional relief of the textured finish and is perfect for anti-slip safe exteriors requiring excellent technical performance. For installation onto grass, gravel and sand, LASTRA 20mm guarantees easy laying and handling.

### DES PRESTATIONS EXCELLENTE

Marvel PRO LASTRA 20mm présente le même relief tridimensionnel de la finition structurée, idéal pour des extérieurs sécurisés antidérapants qui exigent des prestations techniques élevées. Dans la pose à sec sur gazon, gravier et sable, LASTRA 20mm est une solution qui garantit facilité de pose et simplicité de manipulation.

### AUSGEZEICHNETE LEISTUNGEN

Marvel PRO LASTRA 20mm weist dasselbe dreidimensionale Relief der strukturierten Oberfläche auf und ist ideal für sichere, rutschhemmende Außenbereiche, die hohe technische Leistungen erfordern. Bei der trockenen Verlegung auf Rasen, Kies und Sand ist LASTRA 20mm eine Lösung, die einfaches Verlegen und leichte Handhabung garantiert.

### PRESTACIONES EXCELENTE

Marvel PRO LASTRA 20mm presenta el mismo relieve tridimensional del acabado estructurado y es ideal para exteriores seguros antideslizamiento que requieren elevadas prestaciones técnicas. En la aplicación en seco sobre césped, grava y arena, LASTRA 20mm es una solución que garantiza facilidad de colocación y sencillez de transporte.

### ОТЛИЧНЫЕ ЭКСПЛУАТАЦИОННЫЕ КАЧЕСТВА

Керамогранит Marvel PRO LASTRA 20mm имеет тот же трехмерный рельеф, что и структурные плитки, и идеален для устройства нескользких и безопасных наружных покрытий с повышенными эксплуатационными показателями. Плиты LASTRA 20mm легко укладывать всухую на траву, гравий, песок и так же легко при необходимости убирать.





MARVEL  
PRO  
**WALL  
DESIGN**  
WHITE-BODY  
WALL TILES



^  
Cremo Delicato



# IMPECCABLE APPEAL

## ESTETICA IMPECCABILE

The bright white-body wall tiles of Marvel Pro faithfully reproduce the refinement and chromatic depth of natural marble, sought-after details and rich natural veining emphasise contemporary spaces with style. The tremendous appeal of walls combined with the maximum functionality: the glossy and brilliant surface is easy to clean, the colour does not change and is resistant to staining and chemicals.

I brillanti rivestimenti in pasta bianca Marvel PRO riproducono fedelmente la raffinatezza e la profondità grafica dei marmi d'ispirazione, per soluzioni in cui la cura in ogni dettaglio e la ricchezza di venature naturali enfatizzano con stile ogni ambiente contemporaneo. L'estetica incisiva delle pareti si coniuga con la massima praticità: la superficie lucida e brillante è facilmente pulibile, il colore non si altera, resiste alle macchie e agli agenti chimici.



^  
Noir Saint Laurent

### ESTHÉTIQUE IMPECCABLE

Les revêtements en pâte blanche brillants Marvel PRO reproduisent fidèlement le raffinement et la profondeur graphique des marbres d'inspiration, pour des solutions où le soin du détail et la richesse des veines naturelles subliment avec style tout espace contemporain. L'esthétique incisive des murs s'unit à la praticité absolue : la surface polie et brillante se nettoie facilement, la couleur ne change pas, résiste aux tâches et aux agents chimiques.

### TADELLOSE ÄSTHETIK

Die glänzenden Wandbeläge in weißer Tonmasse Marvel Pro imitieren naturgetreu die Raffinesse und die graphische Tiefe der Marmorvorlagen, für Lösungen bei denen die Liebe zum Detail und der Reichtum der natürlichen Änderungen stilvoll jedes moderne Ambiente gestalten. Die eindrucksvolle Optik der Wände kombiniert sich mit höchster Zweckmäßigkeit: die strahlende und glänzende Oberfläche ist leicht zu reinigen, farbecht, fleckenbeständig und beständig gegen Chemikalien.

### ESTÉTICA IMPECABLE

Los brillantes revestimientos de pasta blanca Marvel Pro reproducen fielmente la elegancia y la profundidad gráfica de los mármoles que los inspiran, para soluciones en las que la atención por los detalles y la riqueza de vetas naturales enfatizan con estilo cualquier ambiente contemporáneo. La estética incisiva de las paredes se conjuga con la máxima practicidad: la superficie reluciente y brillante es limpiable fácilmente, el color no se altera, resiste a las manchas y a los agentes químicos.

### КРАСИВЫЙ ВНЕШНИЙ ВИД

Блестящая настенная плитка из белой глины Marvel Pro искусно воспроизводит изысканную глубину фактуры мрамора. Ухоженность деталей и богатство прожилкового рисунка придают современным интерьерам благородную стильность. В этих настенных плитках слились яркая эстетика и максимальная функциональность: их глянцевая поверхность легко поддается чистке, не выцветает, стойка к образованию пятен и воздействию химикатов.





MARVEL  
PRO  
WALL  
DESIGN  
WHITE-BODY  
WALL TILES

# ELEGANT SHADES

## TONALITÀ ELEGANTI

Statuario Select

Inspired by six precious natural marbles, the walls for interiors of Marvel PRO are the perfect solution to create spectacular spaces of tremendous visual impact, in perfect harmony with the coordinated porcelain floor tiles. The intense and refined colours create elegant compositions in single tint or black and white contrast effect for a timeless contemporary taste.

Inspirati a sei pregiati riferimenti naturali, i rivestimenti per interni di Marvel PRO sono la soluzione ideale per ambienti scenografici e dal grande impatto estetico, in perfetta sintonia con il pavimento in gres porcellanato coordinato. I colori profondi e raffinati danno vita a eleganti composizioni monocromatiche o a giochi in bianco e nero di intramontabile classe e dal gusto contemporaneo.

### DES COULEURS ÉLÉGANTES

Inspirés à six précieuses références naturelles, les revêtements pour intérieurs de Marvel PRO sont la solution idéale pour des espaces scénographiques de grand impact esthétique, en parfait harmonie avec le sol en grès cérame coordonné. Les couleurs profondes et raffinées donnent vie à d'élégantes compositions monochromatiques ou à des jeux de couleurs en noir et blanc d'une classe indémodable dans un style contemporain.

### ELEGANTE FARBEN

Inspiriert durch sechs wertvolle natürliche Referenzen gestalten die Wandbeläge für Innenbereiche von Marvel PRO Wohn- und Gewerbebereiche mit raffinierten Kontrasten oder eleganten einfarbigen Kompositionen, in perfekter Harmonie mit dem Fußboden aus Feinsteinzeug. Die tiefen Farben beleben elegante und raffinierte einfarbige Kompositionen bzw. Schwarz-Weiß-Kombinationen von zeitloser Klasse und zeitgenössischem Geschmack.

### TONALIDADES ELEGANTES

Inspirados en seis valiosos materiales de referencia naturales, los revestimientos para interiores de Marvel PRO son la solución ideal para ambientes escenográficos y de gran impacto estético, en perfecta sintonía con el pavimento de gres porcelánico coordinado. Los colores profundos y refinados dan vida a elegantes composiciones monocromáticas o a juegos en blanco y negro de clase imperecedera y de gusto contemporáneo.

### ЭЛЕГАНТНЫЕ ТОНА

Навеянная шестью ценными породами мрамора, настенная плитка для интерьеров Marvel PRO эффектно декорирует пространства и изысканно гармонирует с напольным керамогранитом той же коллекции. Глубокие и выразительные цвета позволяют создавать монохромные композиции или элегантную игру черно-белых контрастов.

SHINY LUCIDO

40x80 cm

SHINY LUCIDO

30,5x91,5 cm

The two large rectified sizes, 40x80 and 30.5x91.5 enhance the appeal of surfaces in commercial and residential application such as bathroom walls.

I due grandi formati rettificati 40x80 e 30,5x91,5 valorizzano l'estetica di superficie in numerose applicazioni sia commerciali sia residenziali, tra cui i rivestimenti bagno.



STATUARIOSELECT  
Pure grace



GREYFLEURY  
Absolute rigour



NOIRSAINTLAURENT  
Intense emotion



TRAVERTINOSILVER  
Eternal allure



TRAVERTINOALABASTRINO  
Contemporary luxury



CREMODELICATO  
Refined nature





MARVEL  
PRO  
WALL  
DESIGN  
WHITE-BODY  
WALL TILES

Travertino Silver



## EXTREME BRILLIANCE

### BRILLANTEZZA ESTREMA

Noir Saint Laurent

**Transparent, intense and bright, the Marvel PRO walls feature a rich thickness of glaze that gives brilliance to the surface, making it glossy and reflective, the absolute protagonist of contemporary architecture. Each slab faithfully reproduces the details and graphic versatility of the natural material, for mirror-like walls rich in personality and expressive power.**

#### UN BRILLANT EXTRÊME

Transparents, profonds et lumineux, les revêtements Marvel PRO présentent une riche épaisseur d'émail qui apporte vitalité et brillant à la surface, en la rendant éclatante et réfléchissante, protagoniste absolue de l'architecture contemporaine. Chaque dalle reproduit scrupuleusement les détails et le graphisme varié de la matière d'inspiration, pour des parois réfléchissantes riches en personnalité et force expressive.

#### EXTREMER GLANZ

Transparent, tief und leuchtend, die Wandbeläge für Innenbereiche Marvel PRO weisen eine üppige Glasurschicht auf, die der Oberfläche Vitalität und Glanz verleiht und sie zum strahlenden und spiegelnden Protagonisten zeitgenössischer Architektur macht. Jede Platte ahmt sorgfältig die Details und die graphische Variabilität der Vorlage nach, für spiegelnde Wände voller Persönlichkeit und Ausdruckskraft.

#### BRILLO EXTREMO

Transparentes, profundos y luminosos, los revestimientos Marvel PRO presentan un rico espesor de esmalte que regala vitalidad y brillo a la superficie, volviéndola brillante y reflectante, protagonista absoluta de la arquitectura contemporánea. Cada losa reproduce escrupulosamente los detalles y la variabilidad gráfica del material de inspiración, para lograr paredes reflectantes ricas de personalidad y fuerza expresiva.

#### ИСКЛЮЧИТЕЛЬНЫЙ БЛЕСК

Обильный слой глазури придает поверхности настенной плитки Marvel PRO прозрачность, глубину, ослепительную яркость, превращая ее в центральный элемент дизайна. В каждой плитке детально передан естественно-неравномерный рисунок мрамора, благодаря которому стены приобретают роскошную выразительность.



## CUTTING EDGE SPECTACULAR EFFECTS

Marvel PRO includes an innovative three-dimensional finish in size 40x80 that adds great decorative potential to the marble-effect surfaces. Marvel PRO Ribbon represents a spectacular solution for walls with tremendous visual impact in which the natural material merges with sinuous waving in relief creating effects of light and shadow.

### DES SCÉNOGRAPHIES CONTEMPORAINES

Marvel PRO inclut une innovante finition tridimensionnelle au format 40x80 qui ajoute une grande force décorative aux surfaces imitation marbre. Marvel PRO Ribbon représente une solution scénographique pour des murs à fort impact esthétique où la matière d'inspiration se mêle aux vagues en relief en créant des jeux d'ombre et lumière spectaculaires.

### AKTUELLE SZENERIEN

Marvel PRO zeichnet sich aus durch eine innovative dreidimensionale Oberfläche im Format 40x80 die der Marmoroptik gestalterische Kraft verleiht. Marvel PRO Ribbon ist eine spektakuläre Lösung für Wände mit hoher ästhetischer Wirkung, wobei sich das Material der Vorlage mit den geschwungenen Wellen in Relief kombiniert und für eindrucksvolle Spiele von Licht und Schatten sorgt.

## SCENOGRAFIE ATTUALI

Marvel PRO include un'innovativa finitura tridimensionale in formato 40x80 che aggiunge una grande forza decorativa alle superfici effetto marmo. Marvel PRO Ribbon rappresenta una soluzione scenografica per pareti ad alto impatto estetico in cui la materia di ispirazione si sposa con sinuose onde a rilievo creando spettacolari giochi di luci e ombre.

### ESCENOGRAFÍAS ACTUALES

Marvel PRO incluye un innovador acabado tridimensional en formato 40x80 que añade una gran fuerza decorativa a las superficies efecto mármol. Marvel PRO Ribbon representa una solución escenográfica para paredes de elevado impacto estético en las que el material de inspiración se combina con sinuosas ondas en relieve creando espectaculares juegos de luces y sombras.

### АКТУАЛЬНЫЙ ДЕКОР

Коллекция Marvel PRO включает инновационную трехмерную поверхность форматом 40x80, придающую мраморной фактуре особый декоративный эффект. На плитках Marvel PRO Ribbon изящные рельефные волны рожают красочную игру света и тени, благодаря которой интерьер выглядит необычайно нарядно.



Grey Fleury Ribbon 40x80

Statuario Select Ribbon 40x80



# PRECIOUS DECORATIONS

## DECORAZIONI RICERCATE

The result of a careful research aimed at enhancing the aesthetic power of marble, the refined decor range, rich in modern and precious offers, multiplies the planning potential of the collection, for interior decoration in line with the latest contemporary trends.

Frutto di un'attenta ricerca volta a valorizzare la potenza estetica dei marmi di riferimento, la raffinata gamma decorativa, ricca di forme attuali e proposte preziose, moltiplica le possibilità progettuali della collezione, per una decorazione d'interni in linea con le tendenze contemporanee.



### DES DÉCORATIONS SOPHISTIQUÉES

Fruit d'une minutieuse recherche destinée à valoriser la puissance esthétique des marbres de référence, la gamme décorative raffinée, riche en formes actuelles et propositions précieuses, multiplie les solutions de conception de la collection, pour une décoration d'intérieur en accord avec les tendances contemporaines.

### AUSGESUCHTE DEKORE

Das Ergebnis umfangreicher Studien, um die ästhetische Kraft der Vorlagen zur Geltung zu bringen, während das raffinierte Dekorsortiment mit seinen aktuellen Formen und wertvollen Vorschlägen die Gestaltungsmöglichkeiten der Kollektion für Inneneinrichtungen im Einklang mit modernen Trends vervielfacht.

### DECORACIONES SOFISTICADAS

Fruto de una cuidadosa investigación orientada a revalorizar la potencia estética de los mármoles de referencia, la refinada gama decorativa, rica de formas actuales y propuestas valiosas, multiplica las posibilidades de proyección de la colección, para avien desea una decoración de interiores en sintonía con las tendencias contemporáneas.

### УТОНЧЕННЫЙ ДЕКОР

Плодом тщательных исследований является изысканная гамма декоративных элементов, чьи актуальные формы изящно подчеркивают эстетическое великолепие мраморной фактуры. Ценные декоры придают интерьерам современную стильность.





LEISURE  
CITY

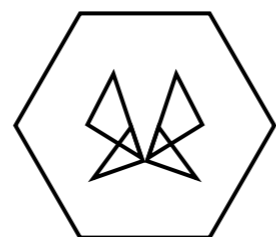

LEISURE CITY

## THE LUXURY OF HOSPITALITY



**Prestigious, comfortable and relaxing spaces: contemporary venues dedicated to welcoming the modern and cosmopolitan traveller that appreciates a unique and innovative experience.**

Luoghi prestigiosi, confortevoli e rilassanti: sono gli spazi contemporanei dedicati all'ospitalità di viaggiatori moderni e cosmopoliti, alla ricerca di un'esperienza unica e innovativa.

Des lieux prestigieux, confortables et relaxants : ce sont les espaces contemporains destinés à l'hospitalité des voyageurs modernes et cosmopolites, à la recherche d'une expérience unique et novatrice.

Lugares prestigiosos, confortables y relajantes: son los espacios contemporáneos dedicados a la recepción de los viajeros modernos y cosmopolitas, en búsqueda de una experiencia única e innovadora.

*Renommierter Orte, komfortabel und entspannend: zeitgenössische Räume in der Hotellerie für moderne und weltoffene Reisende, auf der Suche nach einer einzigartigen und innovativen Erfahrung.*

*Престижные, комфортные, уютные интерьеры: это современные пространства для космополитичных путешественников, ищущих новых, ярких впечатлений.*



BUSINESS CITY

## THE PRIVILEGE OF EXCLUSIVITY



**Top level architectural spaces that welcome business travellers with class, providing solutions that merge aesthetics, functionality and sought-after details.**

Spazi architettonici di alto livello accolgono con classe professionisti in viaggio d'affari, fornendo soluzioni che fondono estetica, praticità e passione per i dettagli.

Des espaces architecturaux de haut niveau accueillent avec classe des professionnels en voyage d'affaires, en leur offrant des solutions qui unissent l'esthétique, la praticité et la passion du détail.

Espacios arquitectónicos de alto nivel reciben con clase a profesionales en viaje de negocios, brindando soluciones que funden estética, practicidad y pasión por los detalles.

*Höchste Architektur, um stilvoll Geschäftsleute zu beherbergen, durch die Bereitstellung von Lösungen, die Ästhetik, Funktionalität und Liebe zum Detail kombinieren.*

*Элитные архитектурные пространства гостеприимно принимают деловых путешественников, окружая их красивой, практичной, ухоженной до мельчайших деталей обстановкой.*



BUSINESS  
CITY



MARVELPRO  
BUSINESS CITY

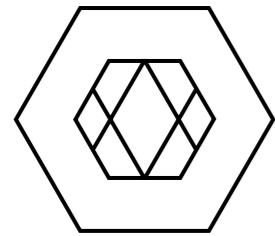

LUXURY HOTEL SUITE

# SPARKLING SHADES

TONALITÀ SCINTILLANTI

**In the colour palette, the intense Noir St. Laurent shade stands out and adorns floors and walls with exclusive luxury. This is due to its deep black background interrupted by white veins. The delicate combination with Crema Delicato gives life to a warm and elegant chromatic contrast. Important elements for refined, welcoming spaces.**

Nella palette cromatica spicca la profonda tonalità Noir St. Laurent che veste pavimenti e rivestimenti di un lusso esclusivo grazie al suo denso fondo scuro interrotto da venature bianche. Il raffinato abbinamento con Crema Delicato dà vita ad un contrasto cromatico caldo ed elegante, per ambienti dall'accoglienza esclusiva.

NOIRSAINTLAURENT & CREMODELICATO





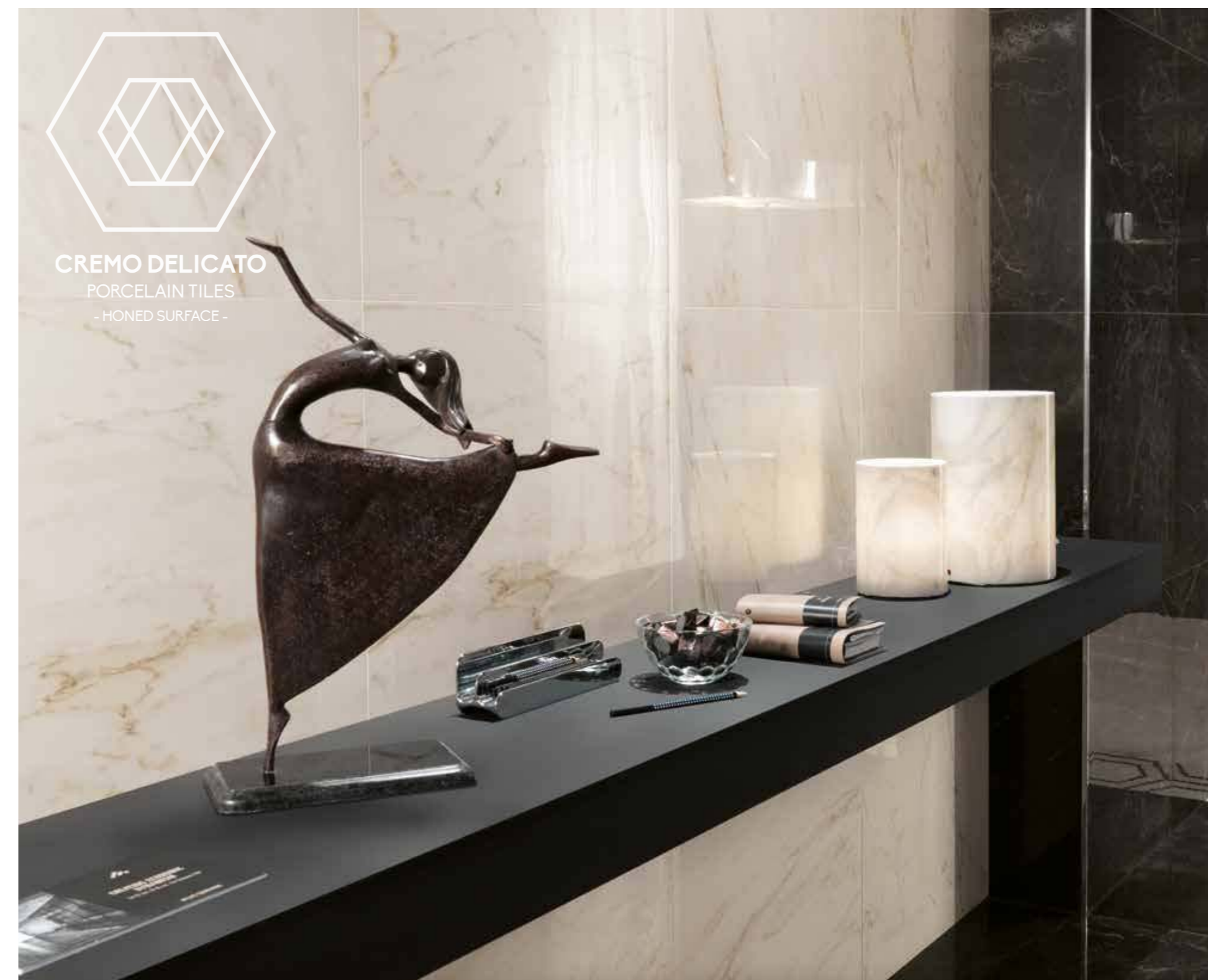

CREMO DELICATO  
PORCELAIN TILES  
- HONED SURFACE -

Dans la palette chromatique se distingue l'intense couleur du Noir St. Laurent qui habille les sols et les revêtements d'un luxe exclusif grâce à son fond sombre et dense sillonné de veines blanches. L'élégante combinaison avec Cremo Delicato offre un contraste chromatique chaud et élégant, pour des espaces d'une grâce exclusive.

*In der Farbpalette sticht der tiefe Farbton Noir St. Laurent hervor, der dank seines dichten dunklen Untergrunds, der von weißen Äderungen durchzogen wird Fußböden und Wände in einen exklusiven Luxus hüllt. Die raffinierte Kombination mit Cremo Delicato sorgt für einen warmen und eleganten Farbkontrast, für Ambiente von exklusiver Gastlichkeit.*

En la paleta cromática destaca la profunda tonalidad Noir St. Laurent que viste pavimentos y revestimientos de un lujo exclusivo interrumpido por vetas blancas. La refinada combinación con Cremo Delicato genera un contraste cromático cálido y a la vez elegante, para ambientes de recepción exclusivos.

*Темный, глубокий, насыщенный тон Noir St. Laurent, изобразженный белыми прожилками, покрывает полы и стены эксклюзивной роскошью. Изысканное сочетание с Cremo Delicato рождает элегантный контраст, наполняющий интерьер теплым уютом.*







**MARVEL<sup>PRO</sup> HONED FINISH**  
The surface maintains its original shine  
with no need for wax or polishing agents.

La superficie mantiene la brillantezza  
originaria anche senza cera o lucidante.

La surface maintient l'éclat  
d'origine même sans cire ou  
lustrant.

Die Oberfläche behält den  
ursprünglichen Glanz auch ohne  
Wachs oder Politur.

La superficie mantiene el brillo  
original incluso sin emplear  
cera o abrillantador.

Поверхность сохраняет свой  
первоначальный блеск без  
обработки восковыми или  
полирующими средствами.



**NOIR SAINT LAURENT**  
PORCELAIN TILES  
- HONED SURFACE -





## MARVELPRO DESIGN

- Porcelain Tiles
- Noir St. Laurent 60x60 cm Lappato
  - Crema Delicata 60x60 cm Lappato
  - Mosaico Honeycomb Warm 30x49 cm Lappato

## LUXURY HOTEL SUITE

MARVELPRO FLOOR DESIGN

PORCELAIN TILES

# MOSAICO HONEYCOMB

**A series of concentric hexagones alternate in appealing geometries.**  
 Una serie di esagoni concentrici si alternano in intriganti geometrie.

Une série d'hexagones concentriques s'alternent dans de surprenantes géométries.  
 Eine Reihe von konzentrischen Sechsecken, die sich in spannenden Formen abwechseln.  
 Una serie de hexágonos concéntricos se alternan en intrigantes geometrías.  
 Концентрические шестиугольники чередуются в интригующем геометричном рисунке.

COLOURS <

**Warm Lappato** (Crema Delicata + Noir St.Laurent)  
**Cold Lappato** (Statuario Select + Noir St.Laurent)



Mosaico Honeycomb Warm 30x49 cm Lappato



MARVELPRO  
LEISURE CITY

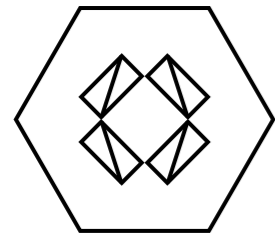

LUXURY SUITE BATHROOM

# PURE RELAXATION

PURO RELAX

Inspired by six natural marble types, Marvel PRO is the perfect solution for complete projects and elegant chromatic contrasts. The combination of Crema Delicata and Noir St. Laurent enhances bathrooms with a captivating appeal. The brilliant bathroom walls are characterized by a thick layer of glaze that creates a blend of glossy and mirror-like surfaces.

Ispirata a sei riferimenti naturali, Marvel PRO è ideale per progetti completi e per eleganti contrasti cromatici: l'accostamento di Crema Delicata e Noir St. Laurent impreziosisce bagni dall'atmosfera accattivante. I brillanti rivestimenti bagno si distinguono per un ricco spessore di smalto che crea superfici lucide e riflettenti.

CREMDELICATO & NOIRSAINTLAURENT





## LUXURY SUITE BATHROOM



Inspirée à six références naturelles Marvel PRO est idéal pour des projets complets et d'élégants contrastes chromatiques : la combinaison de Crema Delicato et Noir St. Laurent sublime les salles de bain à l'atmosphère captivante. Les revêtements de salle de bain lumineux se distinguent pour leur riche épaisseur d'émail qui crée des surfaces brillantes et réfléchissantes.

*Inspiriert von sechs natürlichen Vorlagen ist Marvel PRO ideal für komplette Lösungen und für eindrucksvolle Farbkontraste: die Kombination von Crema Delicato und Noir St. Laurent schafft in jedem Badezimmer eine ansprechende Atmosphäre. Die strahlenden Wandbeläge im Badezimmer zeichnen sich durch eine reichhaltige Glasurschicht aus, die für glänzende und reflektierende Oberflächen sorgt.*

Inspirada en seis referencias naturales, Marvel PRO es ideal para proyectos completos y para crear elegantes contrastes cromáticos: la combinación de Crema Delicato y Noir St. Laurent aporta una atmósfera cautivante a los baños. Los brillantes revestimientos de baño se caracterizan por un rico espesor de esmalte que crea superficies lucientes y reflectantes.

*Коллекция Marvel PRO имитирует шесть ценных пород мрамора и позволяет составлять элегантные цветовые контрасты. Сочетание Crema Delicato и Noir St. Laurent создает в ванной комнате чарующую атмосферу. Обильный слой глазури придает поверхности настенной плитки для ванной ослепительную яркость и глубину.*



**NOIR SAINT LAURENT**  
WHITE-BODY WALL TILES





**CREMO DELICATO**  
PORCELAIN TILES  
- HONED SURFACE -



**MARVELPRO FLOOR&WALL**  
**Resistant to common chemical agents.**  
Resiste all'azione degli agenti chimici più comuni.

Résiste à l'action des agents chimiques les plus communs.

Beständig gegen die Wirkung der gängigsten Chemikalien.

Resistente a la acción de los agentes químicos más comunes.

Стойкость к наиболее распространенным химическим веществам.





CREMO DELICATO  
WHITE-BODY WALL TILES





White body wall tiles

- Crema Delicato 40x80 cm
- Noir St. Laurent 40x80 cm
- Noir St. Laurent Mosaic 30,5x30,5 cm
- Crema Mix Diagonal Mosaic 30,5x30,5 cm

Porcelain tiles

- Crema Delicato 60x60 cm Lappato
- Noir St. Laurent 60x60 cm Lappato

Trim Tiles

- Crema Delicato Spigolo 0,85x30,5 cm
- Noir St. Laurent Spigolo 0,85x30,5 cm



# MIX DIAGONAL MOSAIC

The timeless charm of black and white gives life to a refined mosaic with a strong visual impact.

L'intramontabile fascino del bianco e nero dà vita a un mosaico di grande raffinatezza e forte impatto scenografico.

L'éternel charme du noir et blanc donne vie à une mosaïque de grande élégance et d'un fort impact scénographique.

Die zeitlose Anziehungskraft von Schwarz und Weiß schafft ein Mosaik von großer Raffinesse und starker optischer Wirkung.

El impecadero encanto de la combinación de blanco y negro da vida a un mosaico de gran refinamiento e impacto escenográfico.

Неувядаемое очарование белого и черного цветов рождает изысканный и роскошный мозаичный декор.

COLOURS <

- Crema Mix (Crema Delicato + Noir St. Laurent)
- Noir Mix (Noir St. Laurent + Statuario Select)



Crema Mix Diagonal Mosaic 30,5x30,5 cm



MARVEL<sup>PRO</sup>  
LEISURE CITY

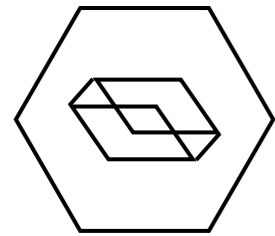

INTERNATIONAL HUB

Gallery hall

# TOTAL BRILLIANCE

SPLENDORE TOTALE

**The broad range of sizes of Marvel PRO in marble-effect porcelain tiles extends up to the 75x150 size for the utmost creative freedom. From the merger of Grey Fleury and Statuario Select intense and luminous spaces come to life, while Marvel PRO Macchia Aperta covers surfaces with tremendous visual impact.**

La vasta gamma di formati di Marvel PRO in gres porcellanato effetto marmo si estende fino al 75x150 enfatizzando la libertà compositiva in ogni contesto. Dall'incontro di Grey Fleury e Statuario Select scaturiscono ambienti intensi e luminosi, mentre Marvel PRO Macchia Aperta riveste superfici dal deciso impatto estetico.

GREYFLEURY & STATUARIOSELECT



Porcelain tiles

Grey Fleury 75x150 cm Lappato |

Statuario Select 75x150 cm Lappato |

Statuario Select Macchia Aperta 75x150 cm Lappato |





La vaste gamme de formats de Marvel PRO en grès cérame imitation marbre s'étend jusqu'au format 75x150, augmentant ainsi la liberté de composition dans chaque contexte. La combinaison de Grey Fleury et Statuario Select crée des espaces intenses et lumineux, tandis que Marvel PRO Macchia Aperta habille des surfaces d'un impact esthétique décisif.

*Das breite Formatsortiment von Marvel PRO in Feinsteinzeug mit Marmor-Optik reicht bis zum 75x150 und betont die gestalterische Freiheit in jedem Kontext. Aus der Begegnung Grey Fleury und Statuario Select ergeben sich intensive und helle Ambiente, während Marvel PRO Macchia Aperta den Oberflächen eine klare ästhetische Wirkung verleiht.*

La vasta gama de formatos de Marvel PRO en Gres porcelánico efecto mármol abarca hasta el 75x150 enfatizando la libertad de composición en cualquier contexto. Del encuentro de Grey Fleury y Statuario Select surgen ambientes intensos y luminosos, mientras Marvel PRO Macchia Aperta reviste superficies de decidido impacto estético.

*Керамогранитные плитки под мрамор Marvel PRO охватывают обширную гамму форматов, вплоть до 75x150, для самых разнообразных композиционных решений. Сочетание тонов Grey Fleury и Statuario Select озаряет интерьер насыщенным светом, а Marvel PRO Macchia Aperta придает поверхностям эстетичную стильность.*

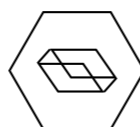

**MARVELPRO MACCHIA APERTA**  
**Inspired by Macchia Aperta marble,**  
**the specular veining creates amazing**  
**geometrical effects.**

Ispirato alle lastre di marmo a Macchia Aperta: le venature, disposte in modo speculare, creano scenografici effetti geometrici.

Inspiré aux dalles de marbre à Macchia Aperta : les veines, disposées façon miroir, créent des scénographiques aux effets géométriques.

Inspiriert von den Marmorplatten des Macchia Aperta: durch die spiegelbildlich angeordneten Äderungen entstehen spektakuläre geometrische Effekte.

Inspirado en las losas de mármol Macchia Aperta: las vetas, dispuestas en modo especular, crean escenográficos efectos geométricos.

В декоративном элементе Macchia Aperta зеркально расположенные прожилки рождают восхитительный геометрический эффект.



MARVELPRO  
LEISURE CITY

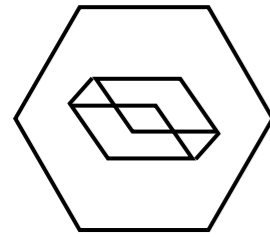

### INTERNATIONAL HUB

Showroom space

**The extra glossy honed finish used on floors and walls brightens the atmosphere thanks to its mirror-like surface that faithfully reproduces the splendour of polished marble. The large 75x150 size, available in all colours of the collection, broadens the perspective of large-scale commercial projects.**

La lucidissima finitura lappata, usata in continuità per pavimenti e rivestimenti, illumina l'atmosfera con la sua superficie specchiante che riproduce fedelmente lo splendore dei marmi levigati. Il grande formato 75x150, disponibile in tutti i colori della collezione, amplia la prospettiva di spazi commerciali di grandi dimensioni.

GREYFLEURY & STATUARIOSELECT







La finition adoucie très brillante, utilisée en continuité pour les sols et revêtements, illumine l'atmosphère à travers sa surface réfléchissante qui reproduit fidèlement la splendeur des marbres polis. Le grand format 75x150, disponible dans toutes les couleurs de la collection, élargit la perspective des espaces commerciaux de grandes tailles.

*Die glänzende geläppte Ausführung, durchgehend für Fußböden und Wände eingesetzt, erhellt die Atmosphäre mit ihrer spiegelnden Oberfläche, die naturgetreu den Glanz von poliertem Marmor nachempfunden. Das Großformat 75x150, verfügbar in allen Farben der Kollektion, erweitert die Perspektive von großen Gewerberäumen.*

El lucentísimo acabado pulido, usado en sendos pavimentos y revestimientos, ilumina la atmósfera con su superficie reflectante que reproduce fielmente el esplendor de los mármoles bruñidos. El gran formato 75x150, disponible en todos los colores de la colección, amplía la perspectiva de espacios comerciales de gran tamaño.

*Лаппатированная поверхность керамогранита, уложенного на полы и стены, имеет такой же зеркальный блеск, как у полированного мрамора. Большой формат 75x150, доступный во всех цветах коллекции, зрительно раздвигает пространство торгового интерьера.*

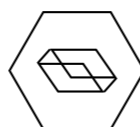

**GREY FLEURY**  
PORCELAIN TILES  
- HONED SURFACE -  
75x150





## MOSAICO ESAGONO MULTICOLOR

**A set of three rhombus shapes of different colours creates a modern, three-dimensional optical look.**

Terne di rombi di diversa tonalità creano un effetto ottico moderno e tridimensionale.

Des ensembles de trois losanges de différentes couleurs créent un effet optique moderne et tridimensionnel.

Sets von Rauten in verschieden Farbabstufungen schaffen einen modernen und dreidimensionalen optischen Effekt.

Ternas de rombos de diversas tonalidades crean un efecto óptico moderno y tridimensional.

Тройки ромбов разных оттенков создают современный трехмерный оптический эффект.

COLOURS <

**Multicolor Cold** (Statuario Select + Grey Fleury + Noir St.Laurent)

**Multicolor Warm** (Crema Delicato + Travertino Alabastrino + Noir St.Laurent)



Mosaico Esagono Multicolor Cold 30x35 cm

**MARVELPRO FLOOR&WALL**  
**Guarantees the maximum simplicity of maintenance. Perfect for public spaces as well as the workplace.**

Garantisce la massima semplicità di manutenzione. Perfetto per spazi pubblici e luoghi di lavoro.

Garantit la simplicité d'entretien maximale. Parfait pour des espaces publics et des lieux de travail.

Bietet maximale Pflegeleichtigkeit. Perfekt für öffentliche Bereiche und Arbeitsstätten.

Garantiza la máxima sencillez de manutención. Perfecto para espacios públicos y lugares de trabajo.

Максимальная простота ухода. Идеально для общественных пространств и рабочих мест.



# MOSAICO ESAGONO

**A carpet motif with rhombus shapes creates a hexagonal geometrical effect, which is enhanced by the direction of veining.**

Tappeto di rombi delinea giochi geometrici dalla forma esagonale, esaltati dalla direzione delle venature.

Un tapis de losanges profile des jeux géométriques d'une forme hexagonale, sublimés par la direction des veines.

Eine Bordüre aus Rauten schafft geometrische Spiele in sechseckiger Form, die durch den Verlauf der Äderungen betont werden.

Una alfombra de rombos delinea juegos geométricos de forma hexagonal, destacados por la dirección de las vetas.

Маленькие ромбы выстраиваются в гексагональный узор, подчеркнутый направленным прожилковым рисунком.

**COLOURS <**  
All colours available



Grey Fleury Mosaico Esagono 30x35 cm Lappato

## Porcelain tiles

- Grey Fleury 75x150 cm Lappato
- Statuario Select 60x60 cm Lappato
- Statuario Select Mosaico Esagono 30x35 cm Lappato
- Grey Fleury Mosaico Esagono 30x35 cm Lappato
- Mosaico Esagono Multicolor Cold 30x35 cm Lappato





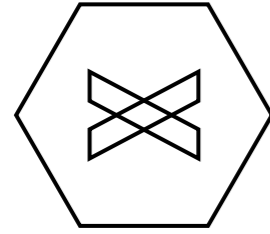

WELLNESS CENTER

## EXCLUSIVE REGENERATION

ESCLUSIVA RIGENERAZIONE

The bathroom walls in white-body ceramics evoke the details, shades and graphics of natural marble. Ideal for beautiful wellness areas that require high technical standards. The Grey Fleury colour, in size 40x80 for walls and with matt finish for floors, is combined with Statuario Select, which is available in a textured version for a safe and anti-slip passageway.

I rivestimenti bagno in pasta bianca evocano i dettagli, le sfumature e la variabilità grafica dei marmi naturali, per spazi benessere di assoluto pregio estetico e tecnico. La tonalità Grey Fleury, proposta a parete nel formato 40x80 e a pavimento in finitura matt, è accostata allo Statuario Select, scelto in versione strutturata per un corridoio sicuro e antiscivolo.

GREYFLEURY & STATUARIOSELECT





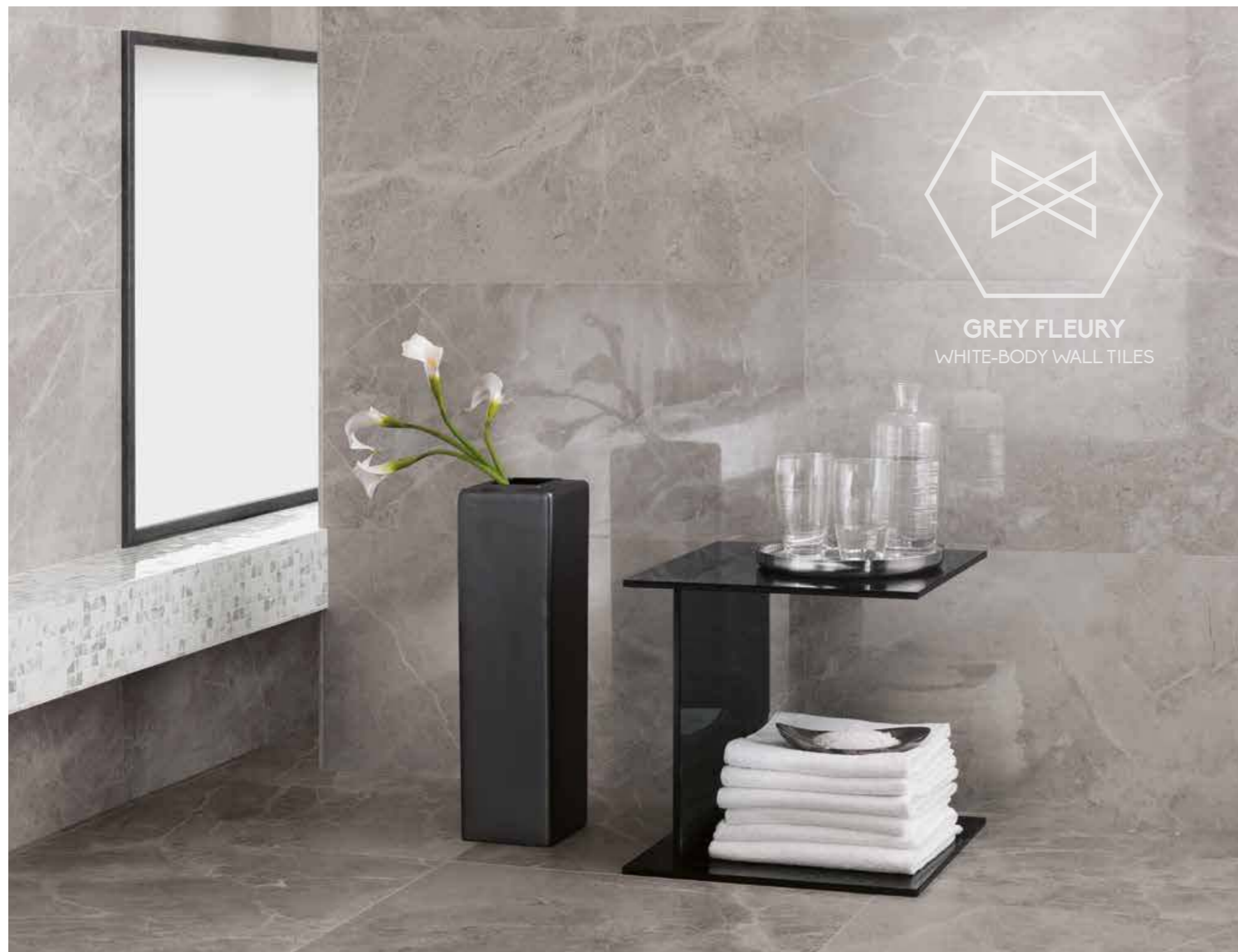

Les revêtements de salle de bain en pâte blanche évoquent les détails, les nuances et la variabilité graphique des marbres naturels, pour des espaces bien-être d'un prestige esthétique et technique absolu. La couleur Grey Fleury, proposée au mur au format 40x80 et au sol dans une finition mate, est juxtaposée au Statuario Select, choisi en version structurée pour un couloir sécurisé et antidérapant.

*Die Badezimmerwandfliesen aus weißer Tonmasse erinnern an die Details, die Nuancen und die graphische Variabilität der natürlichen Marmorarten für Räume des Wohlbefindens von absolutem ästhetischem und technischem Wert. Der Farbton Grey Fleury, als Wandbelag im Format 40x80 und als Fußboden in der Oberfläche matt, wird in der strukturierten Version von Statuario Select für einen sicheren und rutschhemmenden Flur kombiniert.*

Los revestimientos de baño en pasta blanca evocan los detalles, los matices y la variabilidad gráfica de los mármoles naturales, creando espacios de bienestar de absoluto valor estético y técnico. La tonalidad Grey Fleury, propuesta para la pared en el formato 40x80 y para el pavimento en acabado opaco, es acompañada por Statuario Select, seleccionado en la versión estructurada para obtener un pasillo seguro y con propiedades antideslizamiento.

*Настенная плитка из белой глины в мельчайших деталях воспроизводит оттенки и рисунок природного мрамора, придавая величественным пространствам красивый внешний вид и обеспечивая высокие технические характеристики поверхностей. Тон Grey Fleury, уложенный на стенах в формате 40x80 и на полах в матовом варианте, стильно соседствует с оттенком Statuario Select, чья структурная поверхность делает полы в коридорах нескользкими и безопасными.*







**MARVEL<sup>PRO</sup> NET MOSAIC**  
Elegant intertwining of glossy and satin inserts.

Elegante intreccio di tessere lucide e satiniate.

Un entrelac élégant de tesselles brillantes et satinées.

Elegante Verflechtung von glänzenden und satinierten Steinen.

Elegante trama de teselas lucientes y satinadas.

Эlegantное переплетение блестящих и сатирированных элементов.

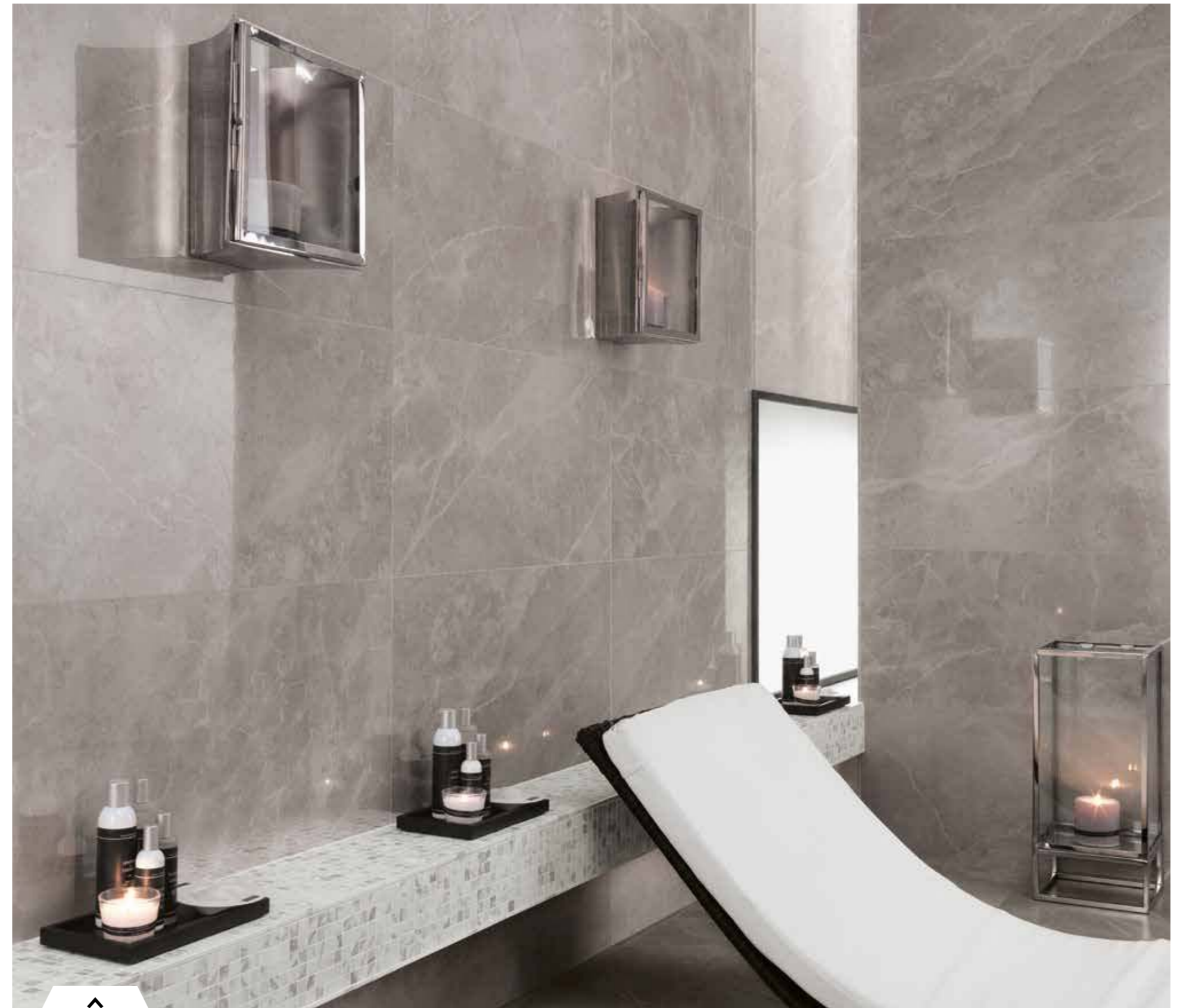

**MARVEL<sup>PRO</sup> FLOOR&WALL**  
Impermeable to water and humidity, which makes it suitable for wellness centres and SPAS.

Resistente all'acqua e all'umidità, è ideale per centri benessere e SPA.

Résistant à l'eau et à l'humidité, il est idéal pour des centres de bien-être et SPA.

Wasserfest und feuchtigkeitsresistent, somit ideal für Wellness- und SPA-Zentren.

Resistente al agua y a la humedad, es ideal para centros de bienestar y balnearios.

Стойкость к воде и влаге: идеально для велнес- и СПА-центров.





GREY FLEURY  
PORCELAIN TILES  
- MATT SURFACE -

**MARVEL<sup>PRO</sup> TEXTURED FINISH**  
The textured surface creates safe anti-slip passageways for humid areas in SPA and wellness centres.

Lo strutturato crea sicuri camminamenti antiscivolo perfetti per le zone umide delle SPA.

La version structurée crée des allées sûres et antidérapantes, parfaites pour les zones humides des SPA.

Die strukturierte Version schafft sichere, rutschhemmende Wege und ist somit ideal für Feuchträume in SPA-Bereichen.

El estructurado crea seguras marcas antideslizamiento perfectas para las zonas húmedas de los SPA.

Структурная плитка образует нескользкие дорожки во влажных зонах СПА-центров.

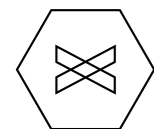





**GREY FLEURY RIBBON**  
WHITE-BODY WALL TILES



## MARVELPRO DESIGN

### White body wall tiles

- Grey Fleury 40x80 cm
- Grey Fleury Ribbon 40x80 cm
- Grey Fleury Net Mosaic 30,5x30,5 cm
- Statuario Select Mosaic 30,5x30,5

### Porcelain tiles

- Grey Fleury 60x60 cm Matt
- Statuario Select 30x60 cm Strutturato

### Trim Tiles

- Statuario Select Spigolo 0,85x30,5 cm
- Grey Fleury Spigolo 0,85x30,5 cm

## WELLNESS CENTER

## MARVELPRO 3D WALL DESIGN

WHITE-BODY WALL TILES

# RIBBON 40x80 cm

**Three-dimensional walls sculpted by the soft and sinuous waved effect of a Ribbon.**

Pareti tridimensionali scolpite dal morbido e sinuoso effetto ondulato di Ribbon.

Des murs tridimensionnels sculptés par l'effet onduleux, souple et sinueux de Ribbon.

Dreidimensionale Wände, weich und gewunden, mit dem Welleneffekt von Ribbon.

Paredes tridimensionales esculpidas por el suave y sinuoso efecto ondulado de Ribbon.

Трёхмерные стены, украшенные мягким волнистым рельефом Ribbon.

COLOURS <

Statuario Select, Grey Fleury, Noir St. Laurent, Crema Delicato



Grey Fleury Ribbon 40x80 cm



MARVEL<sup>PRO</sup>  
LEISURE CITY

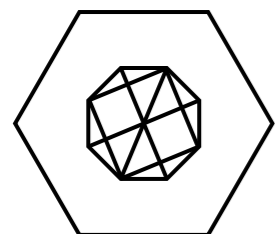

SPA & RELAX ROOM

## NATURAL LOOK

LOOK NATURALE

**In Statuario Select 60x60, the satin finish adorns the space with a refined honed finish in porcelain stoneware with a satin appearance that is velvety to the touch. In turn, gives contemporary spaces a sense of naturalness exalting the original material of inspiration.**

Declinata in tonalità Statuario Select 60x60, la finitura satin veste l'ambiente con una raffinata superficie lappata in gres porcellanato dall'aspetto satinato e vellutato al tatto, che conferisce a spazi dal carattere contemporaneo un profondo senso di naturalezza, mettendo in risalto la materia d'ispirazione.

STATUARIOSELECT  
SATIN







STATUARIO SELECT  
PORCELAIN TILES  
- SATIN SURFACE -



Déclinée dans la couleur Statuario Select 60x60, la finition satin habille l'espace avec une élégante surface adoucie en grès cérame à l'aspect satiné et velouté au toucher, qui suscite dans les espaces contemporains une profonde sensation de nature, en exaltant la matière d'inspiration.

Angeboten im Farbton Statuario Select 60x60 gestaltet die satinierte Ausführung Ambiente mit einer raffinierten geläpften Oberfläche aus Feinsteinzeug in matter und samtweicher Optik, welche den Räumen einen modernen Charakter mit tiefem Sinn für Natürlichkeit verleiht und die Materialvorlage zur Geltung bringt.

Presentado en la tonalidad Statuario Select 60x60, el acabado satinado viste el ambiente con una refinada superficie pulida en gres porcelánico de aspecto terso y aterciopelado al tacto, que confiere a espacios de carácter contemporáneo un profundo sentido de naturalidad, dando relevancia a la materia de inspiración.

Лаппатированный керамогранит Statuario Select 60x60 с мягкой на ощупь сатирированной поверхностью, изящно подчеркивающей фактуру мрамора, придает современным пространствам изысканный натуральный вид.

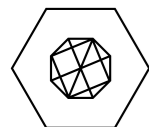





**MARVEL<sup>PRO</sup> SATIN FINISH**  
**An extraordinary light effect, soft and**  
**consuming, enhancing walls and floors**  
**with sought-after atmospheres.**

Uno straordinario effetto luce, morbido e avvolgente, invade pareti e pavimenti, per ricercate atmosfere.

Un extraordinaire effet lumière, doux et enveloppant, envahit murs et sols, pour des atmosphères raffinées.

Ein außerordentlicher Lichteffect, weich und behaglich, dringt in Wände und Böden und sorgt für eine anspruchsvolle Atmosphäre.

Un extraordinario efecto de luz, suave y envolvente, invade paredes y pavimentos, creando elegantes atmósferas.

Изумительный мягкий свет заливает полы и стены, рождая изысканную атмосферу.

Porcelain tiles

■ Statuario Select 60x60 cm Satin





MARVEL<sup>PRO</sup>  
BUSINESS CITY

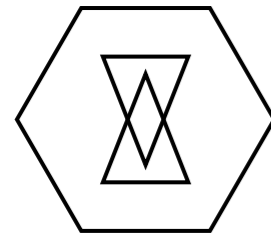

FOOD COURT

## RIGOROUS DESIGN

DESIGN RIGOROSO

**The matt finish is perfect for public spaces and commercial venues subject to moderate foot traffic, such as the modern areas of hospitality and restaurants characterized by a contemporary and minimalist design. The textured surface can be used on walls as a decorative element, bestowing walls with a strong and powerful appeal.**

La finitura matt, è ideale per spazi pubblici e ambienti commerciali a medio traffico come i moderni contesti dedicati all'ospitalità e alla ristorazione dal design contemporaneo ed essenziale. La superficie strutturata può essere usata a rivestimento con valenza decorativa, donando alla parete potenza e vigore espressivo.

GREYFLEURY & STATUARIOSELECT







**GREY FLEURY**  
PORCELAIN TILES  
- MATT SURFACE -

La finition mate est idéale pour des espaces publics et commerciaux moyennement fréquentés, comme les contextes modernes dédiés à l'hospitalité et à la restauration au design contemporain et essentiel. La surface structurée peut être utilisée comme revêtement de décoration, pour apporter au mur force et vigueur d'expression.

*Die matte Ausführung ist ideal für öffentlichen Bereiche und Gewerbeumgebungen mit mittlerer Beanspruchung, wie auch in modernen Kontexten für Hotellerie und Gastronomie in zeitgenössischem und wesentlichem Design. Die strukturierte Oberfläche kann als dekorativer Wandbelag verwendet werden, der den Wänden eine expressive Kraft und ein hohes gestalterisches Potential verleiht.*

El acabado opaco, es ideal para espacios públicos y ambientes comerciales sometidos a un tránsito medio como los modernos contextos dedicados a la hospitalidad y a la restauración de diseño contemporáneo y esencial. La superficie estructurada puede ser empleada como revestimiento con valencia decorativa, donando a la pared potencia y vigor expresivo.

*Матовая поверхность идеальна для общественных и коммерческих объектов со средней интенсивностью эксплуатации, таких как гостиницы или рестораны. Структурные плитки придают стенам выразительную декоративность, а интерьерам в целом – лаконичный современный вид.*







**GREY FLEURY**  
PORCELAIN TILES  
- TEXTURED SURFACE -

**MARVEL<sup>PRO</sup> TEXTURED FINISH**  
The textured finish on walls creates a decorative solution with tremendous appeal.

A parete lo strutturato crea soluzioni decorative dal grande impatto estetico.

Au mur, le structuré crée des solutions décoratives d'un grand impact esthétique.

An der Wand schafft die strukturierte Version dekorative Lösungen von hoher ästhetischer Wirkung.

En pared el acabado estructurado crea soluciones decorativas de gran impacto estético.

Структурные плитки придают стенам эффектную декоративность.







**STATUARIO SELECT**  
PORCELAIN TILES  
- MATT SURFACE -



**MARVELPRO FLOOR&WALL**

**The surface does not emit hazardous substances and does not release volatile organic compounds (VOC).**

La superficie non emette sostanze nocive e non rilascia composti organici volatili (VOC).

La surface n'émet pas de substances nocives et ne libère pas de composés organiques volatiles (VOC).

Setzt keine gesundheitsschädlichen Substanzen und keine flüchtigen organische Verbindungen (VOC) frei.

La superficie non emana sustancias nocivas y non despidе compuestos orgánicos volátiles (VOC).

Поверхность не выделяет опасных веществ и летучих органических соединений (ЛОС).

**MARVELPRO DESIGN**

**FOOD COURT**

**Porcelain tiles**

- Grey Fleury 45x90 cm Matt
- Statuario Select 45x90 cm Matt
- Grey Fleury 30x60 cm Strutturato
- Bord Liquorice 22,5x90 cm Matt





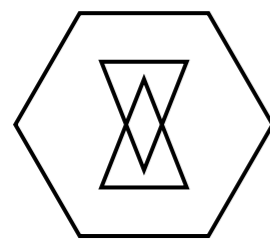

**OUTDOOR DINING**

The textured finish, available in size 30x60 and in Lastra 20mm in 60x60 and 45x90 sizes, combines the aesthetics of marble and the advantages of a slip-resistant surface that is also resistant to frost and thermal shock. Making it an ideal surface for outdoor spaces and other areas requiring special technical performance.

In esterno e nelle zone che richiedono prestazioni tecniche elevate, la finitura strutturata, disponibile nel formato 30x60 e nella versione LASTRA 20mm in 60x60 e 45x90, unisce l'estetica del marmo ai vantaggi di una superficie ingeliva, antiscivolo e in grado di resistere agli sbalzi di temperatura.

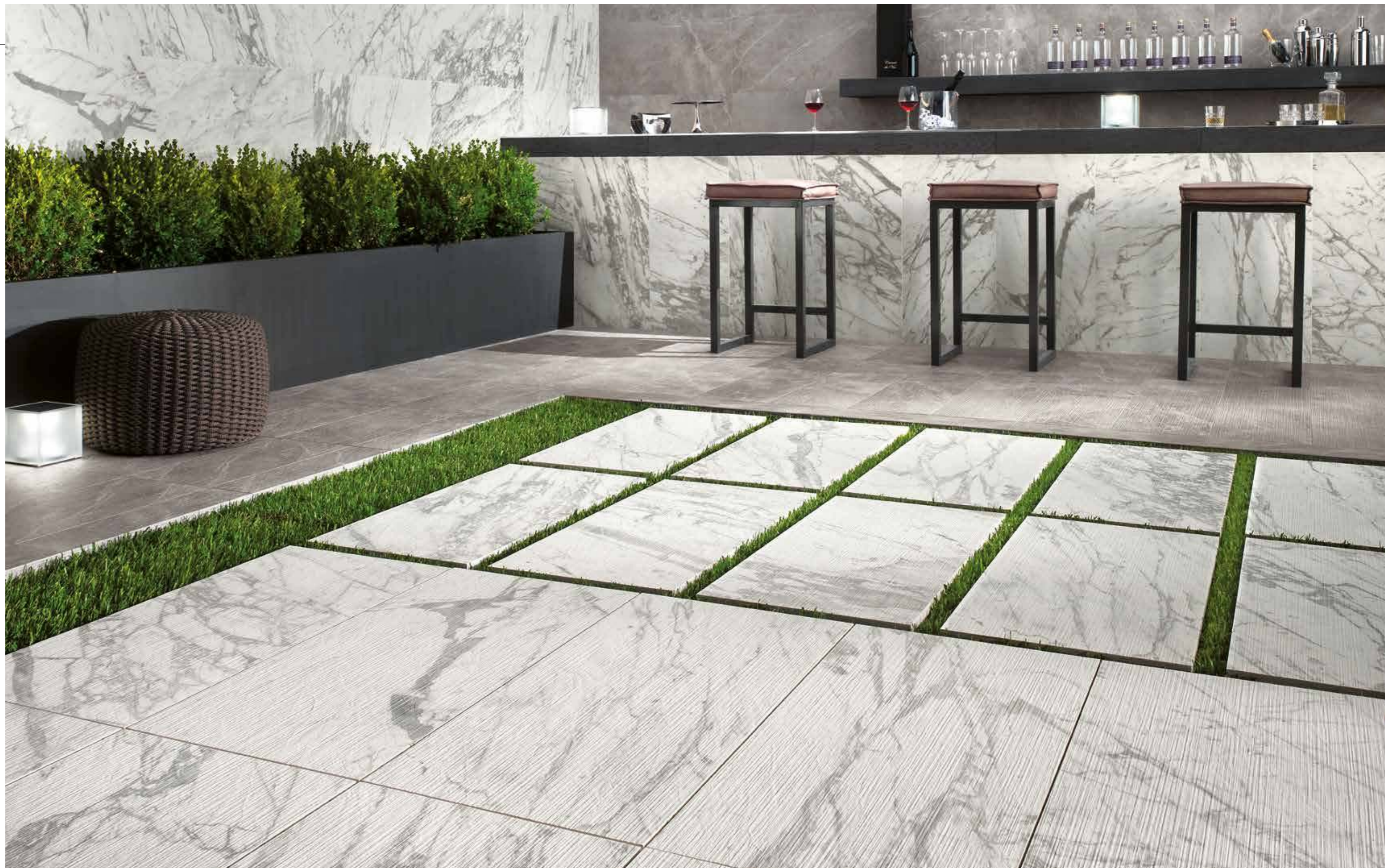





**GREY FLEURY**  
PORCELAIN TILES  
- TEXTURED SURFACE -

À l'extérieur et dans les zones qui exigent des prestations techniques élevées, la finition structurée, disponible au format 30x60 et dans la version Lastra 20mm en 60x60 et 45x90, unit l'esthétique du marbre aux avantages d'une surface résistante au gel, antidérapante et capable de résister aux écarts de température.

*Im Außenbereich und in Bereichen, die hohe technische Leistungen erfordern kombiniert die strukturierte Ausführung, erhältlich im Format 30x60 und in der Version Lastra 20mm in 60x60 und 45x90, die Ästhetik von Marmor mit den Vorteilen einer frostsicheren, rutschhemmenden und temperaturbeständigen Oberfläche.*

En exteriores y en las zonas que requieren características técnicas elevadas, el acabado estructurado, disponible en el formato 30x60 y en la versión Lastra 20mm en 60x60 y 45x90, une la estética del mármol con las ventajas de una superficie resistente al hielo, antideslizamiento y capaz de soportar los cambios bruscos de temperatura.

*На улице и в местах, требующих от покрытий особенно высоких технических характеристик, структурные плитки, доступные в формате 30x60 и в варианте Lastra 20mm 60x60 и 45x90, обеспечивают высокую стойкость к скольжению, морозам, температурным перепадам.*







**STATUARIO SELECT**  
PORCELAIN TILES  
- LASTRA 20MM -

**MARVELPRO LASTRA 20 MM**  
Featuring the same three-dimensional relief of the textured finish, it is easy to install onto grass, gravel and sand.

Con lo stesso rilievo tridimensionale dello strutturato, è facile da posare in applicazioni a secco su erba, ghiaia e sabbia.

Avec le même relief tridimensionnel du structuré, il est facile à poser dans des applications à sec sur gazon, gravier et sable.

Mit dem gleichen dreidimensionalen Relief der strukturierten Version ist die trockene Verlegung auf Gras, Kies und Sand ganz einfach durchzuführen.

Con el mismo relieve tridimensional del estructurado, es fácil de colocar en aplicaciones en seco sobre césped, grava y arena.

Плитки LASTRA 20mm со структурной поверхностью можно укладывать всухую на траву, гравий, песок.

## MARVELPRO DESIGN

## FOOD COURT

### Porcelain tiles

- Statuario Select 45x90 cm Matt
- Grey Fleury 45x90 cm Matt
- Statuario Select 45x90 cm LASTRA 20mm
- Grey Fleury 30x60 cm Strutturato
- Grey Fleury Elemento L 15x60 cm Strutturato
- Bord Liquorice 22,5x90 Matt





MARVEL<sup>PRO</sup>  
BUSINESS CITY

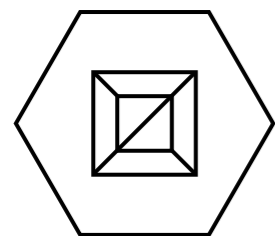

CORPORATE LOUNGE

## REFINED CONTRAST

CONTRASTI RICERCATI

**Thanks to elegant combinations and chromatic contrasts, Marvel PRO means being able to decorate the space with installation patterns of timeless charm. From the mix of intense Noir St. Laurent and the pure Statuario Select shades, black and white refined combinations stand out. Marvel PRO Ribbon in vertical installation enriches the spaces with its sinuous waves in relief.**

Grazie a eleganti abbinamenti e contrasti cromatici, Marvel PRO consente di arredare gli spazi con schemi di posa ornamentali dal fascino senza tempo. Accostando il profondo Noir St. Laurent e il purissimo Statuario Select, si creano combinazioni in bianco e nero di grande raffinatezza. Marvel PRO Ribbon in posa verticale arricchisce l'ambiente con le sue onde sinuose a rilievo.

STATUARIOSELECT & NOIRSAINTLAURENT







STATUARIO SELECT  
NOIR SAINT LAURENT  
PORCELAIN TILES  
- HONED SURFACE -



Grâce à d'élégantes combinaisons et contrastes chromatiques, Marvel PRO permet de décorer les espaces avec des schémas de pose ornementaux au charme intemporel. En unissant la profondeur du Noir St. Laurent et la pureté du Statuario Select, se créent des combinaisons en noir et blanc de grande élégance. Marvel PRO Ribbon en pose verticale enrichit l'espace avec ses vagues sinuoses en relief.

*Dank eleganter Kombination und Farbkontraste gestaltet Marvel PRO die Räume mit ornamentalen Verlegeschemata von zeitlosem Charme. Mit Noir St. Laurent und dem reinen Statuario Select entstehen Schwarz-Weiß-Kombinationen von großer Raffinesse. Marvel PRO Ribbon in vertikaler Verlegung bereichert die Ambiente mit geschwungenen Relief-Wellen.*

Gracias a elegantes combinaciones y contrastes cromáticos, Marvel PRO permite decorar los espacios con esquemas de colocación ornamentales de encanto intemporal. Uniendo el profundo Noir St. Laurent y el purísimo Statuario Select, se crean combinaciones en blanco y negro de gran elegancia. Marvel PRO Ribbon en colocación vertical enriquece el ambiente con sus ondas sinuosas y en relieve.

*Эlegantные комбинации и цветовые контрасты Marvel PRO позволяют создавать при укладке великолепный орнаментальный рисунок. Глубокий оттенок Noir St. Laurent и чистейший Statuario Select образуют изысканный черно-белый декор. Вертикальная укладка Marvel PRO Ribbon обогащает пространство рельефным волнистым мотивом.*





**MARVELPRO HONED FINISH**  
Brilliant surface protected by stain-resistant properties.  
Superficie brillante protetta da trattamenti antimacchia.

Surface brillante protégée par des traitements anti-tâche.

Glänzende Oberfläche durch anti Flecken-Behandlungen geschützt.

Superficie brillante protegida por tratamientos antimancha.

Блестящая поверхность с пятноотталкивающей обработкой.



**STATUARIO SELECT**  
WHITE-BODY WALL TILES

**MARVELPRO WALL**  
The abundant thickness of the glaze bestows brilliance and depth to the surface.  
Il ricco spessore di smalto conferisce brillantezza e profondità alla superficie.

La riche épaisseur d'émail apporte brillance et profondeur à la surface.

Die reichliche Dicke der Glasur verleiht der Oberfläche Glanz und Tiefe.

El abundante espesor de esmalte confiere brillo y profundidad a la superficie.

Большая толщина глазури придает поверхность блеск и глубину.





**MARVELPRO RIBBON**  
**Ideal for large walls in public and commercial spaces.**  
 Ideale per grandi pareti in spazi pubblici e commerciali.

Idéal pour des grands murs dans des espaces publics et commerciaux.

Ideal für große Wände in öffentlichen und gewerblichen Räumen.

Ideal para grandes paredes en espacios públicos y comerciales.

Идеально для стен общественных и коммерческих интерьеров.



**MARVELPRO DESIGN**

**White body wall tiles**

- Statuario Select 40x80 cm
- Noir St. Laurent 40x80 cm
- Noir St. Laurent Ribbon 40x80 cm

**Porcelain tiles**

- Statuario Select 60x60 cm Lappato
- Noir St. Laurent 60x60 cm Lappato
- Noir St. Laurent 45x90 cm Lappato
- Noir St. Laurent Listello 7x60 cm Lappato
- Noir St. Laurent Angolo 7x7 cm Lappato

**CORPORATE LOUNGE**



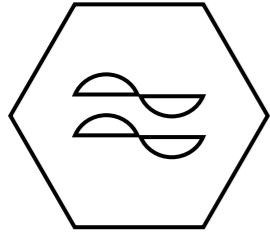

PRESIDENTIAL BATHROOM

# PRECIOUS LIGHT REFLECTIONS

RIFLESSI PREZIOSI

**Statuario Select has a pearl-like shade crossed by marked veining that enhances the spaces dedicated to hospitality. Where the luxury of marble blends with Italian style and functionality. The three-dimensional Ribbon finish adds a strong decorative element to the surface while the Noir St. Laurent mosaic characterizes and enriches showers and wellness areas.**

Statuario Select è una tonalità perlacea solcata da vigorose venature che valorizza spazi votati all'accoglienza, dove il lusso del marmo si sposa con lo stile italiano e le esigenze di praticità. La finitura tridimensionale Ribbon aggiunge intensa forza decorativa alla superficie, mentre il mosaico Noir St. Laurent definisce e impreziosisce docce e aree wellness.







**STATUARIO SELECT**  
WHITE-BODY WALL TILES



Statuario Select est une couleur nacrée sillonnée par de vigoureuses veines qui valorisent les espaces dédiés à l'accueil, où le luxe du marbre se mêle au style italien et aux besoins de praticité. La finition tridimensionnelle Ribbon transmet une intense puissance décorative à la surface, tandis que la mosaïque Noir St. Laurent définit et sublime les douches et les espaces bien-être.

*Statuario Select in perlmuttfarbener Tonalität, durchzogen von intensiven Äderungen, die die Gasträume betonen, in denen sich der Luxus von Marmor mit italienischem Stil und den Anforderungen der Zweckmäßigkeit verbinden. Die Dreidimensionalität von Ribbon fügt der Oberfläche eine intensive dekorative Kraft hinzu, während das Mosaik Noir St. Laurent reizvolle Dusch- und Wellness-Bereiche gestaltet.*

Statuario Select es una tonalidad nacarada surcada por energicas vetas que valoriza espacios dedicados a la recepción, en donde el lujo del mármol se une al estilo italiano respondiendo a la vez a las exigencias de practicidad. El acabado tridimensional Ribbon añade intensa fuerza decorativa a la superficie, mientras que el mosaico Noir St. Laurent define y enriquece duchas y áreas de bienestar.

*Жемчужный нюанс с глубокими прожилками Statuario Select благородно украшает пространства, в которых роскошь мрамора гармонично сочетается с итальянским стилем дизайна и высокой практичностью поверхности. Трехмерная фактура Ribbon увеличивает декоративный эффект покрытий, в то время как мозаика Noir St. Laurent придает душевым комнатам и велнес-пространствам ценную изысканность.*







**MARVELPRO WALL**  
Easy to cut and drill, easier to install  
accessories and decorations.

Facile da tagliare e forare, facilita  
l'istallazione di accessori e arredi.

Facile à couper et à percer,  
il facilite l'installation des  
accessoires et du mobilier.

Leicht zu schneiden und zu  
bohren, einfache Verlegung von  
Zubehör und Einrichtungen.

Fácil de cortar y perforar,  
facilita la instalación de  
accesorios y decoraciones.

Легкость резки и сверления  
отверстий, простота монтажа  
аксессуаров и предметов  
обстановки.



**STATUARIO SELECT**  
PORCELAIN TILES  
- HONED SURFACE -





**MARVELPRO RIBBON**  
A modern and spectacular three-dimensional finish for contemporary venues.

Una moderna e spettacolare finitura tridimensionale per scenografie contemporanee.

Une finition tridimensionnelle moderne et spectaculaire pour des scénographies contemporaines.

Eine moderne und spektakuläre dreidimensionale Oberfläche für moderne Inszenierungen.

Un moderno y espectacular acabado tridimensional para escenografías contemporáneas.

Эффектная трехмерная поверхность для создания актуального декора.



**STATUARIO SELECT RIBBON**  
WHITE-BODY WALL TILES





**MARVELPRO WALL**

**The glaze makes cleaning easier and guarantees the hygiene of the surfaces.**

Lo smalto semplifica la pulizia e assicura l'igiene delle superfici.

L'émail simplifie le nettoyage et assure l'hygiène des surfaces.

Die Glasur vereinfacht die Reinigung und sorgt für eine hygienische Oberfläche.

El esmalte simplifica la limpieza y asegura la higiene de las superficies.

Глазурь упрощает чистку и обеспечивает гигиеничность поверхностей.

**MARVELPRO DESIGN**

**PRESIDENTIAL BATHROOM**

**White body wall tiles**

- Statuario Select 40x80 cm
- Statuario Select Ribbon 40x80 cm
- Statuario Select Mosaic 30,5x30,5 cm
- Noir St. Laurent Mosaic 30,5x30,5 cm

**Porcelain tiles**

- Statuario Select 60x60 cm Lappato
- Noir St. Laurent Listello 7x60 cm Lappato
- Noir St. Laurent Angolo 7x7 cm Lappato

**Trim Tiles**

- Statuario Select Spigolo 0,85x30,5 cm
- Statuario Select Spigolo A.E. 0,85x0,85 cm
- Noir St. Laurent Spigolo 0,85x30,5 cm
- Noir St. Laurent Spigolo A.E. 0,85x0,85 cm





MARVEL<sup>PRO</sup>  
BUSINESS CITY

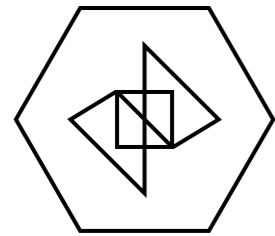

**BUSINESS DISTRICT**

Executive lounge

# VIBRANT STYLE

STILE VIBRANTE

**Marble-effect porcelain tiles in large formats are perfect for hospitality and business venues. Travertino Silver and Noir St. Laurent create a strong and refined contrast while the three-dimensional decors are energetic surfaces that emphasize the allure of the commercial project.**

Declinato nel grande formato, il gres porcellanato effetto marmo trova perfetta applicazione nei contesti dell'ospitalità e del business. Travertino Silver e Noir St. Laurent creano contrasti forti e raffinati, mentre i decori tridimensionali delineano superfici vibranti, accentuando l'atmosfera suggestiva dello spazio commerciale.

TRAVERTINOSILVER & NOIRSAINTLAURENT



White body wall tiles  
Noir St. Laurent Ribbon 40x80 cm |  
Porcelain tiles  
Travertino Silver 75x150 cm Lappato |  
Noir St. Laurent 75x150 cm Lappato |  
Travertino Silver Mosaico 3D 30x30 cm |

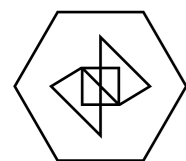

**BUSINESS DISTRICT**

Executive hall

Décliné dans le grand format, le grès cérame imitation marbre trouve une application parfaite dans les contextes de l'hospitalité et du business. Travertino Silver et Noir St. Laurent créent des contrastes intenses et raffinés, tandis que les décors tridimensionnels définissent des surfaces vibrantes, en accentuant l'atmosphère suggestive de l'espace commercial.

*Presentado en el gran formato, el grés porcelánico efecto mármol es perfecto para las aplicaciones en los contextos de hospitalidad y negocios. Travertino Silver y Noir St. Laurent crean contrastes marcados y refinados, mientras las decoraciones tridimensionales delinean superficies vibrantes, acentuando la atmósfera sugerente del espacio comercial.*

Auch im Großformat angeboten findet das Feinsteinzeug mit Marmor-Optik seine perfekte Anwendung in Kontexten der Hotellerie und im Gewerbe. Travertino Silver und Noir St. Laurent sorgen für raffinierte und starke Kontraste, während die dreidimensionalen Dekore vibrierende Oberflächen erzeugen, welche die eindrucksvolle Atmosphäre von Gewerberäumen hervorheben.

Крупноформатный керамогранит под мрамор великолепно вписывается в бизнес-интерьеры. Цвета Travertino Silver и Noir St. Laurent образуют эффектные контрасты, а трехмерные декоративные элементы придают поверхностям изумительный динамизм, подчеркивающий изысканную атмосферу пространства в целом.

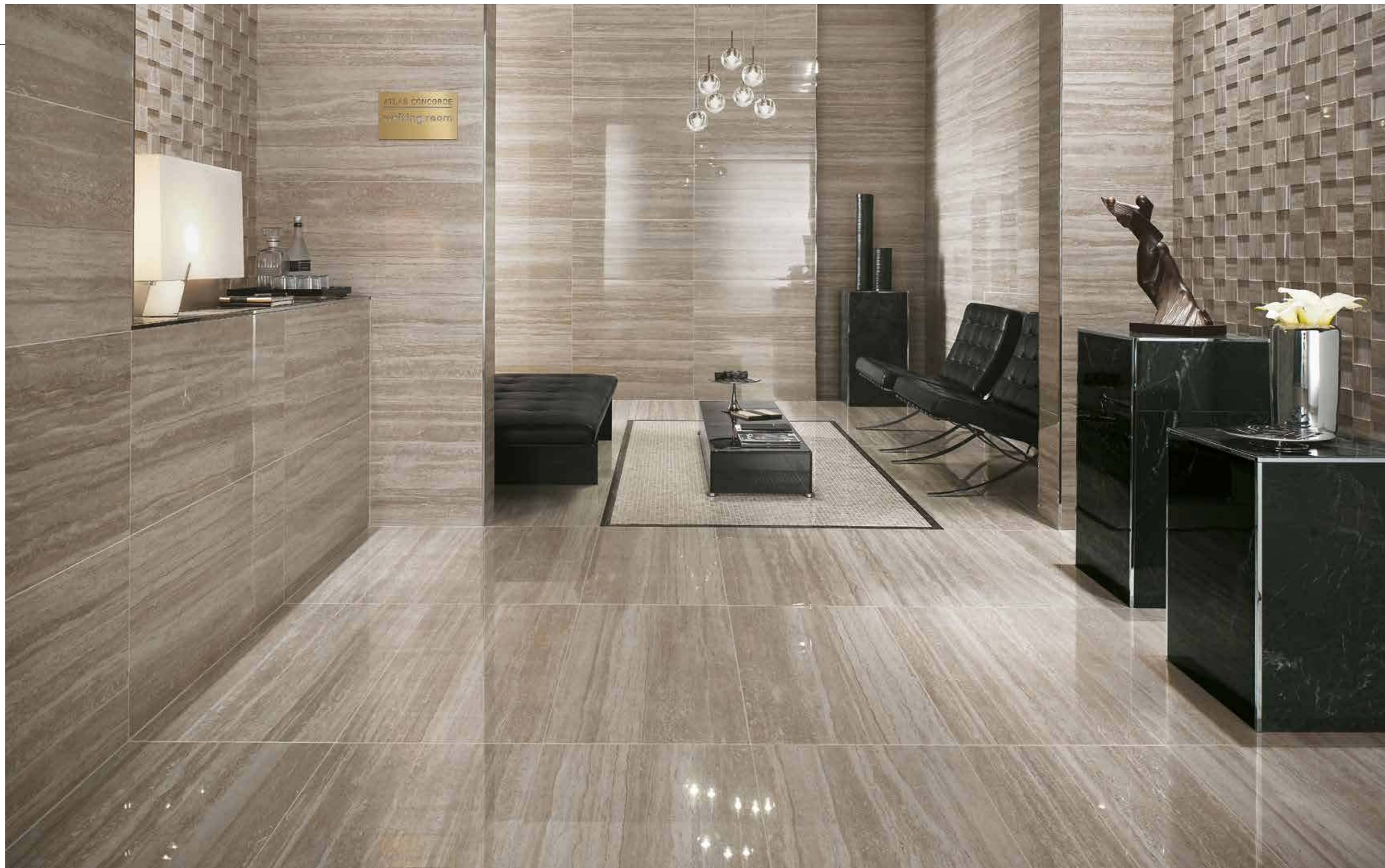





**MARVELPRO MOSAICO 3D**  
**Three-dimensional decors and honed mosaics exalt spaces and venues dedicated to business and hospitality.**  
Decorì tridimensionali e mosaici lappati definiscono spazi e aree dedicate al business e all'ospitalità.

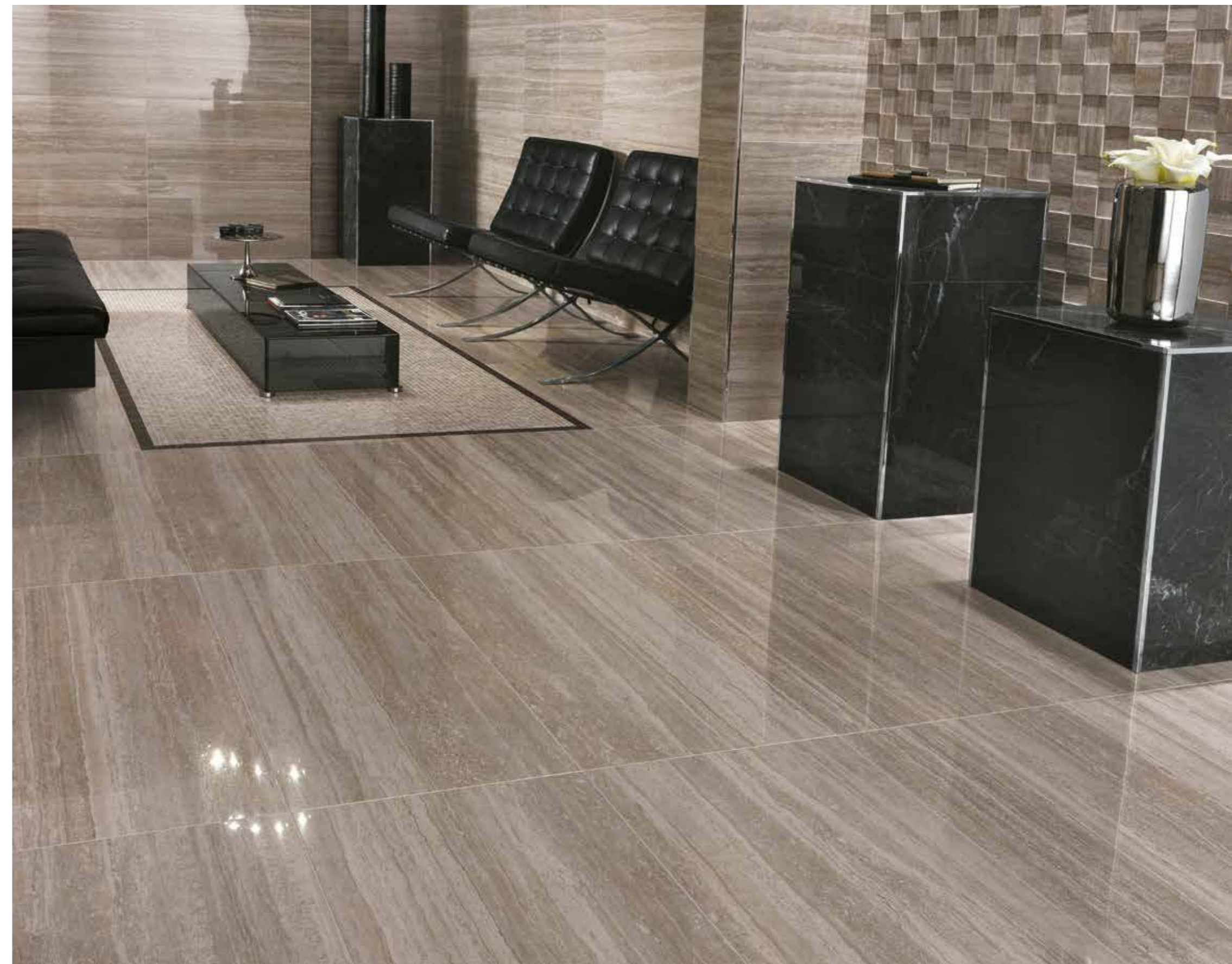

Des décors tridimensionnels et des mosaïques adoucies définissent les espaces et les zones dédiées au business et à l'hospitalité.

Dreidimensionale geläppte Dekore und Mosaik gestalten Gewerbeflächen und Räume der Gastlichkeit.

Decoraciones tridimensionales y mosaicos pulidos definen espacios y áreas dedicadas a los negocios y a la hospitalidad.

Трёхмерные декоры и лапатированная мозаика стильно украшают бизнес-пространства.





**TRAVERTINO SILVER**  
PORCELAIN TILES  
- HONED SURFACE -



**MARVEL<sup>PRO</sup> MOSAICO LAPPATO**  
Glossy honed inserts create mirror-like carpet motifs thanks to the countless facets.

Lucidissime tessere lappate definiscono specchianti tappeti grazie a infinite sfaccettature.

De très brillantes tesselles adoucies définissent des tapis réfléchissants grâce à une infinité de facettes.

Glänzende geläppte Steinchen bilden dank unzähliger Facetten spiegelnde Bordüren.

Brillantísimas teselas pulidas definen reflectantes alfombras gracias a infinitas facetas.

Блестящие лаппатированные элементы с бесчисленными бликами складываются в яркие ковры.







## MARVELPRO DESIGN

### Porcelain tiles

- Travertino Silver 45x90 cm Lappato
- Travertino Silver Mosaico 30x30 cm Lappato
- Noir St. Laurent Mosaico 30x30 cm Lappato
- Travertino Silver Mosaico 3D 30x30 cm Lappato
- Noir St. Laurent 45x90 cm Lappato

## BUSINESS DISTRICT

Executive hall

## MARVELPRO FLOOR DESIGN

PORCELAIN TILES

# MOSAICO 3D

**Matt and honed square macro-inserts on two levels create an elegant three-dimensional effect.**

Macro-tessere quadrate matt e lappate disposte su due livelli creano un elegante effetto tridimensionale.

Des macro-tesselles carrées mates et adoucies disposées sur deux niveaux créent un élégant effet tridimensionnel.

Matte und geläppte quadratische Makrosteine auf zwei Ebenen angeordnet erzeugen eine elegante dreidimensionale Wirkung.

Macro-teselas cuadradas opacas y pulidas dispuestas en dos niveles crean un elegante efecto tridimensional.

Большие квадратные элементы с матовой лаппатированной поверхностью образуют элегантный трехмерный эффект.

COLOURS <  
All colours available



Travertino Silver Mosaico 3D Lappato 30x30 cm



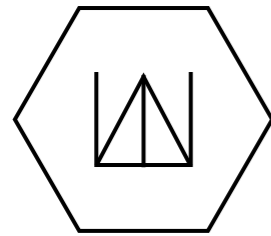

RESIDENTIAL BATHROOM

# INTENSE REFINEMENT

INTENSA RICERCATEZZA

The mirror-like glazing of Marvel PRO walls provides continuity with the extra glossy finish of the porcelain floor for a harmonious monochromatic effect. The bathroom walls in Travertino Silver create a space dedicated to relaxation exalted by elegant decors that enrich the beauty of natural marble effect.

L'aspetto specchiante dello smalto dei rivestimenti Marvel PRO richiama la lucidissima finitura lappata del pavimento in gres porcellanato per un armonioso effetto monocromatico. I rivestimenti bagno in Travertino Silver creano uno spazio relax valorizzato da eleganti decori che arricchiscono lo splendore del marmo di riferimento.





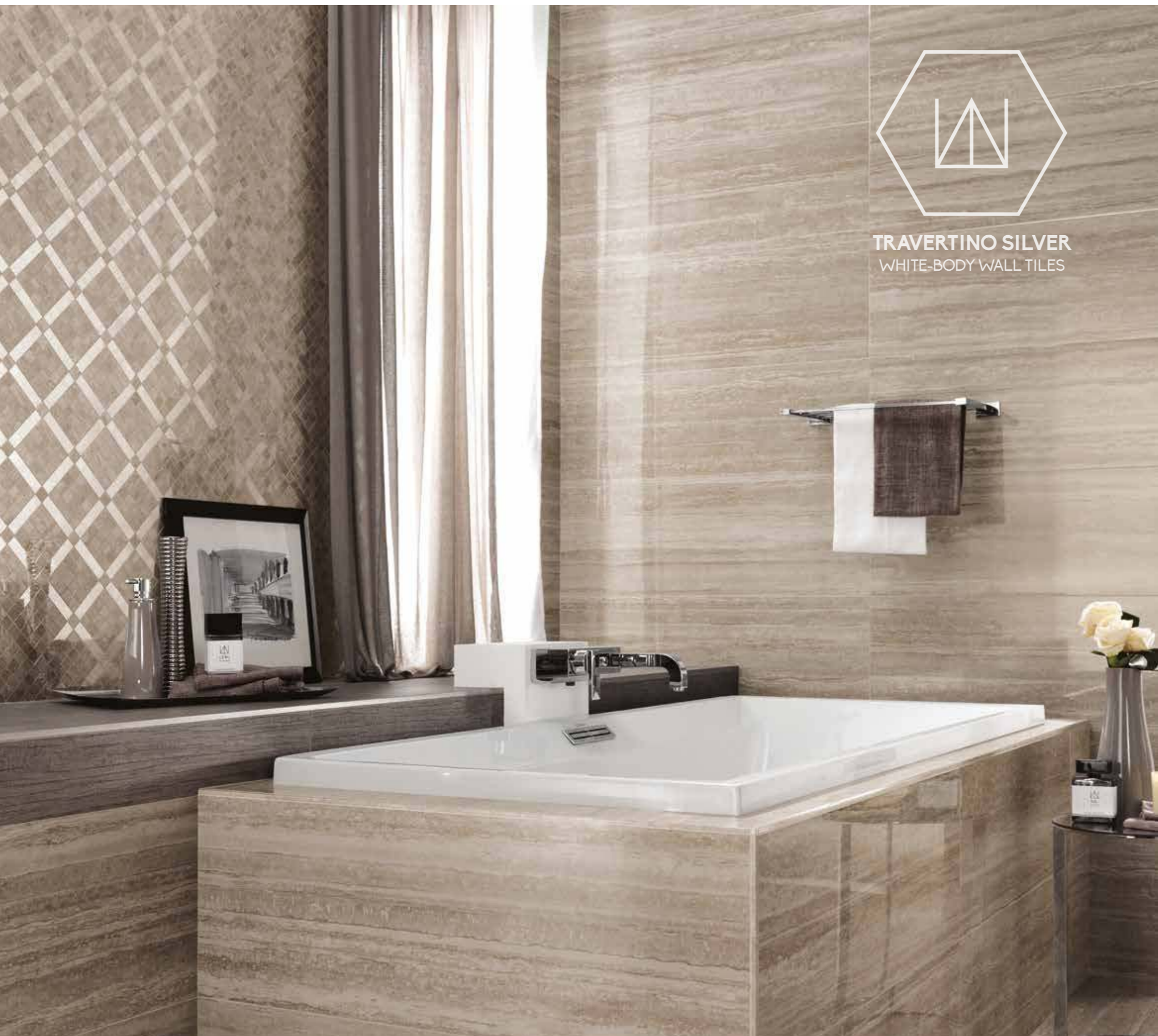

**TRAVERTINO SILVER**  
WHITE-BODY WALL TILES

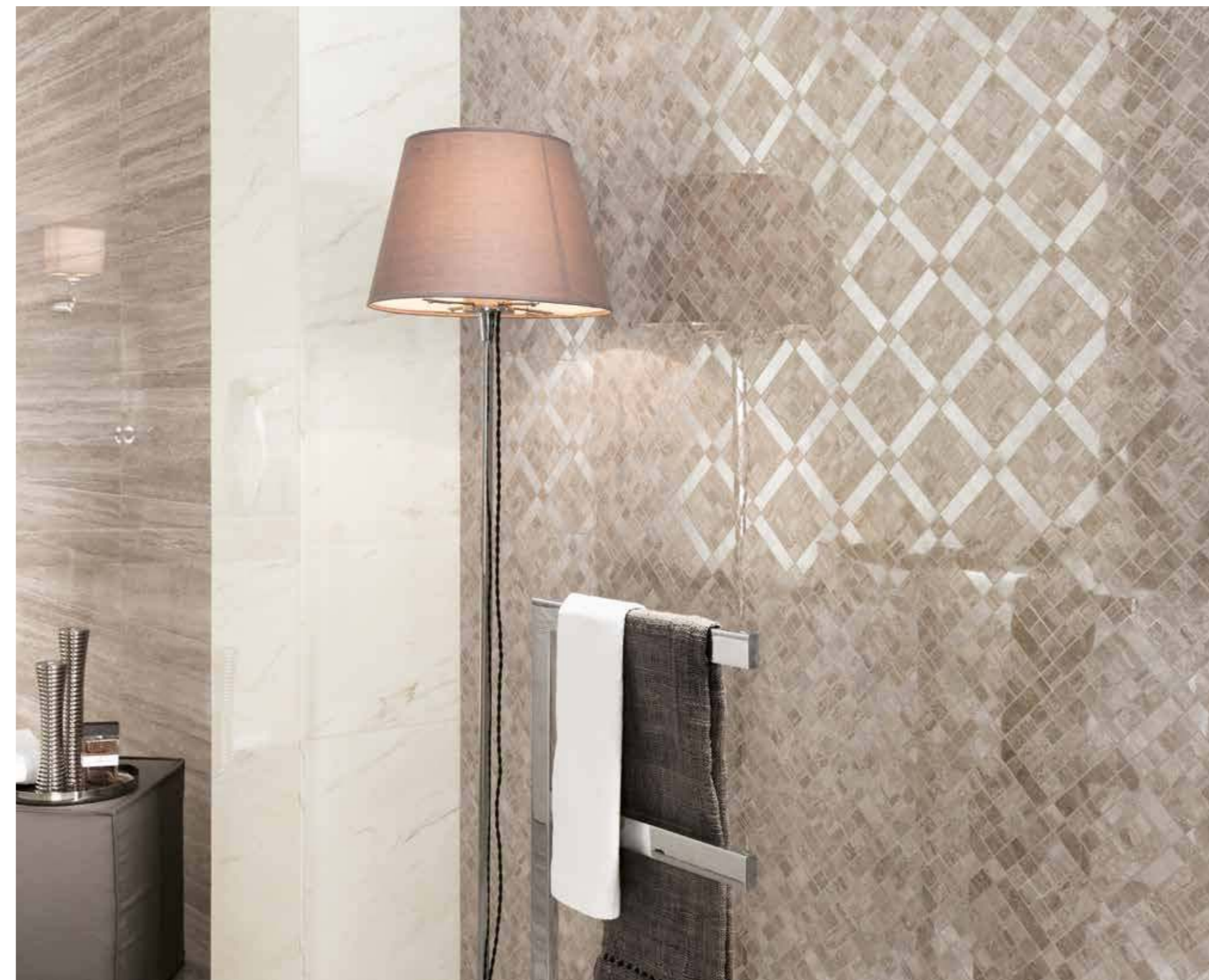

L'aspect réfléchissant de l'émail des revêtements Marvel PRO rappelle la finition adoucie très brillante du sol en grès cérame pour un effet monochromatique harmonieux. Les revêtements de salle de bain en Travertino Silver créent un espace de détente valorisé par d'élégants décors qui enrichissent la splendeur du marbre de référence.

*Die spiegelnde Wirkung der Glasur der Wände Marvel PRO erinnert an die glänzende, geläppte Oberfläche des Fußbodens in Feinsteinzeug und erzeugt eine harmonische einfarbige Wirkung. Die Badezimmerwandfliesen in Travertino Silver schaffen einen entspannenden Raum, der durch elegante Dekore und durch den Glanz der Marmorvorlage zur Geltung kommt.*

El aspecto reflectante del esmalte de los revestimientos Marvel PRO evoca el lucisísimo acabado pulido del pavimento en gres porcelánico brindando un armonioso efecto monocrómico. Los revestimientos de baño en Travertino Silver crean un espacio de relajación valorizado por elegantes decoraciones que enriquecen el esplendor del mármol de referencia.

*Зеркальная глазурь настенных плиток Marvel PRO оригинально сочетается с блестящей лапатированной поверхностью напольного керамогранита, рождая гармоничный монохромный эффект. Настенная плитка для ванной Travertino Silver с ее роскошной мраморной фактурой, обогащенной элегантными декорами, создает в интерьере расслабляющую обстановку.*

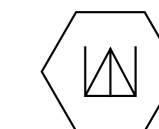



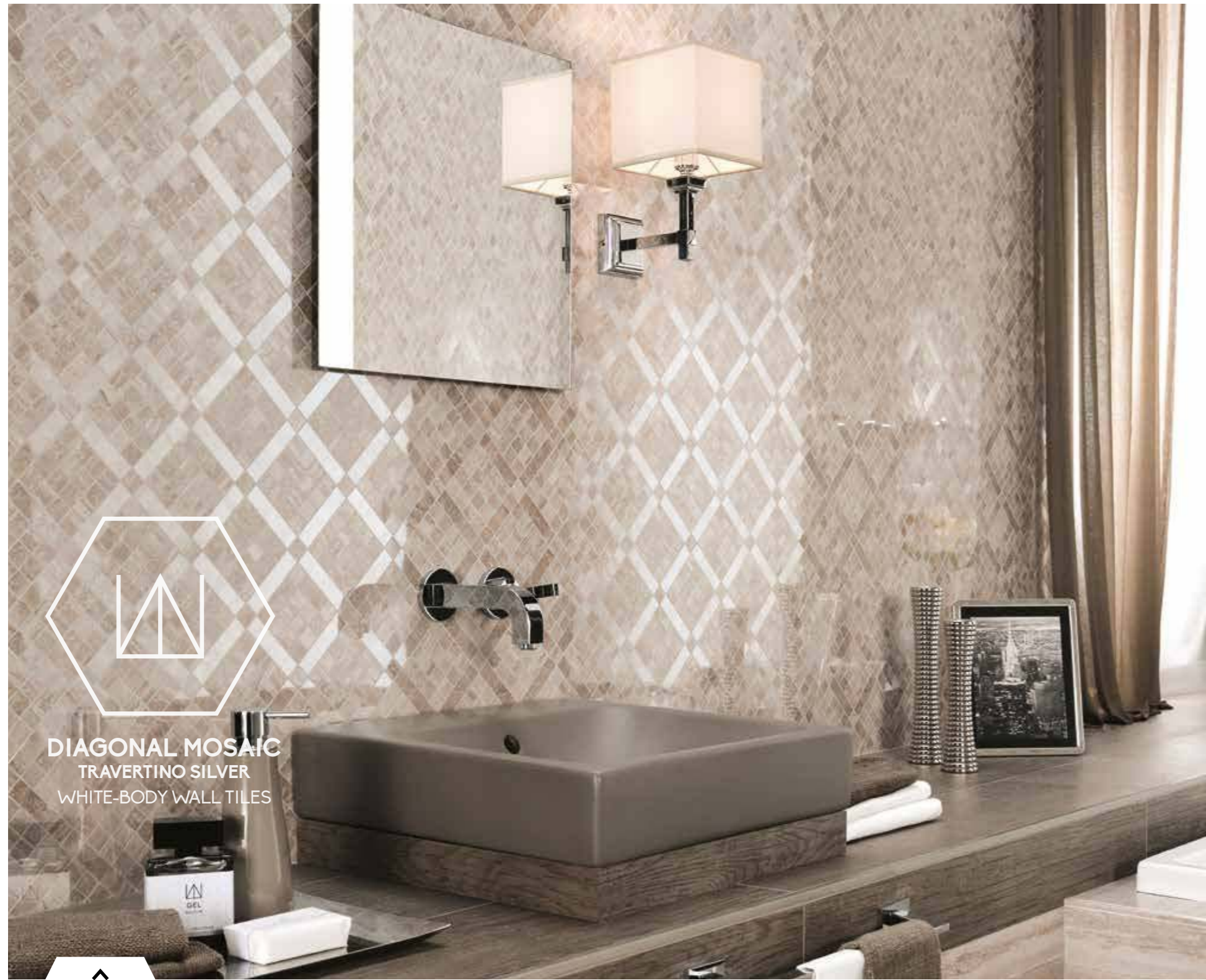

**DIAGONAL MOSAIC**  
TRAVERTINO SILVER  
WHITE-BODY WALL TILES

**MARVELPRO DIAGONAL MOSAIC**  
An intertwining of inserts creates a refined decorative effect in a single tint and in the elegant black & white contrast.

Un intreccio di tessere crea un raffinato effetto decorativo, in versione monocromatica o nell'elegante contrasto black&white.

Un entrelac de tesselles crée un effet décoratif raffiné, en version monochromatique ou dans un élégant contraste noir&blanc.

Durch den Mix von Steinchen entsteht ein anspruchsvoller dekorativer Effekt, einfarbig oder im stilvollen Schwarz-Weiß-Kontrast.

Una trama de teselas crea un refinado efecto decorativo, en versión monocromática o en el elegante contraste blanco y negro.

Маленькие кусочки мозаики могут складываться в изысканный однотонный декор и в элегантный черно-белый контраст.







**TRAVERTINO SILVER**  
PORCELAIN TILES  
- HONED SURFACE -

## MARVELPRO DESIGN

## RESIDENTIAL BATHROOM

### White body wall tiles

- Travertino Silver 30,5x91,5 cm
- Crema Delicato 30,5x91,5 cm
- Crema Delicato Mosaic 30,5x30,5 cm
- Travertino Silver Diagonal Mosaic 30,5x30,5 cm

### Porcelain tiles

- Travertino Silver 45x90 cm Lappato

### Trim Tiles

- Travertino Silver Spigolo 0,85x30,5 cm
- Travertino Silver Spigolo A.E. 0,85x0,85 cm
- Crema Delicato Spigolo 0,85x30,5 cm





MARVEL<sup>PRO</sup>  
LEISURE CITY

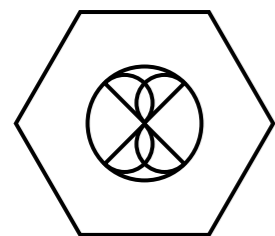

PRIVATE BATHROOM

## STUNNING INTIMACY

STUPENDA INTIMITÀ

**Marvel PRO walls faithfully reproduce the details and graphics of marble for a natural surface that is easy to clean and is both stain and chemical resistant. Travertino Alabastrino in size 30.5x91.5 with vertical installation alternated with partition walls decorated with Noir St. Laurent Brocade, creates elegant luxury venues.**

I rivestimenti Marvel PRO riproducono con cura i dettagli e la profondità grafica del marmo, per una superficie dall'estetica naturale, facile da pulire, resistente alle macchie e agli agenti chimici. Il Travertino Alabastrino in formato 30.5x91.5 posato in verticale e alternato a quinte decorate in Noir St. Laurent Brocade, crea spazi eleganti e lussuosi.

TRAVERTINOALABASTRINO & NOIRSAINTLAURENT







## TRAVERTINO ALABASTRINO

PORCELAIN TILES  
- HONED SURFACE -

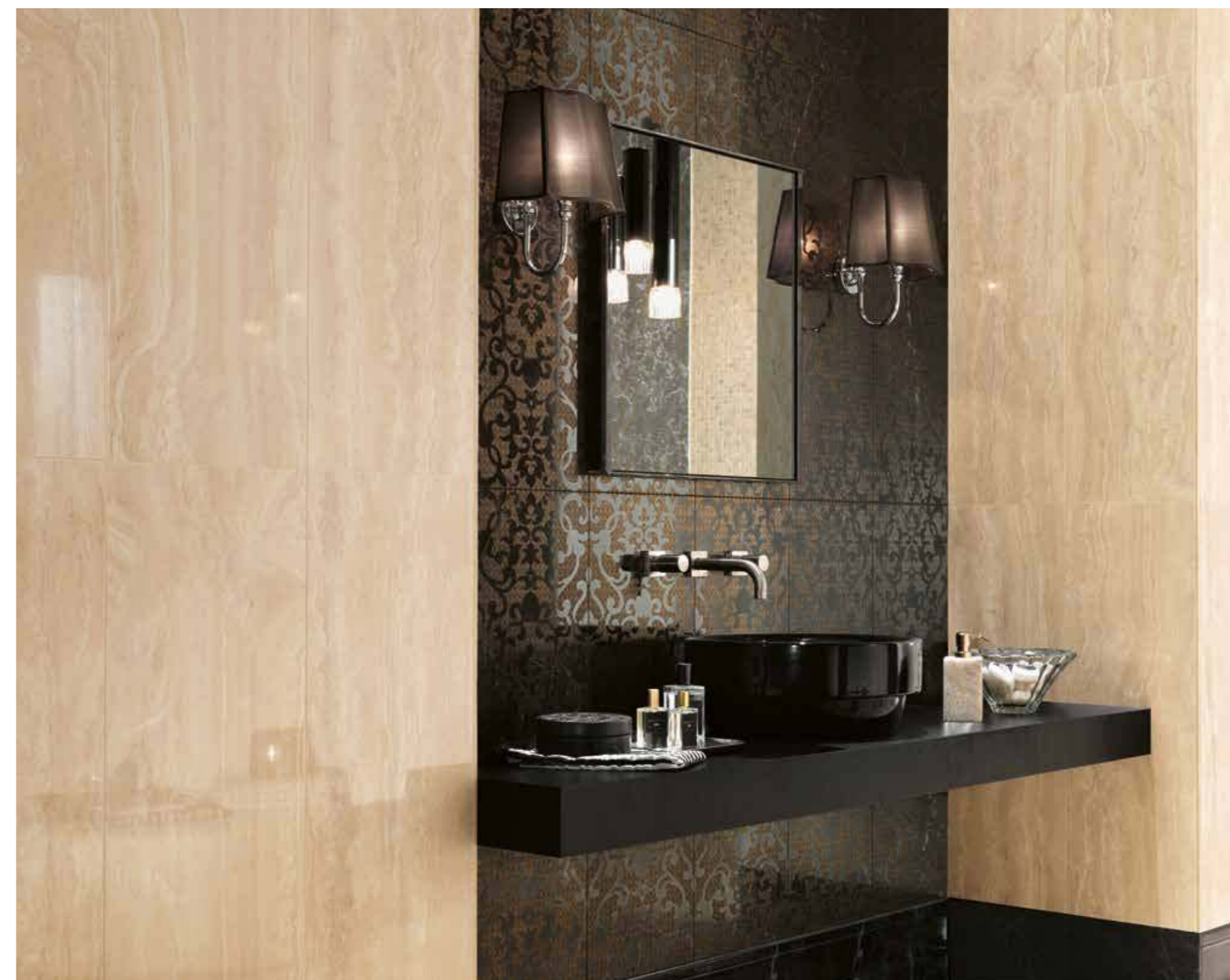

Les revêtements Marvel PRO reproduisent avec soin les détails et la profondeur graphique du marbre, pour une surface à l'esthétique naturelle, facile à nettoyer, résistante aux tâches et aux agents chimiques. Le Travertino Alabastrino au format 30.5x91.5 posé verticalement et alterné en coulisses décorées en Noir St. Laurent Brocade, crée des espaces élégants et luxueux.

*Die Wandbeläge Marvel PRO ahmen sorgfältig die Details und die graphische Tiefe des Marmors nach, für eine Oberfläche mit natürlicher Ästhetik, die leicht zu reinigen und resistent gegen Flecken und Chemikalien ist. Der Travertino Alabastrino, im Format 30.5x91.5 vertikal verlegt und abgewechselt mit dekorativen Wänden in Noir St. Laurent Brocade, schafft elegante und luxuriöse Räume.*

Los revestimientos Marvel PRO reproducen con precisión los detalles y la profundidad gráfica del mármol, para una superficie de estética natural, fácil de limpiar, resistente a las manchas y a los agentes químicos. El Travertino Alabastrino en formato 30.5x91.5 colocado en vertical y alternado con mamparas decoradas empleando Noir St. Laurent Brocade, crea espacios elegantes y lujosos.

*Настенная плитка Marvel PRO детально передает глубину рисунка мрамора на поверхности, которая выглядит предельно естественно, проста в уходе, стойка к образованию пятен и воздействию химических веществ. Уложенный вертикально Travertino Alabastrino формата 30.5x91.5, чередующийся с перегородками Noir St. Laurent Brocade, рождает роскошную и элегантную атмосферу.*

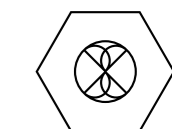



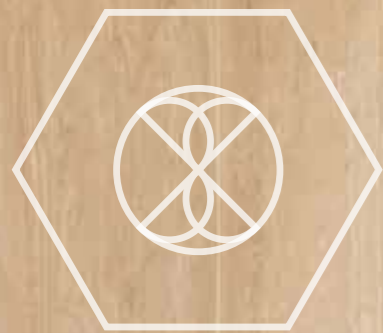

TRAVERTINO ALABASTRINO  
WHITE-BODY WALL TILES



**MARVEL<sup>PRO</sup> FLOOR&WALL**  
Perfect for bathrooms: resistant to stains from perfume, detergents, cosmetics and makeup.

Perfetto per l'ambiente bagno: resiste alle macchie di profumi, detersivi, cosmetici e make-up.

Parfait pour l'espace de bain : il résiste aux tâches de parfum, détergents, cosmétiques et maquillage.

Perfekt für Badezimmer: beständige gegenüber Duftstoffe, Reinigungsmittel, Kosmetik und Make-up.

Perfecto para el ambiente del baño: resiste a las manchas de perfumes, detergentes, cosméticos y make-up.

Идеально для ванных комнат: стойкость к образованию пятен от духи, детергентов, косметики.

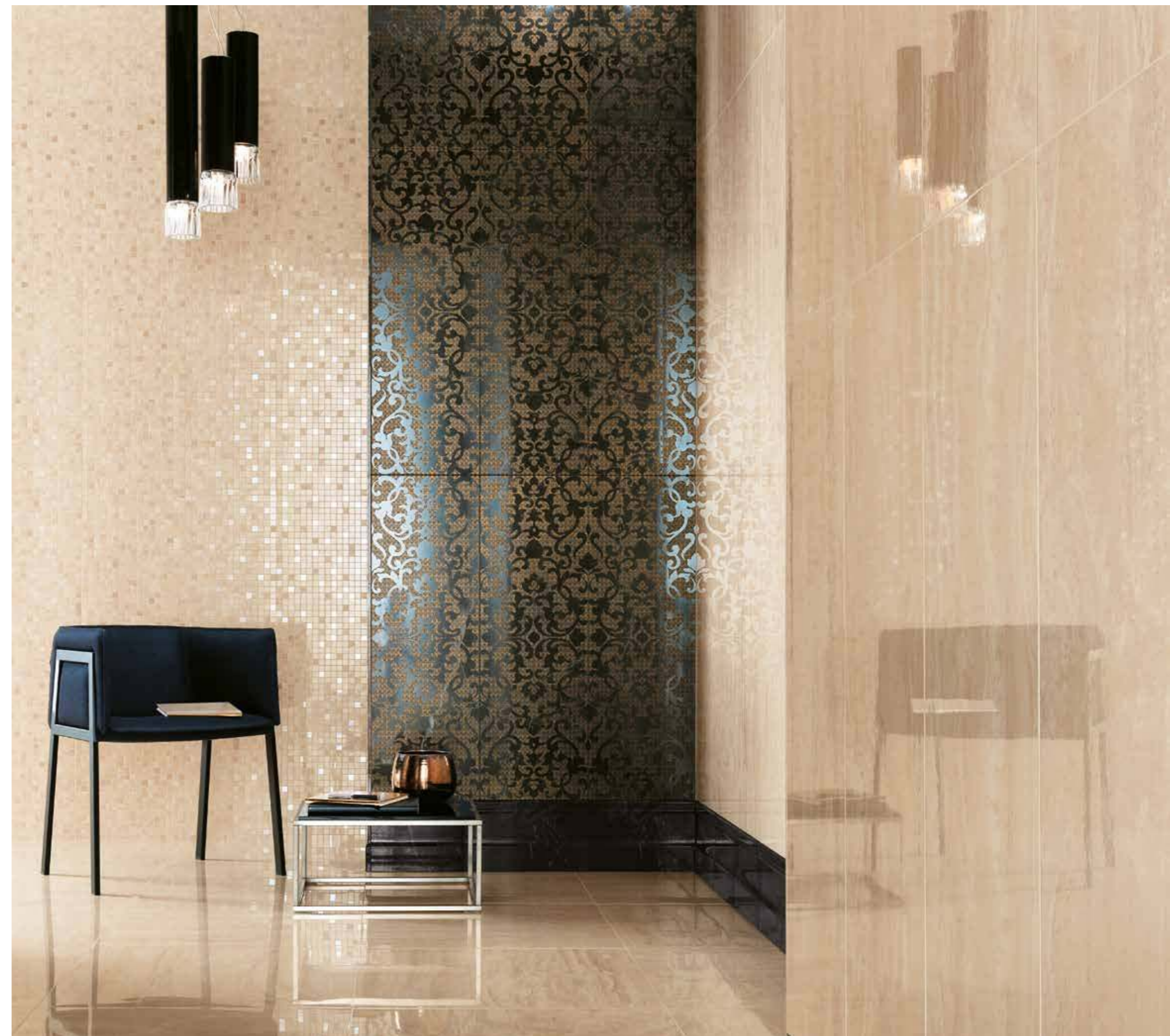



# BROCADE 31,5x91,5 cm

**The veining of marble merges with a refined brocade motif that changes the surface into a precious and spectacular partition.**  
 Le venature del marmo si intrecciano in un raffinato broccato, che trasforma la parete in una quinta preziosa e scenografica.

Les veines du marbre se mêlent dans un brocart raffiné, qui transforme les murs en une précieuse coulisse scénographique.  
 Die Äderungen des Marmors erinnern an feinen Brokat und machen die Wand zu einer wertvollen und eindrucksvollen großen Fläche.  
 Le vetas del mármol se trenzan en un refinado brocado, que transforma la pared en una mampara preciosa y escenográfica.  
 Прожилки мрамора сплетаются в утонченный парчовый узор, превращающий стену в драгоценный декор.

**COLOURS** <  
 Travertino Alabastrino, Noir St.Laurent



Noir St.Laurent Brocade 30,5x91,5 cm



## MARVELPRO DESIGN

### White body wall tiles

- Travertino Alabastrino 30,5x91,5 cm
- Noir St. Laurent Brocade 30,5x91,5 cm
- Travertino Alabastrino Mosaic 30,5x30,5 cm

### Porcelain tiles

- Travertino Alabastrino 60x60 cm Lappato

### Trim Tiles

- Noir St. Laurent Alzata 20x30,5 cm
- Noir St. Laurent Alzata A.E. 1,5x20 cm
- Noir St. Laurent Spigolo 0,85x30,5 cm
- Noir St. Laurent Spigolo A.E. 0,85x0,85 cm
- Noir St. Laurent London 5x30,5 cm
- Noir St. Laurent London A.E. 5x2,5 cm
- Travertino Alabastrino Spigolo 0,85x30,5 cm

## PRIVATE BATHROOM





# EXTRAORDINARY REALISM

STRAORDINARIO REALISMO

UN RÉALISME EXTRAORDINAIRE . AUßERGEWÖHNLICHER REALISMUS  
REALISMO EXTRAORDINARIO . ИЗУМИТЕЛЬНЫЙ РЕАЛИЗМ

## COLOUR-SHADING STONALIZZAZIONE



**V2**

Crema Delicato  
Travertino Silver  
Travertino Alabastrino  
Noir St.Laurent



**V3**

Statuario Select  
Grey Fleury



**V1**

Light  
Leggera  
Léger  
Leichte  
Ligera  
Лёгкое



**V2**

Moderate  
Moderata  
Moyen  
Mittlere  
Moderada  
Умеренное



**V3**

High  
Alta  
Haut  
Kräftigere  
Alta  
Высокое



**V4**

Random  
Random  
Casuel  
Zufällige  
Random  
Произвольное

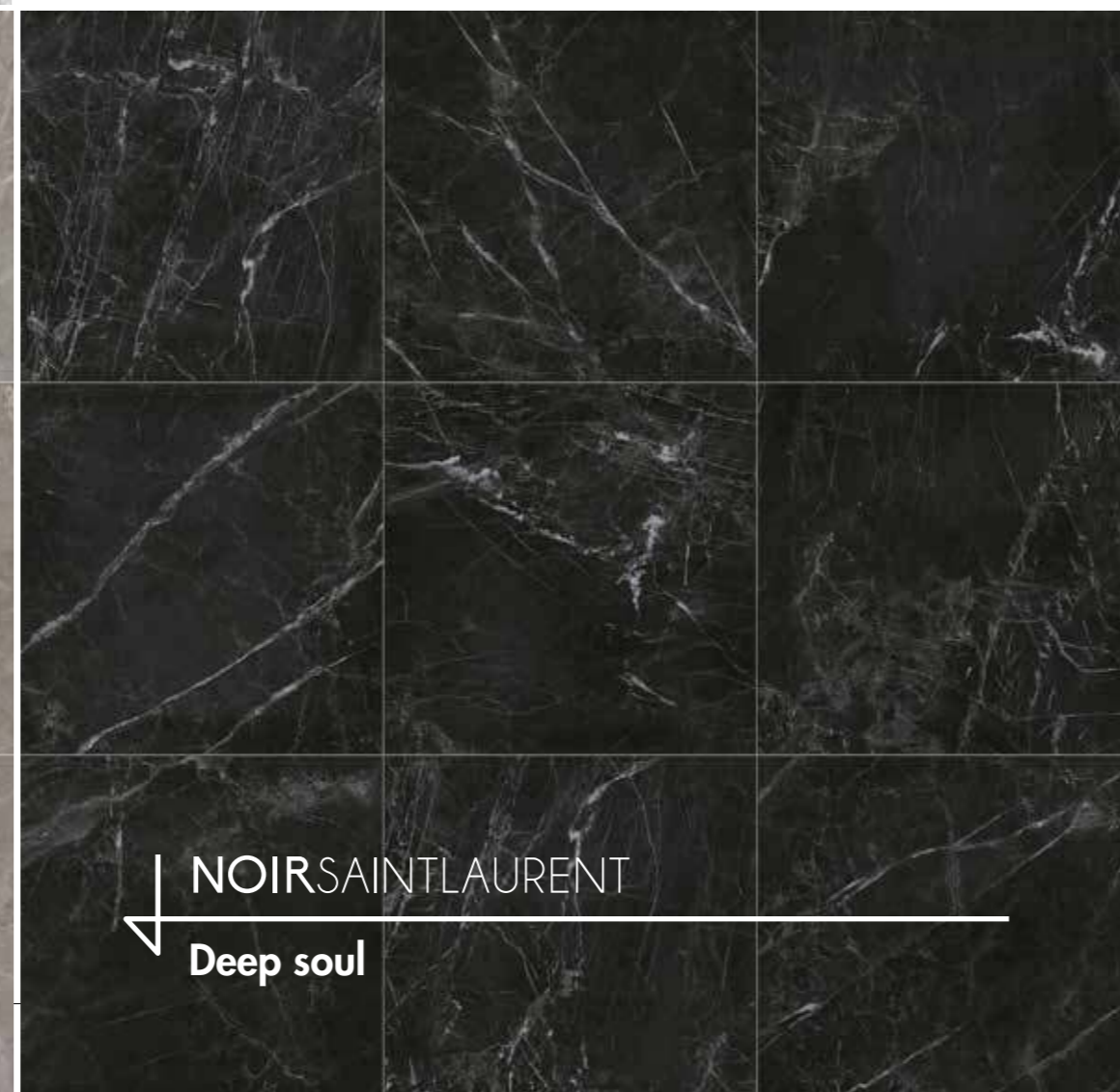
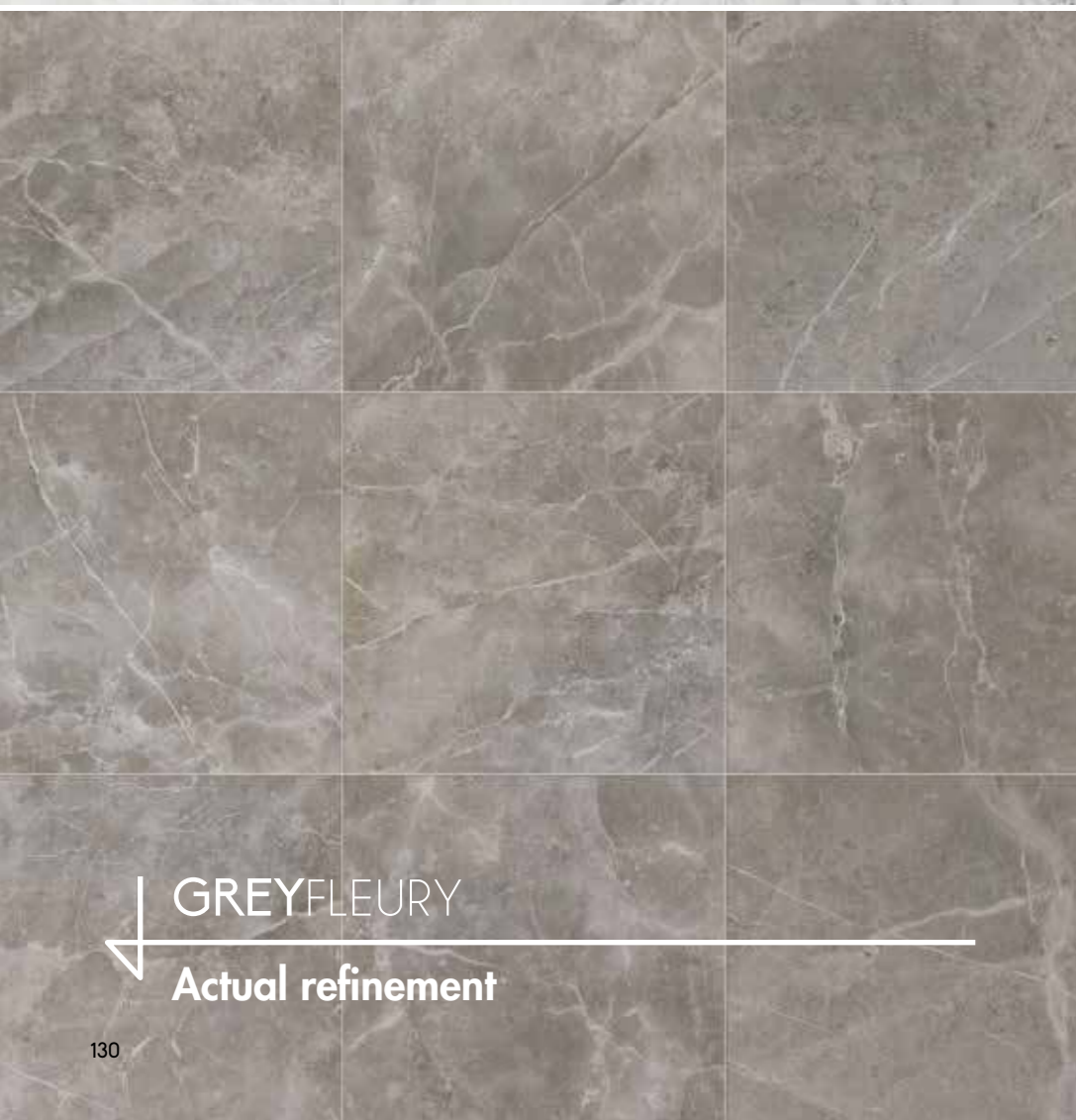

STATUARIOSELECT

Authentic splendour

TRAVERTINOSILVER

Timeless charm

GREYFLEURY

Actual refinement

NOIRSAINTLAURENT

Deep soul

CREMODELICATO

Delicate character

TRAVERTINOALABASTRINO

Contemporary elegance





Marvel Statuario Select 75x150 Lappato  
75x150 cm - 29½"x59"  
74x148 cm - 29⅛"x58¼"



Marvel Statuario Select 75x75 Lappato  
75x75 cm - 29½"x29½"  
74x74 cm - 29⅛"x29⅛"



Marvel Crema Delicata 75x150 Lappato  
75x150 cm - 29½"x59"  
74x148 cm - 29⅛"x58¼"



Marvel Crema Delicata 75x75 Lappato  
75x75 cm - 29½"x29½"  
74x74 cm - 29⅛"x29⅛"



Marvel Grey Fleury 75x150 Lappato  
75x150 cm - 29½"x59"  
74x148 cm - 29⅛"x58¼"



Marvel Grey Fleury 75x75 Lappato  
75x75 cm - 29½"x29½"  
74x74 cm - 29⅛"x29⅛"



Marvel Travertino Alabastrino 75x150 Lappato  
75x150 cm - 29½"x59"  
74x148 cm - 29⅛"x58¼"



Marvel Travertino Alabastrino 75x75 Lappato  
75x75 cm - 29½"x29½"  
74x74 cm - 29⅛"x29⅛"



Marvel Noir St.Laurent 75x150 Lappato  
75x150 cm - 29½"x59"  
74x148 cm - 29⅛"x58¼"



Marvel Noir St.Laurent 75x75 Lappato  
75x75 cm - 29½"x29½"  
74x74 cm - 29⅛"x29⅛"



Marvel Travertino Silver 75x150 Lappato  
75x150 cm - 29½"x59"  
74x148 cm - 29⅛"x58¼"



Marvel Travertino Silver 75x75 Lappato  
75x75 cm - 29½"x29½"  
74x74 cm - 29⅛"x29⅛"





Marvel Statuario Select 45x90 Lappato  
45x90 cm - 17<sup>3</sup>/<sub>8</sub>"x35<sup>3</sup>/<sub>8</sub>"  
44x88 - 17<sup>3</sup>/<sub>8</sub>"x34<sup>5</sup>/<sub>8</sub>"



Marvel Grey Fleury 45x90 Lappato  
45x90 cm - 17<sup>3</sup>/<sub>8</sub>"x35<sup>3</sup>/<sub>8</sub>"  
44x88 - 17<sup>3</sup>/<sub>8</sub>"x34<sup>5</sup>/<sub>8</sub>"



Marvel Noir St.Laurent 45x90 Lappato  
45x90 cm - 17<sup>3</sup>/<sub>8</sub>"x35<sup>3</sup>/<sub>8</sub>"  
44x88 - 17<sup>3</sup>/<sub>8</sub>"x34<sup>5</sup>/<sub>8</sub>"



Marvel Crema Delicata 45x90 Lappato  
45x90 cm - 17<sup>3</sup>/<sub>8</sub>"x35<sup>3</sup>/<sub>8</sub>"  
44x88 - 17<sup>3</sup>/<sub>8</sub>"x34<sup>5</sup>/<sub>8</sub>"



Marvel Travertino Alabastrino 45x90 Lappato  
45x90 cm - 17<sup>3</sup>/<sub>8</sub>"x35<sup>3</sup>/<sub>8</sub>"  
44x88 - 17<sup>3</sup>/<sub>8</sub>"x34<sup>5</sup>/<sub>8</sub>"



Marvel Travertino Silver 45x90 Lappato  
45x90 cm - 17<sup>3</sup>/<sub>8</sub>"x35<sup>3</sup>/<sub>8</sub>"  
44x88 - 17<sup>3</sup>/<sub>8</sub>"x34<sup>5</sup>/<sub>8</sub>"



Marvel Statuario Select 60x60 Lappato  
60x60 cm - 23<sup>5</sup>/<sub>8</sub>"x23<sup>5</sup>/<sub>8</sub>"  
59x59 - 23<sup>1</sup>/<sub>4</sub>"x23<sup>1</sup>/<sub>4</sub>"



Marvel Grey Fleury 60x60 Lappato  
60x60 cm - 23<sup>5</sup>/<sub>8</sub>"x23<sup>5</sup>/<sub>8</sub>"  
59x59 - 23<sup>1</sup>/<sub>4</sub>"x23<sup>1</sup>/<sub>4</sub>"



Marvel Noir St.Laurent 60x60 Lappato  
60x60 cm - 23<sup>5</sup>/<sub>8</sub>"x23<sup>5</sup>/<sub>8</sub>"  
59x59 - 23<sup>1</sup>/<sub>4</sub>"x23<sup>1</sup>/<sub>4</sub>"



Marvel Crema Delicata 60x60 Lappato  
60x60 cm - 23<sup>5</sup>/<sub>8</sub>"x23<sup>5</sup>/<sub>8</sub>"  
59x59 - 23<sup>1</sup>/<sub>4</sub>"x23<sup>1</sup>/<sub>4</sub>"



Marvel Travertino Alabastrino 60x60 Lappato  
60x60 cm - 23<sup>5</sup>/<sub>8</sub>"x23<sup>5</sup>/<sub>8</sub>"  
59x59 - 23<sup>1</sup>/<sub>4</sub>"x23<sup>1</sup>/<sub>4</sub>"



Marvel Travertino Silver 60x60 Lappato  
60x60 cm - 23<sup>5</sup>/<sub>8</sub>"x23<sup>5</sup>/<sub>8</sub>"  
59x59 - 23<sup>1</sup>/<sub>4</sub>"x23<sup>1</sup>/<sub>4</sub>"

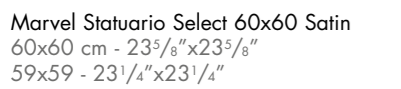

Marvel Statuario Select 60x60 Satin  
60x60 cm - 23<sup>5</sup>/<sub>8</sub>"x23<sup>5</sup>/<sub>8</sub>"  
59x59 - 23<sup>1</sup>/<sub>4</sub>"x23<sup>1</sup>/<sub>4</sub>"

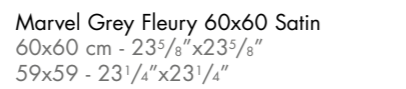

Marvel Grey Fleury 60x60 Satin  
60x60 cm - 23<sup>5</sup>/<sub>8</sub>"x23<sup>5</sup>/<sub>8</sub>"  
59x59 - 23<sup>1</sup>/<sub>4</sub>"x23<sup>1</sup>/<sub>4</sub>"

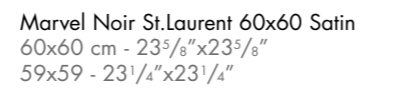

Marvel Noir St.Laurent 60x60 Satin  
60x60 cm - 23<sup>5</sup>/<sub>8</sub>"x23<sup>5</sup>/<sub>8</sub>"  
59x59 - 23<sup>1</sup>/<sub>4</sub>"x23<sup>1</sup>/<sub>4</sub>"

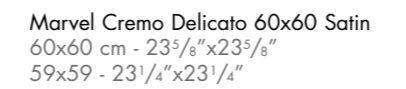

Marvel Crema Delicata 60x60 Satin  
60x60 cm - 23<sup>5</sup>/<sub>8</sub>"x23<sup>5</sup>/<sub>8</sub>"  
59x59 - 23<sup>1</sup>/<sub>4</sub>"x23<sup>1</sup>/<sub>4</sub>"

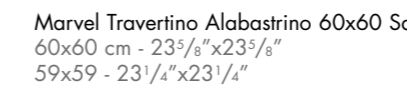

Marvel Travertino Alabastrino 60x60 Satin  
60x60 cm - 23<sup>5</sup>/<sub>8</sub>"x23<sup>5</sup>/<sub>8</sub>"  
59x59 - 23<sup>1</sup>/<sub>4</sub>"x23<sup>1</sup>/<sub>4</sub>"

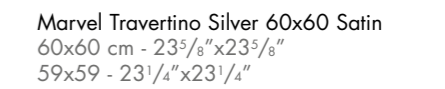

Marvel Travertino Silver 60x60 Satin  
60x60 cm - 23<sup>5</sup>/<sub>8</sub>"x23<sup>5</sup>/<sub>8</sub>"  
59x59 - 23<sup>1</sup>/<sub>4</sub>"x23<sup>1</sup>/<sub>4</sub>"



Marvel Statuario Select 30x60 Lappato  
30x60 cm - 11<sup>3</sup>/<sub>4</sub>"x23<sup>5</sup>/<sub>8</sub>"  
29,5x59 - 11<sup>5</sup>/<sub>8</sub>"x23<sup>1</sup>/<sub>4</sub>"



Marvel Grey Fleury 30x60 Lappato  
30x60 cm - 11<sup>3</sup>/<sub>4</sub>"x23<sup>5</sup>/<sub>8</sub>"  
29,5x59 - 11<sup>5</sup>/<sub>8</sub>"x23<sup>1</sup>/<sub>4</sub>"



Marvel Noir St.Laurent 30x60 Lappato  
30x60 cm - 11<sup>3</sup>/<sub>4</sub>"x23<sup>5</sup>/<sub>8</sub>"  
29,5x59 - 11<sup>5</sup>/<sub>8</sub>"x23<sup>1</sup>/<sub>4</sub>"



Marvel Crema Delicata 30x60 Lappato  
30x60 cm - 11<sup>3</sup>/<sub>4</sub>"x23<sup>5</sup>/<sub>8</sub>"  
29,5x59 - 11<sup>5</sup>/<sub>8</sub>"x23<sup>1</sup>/<sub>4</sub>"



Marvel Travertino Alabastrino 30x60 Lappato  
30x60 cm - 11<sup>3</sup>/<sub>4</sub>"x23<sup>5</sup>/<sub>8</sub>"  
29,5x59 - 11<sup>5</sup>/<sub>8</sub>"x23<sup>1</sup>/<sub>4</sub>"



Marvel Travertino Silver 30x60 Lappato  
30x60 cm - 11<sup>3</sup>/<sub>4</sub>"x23<sup>5</sup>/<sub>8</sub>"  
29,5x59 - 11<sup>5</sup>/<sub>8</sub>"x23<sup>1</sup>/<sub>4</sub>"

DESTINATIONS OF USE / DESTINAZIONI D'USO



MEDIUM TRAFFIC  
CALPESTIO MEDIO

MODERATE COMMERCIAL AREAS (restaurants, offices, showrooms, public restrooms, public offices, hotels, business lounges, etc. save for obligated pathways)  
COMMERCIALI MEDI (ristoranti, uffici, negozi, bagni pubblici, uffici pubblici, hotel, business lounge, etc. a esclusione di passaggi obbligati)



MACCHIA APERTA



Marvel Statuario Select Macchia Aperta Lappato A ♦  
75x150 cm - 29 1/2"x59"



Marvel Statuario Select Macchia Aperta Lappato B ♦  
75x150 cm - 29 1/2"x59"



Marvel Grey Fleury Macchia Aperta Lappato A ♦  
75x150 cm - 29 1/2"x59"



Marvel Grey Fleury Macchia Aperta Lappato B ♦  
75x150 cm - 29 1/2"x59"

LAYOUT

In order to obtain a symmetrical open book installation pattern as reported in the charts below, it is necessary to lay an equal number of tiles of type A and B / Per ottenere la posa simmetrica a macchia aperta riportata negli schemi di posa sottostanti occorre posare un numero uguale di piastrelle di tipo A e di tipo B / Pour obtenir la pose symétrique à livre ouvert indiquée dans les schémas de pose ci-dessous, il est nécessaire de poser une quantité identique de carreaux de type A et de type B / Für die symmetrische bildfurnierte Verlegung, wie im Verlegeschema dargestellt, muss man die gleiche Anzahl von Fliesen vom Typ A und Typ B verlegen / Para obtener la colocación a libro abierto mostrada en los esquemas de colocación de abajo hay que colocar el mismo número de baldosas de tipo A y de tipo B / Для получения симметричного зеркального рисунка укладки, приведенного на схемах ниже, необходимо уложить одинаковое число плиток типа А и типа В

♦ Not matching with sizes 74x148 cm, 74x74 cm / Non abbinabile ai formati 74x148 cm, 74x74 cm  
Ne peut être assorti aux formats 74x148 cm, 74x74 cm / Nicht mit den Formaten 74x148 cm, 74x74 cm kombinierbar  
No combinable con los formatos 74x148 cm, 74x74 cm / Не сочет ется с форм т ми 74x148 см, 74x74 см



Layout 1



Layout 2



Layout 3



Layout 4



Layout 1



Layout 2



Layout 3

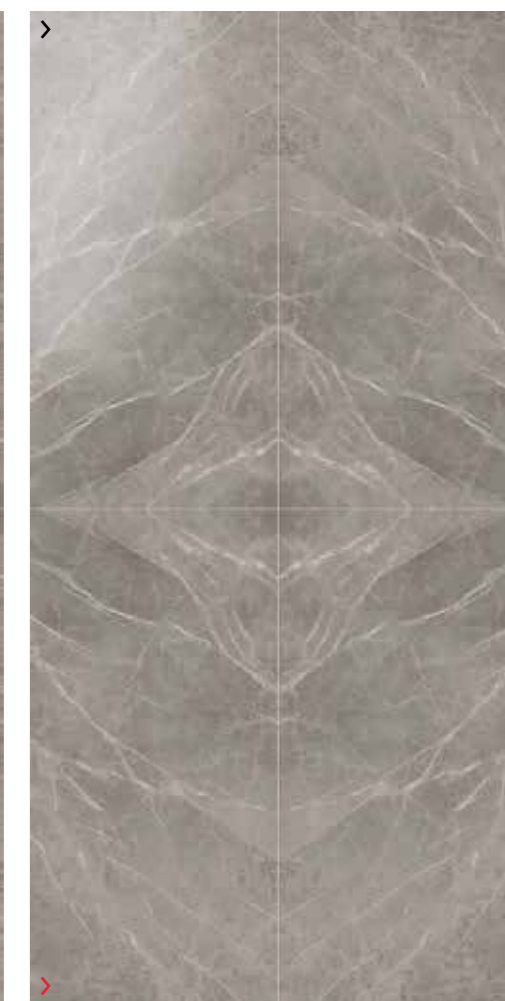

Layout 4





Marvel Statuario Select 45x90 Matt  
45x90 cm - 17<sup>3</sup>/<sub>4</sub>"x35<sup>3</sup>/<sub>8</sub>"



Marvel Grey Fleury 45x90 Matt  
45x90 cm - 17<sup>3</sup>/<sub>4</sub>"x35<sup>3</sup>/<sub>8</sub>"



Marvel Noir St.Laurent 45x90 Matt  
45x90 cm - 17<sup>3</sup>/<sub>4</sub>"x35<sup>3</sup>/<sub>8</sub>"



Marvel Crema Delicata 45x90 Matt  
45x90 cm - 17<sup>3</sup>/<sub>4</sub>"x35<sup>3</sup>/<sub>8</sub>"



Marvel Travertino Alabastrino 45x90 Matt  
45x90 cm - 17<sup>3</sup>/<sub>4</sub>"x35<sup>3</sup>/<sub>8</sub>"



Marvel Travertino Silver 45x90 Matt  
45x90 cm - 17<sup>3</sup>/<sub>4</sub>"x35<sup>3</sup>/<sub>8</sub>"



Marvel Statuario Select 60x60 Matt  
60x60 cm - 23<sup>5</sup>/<sub>8</sub>"x23<sup>5</sup>/<sub>8</sub>"



Marvel Grey Fleury 60x60 Matt  
60x60 cm - 23<sup>5</sup>/<sub>8</sub>"x23<sup>5</sup>/<sub>8</sub>"



Marvel Noir St.Laurent 60x60 Matt  
60x60 cm - 23<sup>5</sup>/<sub>8</sub>"x23<sup>5</sup>/<sub>8</sub>"

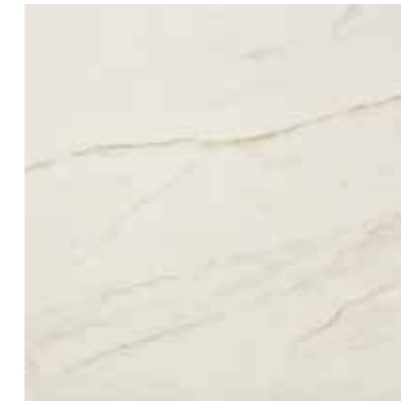

Marvel Crema Delicata 60x60 Matt  
60x60 cm - 23<sup>5</sup>/<sub>8</sub>"x23<sup>5</sup>/<sub>8</sub>"



Marvel Travertino Alabastrino 60x60 Matt  
60x60 cm - 23<sup>5</sup>/<sub>8</sub>"x23<sup>5</sup>/<sub>8</sub>"



Marvel Travertino Silver 60x60 Matt  
60x60 cm - 23<sup>5</sup>/<sub>8</sub>"x23<sup>5</sup>/<sub>8</sub>"



Marvel Statuario Select 30x60 Matt  
30x60 cm - 11<sup>3</sup>/<sub>4</sub>"x23<sup>5</sup>/<sub>8</sub>"



Marvel Grey Fleury 30x60 Matt  
30x60 cm - 11<sup>3</sup>/<sub>4</sub>"x23<sup>5</sup>/<sub>8</sub>"



Marvel Noir St.Laurent 30x60 Matt  
30x60 cm - 11<sup>3</sup>/<sub>4</sub>"x23<sup>5</sup>/<sub>8</sub>"



Marvel Crema Delicata 30x60 Matt  
30x60 cm - 11<sup>3</sup>/<sub>4</sub>"x23<sup>5</sup>/<sub>8</sub>"



Marvel Travertino Alabastrino 30x60 Matt  
30x60 cm - 11<sup>3</sup>/<sub>4</sub>"x23<sup>5</sup>/<sub>8</sub>"



Marvel Travertino Silver 30x60 Matt  
30x60 cm - 11<sup>3</sup>/<sub>4</sub>"x23<sup>5</sup>/<sub>8</sub>"

**DESTINATIONS OF USE / DESTINAZIONI D'USO**



**MEDIUM TRAFFIC**  
CALPESTIO MEDIO

MODERATE COMMERCIAL AREAS (restaurants, offices, showrooms, public restrooms, public offices, hotels, business lounges, etc. save for obligated pathways)  
COMMERCIALI MEDI (ristoranti, uffici, negozi, bagni pubblici, uffici pubblici, hotel, business lounge, etc. a esclusione di passaggi obbligati)





Marvel Statuario Select 30x60 Strutturato  
30x60 cm - 11<sup>3</sup>/<sub>4</sub>"x23<sup>5</sup>/<sub>8</sub>"



Marvel Grey Fleury 30x60 Strutturato  
30x60 cm - 11<sup>3</sup>/<sub>4</sub>"x23<sup>5</sup>/<sub>8</sub>"



Marvel Crema Delicata 30x60 Strutturato  
30x60 cm - 11<sup>3</sup>/<sub>4</sub>"x23<sup>5</sup>/<sub>8</sub>"

**LASTRA 20mm**



Marvel Statuario Select 60x60 LASTRA 20mm  
60x60 cm - 23<sup>5</sup>/<sub>8</sub>"x23<sup>5</sup>/<sub>8</sub>"



Marvel Grey Fleury 60x60 LASTRA 20mm  
60x60 cm - 23<sup>5</sup>/<sub>8</sub>"x23<sup>5</sup>/<sub>8</sub>"



Marvel Crema Delicata 60x60 LASTRA 20mm  
60x60 cm - 23<sup>5</sup>/<sub>8</sub>"x23<sup>5</sup>/<sub>8</sub>"



Marvel Statuario Select 45x90 LASTRA 20mm  
45x90 cm - 17<sup>3</sup>/<sub>4</sub>"x35<sup>3</sup>/<sub>8</sub>"



Marvel Grey Fleury 45x90 LASTRA 20mm  
45x90 cm - 17<sup>3</sup>/<sub>4</sub>"x35<sup>3</sup>/<sub>8</sub>"



Marvel Crema Delicata 45x90 LASTRA 20mm  
45x90 cm - 17<sup>3</sup>/<sub>4</sub>"x35<sup>3</sup>/<sub>8</sub>"

MOSAICS / MOSAICI



Marvel Statuario Select Mosaico 3D  
30x30 cm - 11<sup>3</sup>/<sub>4</sub>"x11<sup>3</sup>/<sub>4</sub>"



Marvel Grey Fleury Mosaico 3D  
30x30 cm - 11<sup>3</sup>/<sub>4</sub>"x11<sup>3</sup>/<sub>4</sub>"

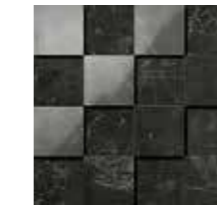

Marvel Noir St.Laurent Mosaico 3D  
30x30 cm - 11<sup>3</sup>/<sub>4</sub>"x11<sup>3</sup>/<sub>4</sub>"



Marvel Crema Delicata Mosaico 3D  
30x30 cm - 11<sup>3</sup>/<sub>4</sub>"x11<sup>3</sup>/<sub>4</sub>"



Marvel Travertino Alabastrino Mosaico 3D  
30x30 cm - 11<sup>3</sup>/<sub>4</sub>"x11<sup>3</sup>/<sub>4</sub>"



Marvel Travertino Silver Mosaico 3D  
30x30 cm - 11<sup>3</sup>/<sub>4</sub>"x11<sup>3</sup>/<sub>4</sub>"



Marvel Statuario Select Mosaico Lappato  
30x30 cm - 11<sup>3</sup>/<sub>4</sub>"x11<sup>3</sup>/<sub>4</sub>"

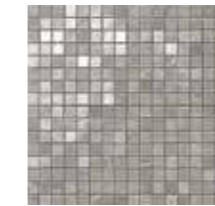

Marvel Grey Fleury Mosaico Lappato  
30x30 cm - 11<sup>3</sup>/<sub>4</sub>"x11<sup>3</sup>/<sub>4</sub>"

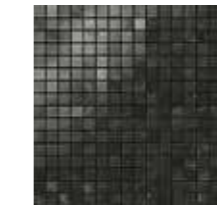

Marvel Noir St.Laurent Mosaico Lappato  
30x30 cm - 11<sup>3</sup>/<sub>4</sub>"x11<sup>3</sup>/<sub>4</sub>"

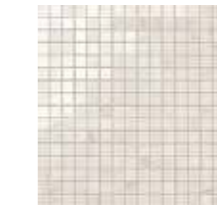

Marvel Crema Delicata Mosaico Lappato  
30x30 cm - 11<sup>3</sup>/<sub>4</sub>"x11<sup>3</sup>/<sub>4</sub>"



Marvel Travertino Alabastrino Mosaico Lappato  
30x30 cm - 11<sup>3</sup>/<sub>4</sub>"x11<sup>3</sup>/<sub>4</sub>"

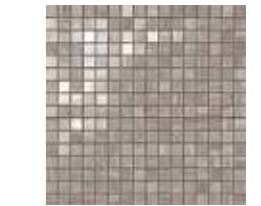

Marvel Travertino Silver Mosaico Lappato  
30x30 cm - 11<sup>3</sup>/<sub>4</sub>"x11<sup>3</sup>/<sub>4</sub>"



Marvel Statuario Select Mosaico Matt  
30x30 cm - 11<sup>3</sup>/<sub>4</sub>"x11<sup>3</sup>/<sub>4</sub>"

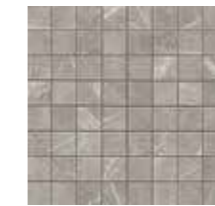

Marvel Grey Fleury Mosaico Matt  
30x30 cm - 11<sup>3</sup>/<sub>4</sub>"x11<sup>3</sup>/<sub>4</sub>"

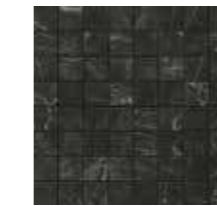

Marvel Noir St.Laurent Mosaico Matt  
30x30 cm - 11<sup>3</sup>/<sub>4</sub>"x11<sup>3</sup>/<sub>4</sub>"



Marvel Crema Delicata Mosaico Matt  
30x30 cm - 11<sup>3</sup>/<sub>4</sub>"x11<sup>3</sup>/<sub>4</sub>"



Marvel Travertino Alabastrino Mosaico Matt  
30x30 cm - 11<sup>3</sup>/<sub>4</sub>"x11<sup>3</sup>/<sub>4</sub>"



Marvel Travertino Silver Mosaico Matt  
30x30 cm - 11<sup>3</sup>/<sub>4</sub>"x11<sup>3</sup>/<sub>4</sub>"



Marvel Statuario Select Mosaico Esagono Lappato  
30x35 cm - 11<sup>3</sup>/<sub>4</sub>"x13<sup>3</sup>/<sub>4</sub>"



Marvel Grey Fleury Mosaico Esagono Lappato  
30x35 cm - 11<sup>3</sup>/<sub>4</sub>"x13<sup>3</sup>/<sub>4</sub>"



Marvel Noir St.Laurent Mosaico Esagono Lappato  
30x35 cm - 11<sup>3</sup>/<sub>4</sub>"x13<sup>3</sup>/<sub>4</sub>"



Marvel Crema Delicata Mosaico Esagono Lappato  
30x35 cm - 11<sup>3</sup>/<sub>4</sub>"x13<sup>3</sup>/<sub>4</sub>"



Marvel Travertino Alabastrino Mosaico Esagono Lappato  
30x35 cm - 11<sup>3</sup>/<sub>4</sub>"x13<sup>3</sup>/<sub>4</sub>"



Marvel Travertino Silver Mosaico Esagono Lappato  
30x35 cm - 11<sup>3</sup>/<sub>4</sub>"x13<sup>3</sup>/<sub>4</sub>"



Marvel Mosaico Esagono Multicolor Cold  
30x35 cm - 11<sup>3</sup>/<sub>4</sub>"x13<sup>3</sup>/<sub>4</sub>"



Marvel Mosaico Esagono Multicolor Warm  
30x35 cm - 11<sup>3</sup>/<sub>4</sub>"x13<sup>3</sup>/<sub>4</sub>"

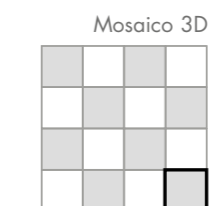

Mosaico 3D  
7,4x7,4 cm  
2<sup>7</sup>/<sub>8</sub>"x2<sup>7</sup>/<sub>8</sub>"

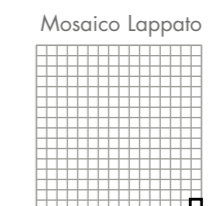

Mosaico Lappato  
1,7x1,7 cm  
5<sup>5</sup>/<sub>8</sub>"x5<sup>5</sup>/<sub>8</sub>"

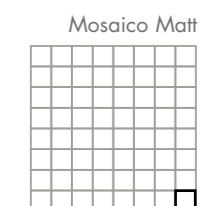

Mosaico Matt  
3,5x3,5 cm  
1<sup>3</sup>/<sub>8</sub>"x1<sup>3</sup>/<sub>8</sub>"

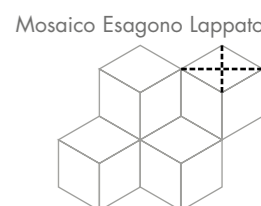

Mosaico Esagono Lappato  
10x17 cm  
3<sup>7</sup>/<sub>8</sub>"x6<sup>3</sup>/<sub>4</sub>"

**Mosaico Esagono Multicolor Cold:** Statuario Select + Grey Fleury + Noir St.Laurent

**Mosaico Esagono Multicolor Warm:** Crema Delicata + Travertino Alabastrino + Noir St.Laurent

DESTINATIONS OF USE / DESTINAZIONI D'USO



**HEAVY TRAFFIC**  
CALPESTIO PESANTE

HEAVY COMMERCIAL AREAS (malls, airports, places of worship, schools, museums, squares, hospitals, etc.)  
COMMERCIALI PESANTI (mall, aeroporti, luoghi di culto, scuole, musei, piazze, ospedali etc.)



MOSAICS / MOSAICI



Marvel Mosaico Honeycomb  
Cold Lappato  
30x49 cm - 11<sup>3</sup>/<sub>4</sub>"x19<sup>1</sup>/<sub>4</sub>"



Marvel Mosaico Honeycomb  
Warm Lappato  
30x49 cm - 11<sup>3</sup>/<sub>4</sub>"x19<sup>1</sup>/<sub>4</sub>"

**Mosaico Honeycomb Cold:**  
Statuario Select + Noir St.Laurent

**Mosaico Honeycomb Warm:**  
Crema Delicata + Noir St.Laurent



Marvel Mosaico Honeycomb Warm Lappato 30x49 cm

Mosaico Honeycomb Lappato

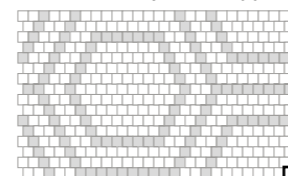

1,7x1,7 cm - 5/8"x5/8"



Marvel Mosaico Circle Lappato  
30x30 cm - 11<sup>3</sup>/<sub>4</sub>"x11<sup>3</sup>/<sub>4</sub>"

**Mosaico Circle Lappato:**  
Noir St.Laurent + Crema Delicata

Mosaico  
Circle Lappato

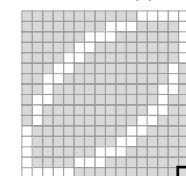

1,7x1,7 cm - 5/8"x5/8"





ELEGANCE



Marvel Elegance Angolo Dark ••  
60x60 cm - 23<sup>5</sup>/<sub>8</sub>"x23<sup>5</sup>/<sub>8</sub>"

Marvel Elegance Fascia Dark •  
60x60 cm - 23<sup>5</sup>/<sub>8</sub>"x23<sup>5</sup>/<sub>8</sub>"

**Elegance Angolo, Elegance Fascia:**  
Crema Delicato + Travertino Alabastrino + Grey Fleury + Noir St.Laurent

- Not matching with sizes 59x59 cm, 29,5x59 cm  
Non abbinabile ai formati 59x59 cm, 29,5x59 cm  
Ne peut être assorti aux formats 59x59 cm, 29,5x59 cm  
Nicht mit den Formaten 59x59 cm, 29,5x59 cm kombinierbar  
No combinable con los formatos 59x59 cm, 29,5x59 cm  
Не сочет ется с форм т ми 59x59 см, 29,5x59 см

- To be ordered in multiples of 4  
Ordinabile in multipli di 4  
Peut être commandé en multiples de 4  
Zum Bestellen als Vielfache von 4  
Es posible efectuar pedidos en múltiplos de 4  
З к зыв ются в количестве кр тном 4



LISTELS / LISTELLI

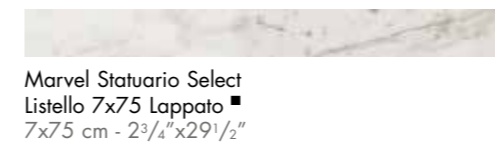

Marvel Statuario Select  
Listello 7x75 Lappato •  
7x75 cm - 2<sup>3</sup>/<sub>4</sub>"x29<sup>1</sup>/<sub>2</sub>"

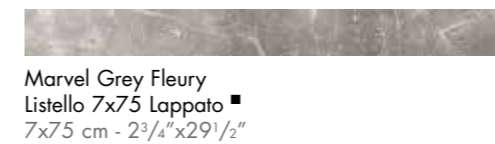

Marvel Grey Fleury  
Listello 7x75 Lappato •  
7x75 cm - 2<sup>3</sup>/<sub>4</sub>"x29<sup>1</sup>/<sub>2</sub>"



Marvel Noir St.Laurent  
Listello 7x75 Lappato •  
7x75 cm - 2<sup>3</sup>/<sub>4</sub>"x29<sup>1</sup>/<sub>2</sub>"

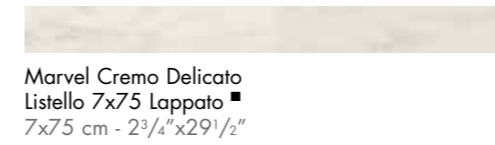

Marvel Crema Delicato  
Listello 7x75 Lappato •  
7x75 cm - 2<sup>3</sup>/<sub>4</sub>"x29<sup>1</sup>/<sub>2</sub>"

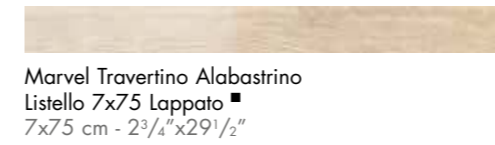

Marvel Travertino Alabastrino  
Listello 7x75 Lappato •  
7x75 cm - 2<sup>3</sup>/<sub>4</sub>"x29<sup>1</sup>/<sub>2</sub>"



Marvel Travertino Silver  
Listello 7x75 Lappato •  
7x75 cm - 2<sup>3</sup>/<sub>4</sub>"x29<sup>1</sup>/<sub>2</sub>"

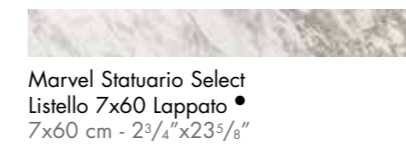

Marvel Statuario Select  
Listello 7x60 Lappato •  
7x60 cm - 2<sup>3</sup>/<sub>4</sub>"x23<sup>5</sup>/<sub>8</sub>"

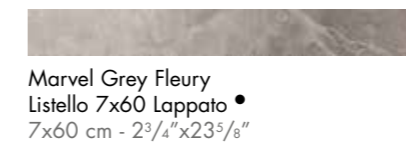

Marvel Grey Fleury  
Listello 7x60 Lappato •  
7x60 cm - 2<sup>3</sup>/<sub>4</sub>"x23<sup>5</sup>/<sub>8</sub>"



Marvel Noir St.Laurent  
Listello 7x60 Lappato •  
7x60 cm - 2<sup>3</sup>/<sub>4</sub>"x23<sup>5</sup>/<sub>8</sub>"

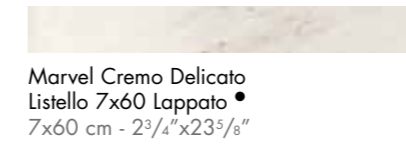

Marvel Crema Delicato  
Listello 7x60 Lappato •  
7x60 cm - 2<sup>3</sup>/<sub>4</sub>"x23<sup>5</sup>/<sub>8</sub>"

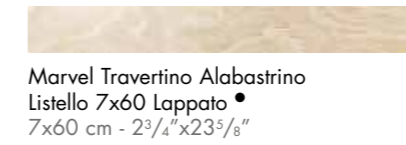

Marvel Travertino Alabastrino  
Listello 7x60 Lappato •  
7x60 cm - 2<sup>3</sup>/<sub>4</sub>"x23<sup>5</sup>/<sub>8</sub>"



Marvel Travertino Silver  
Listello 7x60 Lappato •  
7x60 cm - 2<sup>3</sup>/<sub>4</sub>"x23<sup>5</sup>/<sub>8</sub>"

- Not matching with sizes 74x148 cm, 74x74 cm  
Non abbinabile ai formati 74x148 cm, 74x74 cm  
Ne peut être assorti aux formats 74x148 cm, 74x74 cm  
Nicht mit den Formaten 74x148 cm, 74x74 cm kombinierbar  
No combinable con los formatos 74x148 cm, 74x74 cm  
Не сочет ется с форм т ми 74x148 см, 74x74 см

- Not matching with sizes 59x59 cm, 29,5x59 cm  
Non abbinabile ai formati 59x59 cm, 29,5x59 cm  
Ne peut être assorti aux formats 59x59 cm, 29,5x59 cm  
Nicht mit den Formaten 59x59 cm, 29,5x59 cm kombinierbar  
No combinable con los formatos 59x59 cm, 29,5x59 cm  
Не сочет ется с форм т ми 59x59 см, 29,5x59 см

LISTELLO ESAGONO

MARVEL PRO COLLECTION



Marvel Noir St.Laurent  
Listello Esagono Lappato •  
11x86 cm - 4<sup>3</sup>/<sub>8</sub>"x33<sup>7</sup>/<sub>8</sub>"

ETIC COLLECTION



Etic Rovere Bianco Esagono •  
11x86 cm - 4<sup>3</sup>/<sub>8</sub>"x33<sup>7</sup>/<sub>8</sub>"



Etic Rovere Esagono •  
11x86 cm - 4<sup>3</sup>/<sub>8</sub>"x33<sup>7</sup>/<sub>8</sub>"



Etic Noce Esagono •  
11x86 cm - 4<sup>3</sup>/<sub>8</sub>"x33<sup>7</sup>/<sub>8</sub>"



Etic Palissandro Esagono •  
11x86 cm - 4<sup>3</sup>/<sub>8</sub>"x33<sup>7</sup>/<sub>8</sub>"



Etic Ebano Esagono •  
11x86 cm - 4<sup>3</sup>/<sub>8</sub>"x33<sup>7</sup>/<sub>8</sub>"

GRECA MOSAICO



Marvel Noir/Cremo  
Greca Mosaico  
18,5x30 cm - 7<sup>1</sup>/<sub>4</sub>"x11<sup>3</sup>/<sub>4</sub>"



Marvel Noir/Cremo  
Angolo Mosaico  
18,5x18,5 cm - 7<sup>1</sup>/<sub>4</sub>"x7<sup>1</sup>/<sub>4</sub>"

**Greca Mosaico, Angolo Mosaico:**  
Noir St.Laurent + Crema Delicato

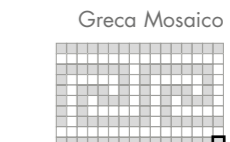

Greca Mosaico  
1,7x1,7 cm - 5/8"x5/8"

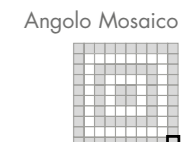

Angolo Mosaico  
1,7x1,7 cm - 5/8"x5/8"





STATUARIOSELECT

Pure grace



GREYFLEURY

Absolute rigour



NOIRSAINTLAURENT

Intense emotion



ELEGANT  
SHADES  
TONALITÀ ELEGANTI

DES COULEURS ÉLÉGANTES  
ELEGANTE FARBEN  
TONALIDADES ELEGANTES  
ЭЛЕГАНТНЫЕ ТОНА

COLOUR-SHADING  
STONALIZZAZIONE

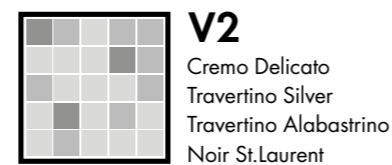

V2  
Cremo Delicato  
Travertino Silver  
Travertino Alabastrino  
Noir St.Laurent

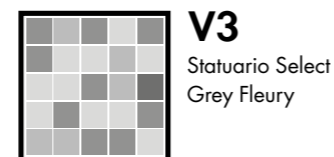

V3  
Statuario Select  
Grey Fleury



V1  
Light  
Leggera  
Leicht  
Ligera  
Лёгкое

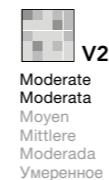

V2  
Moderate  
Moderata  
Moyen  
Moderada  
Умеренное



V3  
High  
Alta  
Haut  
Kräftigere  
Alta  
Высокое



V4  
Random  
Random  
Casuel  
Zufällige  
Random  
Произвольное



CREMODELICATO

Refined nature



TRAVERTINOALABASTRINO

Contemporary luxury



TRAVERTINOSILVER

Eternal allure





Marvel Statuario Select 91  
30,5x91,5 cm - 12"x36"



Marvel Grey Fleury 91  
30,5x91,5 cm - 12"x36"



Marvel Noir St.Laurent 91  
30,5x91,5 cm - 12"x36"

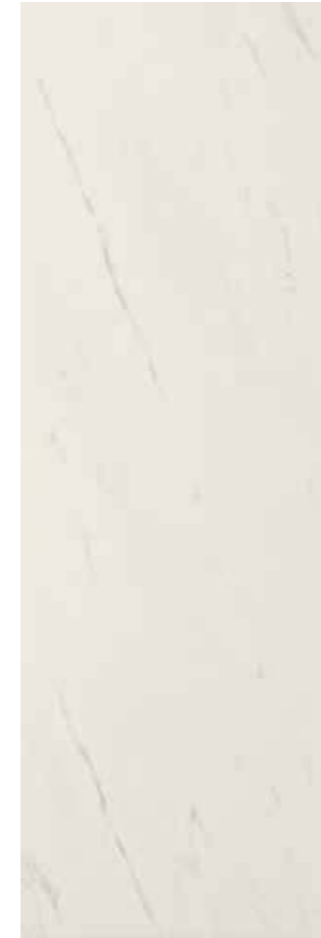

Marvel Crema Delicata 91  
30,5x91,5 cm - 12"x36"



Marvel Travertino Alabastrino 91  
30,5x91,5 cm - 12"x36"



Marvel Travertino Silver 91  
30,5x91,5 cm - 12"x36"



Marvel Statuario Select Alzata  
20x30,5 cm - 7<sup>7</sup>/<sub>8</sub>"x12"



Marvel Statuario Select Alzata A.E.  
1,5x20 cm - 5<sup>5</sup>/<sub>8</sub>"x7<sup>7</sup>/<sub>8</sub>"



Marvel Grey Fleury Alzata  
20x30,5 cm - 7<sup>7</sup>/<sub>8</sub>"x12"



Marvel Grey Fleury Alzata A.E.  
1,5x20 cm - 5<sup>5</sup>/<sub>8</sub>"x7<sup>7</sup>/<sub>8</sub>"



Marvel Noir St.Laurent Alzata  
20x30,5 cm - 7<sup>7</sup>/<sub>8</sub>"x12"



Marvel Noir St.Laurent Alzata A.E.  
1,5x20 cm - 5<sup>5</sup>/<sub>8</sub>"x7<sup>7</sup>/<sub>8</sub>"



Marvel Crema Delicata Alzata  
20x30,5 cm - 7<sup>7</sup>/<sub>8</sub>"x12"



Marvel Crema Delicata Alzata A.E.  
1,5x20 cm - 5<sup>5</sup>/<sub>8</sub>"x7<sup>7</sup>/<sub>8</sub>"



Marvel Travertino Alabastrino Alzata  
20x30,5 cm - 7<sup>7</sup>/<sub>8</sub>"x12"



Marvel Travertino Alabastrino Alzata A.E.  
1,5x20 cm - 5<sup>5</sup>/<sub>8</sub>"x7<sup>7</sup>/<sub>8</sub>"



Marvel Travertino Silver Alzata  
20x30,5 cm - 7<sup>7</sup>/<sub>8</sub>"x12"



Marvel Travertino Silver Alzata A.E.  
1,5x20 cm - 5<sup>5</sup>/<sub>8</sub>"x7<sup>7</sup>/<sub>8</sub>"



Marvel Statuario Select London  
5x30,5 cm - 2"x12"



Marvel Statuario Select London A.E.  
5x2,5 cm - 2"x1"



Marvel Grey Fleury London  
5x30,5 cm - 2"x12"



Marvel Grey Fleury London A.E.  
5x2,5 cm - 2"x1"



Marvel Noir St.Laurent London  
5x30,5 cm - 2"x12"



Marvel Noir St.Laurent London A.E.  
5x2,5 cm - 2"x1"



Marvel Crema Delicata London  
5x30,5 cm - 2"x12"



Marvel Crema Delicata London A.E.  
5x2,5 cm - 2"x1"



Marvel Travertino Alabastrino London  
5x30,5 cm - 2"x12"



Marvel Travertino Alabastrino London A.E.  
5x2,5 cm - 2"x1"



Marvel Travertino Silver London  
5x30,5 cm - 2"x12"



Marvel Travertino Silver London A.E.  
5x2,5 cm - 2"x1"



Marvel Statuario Select Spigolo  
0,85x30,5 cm - 3<sup>3</sup>/<sub>8</sub>"x12"



Marvel Statuario Select Spigolo A.E.  
0,85x0,85 cm - 3<sup>3</sup>/<sub>8</sub>"x3<sup>3</sup>/<sub>8</sub>"



Marvel Grey Fleury Spigolo  
0,85x30,5 cm - 3<sup>3</sup>/<sub>8</sub>"x12"



Marvel Grey Fleury Spigolo A.E.  
0,85x0,85 cm - 3<sup>3</sup>/<sub>8</sub>"x3<sup>3</sup>/<sub>8</sub>"



Marvel Noir St.Laurent Spigolo  
0,85x30,5 cm - 3<sup>3</sup>/<sub>8</sub>"x12"



Marvel Noir St.Laurent Spigolo A.E.  
0,85x0,85 cm - 3<sup>3</sup>/<sub>8</sub>"x3<sup>3</sup>/<sub>8</sub>"

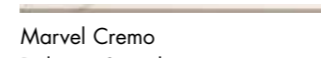

Marvel Crema Delicata Spigolo  
0,85x30,5 cm - 3<sup>3</sup>/<sub>8</sub>"x12"



Marvel Crema Delicata Spigolo A.E.  
0,85x0,85 cm - 3<sup>3</sup>/<sub>8</sub>"x3<sup>3</sup>/<sub>8</sub>"



Marvel Travertino Alabastrino Spigolo  
0,85x30,5 cm - 3<sup>3</sup>/<sub>8</sub>"x12"



Marvel Travertino Alabastrino Spigolo A.E.  
0,85x0,85 cm - 3<sup>3</sup>/<sub>8</sub>"x3<sup>3</sup>/<sub>8</sub>"



Marvel Travertino Silver Spigolo  
0,85x30,5 cm - 3<sup>3</sup>/<sub>8</sub>"x12"



Marvel Travertino Silver Spigolo A.E.  
0,85x0,85 cm - 3<sup>3</sup>/<sub>8</sub>"x3<sup>3</sup>/<sub>8</sub>"





Marvel Statuario Select 80  
40x80 cm - 15<sup>3</sup>/<sub>4</sub>"x31<sup>1</sup>/<sub>2</sub>"



Marvel Crema Delicata 80  
40x80 cm - 15<sup>3</sup>/<sub>4</sub>"x31<sup>1</sup>/<sub>2</sub>"

**RIBBON 3D WALL DESIGN** ✂ 10 mm



Marvel Statuario Select Ribbon  
40x80 cm - 15<sup>3</sup>/<sub>4</sub>"x31<sup>1</sup>/<sub>2</sub>"



Marvel Crema Delicata Ribbon  
40x80 cm - 15<sup>3</sup>/<sub>4</sub>"x31<sup>1</sup>/<sub>2</sub>"



Marvel Grey Fleury 80  
40x80 cm - 15<sup>3</sup>/<sub>4</sub>"x31<sup>1</sup>/<sub>2</sub>"



Marvel Travertino Alabastrino 80  
40x80 cm - 15<sup>3</sup>/<sub>4</sub>"x31<sup>1</sup>/<sub>2</sub>"



Marvel Grey Fleury Ribbon  
40x80 cm - 15<sup>3</sup>/<sub>4</sub>"x31<sup>1</sup>/<sub>2</sub>"



Marvel Noir St.Laurent Ribbon  
40x80 cm - 15<sup>3</sup>/<sub>4</sub>"x31<sup>1</sup>/<sub>2</sub>"



Marvel Noir St.Laurent 80  
40x80 cm - 15<sup>3</sup>/<sub>4</sub>"x31<sup>1</sup>/<sub>2</sub>"



Marvel Travertino Silver 80  
40x80 cm - 15<sup>3</sup>/<sub>4</sub>"x31<sup>1</sup>/<sub>2</sub>"



HEXAGON



Marvel Grey Fleury Hexagon  
40x80 cm - 15<sup>3</sup>/<sub>4</sub>"x31<sup>1</sup>/<sub>2</sub>"



MOSAICS / MOSAICI ♦

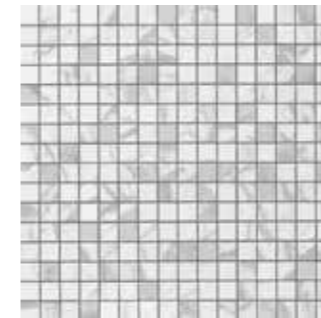

Marvel Statuario Select  
Mosaic  
30,5x30,5 cm - 12"x12"

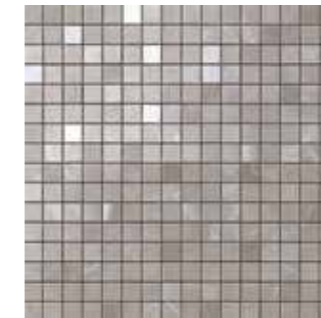

Marvel Grey Fleury  
Mosaic  
30,5x30,5 cm - 12"x12"

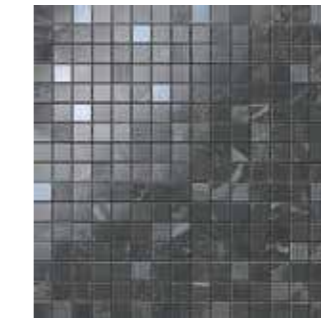

Marvel Noir St.Laurent  
Mosaic  
30,5x30,5 cm - 12"x12"

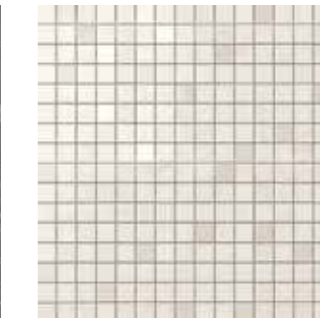

Marvel Crema Delicato  
Mosaic  
30,5x30,5 cm - 12"x12"



Marvel Travertino Alabastrino  
Mosaic  
30,5x30,5 cm - 12"x12"



Marvel Travertino Silver  
Mosaic  
30,5x30,5 cm - 12"x12"

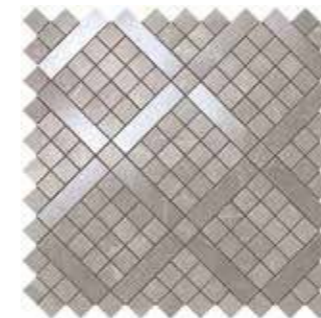

Marvel Grey Fleury  
Diagonal Mosaic  
30,5x30,5 cm - 12"x12"

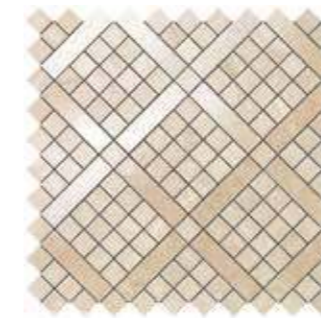

Marvel Travertino Alabastrino  
Diagonal Mosaic  
30,5x30,5 cm - 12"x12"

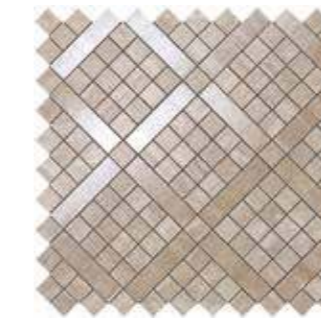

Marvel Travertino Silver  
Diagonal Mosaic  
30,5x30,5 cm - 12"x12"



Marvel Noir Mix  
Diagonal Mosaic ♦  
30,5x30,5 cm - 12"x12"



Marvel Crema Mix  
Diagonal Mosaic ♦  
30,5x30,5 cm - 12"x12"

♦ Noir Mix: Noir St. Laurent + Statuario Select  
Crema Mix: Crema Delicato + Noir St. Laurent



Marvel Grey Fleury Net Mosaic  
30,5x30,5 cm - 12"x12"



Marvel Travertino Silver Net Mosaic  
30,5x30,5 cm - 12"x12"

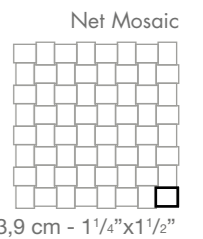
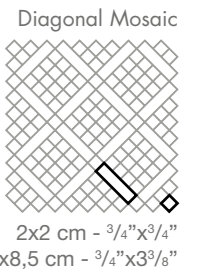
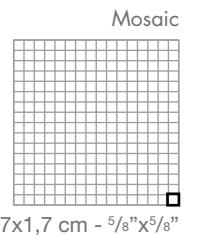

Matching with both sizes 30,5x91,5 cm and 40x80 cm  
Abbinabili a entrambi i formati 30,5x91,5 cm e 40x80 cm  
Combinables avec les deux formats 30,5x91,5 cm et 40x80 cm  
Kombinierbar mit den beiden Formaten 30,5x91,5 cm und 40x80 cm  
Combinables con ambos formatos 30,5x91,5 cm y 40x80 cm  
Сочет ется с обоими форм т ми: 30,5x91,5 см и 40x80 см



BROCADE



Marvel Travertino Alabastrino Brocade  
30,5x91,5 cm - 12"x36"



Marvel Noir St.Laurent Brocade  
30,5x91,5 cm - 12"x36"



GOLD

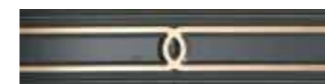

Marvel Gold Black  
7,8x30,5 cm - 3 1/8"x12"



Marvel Gold Black A.E.  
7,8x1,2 cm - 3 1/8"x1/2"



Marvel Gold White  
7,8x30,5 cm - 3 1/8"x12"



Marvel Gold White A.E.  
7,8x1,2 cm - 3 1/8"x1/2"

- Decor with GOLD insert
- Decoro con inserto in ORO
- Décor avec insert en OR
- Dekor mit Einlage GOLD
- Decoración con aplicación de ORO
- Декор с ЗОЛОТОЙ вст вкой





COLOURED BODY PORCELAIN TILES - RECTIFIED MONOCALIBER GRES PORCELLANATO COLORATO IN MASSA - RETTIFICATO MONOCALIBRO

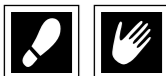

75x150 cm 29 1/2"x59"	± 10 mm - Honed	60x60 cm 23 3/8"x23 3/8"	± 10 mm - Honed	45x90 cm 17 3/4"x35 3/8"	± 10 mm - Matt	45x90 cm 17 3/4"x35 3/8"	± 20 mm LASTRA
75x75 cm 29 1/2"x29 1/2"	± 10 mm - Honed	60x60 cm 23 3/8"x23 3/8"	± 10 mm - Honed	60x60 cm 23 3/8"x23 3/8"	± 10 mm - Matt	60x60 cm 23 3/8"x23 3/8"	± 20 mm LASTRA
45x90 cm 17 3/4"x35 3/8"	± 10 mm - Honed	60x60 cm 23 3/8"x23 3/8"	± 10 mm - Satin	30x60 cm 11 3/4"x23 3/8"	± 10 mm - Matt / Textured		



Compliant with standards EN 14411:2012 annex G group Bla Conforme alla norma EN 14411:2012 Appendice G gruppo Bla  
 Compliant with standards ISO 13006:2012 annex G group Bla Conforme alla norma ISO 13006:2012 Appendice G gruppo Bla

	Technical features Caratteristiche tecniche	Test Method Metodo di prova	Requirements for nominal size N Requisiti per dimensione nominale N				MARVEL PRO Floor Design							
			7 cm ≤ N < 15 cm		N ≥ 15 cm		Honed / Satin	Matt	Textured	Lastra 20 mm				
			(mm)	(%)	(mm)	(mm)								
REGULARITY CHARACTERISTICS CARATTERISTICHE DI REGOLARITÀ		ISO 10545-2	Length and width Lunghezza e larghezza				± 0,9 <sup>(*)</sup>	± 0,6 <sup>(*)</sup>	± 2,0 <sup>(*)</sup>	± 0,2% ± 0,8 mm	± 0,2% ± 0,8 mm	± 0,2% ± 0,8 mm	± 0,2% ± 0,8 mm	
			Thickness Spessore				± 0,5 <sup>(**)</sup>	± 5 <sup>(**)</sup>	± 0,5 <sup>(**)</sup>	± 5,0% ± 0,5 mm	± 5,0% ± 0,5 mm	± 5,0% ± 0,5 mm	± 5,0% ± 0,5 mm	
			Straightness of sides Rettilinearità degli spigoli				± 0,75 <sup>(***)</sup>	± 0,5 <sup>(***)</sup>	± 1,5 <sup>(***)</sup>	± 0,2% ± 0,8 mm	± 0,2% ± 0,8 mm	± 0,2% ± 0,8 mm	± 0,2% ± 0,8 mm	
			Rectangularity Ortogonalità				± 0,75 <sup>(****)</sup>	± 0,5 <sup>(****)</sup>	± 2,0 <sup>(****)</sup>	± 0,2% ± 0,8 mm	± 0,2% ± 0,8 mm	± 0,2% ± 0,8 mm	± 0,2% ± 0,8 mm	
			Surface flatness Planarità				c.c. ± 0,75 e.c. ± 0,75 w. ± 0,75	c.c. ± 0,5 e.c. ± 0,5 w. ± 0,5	c.c. ± 2,0 e.c. ± 2,0 w. ± 2,0	± 0,3% ± 1,5 mm	± 0,3% ± 1,3 mm	± 0,3% ± 1,3 mm	± 0,3% ± 1,3 mm	
			EN 14411 annex G (Group Bla) EN 14411 appendice G (Gruppo Bla)	ISO 13006 annex G (Group Bla) ISO 13006 appendice G (Gruppo Bla)										
STRUCTURAL CHARACTERISTICS CARATTERISTICHE STRUTTURALI		ISO 10545-3	Water absorption Massa d'acqua assorbita				E <sub>3</sub> ≤ 0,5% Individual Maximum 0,6% E <sub>3</sub> ≤ 0,5% Valore massimo singolo 0,6%	≤ 0,1 %	≤ 0,1 %	≤ 0,1 %	≤ 0,1 %			
BULK MECHANICAL CHARACTERISTICS CARATTERISTICHE MECCANICHE MASSIVE		ISO 10545-4	Breaking strength Sforzo di rottura				S ≥ 1300 N	S ≥ 1500 N	S ≥ 1500 N	S ≥ 1500 N	S ≥ 10000 N			
			Modulus of rupture Resistenza alla flessione				R ≥ 35 N/mm <sup>2</sup>	R ≥ 40 N/mm <sup>2</sup>	R ≥ 40 N/mm <sup>2</sup>	R ≥ 40 N/mm <sup>2</sup>	R ≥ 45 N/mm <sup>2</sup>			
SURFACE MECHANICAL CHARACTERISTICS CARATTERISTICHE MECCANICHE SUPERFICIALI		ISO 10545-5	Impact resistance, as coefficient of restitution Resistenza all'impatto, espresso come coefficiente di restituzione				Declared value Dichiarare un valore	Test method available Metodo di prova disponibile	≥ 0,55	≥ 0,55	≥ 0,55	≥ 0,55		
			EN 101 <sup>(5)</sup>	Mohs hardness Durezza Mohs				≥ 6 (UGL)	5	Suitable for Conforme	7	8		
THERMAL AND HYGROMETRIC CHARACTERISTICS CARATTERISTICHE TERMO IGROMETRICHE		ISO 10545-6	Resistance to deep abrasion of unglazed tiles (removed volume) Resistenza all'abrasione profonda delle piastrelle non smaltate (volume materiale asportato)				≤ 175 mm <sup>3</sup>	≤ 150 mm <sup>3</sup>	≤ 150 mm <sup>3</sup>	≤ 150 mm <sup>3</sup>	≤ 150 mm <sup>3</sup>			
			ISO 10545-8	Coefficient of thermal linear expansion Coefficiente di dilatazione termica lineare				Declared value Dichiarare un valore	Test method available Metodo di prova disponibile	≤ 7 MK <sup>-1</sup>	≤ 7 MK <sup>-1</sup>	≤ 7 MK <sup>-1</sup>	≤ 7 MK <sup>-1</sup>	
			ISO 10545-9	Thermal shock resistance Resistenza agli sbalzi termici				Pass according to ISO 10545-1 Test superato in accordo con ISO 10545-1	Test method available Metodo di prova disponibile	Resistant Resiste	Resistant Resiste	Resistant Resiste	Resistant Resiste	
			ISO 10545-10	Moisture expansion (in mm/m) Dilatazione all'umidità (in mm/m)				Declared value Dichiarare un valore	Test method available Metodo di prova disponibile	≤ 0,01% (0,1mm/m)	≤ 0,01% (0,1mm/m)	≤ 0,01% (0,1mm/m)	≤ 0,01% (0,1mm/m)	
PHYSICAL PROPERTIES PROPRIETÀ FISICHE		EN 1348	Bond strength/adhesion for improved cementitious adhesives Adesione a trazione con adesivi cementizi migliorati				Declared value Dichiarare un valore	-	≥ 1,0 N/mm <sup>2</sup> (Class C2 - EN 12004)	≥ 1,0 N/mm <sup>2</sup> (Class C2 - EN 12004)	≥ 1,0 N/mm <sup>2</sup> (Class C2 - EN 12004)	≥ 1,0 N/mm <sup>2</sup> (Class C2 - EN 12004)		
			-	Reaction to fire Reazione al fuoco				Class A1 or A1 <sub>s</sub> Classe A1 oppure A1 <sub>s</sub>	-	A1 - A1 <sub>s</sub>	A1 - A1 <sub>s</sub>	A1 - A1 <sub>s</sub>		
CHEMICAL CHARACTERISTICS CARATTERISTICHE CHIMICHE		ISO 10545-13	Resistance to household chemicals and swimming pool salts Resistenza ai prodotti chimici di uso domestico ed agli additivi per piscina				Minimum Class B (U for unglazed tiles) Classe minima B (U per piastrelle non smaltate)				UA	UA	UA	UA
			Resistance to low concentrations of acids and alkalis Resistenza a basse concentrazioni di acidi e alcali				Declared Class Dichiarare una Classe	Test method available Metodo di prova disponibile	Manufacturer is to state classification Secondo la classificazione indicata dal fabbricante	ULA	ULA	ULA	ULA	
			Resistance to high concentrations of acids and alkalis Resistenza ad alte concentrazioni di acidi e alcali				Declared Class Dichiarare una Classe	Test method available Metodo di prova disponibile	-	UHA	UHA	UHA	UHA	
			Resistance to staining Resistenza alle macchie				Declared Class Dichiarare una Classe	Test method available Metodo di prova disponibile	5	5	5	5		
SAFETY CHARACTERISTICS <sup>(6)</sup> CARATTERISTICHE DI SICUREZZA <sup>(6)</sup>		DIN 51097 (CEN/TS 16165, Annex A)	Barefoot Ramp Test Metodo della rampa a piedi nudi				Declared value Dichiarare un valore	-	0	A	A+B	A+B+C		
			DIN 51130 (CEN/TS 16165, Annex B)	Shod Ramp Test Metodo della rampa "calzata"				Declared value Dichiarare un valore	-	N.C.	R9	R11	R11	
				UNE-ENV 12633 (CEN/TS 16165, Annex C)	Pendulum Friction Test Metodo del Pendolo				Declared value Dichiarare un valore	-	Class 0	Class 1	Class 3	Class 3
SAFETY CHARACTERISTICS CARATTERISTICHE DI SICUREZZA		B.S. 7976-2002 (CEN/TS 16165, Annex C)	Pendulum Friction Test Metodo del Pendolo				Declared value Dichiarare un valore	-	PTV > 36 Dry PTV > 24 Wet	PTV > 36 Dry PTV > 35 Wet	PTV > 36 Dry PTV > 36 Wet	PTV > 36 Dry PTV > 36 Wet		
			B.C.R.A. Rep. CEC/81	Coefficient of friction (COF) Coefficiente di attrito				D. M. 236/89 del 14/08/89 μ > 0,40 per elemento scivolante cuoio su pavimentazione asciutta μ > 0,40 per elemento scivolante gomma dura su pavimentazione bagnata	> 0,40 Asciutto < 0,40 Bagnato	> 0,40 Asciutto > 0,40 Bagnato	> 0,40 Asciutto > 0,40 Bagnato	> 0,40 Asciutto > 0,40 Bagnato		
				Dynamic coefficient of friction (DCOF) Coefficiente di attrito dinamico				ANSI A137.1-2012	ANSI A.137.1 Requires a minimum value of 0.42 for commercial areas that are likely to be wet.	< 0,42 Wet	> 0,42 Wet	> 0,42 Wet	> 0,42 Wet	
				Static coefficient of friction (SCOF) Coefficiente di attrito statico				ASTM C1028-2007	The Ceramic Tiles Institute identifies Tile Slip Resistant when SCOF ≥ 0,60	≥ 0,60 Dry 0,50-0,60 Wet	≥ 0,60 Dry ≥ 0,60 Wet	≥ 0,60 Dry ≥ 0,60 Wet	≥ 0,80 Dry ≥ 0,80 Wet	
SAFETY CHARACTERISTICS CARATTERISTICHE DI SICUREZZA		AS/NZS 4586-2013, Appendix A (Four S rubber)	Pendulum Friction Test Metodo del Pendolo				Declared Classification of the pedestrian surface materials according to the Wet Pendulum Test	Class P1	Class P2	Class P4	Class P4			

<sup>(\*)</sup> The permissible deviation, in % or mm, of the average size for each tile (2 or 4 sides) from work size (W). Deviazione ammissibile, in % oppure mm, della dimensione media di ogni piastrella (2 oppure 4 lati) dalla dimensione di fabbricazione (W).  
<sup>(\*\*)</sup> The permissible deviation, in % or mm, of the average thickness for each tile from the work size thickness (W). Deviazione ammissibile, in % oppure mm, dello spessore medio di ogni piastrella dallo spessore riportato nella dimensione di fabbricazione (W).  
<sup>(\*\*\*)</sup> The maximum permissible deviation from straightness, in % or mm, related to the corresponding work sizes (W). Deviazione massima ammissibile di rettilinearità, in % oppure mm, in rapporto alle dimensioni di fabbricazione (W) corrispondenti.  
<sup>(\*\*\*\*)</sup> The maximum permissible deviation from rectangularity, in % or mm, related to the corresponding work sizes (W). Deviazione massima ammissibile di ortogonalità, in % oppure mm, in rapporto alle dimensioni di fabbricazione (W) corrispondenti.  
 c.c. The maximum permissible deviation from centre curvature, in % or mm, related to diagonal calculated from the work sizes (W). Deviazione massima ammissibile della curvatura del centro, in % oppure mm, in rapporto alla diagonale calcolata secondo le dimensioni di fabbricazione (W).  
 e.c. The maximum permissible deviation from edge curvature, in % or mm, related to the corresponding work sizes (W). Deviazione massima ammissibile della curvatura dello spigolo, in % oppure mm, in rapporto alle dimensioni di fabbricazione (W) corrispondenti.  
 w. The maximum permissible deviation from warpage, in % or mm, related to diagonal calculated from the work sizes (W). Deviazione massima ammissibile dello svergolamento, in % oppure mm, in rapporto alla diagonale calcolata secondo le dimensioni di fabbricazione (W).  
 (1). Requirements european standard EN 176. Requisiti richiesti normativa europea EN 176.  
 (2). Determination of slip resistance of pedestrian surfaces; it does not cover sports surfaces and road surfaces for vehicles (skid resistance). Determinazione della resistenza allo scivolamento delle superfici pedonabili; non si applica alle pavimentazioni sportive ed alle pavimentazioni stradali veicolari.

WHITE-BODY WALL TILES - RECTIFIED MONOCALIBER RIVESTIMENTI IN PASTA BIANCA - RETTIFICATO MONOCALIBRO

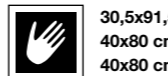

30,5x91,5 cm 12"x36"	± 8,5 mm
40x80 cm 15 3/4"x31 1/2"	± 8,5 mm
40x80 cm 15 3/4"x31 1/2"	± 10 mm RIBBON



Compliant with standards EN 14411:2012 annex L group BIII Conforme alla norma EN 14411:2012 Appendice L gruppo BIII  
 Compliant with standards ISO 13006:2012 annex L group BIII Conforme alla norma ISO 13006:2012 Appendice L gruppo BIII

	Technical features Caratteristiche tecniche	Test Method Metodo di prova	Requirements for nominal size N Requisiti per dimensione nominale N			MARVEL PRO Wall Design			
			7 cm ≤ N < 15 cm		N ≥ 15 cm				
			(mm)	(%)	(mm)				
DIMENSIONS DIMENSIONI		ISO 10545-2	Length and width Lunghezza e larghezza			± 0,75 <sup>(*)</sup>	± 0,2% ± 0,8 mm		
			Thickness Spessore			± 0,5 <sup>(**)</sup>	± 5,0% ± 0,5 mm		
			Straightness of sides Rettilinearità degli spigoli			± 0,5 <sup>(***)</sup>	± 0,2% ± 0,8 mm		
			Rectangularity Ortogonalità			± 0,75 <sup>(****)</sup>	± 0,2% ± 0,8 mm		
			Surface flatness Planarità			c.c. ± 0,75 - 0,50 e.c. ± 0,75 - 0,50 w. ± 0,75	c.c. ± 2,0 - 1,5 e.c. ± 2,0 - 1,5 w. ± 2,0		
			EN 14411 annex L (Group BIII) EN 14411 appendice L (Gruppo BIII)	ISO 13006 annex L (Group BIII) ISO 13006 appendice L (Gruppo BIII)					
PHYSICAL PROPERTIES PROPRIETÀ FISICHE		ISO 10545-3	Water absorption Massa d'acqua assorbita			Average >10%. When the average > 20%, this shall be indicated. Individual value > 9% Media >10%. Se questo valore > 20%, deve essere indicato. Valore Singolo > 9%	10% < E <sub>3</sub> ≤ 20 %		
			ISO 10545-4	Breaking strength Sforzo di rottura			S ≥ 600 N	S ≥ 600 N	
				Modulus of rupture Resistenza alla flessione			R ≥ 15 N/mm <sup>2</sup>	R ≥ 15 N/mm <sup>2</sup>	
			ISO 10545-8	Coefficient of thermal linear expansion Coefficiente di dilatazione termica lineare			Declared value Dichiarare un valore	Test method available Metodo di prova disponibile	≤ 7 MK <sup>-1</sup>
				Thermal shock resistance Resistenza agli sbalzi termici			Pass according to ISO 10545-1 Test superato in accordo con ISO 10545-1	Test method available Metodo di prova disponibile	Resistant Resiste
			ISO 10545-10	Moisture expansion (in mm/m) Dilatazione all'umidità (in mm/m)			Declared value Dichiarare un valore	Test method available Metodo di prova disponibile	≤ 0,06% (0,6mm/m)
				Crazing resistance Resistenza al cavillo			Pass according to ISO 10545-1 Test superato in accordo con ISO 10545-1	Required Metodo di prova richiesto	Resistant Resiste
			EN 1348	Bond strength/adhesion for improved cementitious adhesives Adesione a trazione con adesivi cementizi migliorati			Declared value Dichiarare un valore	-	≥ 1,0 N/mm <sup>2</sup> (Class C2 - EN 12004)
				Reaction to fire Reazione al fuoco			Class A1 or A1 <sub>s</sub> Classe A1 oppure A1 <sub>s</sub>	-	A1
			CHEMICAL PROPERTIES PROPRIETÀ CHIMICHE		ISO 10545-13	Resistance to household chemicals and swimming pool salts Resistenza ai prodotti chimici di uso domestico ed agli additivi per piscina			Minimum Class B (GB for glazed tiles) Classe minima B (GB per piastrelle smaltate)
Resistance to low concentrations of acids and alkalis Resistenza a basse concentrazioni di acidi e alcali						Declared Class Dichiarare una Classe	Test method available Metodo di prova disponibile	GLA	
Resistance to high concentrations of acids and alkalis Resistenza ad alte concentrazioni di acidi e alcali						Declared Class Dichiarare una Classe	Test method available Metodo di prova disponibile	GHA	
Resistance to staining Resistenza alle macchie						Declared Class Dichiarare una Classe	Test method available Metodo di prova disponibile	5	
ISO 10545-15	Release of dangerous substances: Cadmium (in mg/dm <sup>2</sup> ) and Lead (in mg/dm <sup>2</sup> ) Rilascio di sostanze pericolose: Cadmio (in mg/dm <sup>2</sup> ) e Piombo (in mg/dm <sup>2</sup> )			Declared value Dichiarare un valore	Test method available Metodo di prova disponibile	≤ 0,01 mg/dm <sup>2</sup> Cd ≤ 0,1 mg/dm <sup>2</sup> Pb			

<sup>(\*)</sup> The permissible deviation, in % or mm, of the average size for each tile (2 or 4 sides) from work size (W). Deviazione ammissibile, in % oppure mm, della dimensione media di ogni piastrella (2 oppure 4 lati) dalla dimensione di fabbricazione (W).  
<sup>(\*\*)</sup> The permissible deviation, in % or mm, of the average thickness for each tile from the work size thickness (W). Deviazione ammissibile, in % oppure mm, dello spessore medio di ogni piastrella dallo spessore riportato nella dimensione di fabbricazione (W).  
<sup>(\*\*\*)</sup> The maximum permissible deviation from straightness, in % or mm, related to the corresponding work sizes (W). Deviazione massima ammissibile di rettilinearità, in % oppure mm, in rapporto alle dimensioni di fabbricazione (W) corrispondenti.  
<sup>(\*\*\*\*)</sup> The maximum permissible deviation from rectangularity, in % or mm, related to the corresponding work sizes (W). Deviazione massima ammissibile di ortogonalità, in % oppure mm, in rapporto alle dimensioni di fabbricazione (W) corrispondenti.  
 c.c. The maximum permissible deviation from centre curvature, in % or mm, related to diagonal calculated from the work sizes (W). Deviazione massima ammissibile della curvatura del centro, in % oppure mm, in rapporto alla diagonale calcolata secondo le dimensioni di fabbricazione (W).  
 e.c. The maximum permissible deviation from edge curvature, in % or mm, related to the corresponding work sizes (W). Deviazione massima ammissibile della curvatura dello spigolo, in % oppure mm, in rapporto alle dimensioni di fabbricazione (W) corrispondenti.  
 w. The maximum permissible deviation from warpage, in % or mm, related to diagonal calculated from the work sizes (W). Deviazione massima ammissibile dello svergolamento, in % oppure mm, in rapporto alla diagonale calcolata secondo le dimensioni di fabbricazione (W).



TRIM TILES / PEZZI SPECIALI  $\pm$  10 mm

Indoor trim tiles

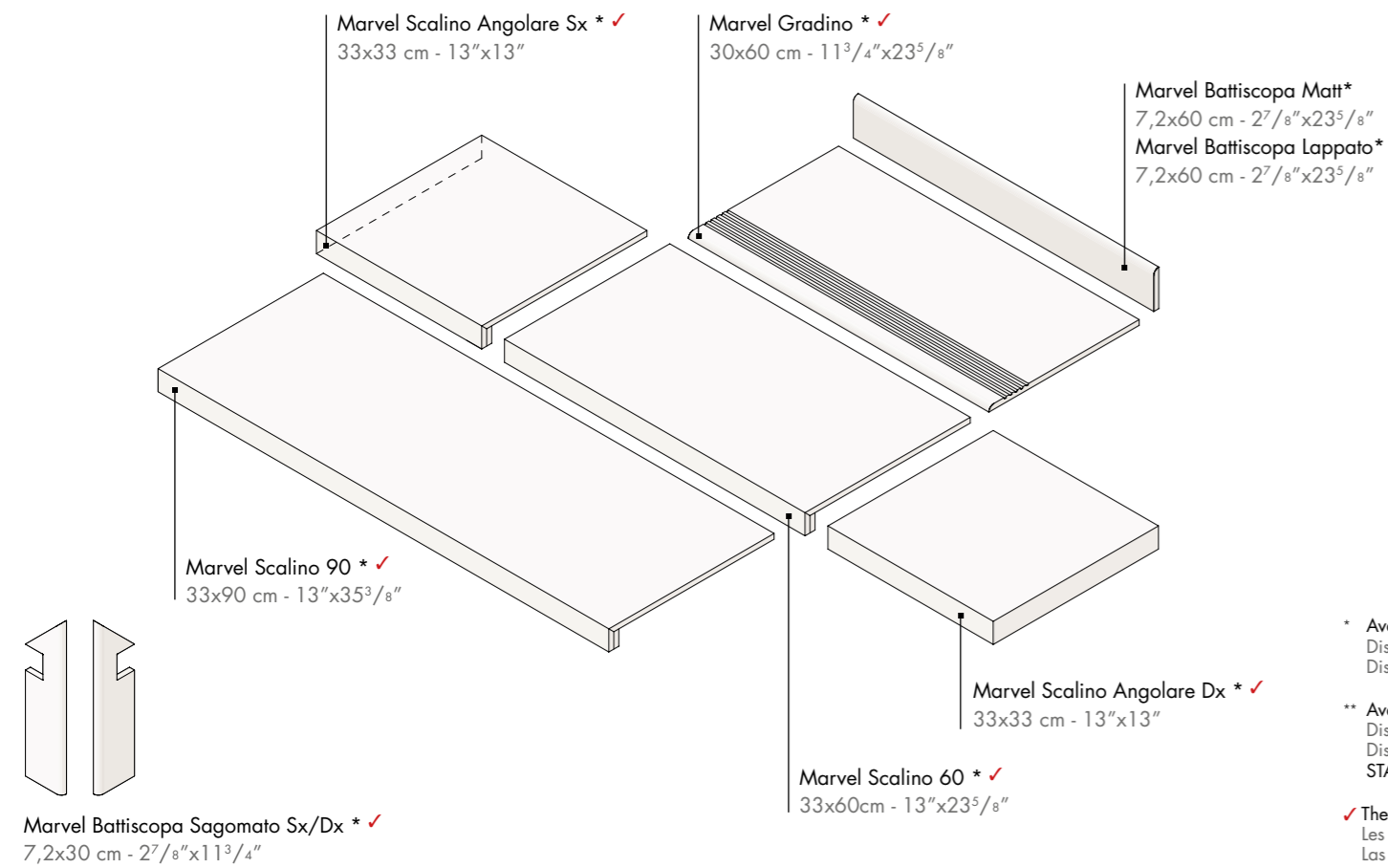

Outdoor trim tiles

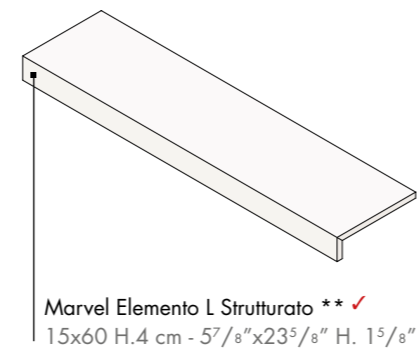

- \* Available in all colours / Disponibile in tutti i colori  
Disponible dans toutes les couleurs / In allen Farben Verfügbar  
Disponibles en todos los colores / Имеются все цвета
- \*\* Available in the following colours / Disponibile nei seguenti colori  
Disponible dans les couleurs suivantes / In folgenden Farben Verfügbar  
Disponibile en los colores / Имеющиеся цвета :  
STATUARIO SELECT, CREMO DELICATO, GREY FLEURY
- ✓ These parts are supplied to order / I pezzi sono disponibili su ordinazione  
Les pièces sont disponibles sur commande / Die Teile sind auf Bestellung lieferbar  
Las piezas se hacen por encargo / Изготавливаются н з к з

TRIM TILES / PEZZI SPECIALI  $\pm$  20 mm

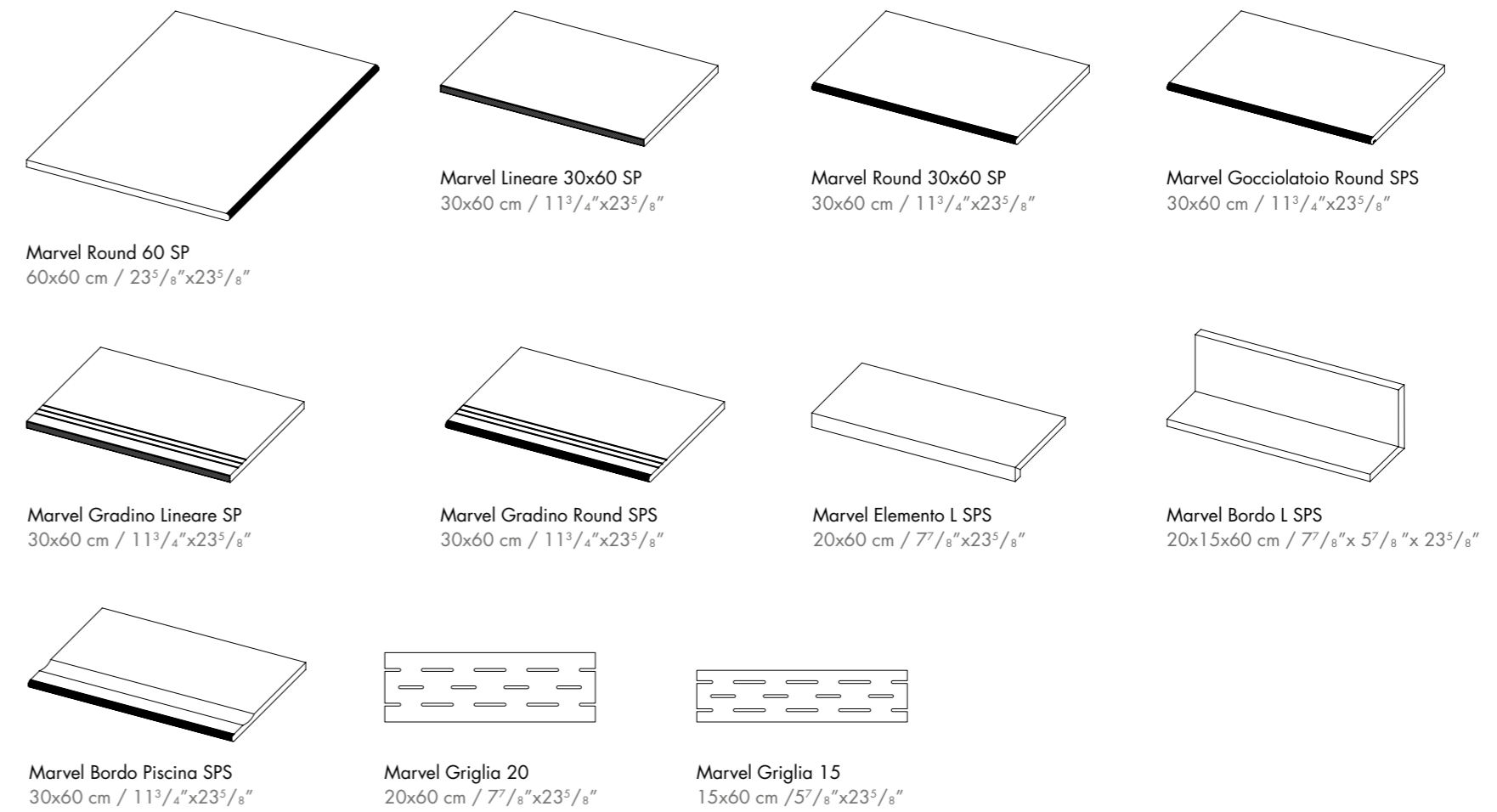

- Available in all colours / Disponibile in tutti i colori / Disponible dans toutes les couleurs / In allen Farben Verfügbar / Disponibles en todos los colores / Имеются все цвета
- For all LASTRA 20mm trims, right/left angular elements are available / Di tutti i pezzi speciali di LASTRA 20mm sono disponibili gli elementi angolari dx/sx / Parmi les pièces spéciales LASTRA 20mm, les éléments d'angle de droite et de gauche sont disponibles / Alle Formteile von LASTRA 20mm sind mit entsprechenden Eckelementen rechts/links erhältlich / Todas las piezas especiales de LASTRA 20mm disponen de los elementos angulares der./izq. correspondientes. / Для всех специальных элементов LASTRA 20mm имеются в наличии соответствующие правые/левые угловые элементы.

NOTES / NOTE

For information and details relating to codes, packaging and weight it is recommended to refer to the latest pricelist. Per le informazioni e i dati relativi a codici, imballaggi e pesi occorre sempre consultare l'ultimo listino aggiornato e in vigore. Pour toutes informations et renseignements concernant les codes, les emballages et les poids, il y a toujours lieu de consulter le dernier tarif en vigueur et mis à jour. Für Informationen und Daten die den Code, die Verpackung und das Gewicht betreffen bitte die aktuellste Preislise zugrunde legen. Para acceder a la información y a los datos relativos a códigos, embalajes y pesos hay que consultar siempre la última lista de precios actualizada y vigente. Для информации о коде, упаковке и весе обращайтесь к последнему действующему прейскуранту.

Colours and optical features of the materials illustrated in this catalogue are to be regarded as mere indications. I colori e le caratteristiche estetiche dei materiali illustrati nel presente catalogo sono da ritenersi puramente indicativi. Les coloris et les caractéristiques esthétiques des références illustrées dans le catalogue sont donnés à titre purement indicatif. Die Farben und die ästhetischen Eigenschaften der in diesem Katalog abgebildeten Produkte sind als reine Richtwerte zu betrachten. Los colores y las características estéticas de los materiales ilustrados en el presente catálogo deben ser considerados como puramente indicativos. Цвет и эстетические характеристики изделий без предварительного уведомления, отклоняя при этом любую ответственность за прямые или косвенные убытки, возникшие в результате изменений.

Atlas Concorde reserves the right to modify any product without notice and will not be liable for any direct or indirect damage resulting from such modifications. Atlas Concorde si riserva di modificare i prodotti senza preavviso, declinando ogni responsabilità su eventuali danni diretti o indiretti derivanti da eventuali modifiche. Atlas Concorde se réserve le droit de modifier ses produits sans préavis et décline toute responsabilité concernant les éventuels dommages directs ou indirects qui pourraient dériver de ces modifications. Atlas Concorde behält sich das Recht vor jederzeit und ohne vorherige Ankündigung, die Produkte zu verändern, und lehnt jede Haftung bei direkten oder indirekten Schäden ab, die von diesen Veränderungen herrühren. Atlas Concorde se reserva el derecho de modificar los productos sin previo aviso, rechaza cualquier responsabilidad sobre eventuales daños directos o indirectos derivados de eventuales modificaciones. Atlas Concorde оставляет за собой право изменять характеристики изделий без предварительного уведомления, отклоняя при этом любую ответственность за прямые или косвенные убытки, возникшие в результате изменений.







MARVEL  
PRO  
FLOOR  
& WALL

THANKS TO SÌ RINGRAZIANO

KERASAN  
www.kerasan.it

Vistosi  
www.vistosi.it

DURAVIT  
www.duravit.it

cielo  
handmade in Italy  
www.ceramicacielo.it

bongio  
www.bongio.it

LIVING  
DIVANI  
www.livingdivani.it

il fuoco degli Dei  
www.ilfuocodeglidei.com



MADE IN ITALY

The Made in Italy logo of Atlas Concorde stands for style, quality and ethics. Having firmly adhered to the Ethical Code promoted by Confindustria Ceramica, Atlas Concorde places the Made in Italy logo on all the products designed and produced in Italy, that is to say ceramic tiles, decorations and the majority of special trim tiles. Only a small amount of the latter is manufactured in Spain. Atlas Concorde products are produced using eco-friendly technologies, top quality and safe raw materials with the best working conditions guaranteed for our personnel. For these reasons, Atlas Concorde's Made in Italy is the expression of strong values such as style, design, product quality, and respect for the environment and the people who live in it.

www.confindustriaceramica.it

The Ceramics of Italy logo is an exclusive identification on ceramic products which have effectively been made in Italy by companies that are a part of the Confindustria Ceramica and who adhered to its Ethical Code. This Code, promoted and created by Confindustria Ceramica, commits all companies to communicate, clearly and with transparency, the origin of their products.

Il marchio Made in Italy di Atlas Concorde è sinonimo di stile, qualità ed etica. Avendo aderito con convinzione al Codice Etico di Confindustria Ceramica, Atlas Concorde appone il marchio Made in Italy su tutti i prodotti studiati, progettati e realizzati in Italia, nella fattispecie tutte le piastrelle di ceramica, le decorazioni e la maggioranza dei pezzi speciali. Solo un ristretto numero di questi ultimi è fabbricato in Spagna. I prodotti Atlas Concorde sono inoltre realizzati con tecnologie rispettose dell'ambiente, utilizzando materie prime eccellenti e sicure, garantendo le migliori condizioni di lavoro. Per queste ragioni il Made in Italy di Atlas Concorde è espressione di valori forti quali stile, design, qualità del prodotto, attenzione all'ambiente e alle persone.

Il marchio Ceramics of Italy contrassegna esclusivamente i prodotti ceramici effettivamente realizzati in Italia da un'azienda associata a Confindustria Ceramica che ha sottoscritto il Codice Etico. Il Codice, redatto dalla stessa Confindustria Ceramica, impegna a comunicare con chiarezza l'origine dei prodotti.

www.eco-label.com

The European logo of environmental quality certifies compliance with the European environmental criteria and is only given to products that, compared to those of competitors, have a low environmental impact. Ecolabel is a quality award that identifies and promotes the most eco-friendly products. The environmental criteria evaluate the impact on the entire lifecycle: extraction of raw materials, manufacturing, distribution, use and final disposal.

Il marchio comunitario di qualità ecologica certifica il rispetto di criteri ambientali stabiliti a livello europeo ed è rilasciato esclusivamente a prodotti con un ridotto impatto ambientale rispetto ai concorrenti. Ecolabel è quindi un attestato di eccellenza che segnala e promuove i prodotti più ecologici e rispettosi dell'ambiente. I criteri ambientali valutano l'impatto in tutte le fasi del ciclo di vita: estrazione delle materie prime, processi di lavorazione, distribuzione, utilizzo, smaltimento.

Le label communautaire de qualité écologique certifie le respect de critères environnementaux au niveau européen et n'est délégué qu'aux produits qui ont un impact environnemental réduit par rapport aux concurrents. L'Ecolabel est donc une attestation d'excellence qui signale et promeut les produits les plus écologiques et respectueux de l'environnement. Les critères environnementaux considèrent l'impact pour chaque phase du cycle de vie : extraction des matières premières, processus de fabrication, distribution, utilisation, élimination.

Die Marke ökologischer Qualität der europäischen Gemeinschaft, das europäische Umweltzeichen (Ecolabel), bestätigt die Einhaltung umweltschonender Produktionskriterien, die auf europäischer Ebene vereinbart worden sind, und wird ausschließlich an Produkte, deren Auswirkungen auf die Umwelt im Vergleich zu Mitbewerbern gering sind, verliehen. Ecolabel ist ein Attest für Außergewöhnlichkeit und fördert und unterstützt ökologische und umweltverträgliche Produkte. Die umweltschonende Kriterien gelten in allen Phasen des Lebenszyklus eines Produktes: beim Abbau von Rohstoffen, bei Bearbeitungsprozessen, beim Vertrieb und bei der Entsorgung.

La marca comunitaria de calidad ecológica certifica el respeto de los criterios ambientales establecidos a nivel europeo y es asignada exclusivamente a productos de impacto ambiental reducido respecto a la competencia. Ecolabel es entonces un atestado de excelencia que indica y promueve los productos altamente ecológicos y respetuosos con el ambiente. Los criterios ambientales evalúan el impacto en todas las fases del ciclo de vida: extracción de las materias primas, procesos de elaboración, distribución, uso y eliminación.

Знак экологического качества ЕС удостоверяет соблюдение экологических требований, установленных на европейском уровне, и присваивается товарам, оказывающим меньшее воздействие на окружающую среду, по сравнению с существующими аналогами. Следовательно, Ecolabel является свидетельством безопасности продукции и внимательного отношения производителя к вопросам охраны природы. При выдаче сертификата оценивается воздействие изделий на среду на протяжении всего их жизненного цикла: от добычи сырья и производства до сбыта, эксплуатации и утилизации.

Le label Made in Italy d'Atlas Concorde est synonyme de style, de qualité et d'éthique. Atlas Concorde a adhéré au Code Éthique de Confindustria Ceramica avec conviction et appose le label Made in Italy sur tous les produits étudiés, projetés et fabriqués en Italie : dans ce cas, sur tous les carreaux en céramique, les décorations et la plupart des pièces spéciales. Seul un nombre restreint de ces dernières est fabriqué en Espagne. Les produits Atlas Concorde sont en outre fabriqués avec des technologies qui respectent l'environnement et utilisent des matières premières excellentes et sûres, dans la garantie des meilleurs conditions de travail. Pour ces raisons, le Made in Italy d'Atlas Concorde exprime des valeurs fortes telles que le style, le design, la qualité du produit et le respect de l'environnement et des personnes.

Die Marke Made in Italy von Atlas Concorde ist ein Synonym für Stil, Qualität und Ethik. Aus Überzeugung haben wir uns dem Ethischen Kodex der Confindustria Ceramica (Dachverband der ital. Unternehmen und Unternehmensverbände der Keramikbranche) angeschlossen. Atlas Concorde bringt die Marke Made in Italy auf allen seinen Produkten an die in Italien geplant, entwickelt und realisiert werden, d.h. alle Keramikfliesen, Dekore, Bordüren und der Hauptteil der Spezialteile. Nur eine geringe Anzahl der letzteren werden in Spanien gefertigt. Die Produkte von Atlas Concorde werden darüberhinaus unter Verwendung ausgezeichneter und sicherer Rohstoffe mittels umweltschützender Technologien unter besten Arbeitsbedingungen hergestellt. Aus diesen Gründen ist Made in Italy von Atlas Concorde ein Ausdruck starker Werte wie Stil, Design, Produktqualität.

La marca Made in Italy de Atlas Concorde es sinónimo de estilo, calidad y ética. Adheriendo con convicción el Código Ético de Confindustria Cerámica, Atlas Concorde señala con la marca Made in Italy todos los productos estudiados, diseñados y realizados en Italia, en este caso todas las baldosas de cerámica, las decoraciones y la mayoría de piezas especiales. Sólo un restringido número de estas últimas se fabrica en España. Los productos Atlas Concorde se realizan además con tecnologías que respetan el medio ambiente, usando materias primas excelentes y seguras, garantizando las mejores condiciones de trabajo. Por dichas razones el Made in Italy de Atlas Concorde es la manifestación de valores sólidos como estilo, diseño, calidad del producto, cuidado del medio ambiente y las personas.

Маркировка Made in Italy на плитках Atlas Concorde – синоним стиля, качества и этики. С уверенностью принял «Этический кодекс» федерации Confindustria Ceramica (ассоциация предприятий керамической отрасли), компания отмечает этим знаком все изделия, разработанные и изготовленные в Италии: керамические плитки, декоры и большинство специальных элементов. Лишь ограниченная часть последних производится в Испании. Изделия Atlas Concorde изготовлены с использованием надёжного, высококачественного сырья и передовых технологий, гарантирующих экологическую совместимость производства и оптимальные рабочие условия. Для Atlas Concorde Made in Italy – это выражение важных ценностей, таких как стиль, дизайн, качество. Это уважение к человеку и природе.







CERAMICHE ATLAS CONCORDE S.p.A.  
Via Canaletto 141  
41042 Spezzano di Fiorano (MO) – Italia  
info@atlasconcorde.it

ATLAS CONCORDE USA, INC.  
2830 SW 42 Street  
Hollywood, FL 33312 - U.S.A.

ATLAS CONCORDE RUSSIA  
Business centre "Meliora Place"  
Prospekt Mira 6, 129090 Moscow – Russia  
info@atlasconcordeussia.ru

**[www.atlasconcorde.it](http://www.atlasconcorde.it)**

Copyright 2014 by Ceramiche Atlas Concorde S.p.A.  
(Spezzano di Fiorano, MO - Italy)  
Tipolitografia Pagani  
November 2014