

SERIE DUERO | DUERO SERIES



porcelánico
porcelain



esmaltado
glazed



<1%
máx. 2 mm



$E \leq 0,5\%$



$5,8 \times 10^{-6} \times C^{-1}$



>40N/mm²



Urbión PEI 5
Aranda PEI 4
Porto/Roa PEI 2



Porto: H4
Roa: H6



6 - 8



clase 5
class 5



Deslizam. CTE
Slipping resist. CTE

Urbión/Aranda: clase 3
Porto/Roa: clase 2



Urbión/Aranda C
Roa/Porto B



Urbión/Aranda R10
Roa/Porto R9



sí/yes



Simbología y normas en pág. 187 Symbols and Standards p. 187
Los colores son indicativos Colours are just indicative



Urbión

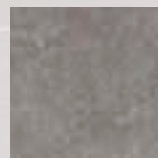

Aranda

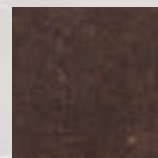

Porto

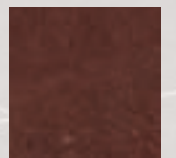

Roa

SERIE DUERO | DUERO SERIES

Bases Basic pieces



Base 30x60
Tile 30x60

Urbión ■ Aranda ■
Cod. 03351 Cod. 03350
Porto ■ Roa ■
Cod. 03352 Cod. 02460



Base 30x30
Tile 30x30

Urbión ■ Aranda ■
Cod. 03378 Cod. 03366
Porto ■ Roa ■
Cod. 03390 Cod. 02462

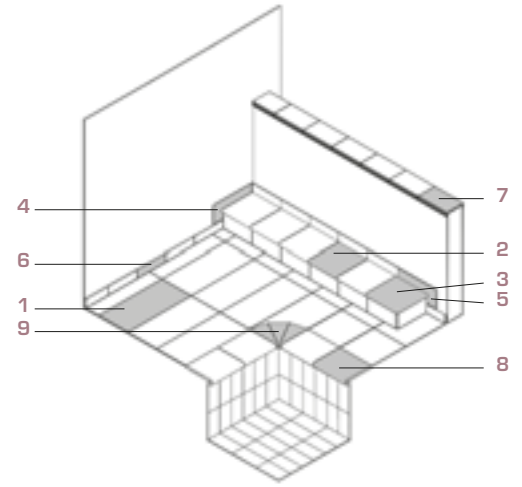
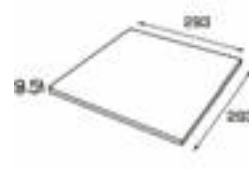

- | | |
|----------------------------|---------------------|
| 1 Base | Tile |
| 2 Peldaño | Stair-tread |
| 3 Esquina de peldaño | Stair-tread corner |
| 4 Zanquín izda. | String left |
| 5 Zanquín dcha. | String right |
| 6 Rodapié | Skirting board |
| 7 Pasamanos | Handrail |
| 8 Remate | Edge |
| 9 Esq. interior remate R50 | Internal corner R50 |



Base 15x60
Tile 15x60

Urbión ■ Aranda ■
Cod. 03376 Cod. 03364
Porto ■ Roa ■
Cod. 03388 Cod. 02461

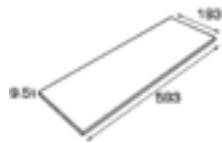

Base 15x30
Tile 15x30

Urbión ■ Aranda ■
Cod. 03377 Cod. 03365
Porto ■ Roa ■
Cod. 03389 Cod. 02463



Base 15x15
Tile 15x15

Urbión ■ Aranda ■
Cod. 03379 Cod. 03367
Porto ■ Roa ■
Cod. 03391 Cod. 02464

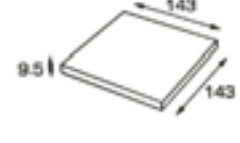

Artículo Item	Medidas (mm) Size (mm)	Espesor (mm) Thickness (mm)	U.M.*	U.M.*		Piezas Pieces		Peso (Kg) Weight (Kg)		
				U.M.*	U.M.*	U.M.*	U.M.*	U.M.*	U.M.*	
Base 30x30 Tile 30x30	293x293	9,5	M² SQM	0,99	71,29	11,11	11	20,2	20	1440
Base 30x60 Tile 30x60	293x593	9,5	M² SQM	1,08	64,86	5,55	6	20,17	21,78	1310
Base 15x15 (•) Tile 15x15 (•)	143x143	9,5	M² SQM	0,99	71,29	44,44	44	19,1	18,90	1361,44
Base 15x30 (•) Tile 15x30 (•)	143x293	9,5	M² SQM	0,99	71,29	22,22	22	19,9	19,70	1418,67
Base 15x60 (•) Tile 15x60 (•)	143x593	9,5	M² SQM	1,08	34,56	11,11	12	19,9	21,49	687,74

*Unidad de Medida. Los artículos medidos en M² o ML se sirven contando la junta normal entre piezas
*Unit of measure. Items measured in SQM or LM are delivered assuming average joint between pieces

(•) Disponible bajo pedido
(•) Available on request

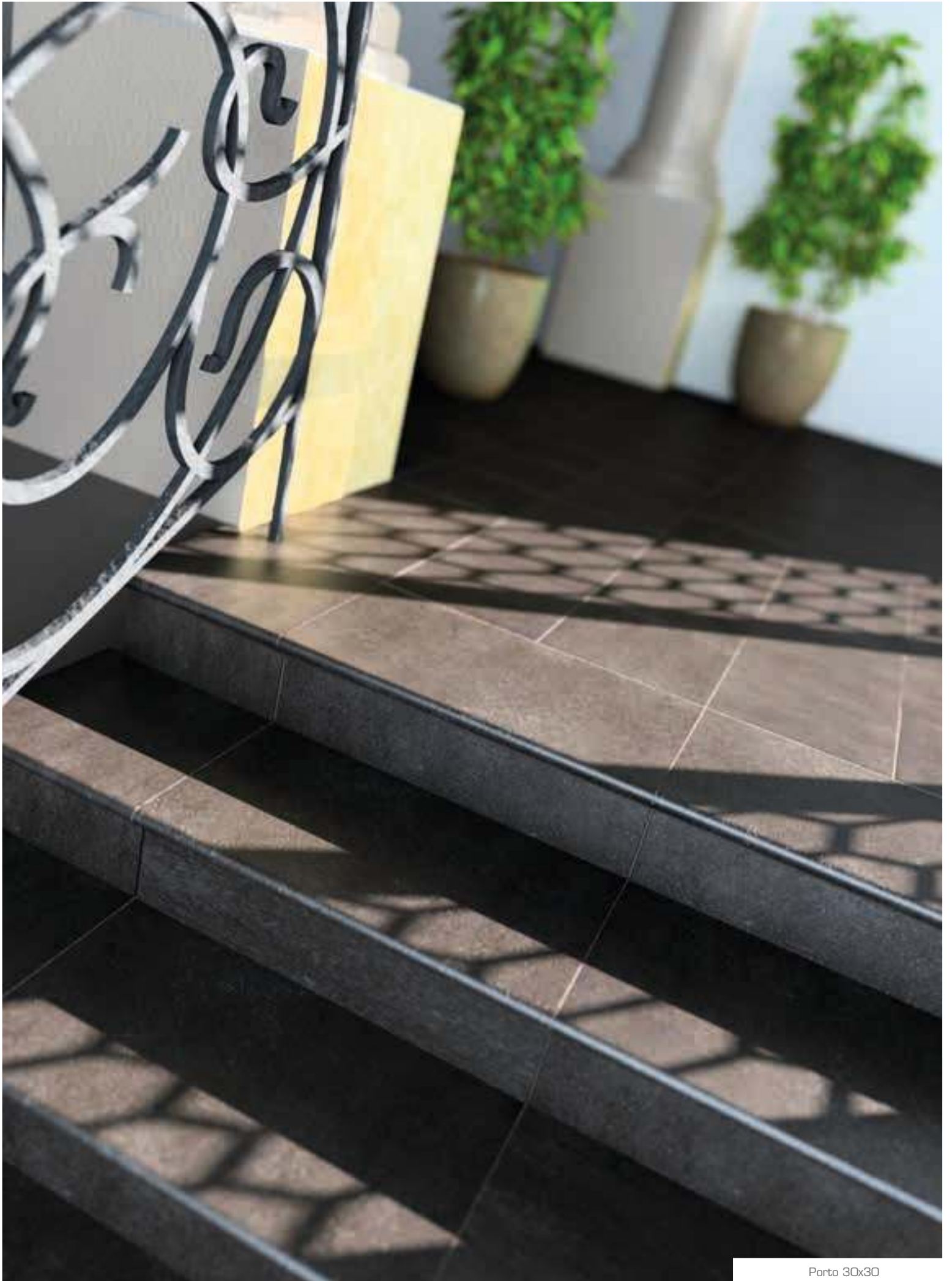

Porto 30x30

Peldaño
Stair-tread

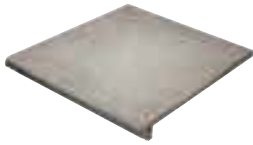

Urbión ■	Aranda ■
Cod. 03354	Cod. 03353
Porto ■	Roa ■
Cod. 03355	Cod. 02465

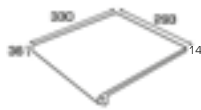

Peldaño 60
Stair-tread 60



Urbión ■	Aranda ■
Cod. 02702	Cod. 02703
Porto ■	Roa ■
Cod. 02704	Cod. 02701



Esquina de peldaño
Stair-tread corner



Urbión ■	Aranda ■
Cod. 03381	Cod. 03369
Porto ■	Roa ■
Cod. 03393	Cod. 02469



Pasamanos 15,5
Handrail 15,5



Urbión ■	Aranda ■
Cod. 03380	Cod. 03368
Porto ■	Roa ■
Cod. 03392	Cod. 02470

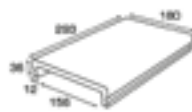

Zanquín izda.
String left side



Urbión ■	Aranda ■
Cod. 03383	Cod. 03371
Porto ■	Roa ■
Cod. 03395	Cod. 02466



Zanquín dcha.
String right side



Urbión ■	Aranda ■
Cod. 03384	Cod. 03372
Porto ■	Roa ■
Cod. 03396	Cod. 02467



Rodapié
Skirting board

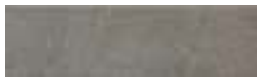

Urbión ■	Aranda ■
Cod. 03382	Cod. 03370
Porto ■	Roa ■
Cod. 03394	Cod. 02468



Remate
Edge



Urbión ■	Aranda ■
Cod. 03385	Cod. 03373
Porto ■	Roa ■
Cod. 03397	Cod. 02471



Esq. int. remate R250
Internal corner R250



Urbión ■	Aranda ■
Cod. 02505	Cod. 02506
Porto ■	Roa ■
Cod. 02507	Cod. 02508



Esq. ext. remate
External corner



Urbión ■ Aranda ■
Cod. 03387 Cod. 03375
Porto ■ Roa ■
Cod. 03399 Cod. 02473



Esq. int. remate R50
Internal corner R50



Urbión ■ Aranda ■
Cod. 03386 Cod. 03374
Porto ■ Roa ■
Cod. 03398 Cod. 02472

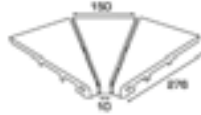

Peldaño/Vierteaguas
Stair-tread/Wash



Urbión ■ Aranda ■
Cod. 01552 Cod. 01551
Porto ■ Roa ■
Cod. 01553 Cod. 01554

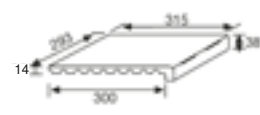

Artículo Item	Medidas (mm) Size (mm)	Espesor (mm) Thickness (mm)	U.M.*	U.M.*		Piezas Pieces		Peso (Kg) Weight (Kg)		
						U.M.*		U.M.*		
Peldaño Stair-tread	293x330	14	Pz. Pc.	6	378	1	6	2,83	17	1070
Peldaño 60 Stair-tread 60	593x330	14	Pz. Pc.	4	72	1	4	5,72	22,91	412,4
Esquina de peldaño Stair-tread corner	330x330	14	Pz. Pc.	2	84	1	2	2,5	5	225
Zanquín izda. String left	395x80/170	9,5	Pz. Pc.	20	540	1	20	0,81	16,2	453
Zanquín dcha. String right	395x80/170	9,5	Pz. Pc.	20	540	1	20	0,81	16,2	453
Rodapié Skirting board	293x80	9,5	ML LM	10,21	367,57	3,33	34	1,73	17,6	650
Pasamanos 15,5 Handrail 15,5	293x180x36	12	Pz. Pc.	4	288	1	4	1,63	6,5	485
Remate Edge	293x275x36	15	Pz. Pc.	4	288	1	4	3,3	13	962
Esq. ext. remate External corner	276x276	15	Set Set	2	—	3	6	2,31	4,6	—
Esq. int. remate R50 Internal corner R50	276x276	15	Set Set	2	—	3	6	3,30	6,60	—
Esq. int. remate R250 Internal corner R250	276x276	15	Set Set	1	—	3	3	5,7	5,7	—
Peldaño/Vierteaguas Stair-tread/Wash	293x315x38	14	Pz. Pc.	8	252	1	8	2,71	21,68	725

* Unidad de Medida. Los artículos medidos en M² o ML se sirven contando la junta normal entre piezas
* Unit of measure. Items measured in SQM or LM are delivered assuming average joint between pieces

Piezas especiales Special pieces

Borde desbordante 60 cm.
Overflowing edge 60 cm.



Urbión ■ Aranda ■
Cod. 02122 Cod. 02123

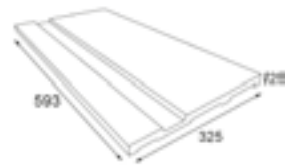

Rejilla cerámica
Ceramic grid



Urbión ■ Aranda ■
Cod. 02126 Cod. 02127

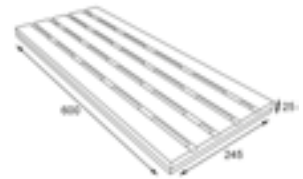

Canaleta*
Overflow channel



Urbión ■ Aranda ■
Cod. 02130 Cod. 02131

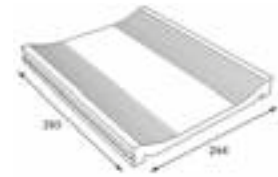

* Disponible Canaleta con desagüe
* Available Overflow channel with drainage

Esq. int. borde desbordante
Overflowing internal edge



Urbión ■ Aranda ■
Cod. 02134 Cod. 02136

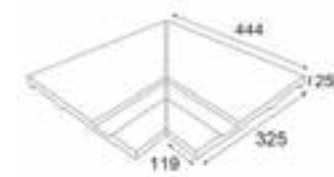

Esq. ext. borde desbordante
Overflowing external edge



Urbión ■ Aranda ■
Cod. 02135 Cod. 02137

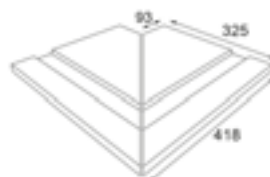

Esq. int./ext. rejilla cerámica
Internal/external corner ceramic grid





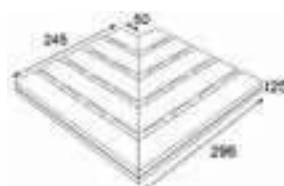
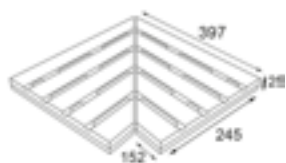



Urbión ■ Aranda ■
Cod. 02142 Cod. 02144



Anchura recomendada de la junta de colocación: 6 - 8 mm
A 6 - 8 mm wide installation joint is recommended.



Aranda

Artículo Item	Medidas (mm) Size (mm)	Espesor (mm) Thickness (mm)	U.M.*	U.M.*		Piezas Pieces		Peso (Kg) Weight (Kg)		
						U.M.* 		U.M.* 		
Borde desbordante 60 cm. <i>Overflowing edge 60 cm.</i>	593x325	25	Pz. Pc.	4	72	1	4	7,5	30	555
Rejilla cerámica <i>Ceramic grid</i>	600x245	25	Pz. Pc.	3	243	1	3	6,15	18,45	1509,45
Esq. int. borde desbordante <i>Overflowing internal edge</i>	444x325x119	25	Jg. Set	2	—	2	4	7	14	—
Esq. ext. borde desbordante <i>Overflowing external edge</i>	418x325x93	25	Jg. Set	2	—	2	4	7	14	—
Esq. int./ext. rejilla cerámica <i>Internal/external corner ceramic grid</i>	397x245x152	25	Jg. Set	2	—	2	4	5,5	11	—
Canaleta <i>Overflow channel</i>	293x244	—	Pz. Pc.	4	288	1	4	2,5	9,99	734

* Unidad de Medida. Los artículos medidos en M² o ML se sirven contando la junta normal entre piezas
 *Unit of measure. Items measured in SQM or LM are delivered assuming average joint between pieces