

ÍNDICE/INDEX

Serie RAINFOREST	2
Serie SEA ROCK	8
Serie SYMBOLS	14
Serie ONE	20
Serie NATURA	24
Serie BORRIOL	28
Serie PEDRA	32
Serie PORTO	36
Serie CASTILLA	40
Serie VALLE	46
Serie POMPEI	50

RAINFOREST

Mayo
CERÁMICA

Gres porcelánico



Blanco



Musgo



Ceniza

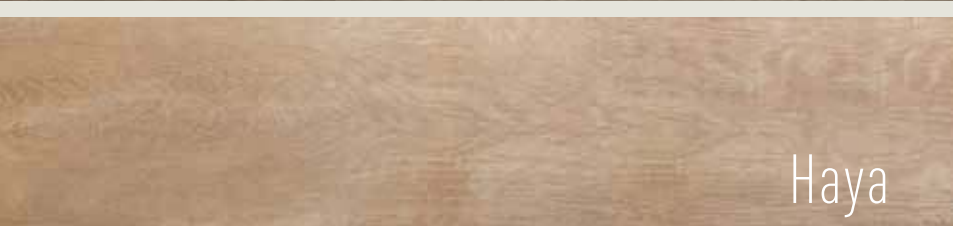

Haya



Roble



Nogal

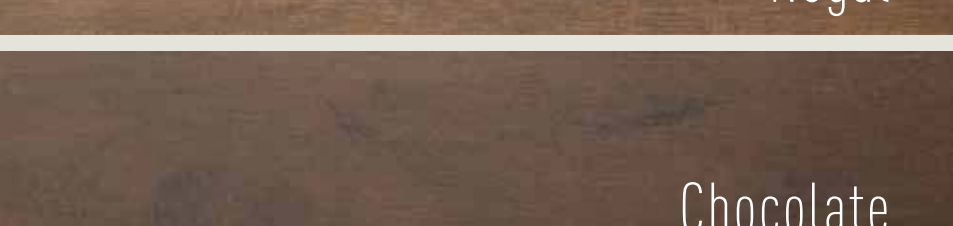

Chocolate

RAINFOREST

ATMÓSFERA NATURAL
NATURAL ATMOSPHERE / ATMOSPHÈRE NATURELLE

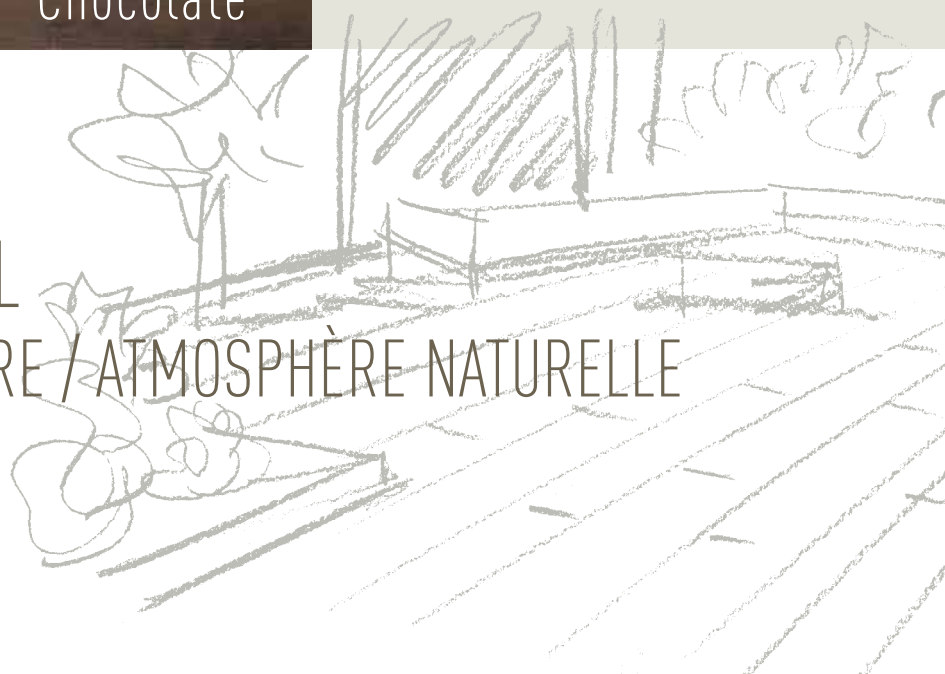





La calidez y el tacto de la madera, con las características del mejor gres, en una colección luminosa que ofrece grandes formatos. Su colocación tanto en interiores como exteriores da continuidad a los espacios y crea una atmósfera natural.

The warmth and touch of the wood with the characteristics of the best stoneware, in a bright collection which offers large formats. Its installation both indoors and outdoors gives continuity to the areas and creates a natural atmosphere.

La chaleur et le toucher du bois, avec les caractéristiques du meilleur grès, dans une collection lumineuse offrant de grands formats. Sa pose, aussi bien en intérieur qu'à l'extérieur, donne de la continuité aux espaces tout en créant une atmosphère naturelle.

PACKING LIST

	pzas/caja pieces/box pièces/boîte	m ² /caja SQM/box m ² /boîte	cajas/palet boxes/pallet boîtes/palette	pzas/palet pieces/pallet pièces/palette	m ² /palet SQM/pallet m ² /palette	Kg/palet (aprox) Kg/pallet Kg/palette
BASES						
Base 21x150 cm - 8.2"x59"	4	1,26	54	216	68,04	1.742,00
Base 21x120 cm - 8.2"x47.2"	4	1,00	54	216	54,00	1.393,00
Base 21x75 cm - 8.2"x29.5"	6	0,94	56	336	52,64	1.390,00
Base 31,6x31,6* cm - 12.4"x12.4"	10	1.00	60	600	60,00	1.272,00

	pzas/caja pieces/box pièces/boîte	cajas/palet boxes/pallet boîtes/palette	pzas/palet pieces/pallet pièces/palette	Kg/caja Kg/box Kg/boîte	Kg/palet (aprox) Kg/pallet Kg/palette
PIEZAS ESPECIALES					
Rodapié 9x31,6 cm - 3.5"x12.4"	22	99	2.178	13,20	1.306,80
Peldaño recto 31,6x33 cm -12.4"x12.9"	6	66	396	16,00	1.049,40
Peldaño recto 33x63 cm -12.9"x24.8"	4	66	264	20,00	1.301,00
Peldaño ang. recto 33x33 cm -12.9"x12.9"	1	116	116	2,78	322,48
Peldaño florentino 31,6x33 cm -12.4"x12.9"	6	66	396	17,70	1.168,20
Peldaño florentino 33x63 cm -12.9"x24.8"	4	66	264	19,72	1.301,52
Peldaño ang. florentino 33x33 cm -12.9"x12.9"	1	116	116	2,80	324,80
Peldaño completo 120x33 cm - 47.2"x12.9"	1				
Zanquín 9x30 cm - 3.5"x11.8"	22	99	2.178	13,20	1.306,80

CARACTERÍSTICAS TÉCNICAS TECHNICAL CHARACTERISTICS_CARACTÉRISTIQUES TECHNIQUES

			
Resistencia a la abrasión Friction resistance Résistance à l'abrasion	Resistencia a la helada Frost resistance Résistance au gel	Resistencia al choque térmico Thermal shock resistance Résistance aux chocs thermiques	Resistencia a la flexión Modulus of rupture Résistance à la flexion
II-IV	✓	✓	>23N / mm²
			
Antideslizante Slip resistance Résistance au glissement	Resistencia a las manchas Stain resistance Résistance aux tâches	Resistencia al rayado Scratch resistance Résistance à la rayure	Absorción de agua Water absorption Absorption d'eau
2	5	9	< 0,5 %

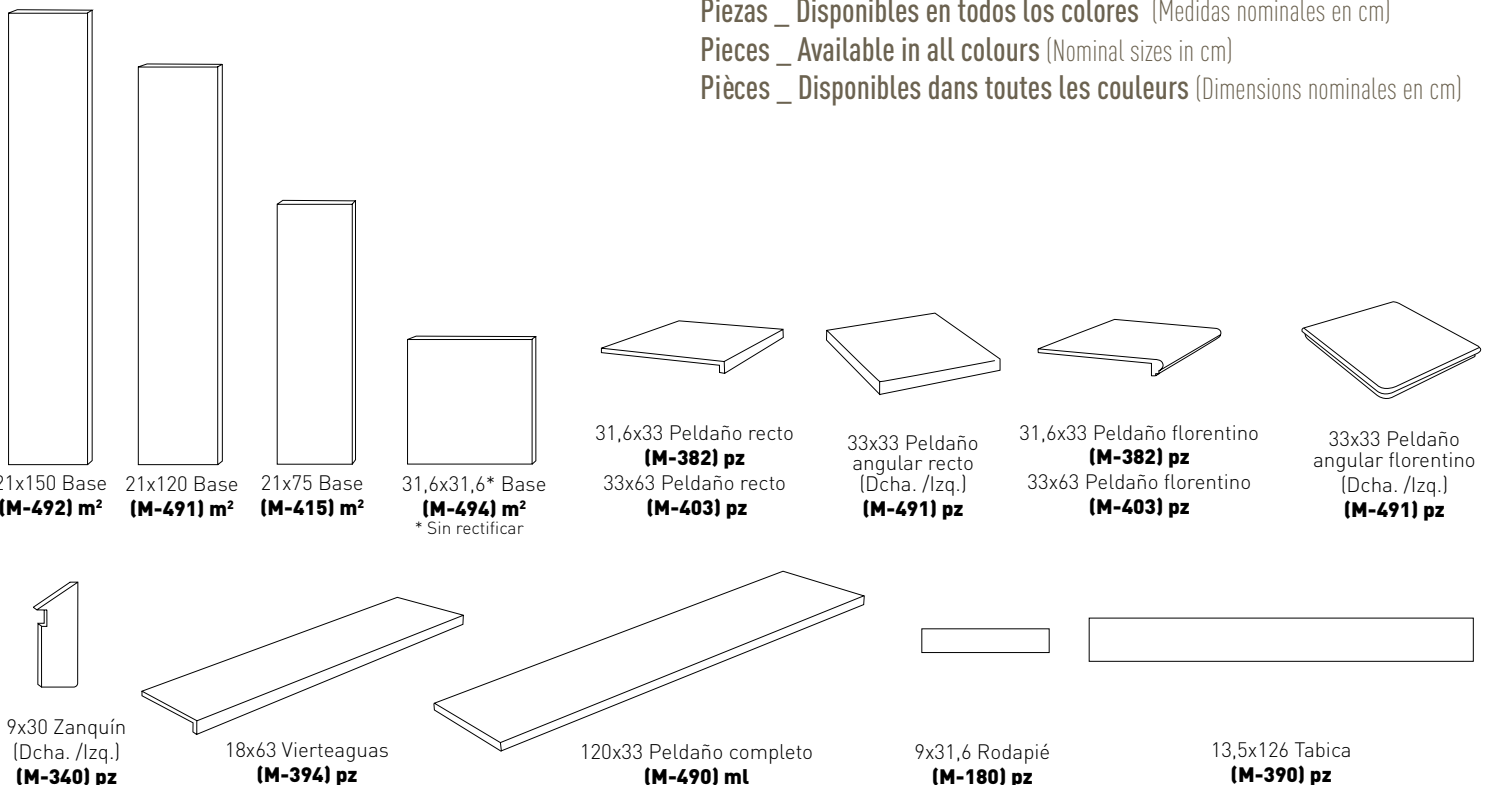



Mayor
CERÁMICA

CERÁMICA MAYOR S.A.
Partida Planet, s/n
03510 Callosa d'En Sarrià
(Alicante-España)
T+34 965 881 175
F+34 965 881 919
www.ceramicamayor.com





Sea Rock

Mayo
CERÁMICA

Gres porcelánico



Marfil



Caramel



Toffee



Terra



Visón



Gris Oscuro

Sea Rock

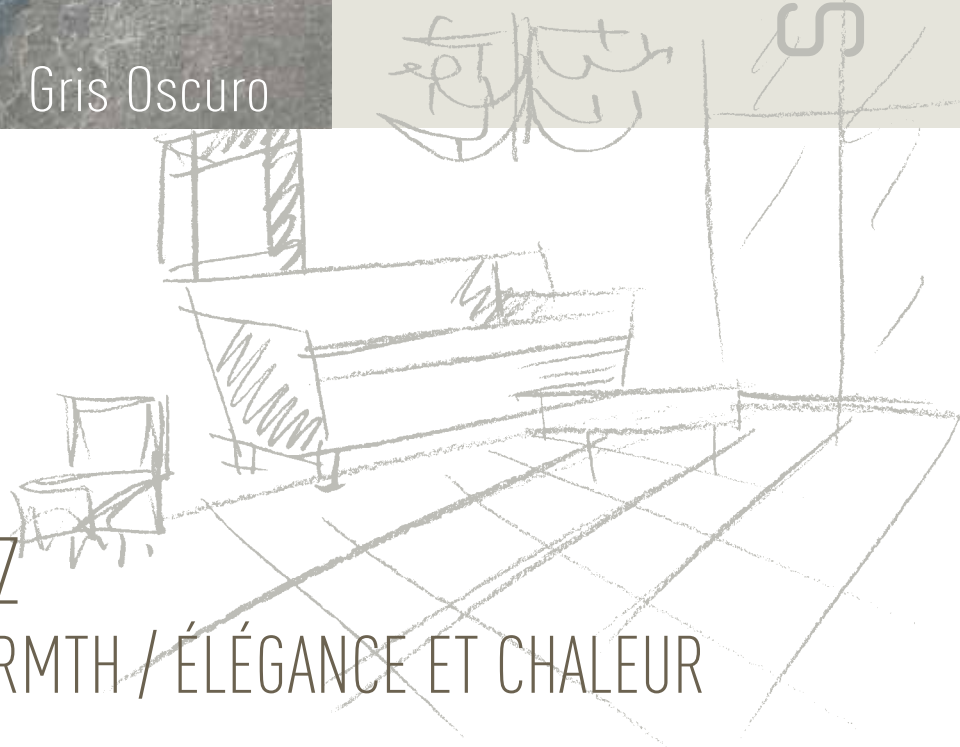

ELEGANCIA Y CALIDEZ

ELEGANCE AND WARMTH / ÉLÉGANCE ET CHALEUR





Esta colección de gres inspirada en las rocas, destaca por su acertada paleta de colores y la perfecta reproducción de las vetas de los mármoles más exquisitos. Una textura, unas tonalidades y un brillo natural inspiran la creación de ambientes de estilo clásico, moderno o funcional.

This stoneware collection inspired by the rocks, is outstanding for its suitable colour pallet and the perfect reproduction of the veining of the most exquisite marbles. A perfect texture, tone and natural shine that inspires the creation of classic, modern and functional styles.

Cette collection de grès, inspirée dans les rochers, se distingue pour sa judicieuse palette de couleurs et la reproduction parfaite des veines des marbres les plus prestigieux. Une texture, des teintes et un éclat naturel qui inspirent la création d'ambiances dans un style classique, moderne ou fonctionnel.

PACKING LIST

BASES

	pzas/caja pieces/box pièces/boîte	m ² /caja SQM/box m ² /boîte	cajas/palet boxes/pallet boîtes/palette	pzas/palet pieces/pallet pièces/palette	m ² /palet SQM/pallet m ² /palette	Kg/palet (aprox) Kg/pallet Kg/palette
Base 43x120 cm - 16.9"x47.2"	2	1,03	48	96	49,44	1.038,00
Base 43x75 cm - 16.9"x29.5"	3	0,97	48	144	46,56	975,00
Base 31,6x31,6* cm - 12.4"x12.4"	10	1,00	60	600	60,00	1.272,00

PIEZAS ESPECIALES

	pzas/caja pieces/box pièces/boîte	cajas/palet boxes/pallet boîtes/palette	pzas/palet pieces/pallet pièces/palette	Kg/caja Kg/box Kg/boîte	Kg/palet (aprox) Kg/pallet Kg/palette
Rodapié 9x31,6 cm - 3.5"x12.4"	22	99	2.178	13,20	1.306,80
Peldaño recto 31,6x33 cm - 12.4"x12.9"	6	66	396	16,00	1.049,40
Peldaño recto 33x63 cm - 12.9"x24.8"	4	66	264	20,00	1.301,00
Peldaño ang. recto 33x33 cm - 12.9"x12.9"	1	116	116	2,78	322,48
Peldaño florentino 31,6x33 cm - 12.4"x12.9"	6	66	396	17,70	1.168,20
Peldaño florentino 33x63 cm - 12.9"x24.8"	4	66	264	19,72	1.301,52
Peldaño ang. florentino 33x33 cm - 12.9"x12.9"	1	116	116	2,80	324,80
Peldaño completo 120x33 cm - 47.2"x12.9"	1				
Zanquín 9x30 cm - 3.5"x11.8"	22	99	2.178	13,20	1.306,80

CARACTERÍSTICAS TÉCNICAS

TECHNICAL CHARACTERISTICS_CARACTÉRISTIQUES TECHNIQUES



Resistencia a la abrasión
Friction resistance
Résistance à l'abrasion

II-IV



Resistencia a la helada
Frost resistance
Résistance au gel



Resistencia al choque térmico
Thermal shock resistance
Résistance aux chocs thermiques



Resistencia a la flexión
Modulus of rupture
Résistance à la flexion

>23N / mm²



Antideslizante
Slip resistance
Résistance au glissement

2



Resistencia a las manchas
Stain resistance
Résistance aux tâches

5



Resistencia al rayado
Scratch resistance
Résistance à la rayure

9



Absorción de agua
Water absorption
Absorption d'eau

<0,5 %

Piezas _ Disponibles en todos los colores (Medidas nominales en cm)

Pieces _ Available in all colours (Nominal sizes in cm)

Pièces _ Disponibles dans toutes les couleurs (Dimensions nominales en cm)

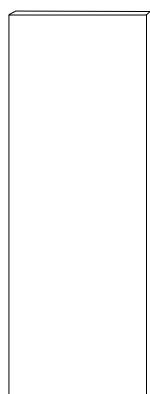

43x120 Base
(M-491) m²

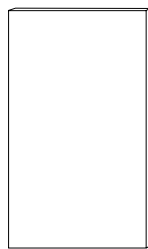

43x75 Base
(M-415) m²

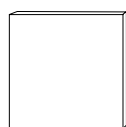

31,6x31,6* Base
(M-494) m²
* Sin rectificar



31,6x33 Peldaño recto
(M-382) pz
33x63 Peldaño recto
(M-403) pz

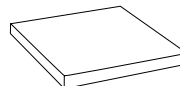

33x33 Peldaño
angular recto
(M-491) pz

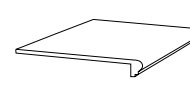

31,6x33 Peldaño florentino
(M-382) pz
33x63 Peldaño florentino
(M-403) pz

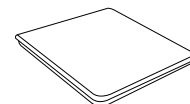

33x33 Peldaño
angular florentino
(M-491) pz



9x30 Zanquín
(Dcha. /Izq.)
(M-340) pz

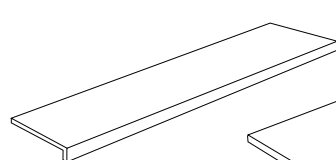

18x63 Vierteaguas
(M-394) pz

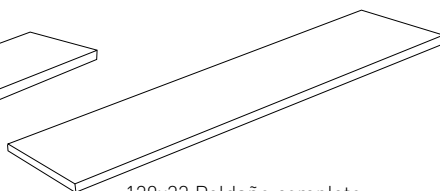

120x33 Peldaño completo
(M-490) ml

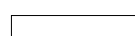

9x31,6 Rodapié
(M-180) pz



13,5x126 Tabica
(M-390) pz

Mayor
CERÁMICA

CERÁMICA MAYOR S.A.
Partida Planet, s/n
03510 Callosa d'En Sarrià
(Alicante-España)
T+34 965 881 175
F+34 965 881 919
www.ceramicamayor.com



SYMBOLS

Mayor
CERÁMICA

Gres porcelánico



Beta



Gamma



Alfa



Omega



Delta

SYMBOLS

SENCILLEZ Y NATURALIDAD

PLAIN AND NATURAL
SIMPLICITÉ ET NATUREL







Sencillez y naturalidad en una piedra cerámica. Estas son las señas de identidad de estas piezas, fruto de la investigación y desarrollo en el proceso de producción de nuestros productos de gres. La neutralidad cromática de esta colección es un reflejo de las nuevas tendencias en arquitectura.

Plain and natural is a ceramic stone. These are the marks of identity for these pieces, fruit of the research and development in the production process of our stoneware products. The neutral colours of this collection are a reflection of the latest trends in architecture.

La simplicité et le naturel d'une pierre céramique. Voilà les signes d'identité de ces pièces, fruit de la recherche et du développement dans le processus de production de nos produits en grès. La neutralité chromatique de cette collection est un reflet des nouvelles tendances en architecture.

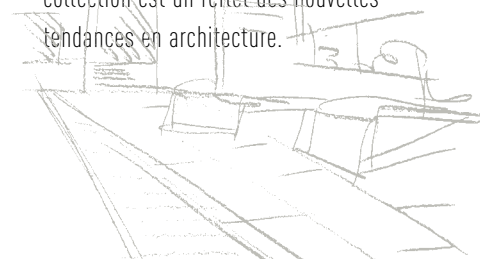

PACKING LIST

	pzas/caja pieces/box pièces/boîte	m ² /caja SQM/box m ² /boîte	cajas/palet boxes/pallet boîtes/palette	pzas/palet pieces/pallet pièces/palette	m ² /palet SQM/pallet m ² /palette	Kg/palet (aprox) Kg/pallet Kg/palette
BASES Base 31,6x63 cm - 12.4"x24.8"	5	1,00	48	240	48,00	1.032,00

PIEZAS ESPECIALES

	pzas/caja pieces/box pièces/boîte	cajas/palet boxes/pallet boîtes/palette	pzas/palet pieces/pallet pièces/palette	Kg/caja Kg/box Kg/boîte	Kg/palet (aprox) Kg/pallet Kg/palette
Rodapié 9x31,6cm - 3.5"x12.4"	22	99	2.178	13,20	1.306,80
Peldaño recto 31,6x33cm - 12.4"x12.9"	6	66	396	16,00	1.168,20
Peldaño ang. recto 33x33cm - 12.9"x12.9"	1	116	116	2,78	322,48

CARACTERÍSTICAS TÉCNICAS

TECHNICAL CHARACTERISTICS _ CARACTÉRISTIQUES TECHNIQUES



Resistencia a la abrasión
Friction resistance
Résistance à l'abrasion

II-IV



Resistencia a la helada
Frost resistance
Résistance au gel



Resistencia al choque térmico
Thermal shock resistance
Résistance aux chocs thermiques



Resistencia a la flexión
Modulus of rupture
Résistance à la flexion

>23N / mm²



Antideslizante
Slip resistance
Résistance au glissement

2



Resistencia a las manchas
Stain resistance
Résistance aux tâches

5



Resistencia al rayado
Scratch resistance
Résistance à la rayure

8



Absorción de agua
Water absorption
Absorption d'eau

< 0,5 %

Piezas _ Disponibles en todos los colores (Medidas nominales en cm)

Pieces _ Available in all colours (Nominal sizes in cm)

Pièces _ Disponibles dans toutes les couleurs (Dimensions nominales en cm)



31,6x63 Base
(M-405) m²



9x31,6 Rodapié
(M-170) pz



31,6x33 Peldaño recto
(M-345) pz

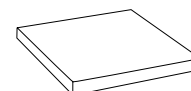

33x33 Peldaño angular recto
(M-490) pz

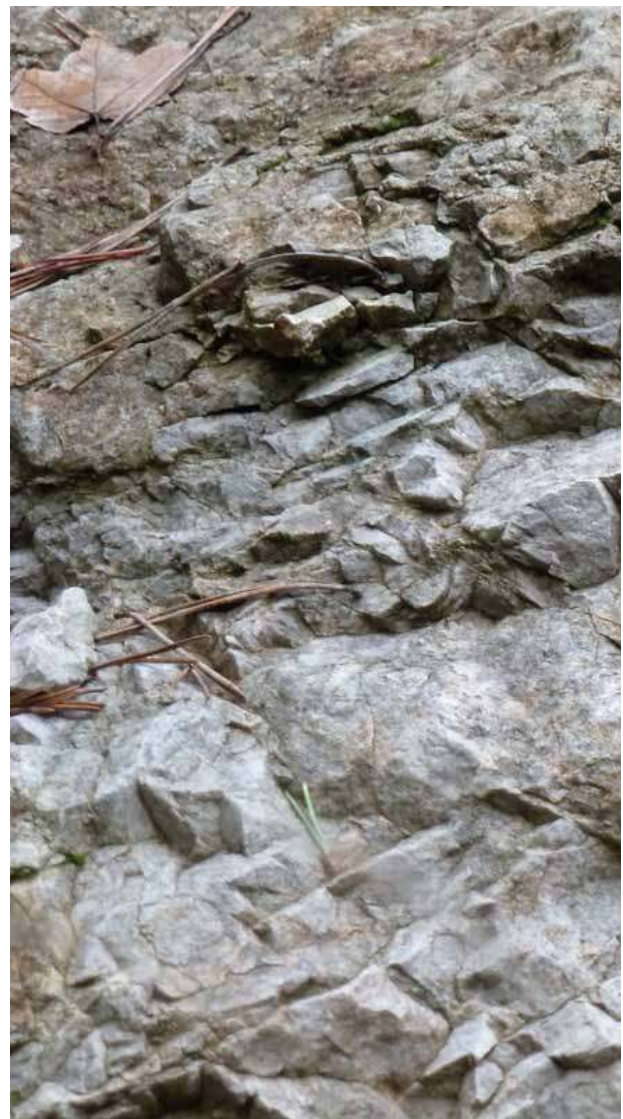

Mayor
CERÁMICA

CERÁMICA MAYOR S.A.
Partida Planet, s/n
03510 Callosa d'En Sarrià
(Alicante-España)
T+34 965 881 175
F+34 965 881 919
www.ceramicamayor.com



CERÁMICA MAYOR

SERIE
ONE

Gres
porcelánico
extrusionado



SERIE ONE

Gres Porcelánico Extrusionado

Bases_ Medidas nominales



Agatha

25x25 **(M-388)m²**
31,6x31,6 **(M-391)m²**



Citrine

25x25 **(M-388)m²**
31,6x31,6 **(M-391)m²**

Piezas especiales_ Disponibles en todos los colores



25x33 PELD. FLORENTINO **(M-310)**
31,6x33 PELD. FLORENTINO **(M-330)**



33x33 PELD. ANGULAR FLORENTINO **(M-490)**



16x25 VIERTEAGUAS **(M-260)**



9x25 RODAPIÉ **(M-153)**
9x31,6 RODAPIÉ **(M-170)**

BASES	Medidas	Piezas/Caja	m ² /Caja	Cajas/Palet	Piezas/Palet	m ² /Palet	Kgs/Palet (aprox)
	25x25 cm - 9,8"x9,8"	16	1,00	75	1.200	75,00	1.455
	31,6x31,6 cm - 12,4"x12,4"	10	1,00	60	600	60,00	1.260
PIEZAS ESPECIALES	Medidas	Piezas/Caja	Cajas/Palet	Piezas/Palet	kgs/Caja	Kgs/Palet (aprox)	
	RODAPIÉ 9x25 cm - 3,5"x9,8"	28	99	2.772	13,64	1.350	
	RODAPIÉ 9x31,6 cm - 3,5"x12,4"	22	99	2.178	12,76	1.263	
	PELDAÑO 25x33 cm - 9,8"x13"	6	88	528	14,59	1.284	
	PELDAÑO 31,6x33 cm - 12,4"x13"	6	66	396	17,90	1.181	
	PELDAÑO ANGULAR 33x33 cm -13"x13"	4	48	192	12,96	622	
	VIERTEAGUAS 16x25 cm - 6,3"x9,8"	10	96	960	11,68	1.121	



SERIE ONE

Medidas nominales en cm.

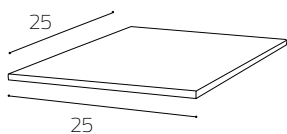

Base 25

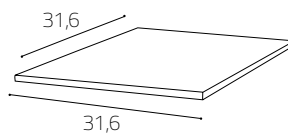

Base 31

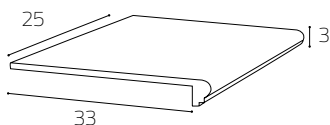

Peldaño florentino 25

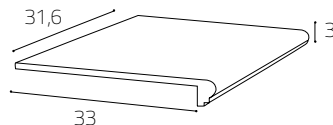

Peldaño florentino 31

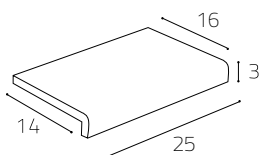

Vierteaguas

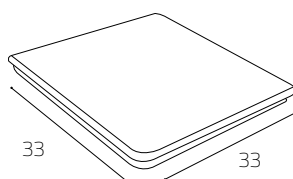

Peldaño angular florentino

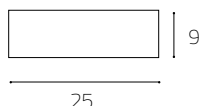

Rodapié 25



Rodapié 31

Características Técnicas - Serie ONE



Resistencia a la abrasión

I



Resistencia a la helada

Resiste



Resistencia al choque térmico

Resiste



Resistencia a la flexión

>23N / mm²



Antideslizante

Clase 2



Resistencia a las manchas

Clase 5



Resistencia al rayado

6



Absorción de agua

< 0,5%



CERÁMICA MAYOR S.A.

Partida Planet, s/n 03510 Callosa d'En Sarrià (Alicante-España)
T+34 965 881 175 - F+34 965 881 919 - www.ceramicamayor.com

Mayor
CERÁMICA

CERÁMICA MAYOR

SERIE Gres
porcelánico
extrusionado
NATURA



SERIE NATURA

Gres porcelánico extrusionado

Bases_ Medidas nominales



Aitana

25x25 **(M-390)m²**

31,6x31,6 **(M-392)m²**



Sarriá

25x25 **(M-390)m²**

31,6x31,6 **(M-392)m²**

Piezas especiales_ Disponibles en todos los colores



25x33 PELDAÑO CURVO **(M-310)**

31,6x33 PELDAÑO CURVO **(M-330)**



33x33 PELDAÑO CURVO ANGULAR CORTE

(M-392)



25x26,5 VIERTEAGUAS

(M-260)



31,6x25 BORDE PISCINA **(M-350)**



9x25 RODAPIÉ **(M-153)**

9x31,6 RODAPIÉ **(M-170)**



PASAMANOS FLORENTINO 12* **(M-310)**

PASAMANOS FLORENTINO 15* **(M-310)**

PASAMANOS FLORENTINO 20* **(M-310)**

* medidas interiores



31,6x25 ÁNGULO INT. BORDE PISCINA **(M-417)**



25x25 ÁNGULO EXT. BORDE PISCINA **(M-417)**



ZANQUÍN DCHO/IZDO CURVO

(M-340)



120x33 PELDAÑO CURVO

(M-419)



BASES	Medidas	Piezas/Caja	m ² /Caja	Cajas/Palet	Piezas/Palet	m ² /Palet	Kgs/Palet (aprox)
	25x25 cm - 9,8"x9,8"	16	1,00	75	1,200	75,00	1.400
	31,6x31,6 cm - 12,4"x12,4"	10	1,00	60	600	60,00	1.300
PIEZAS ESPECIALES	Medidas	Piezas/Caja	Cajas/Palet	Piezas/Palet	kgs/Caja	Kgs/Palet (aprox)	
	RODAPIÉ 9x25 cm - 3,5"x9,8"	28	99	2,772	13,64	1.350	
	RODAPIÉ 9x31,6 cm - 3,5"x12,4"	22	99	2,178	12,96	1.283	
	PELDAÑO 25x33 cm - 9,8"x13"	6	80	480	12,03	962	
	PELDAÑO 31,6x33 cm - 12,4"x13"	6	60	360	19,68	1.181	
	PELDAÑO 120x33 cm - 46,8"x13"	1	75	75	21,60	1.620	
	PELDAÑO ANG. CORTE 33x33 cm - 13"x13"	4	48	192	12,96	622	
	ZANQUÍN DCHO.-IZDO.	10	80	800	10,38	830	
	VIERTEAGUAS 25x26,5 cm - 9,8"x10,4"	10	100	1,000	15,83	1.583	
	PASAMANOS 12x25 cm - 4,7"x9,8"	6	108	648	8,61	930	
	PASAMANOS 15x25 cm - 5,9"x9,8"	6	96	576	9,32	895	
	PASAMANOS 20x25 cm - 7,8"x9,8"	6	80	480	11,25	900	
	BORDE PISCINA 31,6x25 cm - 12,4"x9,8"	4	66	264	16,41	1.083	
	ANG. INT. BORDE PISC. 31,6x25 cm - 12,4"x9,8"	4					
	ANG. EXT. BORDE PISC. 25x25 cm - 9,8"x9,8"	4					

SERIE NATURA

Medidas nominales en cm.

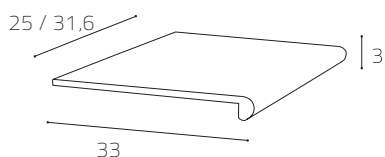

Peldaños curvos

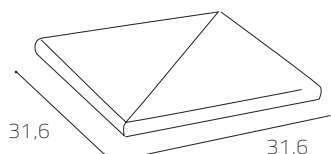

Peldaño curvo angular corte

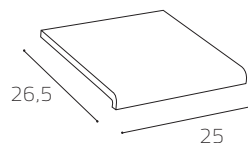

Vierteaguas

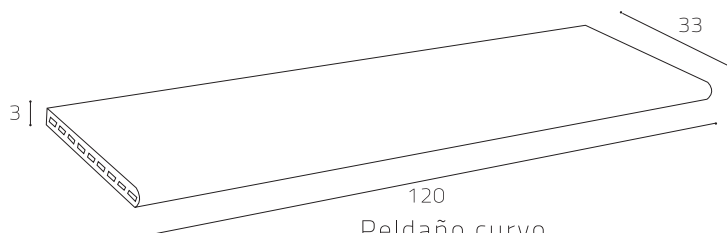

Peldaño curvo

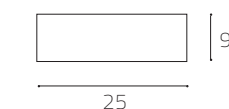

Rodapié

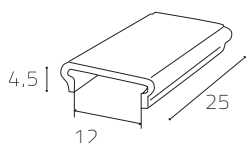

Pasamanos florentino 12

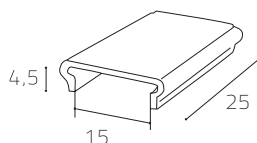

Pasamanos florentino 15

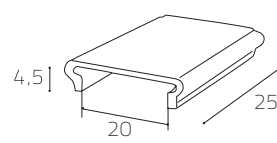

Pasamanos florentino 20

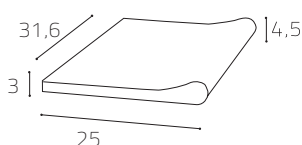

Borde piscina

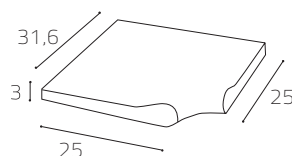

Ángulo int. borde piscina

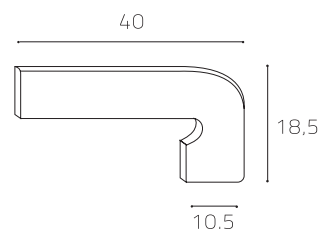

Zanquín
dcho. / izq. curvo

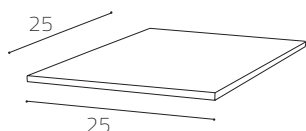

Base

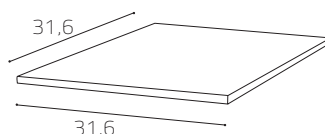

Base

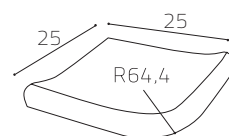

Borde exterior piscina

Características Técnicas - Serie NATURA



Resistencia
a la abrasión

III



Resistencia
a las heladas

Resiste



Resistencia
al choque térmico

Resiste



Resistencia
a la flexión

>23N / mm²



Antideslizante

Clase 3



Resistencia
a las manchas

Clase 5



Resistencia
al rayado

8



Absorción
de agua

< 0,5%



CERÁMICA MAYOR S.A.

Partida Planet, s/n 03510 Callosa d'En Sarrià (Alicante-España)

T+34 965 881 175 - F+34 965 881 919 - www.ceramicamayor.com

Mayor
CERÁMICA

CERÁMICA MAYOR

SERIE Gres
porcelánico
extrusionado
BORRIOL



SERIE BORRIOL

Gres Porcelánico Extrusionado

Bases_ Medidas nominales



Borriol

25x25 **(M-392)m²**
31,6x31,6 **(M-395)m²**



Borriol

31,6x47 **(M-410)m²**

Piezas especiales



25x33 PELDAÑO CURVO **(M-320)**
31,6x33 PELDAÑO CURVO **(M-340)**



ZANQUÍN DCHO / IZDO CURVO **(M-340)**



120x33 PELDAÑO CURVO **(M-419)**



16x25 VIERTEAGUAS **(M-260)**



33x33 PELDAÑO CURVO ANGULAR CORTE
(M-392)



9x25 RODAPIÉ **(M-153)**
9x31,6 RODAPIÉ **(M-170)**



SERIE BORRIOL

Medidas reales aproximadas en cm.

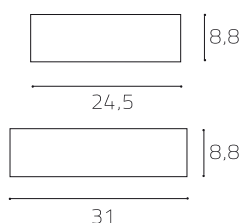

Rodapié

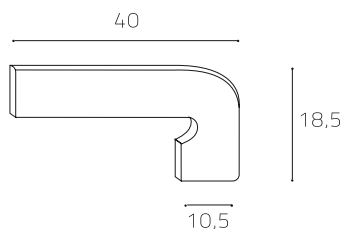

Zanquín dcho./izq. curvo

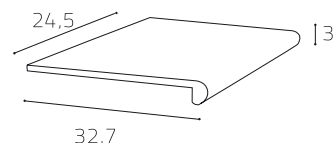

Peldaño curvo

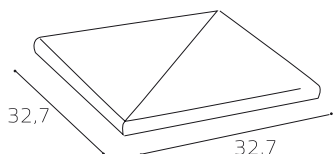

Peldaño curvo angular corte

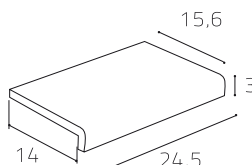

Vierteaguas

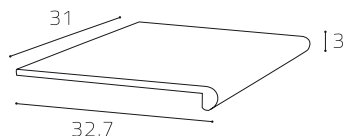

Peldaño curvo

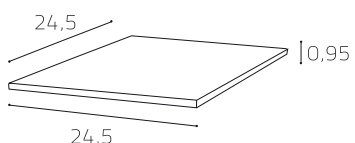

Base

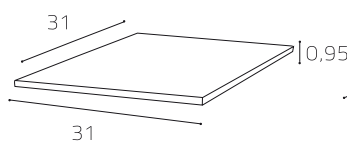

Base

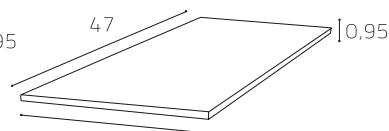

Base

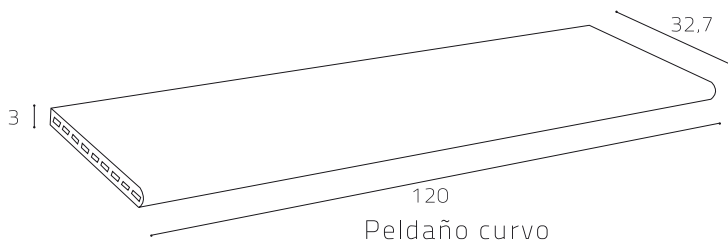

Peldaño curvo

Características Técnicas - Serie BORRIOL



Resistencia a la abrasión

IV



Resistencia a las heladas

Cumple



Resistencia al choque térmico

Cumple



Resistencia a la flexión

>23N / MM2



Antideslizante

Clase 3



Resistencia a las manchas

Clase 5



Resistencia al rayado

8



Absorción de agua

<0,5

BASES	Medidas	Piezas/Caja	m ² /Caja	Cajas/Palet	Piezas/Palet	m ² /Palet	Kgs/Palet (aprox)
	25x25 cm - 9,8"x9,8"	16	1,00	78	1.248	78,00	1.513
	31,6x31,6 cm - 12,4"x12,4"	10	1,00	60	600	60,00	1.300
	31,6x47 cm - 12,4"x18,3"	12	1,78	32	384	56,96	1.400
PIEZAS ESPECIALES	Medidas	Piezas/Caja	Cajas/Palet	Piezas/Palet	kgs/Caja	Kgs/Palet (aprox)	
	RODAPIÉ 9x25 cm - 3,5"x9,8"	28	99	2.772	13,64	1.350	
	RODAPIÉ 9x31,6 cm - 3,5"x12,4"	22	99	2.178	12,96	1.283	
	PELDAÑO 25x33 cm - 9,8"x13"	6	80	480	12,03	962	
	PELDAÑO 31,6x33 cm - 12,4"x13"	6	60	360	19,68	1.181	
	PELDAÑO 120X33 cm - 46,8"x13"	1	75	75	21,60	1.620	
	PELDAÑO ANG. CORTE 33x33 cm - 13"x13"	4	48	192	12,96	622	
	ZANQUÍN DCHO.-IZDO.	10	80	800	10,38	830	
VIERTEAGUAS 16x25 cm - 6,3"x9,8"	10	96	960	13,45	1.291		

Mayor
CERÁMICA



CERÁMICA MAYOR S.A. Partida Planet, s/n - 03510 Callosa d'En Sarrià (Alicante - España)
T +34-965 881 175 - F +34-965 881 919 - www.ceramicamayor.com - e-mail: mayor@ceramicamayor.com

CERÁMICA MAYOR

SERIE
PEDRA

Gres
porcelánico
extrusionado



SERIE PEDRA

Gres porcelánico extrusionado

Bases_ Medidas nominales



Montserrat

31,6x31,6 (M-393)m²

31,6x47 (M-400)m²



Gredos

31,6x31,6 (M-393)m²

31,6x47 (M-400)m²



Teide

31,6x31,6 (M-393)m²

31,6x47 (M-400)m²

Piezas especiales_ Disponibles en todos los colores



31,6x33 PELDAÑO (M-345)



33x33 PELDAÑO ANGULAR CORTE (M-392)



9x31,6 RODAPIÉ (M-170)



120X33 PELDAÑO CURVO (M-419)



ZANQUÍN DCHO/ IZDO (M-340)



ZANQUÍN CORTE DCHO/ IZDO (M-250)



BASES	Medidas	Piezas/ Caja	m ² / Caja	Cajas/ Palet	Piezas/ Palet	m ² / Palet	Kgs/ Palet (aprox)
	31,6x31,6 cm - 12,4"x12,4"	10	1,00	60	600	60,00	1.300
	31,6x47 cm - 12,4"x18,5"	8	1,19	48	384	57,12	1.200
PIEZAS ESPECIALES	Medidas	Piezas/ Caja	Cajas/ Palet	Piezas/ Palet	kgs/ Caja	Kgs/ Palet (aprox)	
	RODAPIÉ 9x31,6 cm - 3,5"x12,4"	22	99	2.178	12,96	1.283	
	PELDAÑO 31,6x33 cm - 12,4"x13"	6	60	360	19,68	1.181	
	PELDAÑO 120x33 cm - 46,8"x13"	1	75	75	21,60	1.620	
	PELDAÑO ANG. CORTE 33x33 cm - 13"x13"	4					
	ZANQUÍN DCHO.- IZDO.	10	80	800	10,38	830	
ZANQUÍN CORTE DCHO/ IZDO.	22	99	2.178				

SERIE PEDRA

Medidas nominales en cm.

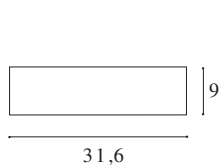

Rodapié

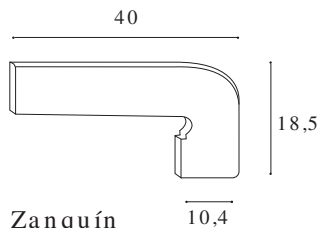

Zanjín dcho./ izq.

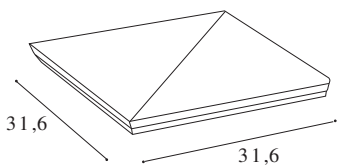

Peldaño angular corte

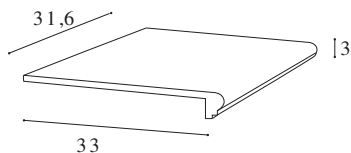

Peldaño

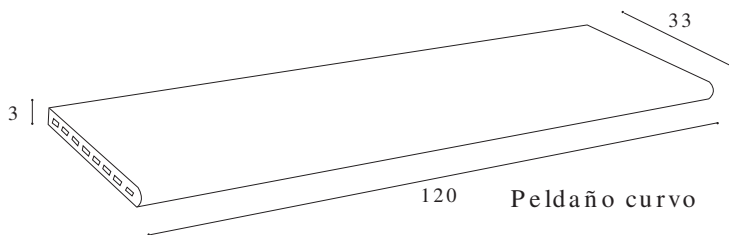

Peldaño curvo

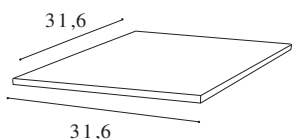

Base

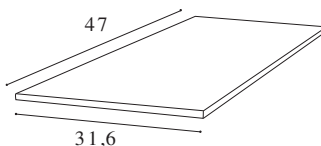

Base

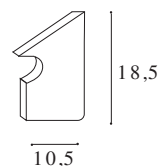

Zanjín corte dcho./ izq.

Características Técnicas - Serie PEDRA (Montserrat y Gredos)



Resistencia a la abrasión

IV



Resistencia a las heladas

Resiste



Resistencia al choque térmico

Resiste



Resistencia a la flexión

>26N/ mm²



Antideslizante

Clase 1



Resistencia a las manchas

Clase 5



Resistencia al rayado

6



Absorción de agua

<0,5%

Características Técnicas - Serie PEDRA (Teide)



Resistencia a la abrasión

III



Resistencia a las heladas

Resiste



Resistencia al choque térmico

Resiste



Resistencia a la flexión

>26N/ mm²



Antideslizante

Clase 2



Resistencia a las manchas

Clase 5



Resistencia al rayado

5



Absorción de agua

<0,5%



CERÁMICA MAYOR S.A.

Partida Planet, s/n - 03510 Callosa d'En Sarrià (Alicante - España)
T+34 965 881 175 - F+34 965 881 919 - www.ceramicamayor.com



CERÁMICA MAYOR

SERIE Gres
porcelánico
extrusionado
PORTO

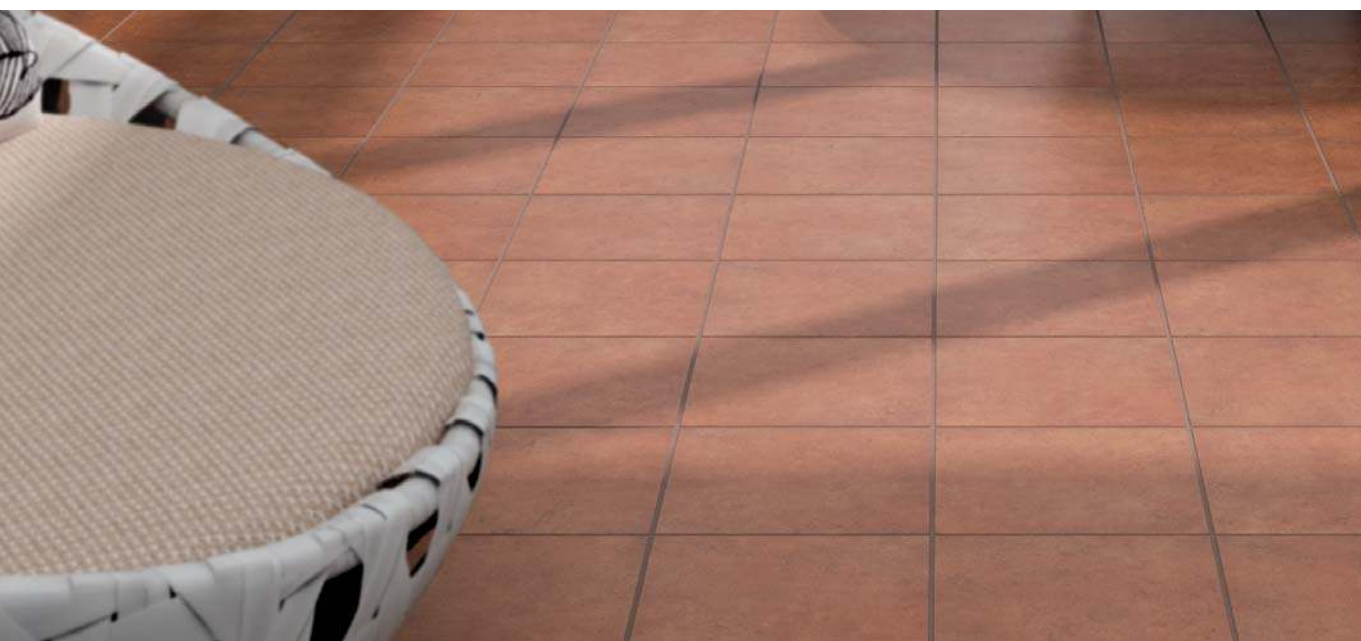

SERIE PORTO

Gres Porcelánico Extrusionado

Bases_ Medidas nominales



Porto

25x25 **(M-391)m²**

Piezas especiales



25x33 PELDAÑO CURVO **(M-320)**



9x25 RODAPIÉ **(M-153)**



ZANQUÍN CORTE DCHO / IZDO **(M-250)**

BASES	Medidas	Piezas/Caja	m²/Caja	Cajas/Palet	Piezas/Palet	m²/Palet	Kgs/Palet (aprox)
	25x25 cm - 9,8"x9,8"	16	1,00	78	1.248	78,00	1.513
PIEZAS ESPECIALES	Medidas	Piezas/Caja	Cajas/Palet	Piezas/Palet	kgs/Caja	Kgs/Palet (aprox)	
	RODAPIÉ 9x25 cm - 3,5"x9,8"	28	99	2.772	13,64	1.350	
	PELDAÑO 25x33 cm - 9,8"x13"	6	80	480	12,03	962	
	ZANQUÍN CORTE DCHO. / IZDO.	22	99	2.178			



SERIE PORTO

Medidas reales aproximadas en cm.

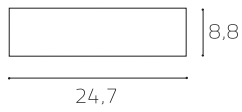

Rodapié

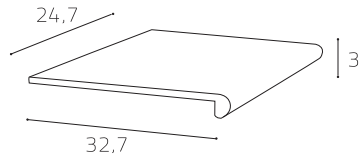

Peldaño curvo

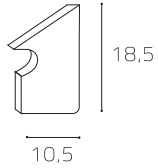

Zanquín corte dcho. / izq

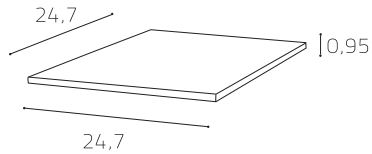

Base

Características Técnicas - Serie PORTO

Resistencia a la abrasión	Resistencia a las heladas	Resistencia al choque térmico	Resistencia a la flexión	Antideslizante	Resistencia a las manchas	Resistencia al rayado	Absorción de agua
III	Cumple	Cumple	>26N / MM2	Clase 2	Clase 5	6	<0,5

CERÁMICA MAYOR

SERIE Gres
porcelánico
extrusionado
CASTILLA

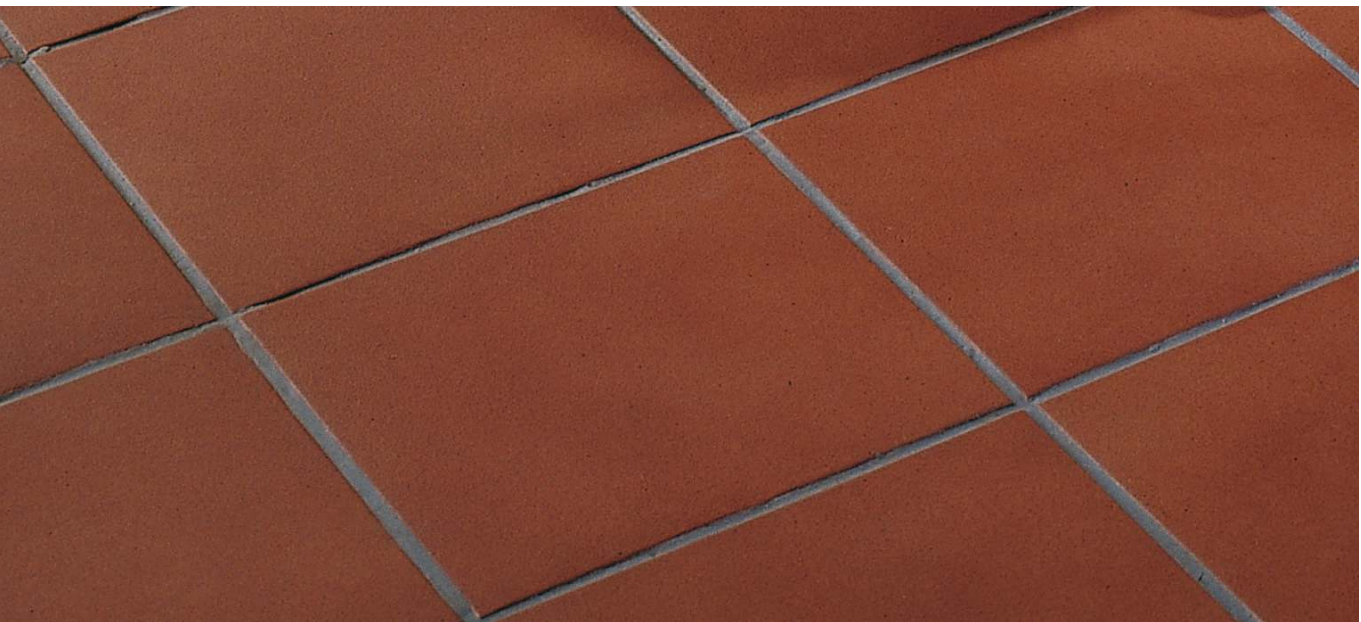



SERIE CASTILLA

Gres porcelánico extrusionado

Bases_ Medidas nominales



Tabaco

25x25 **(M-388)m²**

31,6x31,6 **(M-391)m²**



Avellana

25x25 **(M-388)m²**

31,6x31,6 **(M-391)m²**

Piezas especiales_ Disponibles en todos los colores



120x33 PELDAÑO CURVO **(M-419)**



9x25 RODAPIÉ **(M-150)**

9x31.6 RODAPIÉ **(M-160)**



25x33 PELDAÑO **(M-310)**

31,6x33 PELDAÑO **(M-330)**



33x33 PELDAÑO ANGULAR CORTE **(M-392)**



ZANQUÍN CORTE DCHO / IZDO **(M-250)**



ZANQUÍN DCHO / IZDO **(M-340)**



16x25 VIERTEAGUAS **(M-250)**



PASAMANOS 12* **(M-305)**

PASAMANOS 15* **(M-305)**

* medidas interiores



BASES	Medidas	Piezas/Caja	m ² /Caja	Cajas/Palet	Piezas/Palet	m ² /Palet	Kgs/Palet (aprox)
	25x25 cm - 9,8"x9,8"	16	1,00	75	1.200	75,00	1.455
	31,6x31,6 cm - 12,4"x12,4"	10	1,00	60	600	60,00	1.300
PIEZAS ESPECIALES							
	RODAPIÉ 9x25 cm - 3,5" x9,8"		28	99	2.772	13,64	1.350
	RODAPIÉ 9x31,6 cm - 3,5" x12,4"		22	99	2.178	12,76	1.263
	PELDAÑO 25x33 cm - 9,8"x13"		6	88	528	14,59	1.284
	PELDAÑO 31,6x33 cm - 12,4"x13"		6	66	396	17,70	1.168
	PELDAÑO 120x33 cm - 46,8"x13"		1	75	75	21,60	1.620
	PELDAÑO ANG. CORTE 33x33 cm - 13"x13"		4	48	192	12,96	622
	ZANQUÍN DCHO.-IZDO.		10	80	800	10,38	830
	ZANQUÍN CORTE DCHO./ IZDO.		22	99	2.178	10,78	1.067
	VIERTEAGUAS 16x25 cm - 6,3"x9,8"		10	96	960	13,30	1.276
	PASAMANOS 12x25 cm - 4,7"x9,8"		10	96	960	11,85	1.138
	PASAMANOS 15x25 cm - 5,9"x9,8"		12	72	864	16,20	1.166



SERIE CASTILLA

Medidas reales aproximadas en cm.

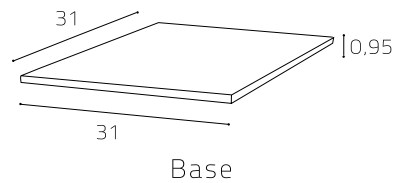
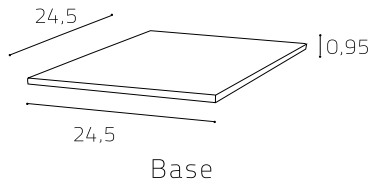
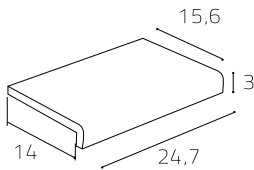
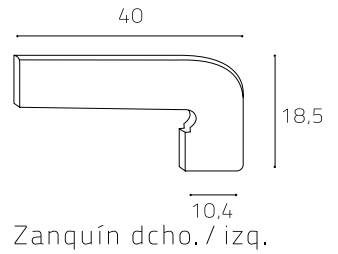
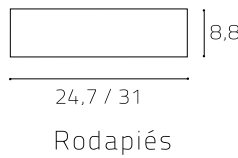
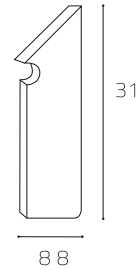
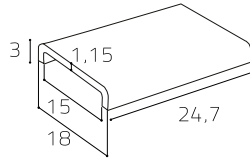
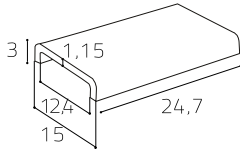
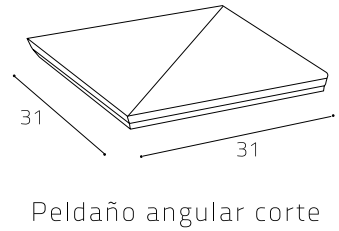
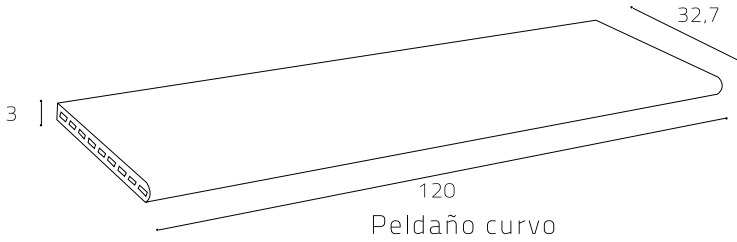

Características Técnicas - Serie CASTILLA (Avellana)

Resistencia a la abrasión	Resistencia a las heladas	Resistencia al choque térmico	Resistencia a la flexión	Antideslizante	Resistencia a las manchas	Resistencia al rayado	Absorción de agua
III	Cumple	Cumple	>23N / MM2	Clase 2	Clase 5	8	<0,5

Características Técnicas - Serie CASTILLA (Tabaco)

Resistencia a la abrasión	Resistencia a las heladas	Resistencia al choque térmico	Resistencia a la flexión	Antideslizante	Resistencia a las manchas	Resistencia al rayado	Absorción de agua
II	Cumple	Cumple	>23N / MM2	Clase 3	Clase 5	6	<0,5



CERÁMICA MAYOR S.A. Partida Planet, s/n - 03510 Callosa d'En Sarrirà (Alicante - España)
T +34 965 881 175 - F +34 965 881 919 - www.ceramicamayor.com - e-mail: mayor@ceramicamayor.com



CERÁMICA MAYOR

SERIE
VALLE

Gres
porcelánico
extrusionado



SERIE VALLE

Gres porcelánico extrusionado

Bases_ Medidas nominales



Beige

31,6x31,6 (M-405)m²



Rojo

31,6x31,6 (M-405)m²

Piezas especiales _ Disponibles en todos los colores



9x31,6 RODAPIÉ (M-170)



ZANQUÍN DCHO/ IZDO. CURVO (M-340)



31,6x33 PELDAÑO CURVO (M-345)

BASES	Medidas	Piezas/ Caja	m ² / Caja	Cajas/ Palet	Piezas/ Palet	m ² / Palet	Kgs/ Palet (aprox)
	31,6x31,6 cm - 12,4"x12,4"	10	1,00	60	600	60,00	1.300
PIEZAS ESPECIALES	Medidas	Piezas/ Caja	Cajas/ Palet	Piezas/ Palet	kgs/ Caja	Kgs/ Palet (aprox)	
	RODAPIÉ 9x31,6 cm - 3,5"x12,4"	22	99	2.178	12,96	1.283	
	PELDAÑO 31,6x33 cm - 12,4"x13"	6	60	360	19,68	1.181	
	ZANQUÍN DCHO/ IZDO.	10	80	800	10,38	830	



SERIE VALLE

Medidas nominales en cm.



Rodapié

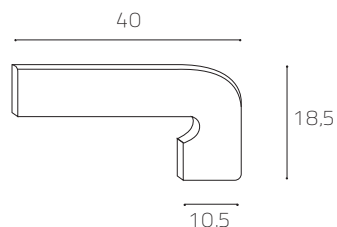

Zanquín dcho. / izq. curvo

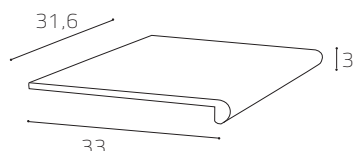

Peldaño curvo

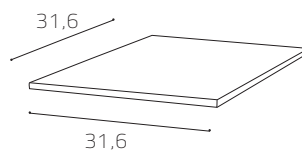

Base

Características Técnicas - Serie VALLE

Resistencia a la abrasión	Resistencia a las heladas	Resistencia al choque térmico	Resistencia a la flexión	Antideslizante	Resistencia a las manchas	Resistencia al rayado	Absorción de agua
III	Resiste	Resiste	>23N / mm ²	Clase 3	Clase 5	7	< 0,5%



Mayor
CERÁMICA

CERÁMICA MAYOR S.A.

Partida Planet, s/n - 03510 Callosa d'En Sarrià (Alicante -España)
T+34 965 881 175 - F+34 965 881 919 - www.ceramicamayor.com

CERÁMICA MAYOR

SERIE Gres
porcelánico
extrusionado
POMPEI



SERIE POMPEI

Gres Porcelánico Extrusionado

Bases_ Medidas nominales



Rojo

31,6x31,6 **(M-405)**m²

Piezas especiales



9x31,6 RODAPIÉ

(M-170)



ZANQUÍN DCHO / IZDO CURVO

(M-340)



31,6x33 PELDAÑO CURVO

(M-345)



33x33 PELDAÑO CURVO ANGULAR CORTE

(M-392)

BASES	Medidas	Piezas/Caja	m ² /Caja	Cajas/Palet	Piezas/Palet	m ² /Palet	Kgs/Palet (aprox)
	31,6x31,6 cm - 12,4"x12,4"	10	1,00	60	600	60,00	1.300
PIEZAS ESPECIALES	Medidas	Piezas/Caja	Cajas/Palet	Piezas/Palet	kgs/Caja	Kgs/Palet (aprox)	
	RODAPIÉ 9x31,6 cm - 3,5"x12,4"	22	99	2.178	12,96	1.283	
	PELDAÑO 31,6x33 cm - 12,4"x13"	6	60	360	19,68	1.181	
	PELDAÑO ANG. CORTE 33x33 cm - 13"x13"	4					
	ZANQUÍN DCHO.-IZDO.	10	80	800	10,38	830	



SERIE POMPEI

Medidas reales aproximadas en cm.

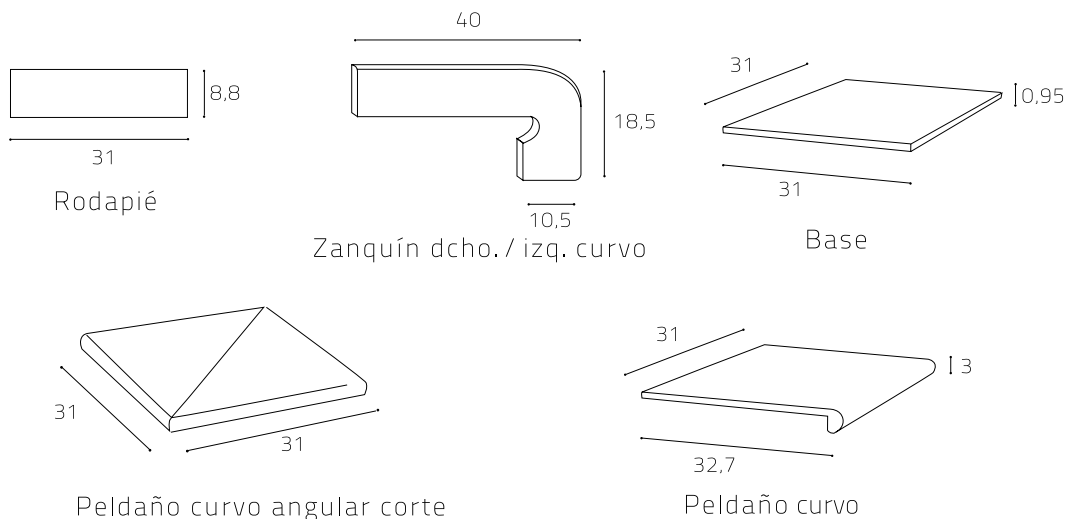

Características Técnicas - Serie POMPEI



Resistencia a la abrasión

III



Resistencia a las heladas

Cumple



Resistencia al choque térmico

Cumple



Resistencia a la flexión

>23N / MM2



Antideslizante

Clase 1



Resistencia a las manchas

Clase 5



Resistencia al rayado

5



Absorción de agua

<0,5



Mayor
CERÁMICA ■■■■

CERÁMICA MAYOR S.A. Partida Planet, s/n - 03510 Callosa d'En Sarrià (Alicante -España)
T +34 965 881 175 - F +34-965 881 919 - www.ceramicamayor.com - e-mail: mayor@ceramicamayor.com