

**ALLCALLAGHERS**

# Catálogo General 2015·2016

GENERAL CATALOGUE  
CATALOGUE GÉNÉRAL  
GESAMTKATALOG



# ÍNDICE GENERAL

GENERAL INDEX ≈ INDEX GÉNÉRAL ≈ VERZEICHNIS

ÍNDICE POR FORMATOS	4
SIZES INDEX ≈ INDEX FORMATS ≈ FORMATVERZEICHNIS	
ÍNDICE POR SERIES	5
RANGES INDEX ≈ INDEX SÉRIES ≈ SERIENVERZEICHNIS	
ALCALAGRES, A SU SERVICIO	6
AT YOUR SERVICE ≈ À VOTRE SERVICE ≈ IN IHREM DIENST	
EFICIENCIA SOSTENIBLE	8
SUSTAINABLE EFFICIENCY ≈ EFFICACITÉ DURABLE ≈ NACHHALTIGE EFFIZIENZ	
EL CATÁLOGO	10
THE CATALOGUE ≈ LE CATALOGUE ≈ DER KATALOG	
SERIES	12
RANGES ≈ SÉRIES ≈ SERIEN	
SERIES BAJO PEDIDO	216
RANGES ON REQUEST ≈ SÉRIES SUR DEMANDE ≈ SERIEN AUF ANFRAGE	
XTREME 2.0, ESPESORADO 20 mm	266
THICKNESS 20 mm ≈ ÉPAISSEUR 20 mm ≈ ÜBERSTÄRKE 20 mm	
INFORMACIÓN TÉCNICA	284
TECHNICAL INFORMATION ≈ INFORMATIONS TECHNIQUES ≈ TECHNISCHE AUSKUNFT	
EXPERTOS EN CALIDAD	286
QUALITY EXPERTS ≈ EXPERTS DE QUALITÉ ≈ QUALITÄTS-FACHLEUTE	
ANTIDESLIZANTE	288
ANTI-SLIP ≈ ANTIDÉRAPANT ≈ RUTSCHHEMMEND	
APLICACIONES ESPECIALES	290
SPECIAL APPLICATIONS ≈ APPLICATIONS SPÉCIALES ≈ SPEZIAL ANWENDUNGEN	
CARACTERÍSTICAS TÉCNICAS	292
TECHNICAL CHARACTERISTICS ≈ CARACTERISTIQUES TECHNIQUES ≈ TECHNISCHE EIGENSCHAFTEN	
SUGERENCIAS DE COLOCACIÓN	294
SUGGESTIONS OF INSTALLATION ≈ DES SUGGESTIONS D'INSTALLATION ≈ VORSCHLÄGE DER INSTALLATION	
LIMPIEZA Y MANTENIMIENTO	298
CLEANING AND MAINTENANCE ≈ NETTOYAGE ET MAINTENANCE ≈ REINIGUNG u. PFLEGE	
INFORMACIÓN DE INTERÉS	302
NOTES ≈ INFORMATION COMPLÉMENTAIRE ≈ INFORMATIONEN	

# ÍNDICE POR FORMATOS

SIZES INDEX ≈ INDEX FORMATS ≈ FORMATVERZEICHNIS

## 15 x 90 cm (6" x 36")

IRONWOOD .....	55-60
LEGNO .....	70-73
MADERAS.....	100-103

## 22,5 x 90 cm (9" x 36")

IRONWOOD .....	55-60
LEGNO .....	70-73
MADERAS.....	100-103
TÉCNICA.....	254-263

## 30 x 30 cm (12" x 12")

RÍOS.....	224-226
-----------	---------

## 30 x 60 cm (12" x 24")

CONCEPT .....	22-27
DOLMEN.....	38-41
LIFESTONE .....	86-89
ONIX.....	114-115
PERSEO .....	137-139
PÓRTLAND .....	150-153
QUANTUM .....	168-170
QUARCITY.....	182-185
ROMA.....	196-200
SILEX.....	210-213
TÉCNICA.....	254-263

## XTREME 2.0, ESPESORADO 20 mm

THICKNESS 20 mm ≈ ÉPAISSEUR 20 mm ≈ ÜBERSTÄRKE 20 mm

## 45 x 45 cm (18" x 18")

DOLMEN.....	38-41
XTREME 2.0 .....	280

## 60 x 60 cm (24" x 24")

DOLMEN.....	38-41
IRONWOOD .....	55-60
QUANTUM .....	168-170
QUARCITY.....	182-185
XTREME 2.0 .....	278-282

## 40 x 40 cm (16" x 16")

RÍOS.....	222-227
TÁCTIL .....	237-239

## 45 x 90 cm (18" x 36")

LIFESTONE .....	86-89
ONIX.....	114-115
OTRANTO .....	124-126
PERSEO .....	137-139
PÓRTLAND .....	150-153
ROMA.....	196-200
TÉCNICA.....	254-263

## 60 x 60 cm (24" x 24")

CONCEPT .....	22-27
DOLMEN.....	38-41
LIFESTONE .....	86-89
OTRANTO .....	124-126
PERSEO .....	137-139
PÓRTLAND .....	150-153
QUANTUM .....	168-170
QUARCITY.....	182-185
RÍOS.....	225-227
ROMA.....	196-200
TÉCNICA.....	254-263

# ÍNDICE POR SERIES

RANGES INDEX ≈ INDEX SÉRIES ≈ SERIENVERZEICHNIS

## 12 CONCEPT



## 30 DOLMEN



## 44 IRONWOOD



## 62 LEGNO



## 76 LIFESTONE



## 92 MADERAS



## 106 ONIX



## 118 OTRANTO



## 128 PERSEO



## 142 PORTLAND



## 156 QUANTUM



## 172 QUARCITY



## 188 ROMA



## 204 SILEX



## 216 RÍOS



## 230 TÁCTIL



## 240 TÉCNICA



## 266 XTREME 2.0 ≈ 20 mm



# ALCALAGRES® a su servicio

AT YOUR SERVICE  
À VOTRE SERVICE  
IN IHREM DIENST



## ESPAÑOL

Alcalagres, S.A., fundada en 1990, está especializada en la fabricación y comercialización de gres porcelánico integral, para su uso en pavimentos y revestimientos de todos los ámbitos.

El centro de producción y las oficinas centrales sitos en Camarma de Esteruelas (Madrid), y un almacén logístico situado en Burriana (Castellón), permiten materializar el suministro de los pedidos realizados por todos nuestros clientes. Alcalagres cuenta con una red de distribución nacional e internacional que nos permite exportar a más de 85 países de los cinco continentes.

Estamos comprometidos con la calidad, todos nuestros productos están supervisados por las directrices de la norma UNE-EN-ISO 9001:2000, que garantiza la investigación, el desarrollo y la comercialización con las máximas garantías. Trabajamos con las mejores materias primas del mercado, sometidas a los controles más estrictos, que nos permiten obtener las excepcionales características técnicas del Porcelánico Integral: alta resistencia a la flexión >2000 N, al tránsito intenso con un desgaste superficial <145 mm<sup>3</sup>, a las heladas, al ataque químico, un nivel de absorción de agua <0,1%... y una gran variedad de modelos, formatos y acabados.

## ENGLISH

Alcalagres S.A., a company founded in 1990, has been manufacturing and selling integral porcelain tiles for all kinds of flooring and wall tiling solutions.

The manufacturing plant and main offices in Camarma de Esteruelas, Madrid, and the logistics warehouse in Burriana, Castellón, make it possible to supply and deliver all the items in customers' orders. Through its national and international distribution network, Alcalagres exports tiles to more than 85 countries in all five continents.

As a result of our commitment to quality, all of our products comply with the guidelines of the UNE-EN-ISO 9001:2000 standard, which guarantees that our research, development and commercialisation are carried out with the maximum guarantees. We work with the finest raw materials available on the market, which undergo the strictest controls to allow us to obtain the exceptional technical characteristics of Integral Porcelain Tiles: high bending resistance (>2000 N), high resistance to surface wear (<145 mm<sup>3</sup>), to freezing and chemical attack, with a water absorption level of <0.1% and a wide range of models, formats and finishes.

## FRANÇAIS

Fondée en 1990, Alcalagres, S.A. est une société spécialisée dans la fabrication et la commercialisation de grès porcelainé intégral pour le revêtement des murs et des sols dans tous les domaines.

Notre usine de production et nos bureaux centraux se trouvent à Camarma de Esteruelas (province de Madrid), et nous possédons un magasin logistique situé à Burriana (province de Castellón). Alcalagres dispose d'un réseau de distribution en Espagne et à l'étranger qui lui permet d'exporter dans plus de 85 pays des cinq continents.

Du fait de notre engagement pour la qualité, tous nos produits sont soumis aux procédures imposées par la norme UNE-EN-ISO 9001:2000, qui garantit que la recherche, le développement et la commercialisation s'effectuent avec les plus grandes garanties. Nous travaillons avec les meilleures matières premières du marché, qui sont soumises aux contrôles les plus rigoureux pour ainsi obtenir les caractéristiques techniques exceptionnelles de notre grès porcelainé intégral : résistance élevée à la flexion >2000 N, résistance au trafic intense avec une usure de surface <145 mm<sup>3</sup>, résistance au gel et aux produits chimiques, un niveau d'absorption d'eau <0,1%... et une grande variété de modèles, de formats et de finitions.

## DEUTSCH

Alcalagres, S.A. – 1990 gegründet – ist auf die Herstellung und den Vertrieb von Feinsteinzeug für Bodenbeläge und Fassadenverkleidungen in allen Bereichen spezialisiert.

Die Fabrik und die Zentrale befinden sich in Camarma de Esteruelas (Madrid), das Logistikhauptlager in Burriana (Castellón); von hier aus werden die Bestellungen aller unserer Kunden geliefert. Alcalagres verfügt über ein nationales und internationales Vertriebsnetz, das uns die Möglichkeit gibt, in über 85 Länder auf 5 Kontinenten zu exportieren.

Wir haben uns der Qualität verschrieben: alle unsere Produkte werden nach den Bestimmungen der Vorschrift UNE-EN-ISO 9001:2000 kontrolliert, womit eine Forschung, Entwicklung und Kommerzialisierung mit maximalen Garantien gewährleistet ist. Unsere Rohstoffe sind die besten des Marktes und werden strengsten Kontrollen unterzogen, weshalb wir die hervorragenden technischen Merkmale unseres ganzscherbis durchgefärbten Feinsteinzeugs erzielen können: eine hohe Biegefestigkeit von >2000 N, eine Abriebbeständigkeit bei starkem Personenverkehr von <145 mm<sup>3</sup>, Frostbeständigkeit, Widerstandsfähigkeit gegen chemische Einwirkungen, eine geringe Wasseraufnahme von <0,1% usw., ebenso wie eine große Vielfalt an Modellen, Formaten und Ausführungen.

# Eficiencia sostenible

SUSTAINABLE EFFICIENCY  
EFFICACITÉ DURABLE  
NACHHALTIGE EFFIZIENZ



## ■ ES

Caracterizados por el espíritu ecológico, Alcalagres aúna el desarrollo industrial con la sostenibilidad del mismo, teniendo siempre como objetivo el cuidado del entorno natural en el que se desarrolla nuestra actividad.

Hemos incorporado la maquinaria más eficiente y moderna del mercado desde el punto de vista de rendimiento, pero también la menos contaminante.

Haciéndonos eco del concepto MTD (Mejores Técnicas Disponibles) de las directivas europeas, hay que resaltar dos puntos, por un lado que, Alcalagres únicamente consume dos tipos de energía: electricidad y gas natural, y por otro que, todos los dispositivos susceptibles de expulsar algún tipo de gas al exterior están provistos de filtros de mangas, para reducir y controlar las emisiones a la atmósfera.

Este esfuerzo constante nos ha permitido cumplir con las exigencias de la Norma UNE-EN-ISO 14001:2004 y la concesión por parte de AENOR del Certificado de Gestión Ambiental, reconocido internacionalmente a través de la Certificación IQNet. Además, la Consejería de Medio Ambiente nos concedió la "Autorización Ambiental Integrada" acreditando el esfuerzo de Alcalagres en ser cada día una empresa más "verde".

El firme compromiso con la NO generación de residuos, nos ha llevado en los últimos años a investigar en el proceso de reciclado de las baldosas de rechazo por rotura, obteniendo como resultado más de 30 modelos fabricados con material reciclado, que cumplen con las mismas exigencias de calidad que el resto de productos pero generan menos contaminación. Todo ello ha sido compensado con la obtención de la UNE-EN-ISO 14021 referente al etiquetado "verde" de los productos, bajo la supervisión de Bureau Veritas, garantizando de esta forma que nuestros productos son respetuosos con el medio Ambiente y aptos para el uso de manera eficiente en todos aquellos edificios que aspiren a ser clasificados "Edificios Sostenibles LEEDS®".

## ■ EN

Marked by a strongly ecological spirit, Alcalagres combines industrial development and sustainability, with the clear objective of caring for the natural environment in which we carry out our activity.

We have incorporated the most modern and efficient machinery on the market in terms of performance, which also produces less pollution.

Taking into account the concept of Best Available Techniques (BAT) defined in European Union directives, it is especially important to note that Alcalagres only consumes two types of energy: electricity and natural gas, and that all of the machinery it uses that emits any type of gas into the atmosphere is equipped with sleeve filters to reduce emissions.

These constant efforts have led to us meeting the requirements of the UNE-EN-ISO 14001:2004 standard and being awarded the Environmental Management Certificate by the Spanish certification body AENOR, recognised internationally through the IQNet Certification.

The Regional Ministry of the Environment has also awarded us with "Integrated Environmental Authorisation" in acknowledgement of the efforts Alcalagres makes to be an increasingly green company.

In recent years, our firm commitment to not produce waste materials has led us to research the process of recycling tiles that are rejected from the production line due to breakage, obtaining more than 30 models made using recycled material that meet the same stringent quality requirements as the rest of our products, but which produce less contamination.

All of this work has been rewarded by the company being granted UNE-EN-ISO 14021 certification for the green label on its products, under the supervision of Bureau Veritas, thereby guaranteeing that our products are environmentally friendly and suitable for efficient use in all buildings that aspire to be classified as LEEDS® sustainable buildings.

## ■ FR

Fidèle à son esprit écologique, la société Alcalagres allie le développement industriel à la durabilité de ce dernier en se fixant toujours comme objectif la protection du milieu naturel dans lequel son activité prend place.

Nous avons acquis les équipements les plus efficaces et modernes du marché en termes de rendement, mais qui sont en même temps les moins polluants.

Signes de son intérêt pour le concept MTD (Meilleures Techniques Disponibles) des directives européennes, il faut souligner, d'une part, qu'Alcalagres consomme uniquement deux types d'énergies, électricité et gaz naturel, et d'autre part, que tous les dispositifs susceptibles de dégager l'un ou l'autre type de gaz à l'extérieur sont équipés de filtres à manches, de manière à réduire et à contrôler les émissions dans l'atmosphère.

Cet effort constant nous a permis de satisfaire aux exigences de la norme UNE-EN-ISO 14001:2004 et d'obtenir de l'AENOR le Certificat de Gestion Environnementale, reconnu à l'échelle internationale à travers la Certification IQNet.

Par ailleurs, le Département de l'Environnement nous a accordé « l'Autorisation Environnementale Intégrée », qui assure qu'Alcalagres est une entreprise toujours plus « verte ».

Notre engagement ferme pour la NON production de déchets nous a menés ces dernières années à réaliser des recherches concernant le processus de recyclage des carreaux mis au rebut pour cause de rupture, ce qui a donné lieu à la fabrication de plus de 30 modèles à partir de matériau recyclé, qui satisfont aux mêmes exigences de qualité que les autres produits, mais génèrent moins de pollution.

Tous ces efforts ont été compensés par l'obtention d'un certificat de conformité à la norme UNE-EN-ISO 14021, relative à l'étiquette « verte » des produits, sous la supervision de Bureau Veritas, ce qui garantit que nos produits sont respectueux de l'environnement et valables pour une utilisation efficace dans tous les bâtiments candidats à être classés « Bâtiments Durables » LEEDS®.

## ■ DE

Das Unternehmen Alcalagres zeichnet sich durch sein Umweltengagement aus und verbindet die industrielle mit einer nachhaltigen Entwicklung, wobei wir immer auf die Bewahrung der natürlichen Umgebung achten, in der wir unsere Tätigkeit abwickeln. Unsere Maschinen sind von ihrer Leistung her die effizientesten und modernsten auf dem Markt und gleichzeitig auch diejenigen, die am umweltfreundlichsten sind.

Unter Verwirklichung des Konzepts BVT (beste verfügbare Technik) gemäß den europäischen Richtlinien ist speziell auf zwei Punkte hinzuweisen: zum einen verwendet Alcalagres nur zwei Energiearten, nämlich Strom und Erdgas, und zum anderen sind alle Geräte, die evtl. irgendein Gas in die Luft ausstoßen könnten, mit Schlauchfiltern ausgestattet, um die Emissionen in die Luft zu reduzieren und zu kontrollieren.

Aufgrund dieser konstanten Bemühungen können wir die Anforderungen der Vorschrift UNE-EN-ISO 14001:2004 erfüllen und erhielten von der Spanischen Vereinigung für Normierung und Zertifizierung AENOR das Umweltmanagementzertifikat, das international über die IQNET-Zertifizierung anerkannt ist.

Außerdem hat uns das regionale Umweltministerium die „Integrale Umweltgenehmigung“ verliehen, mit der die Bemühungen von Alcalagres, Tag für Tag ein „grüneres“ Unternehmen zu werden, gewürdigt wurden.

Diese standhafte Verpflichtung, KEINE Abfälle zu erzeugen, hat in den letzten Jahren dazu geführt, dass wir bei unserer Forschung zum Recycling der wegen Bruches ausgesonderten Fliesen große Fortschritte gemacht haben, sodass jetzt über 30 Modelle mit recyceltem Material hergestellt werden, die alle dieselben Qualitätsansprüche erfüllen, wie unsere restlichen Produkte, aber gleichzeitig wesentlich umweltfreundlicher sind. All diese Anstrengungen wurden belohnt, als wir die Zertifizierung nach UNE-EN-ISO 14021 mit dem Ökolabel für unsere Produkte erhalten haben, die vom Bureau Veritas überwacht wird. Damit wird gewährleistet, dass unsere Produkte umweltfreundlich und effizient für all diejenigen Gebäude verwendet werden können, die als „nachhaltige LEEDS®-Gebäude“ eingestuft werden sollen.

# El catálogo

THE CATALOGUE  
LE CATALOGUE  
DER KATALOG

FORMATOS  
SIZES≈FORMATS≈FORMAT

INDICACIONES TÉCNICAS  
TECHNICAL NOTES  
NOTES TECHNIQUES  
ANWEISUNGEN



**RECTIFICADO Y BISELADO**  
RECTIFIED AND BEVEL  
RECTIFIÉ ET BISEAUTÉ  
REKTIFIZIERT u. GEFASST



**PRODUCTO NATURAL**  
NATURAL PRODUCT  
PRODUIT NATUREL  
NATÜRLICHE PRODUKTE



**RESISTENTE AL TRÁNSITO**  
RESISTANT TO HIGH FOOT TRAFFIC  
HAUTE TRANSIT  
ABRIEBBESTÄNDIG BEI BEGEHUNG



**RESISTENTE A LAS HELADAS**  
FROST RESISTANCE  
RÉSISTANCE AU GEL  
FROSTSICHER



**RESISTENTE A LOS ÁCIDOS**  
ACID RESISTANT  
RÉSISTANT AUX ACIDES  
SÄUREBESTÄNDIG



**RESISTENTE A LAS MANCHAS**  
STAIN RESISTANT  
RÉSISTANT AUX TÂCHES  
FLECKENRESISTENT



**NECESARIA JUNTA 2MM**  
2MM JOINT REQUIRED  
JOINTS DE 2 MM EXIGÉE  
2MM-FUGEN ERFORDERLICH



**USO SUELO Y PARED, INTERIORES Y EXTERIORES**  
MULTIPLE USES  
MULTI USAGES  
MEHRZWECKANWENDUNG



**DESTONIFICACIÓN INTENCIONADA**  
INTENTIONALLY NON-HOMOGENEOUS COLOUR  
DES VARIATION DE NUANCES INTENTIONNÉES  
DESIGNGEMÄSSE ENTFÄRBUNG



**RECICLADO**  
RECYCLED  
RECYCLÉ  
WIEDERAUFBEREIT

ÁMBITOS DE USO  
AREA OF USE  
DOMAINES D'UTILISATION  
ANWENDUNGWEISE

SERIE  
RANGE≈SÉRIE≈SERIE

MODELOS  
MODELS≈MODÈLES≈MODELLE

ACABADOS  
FINISHES≈FINITIONS≈AUSFÜHRUNGEN

## CONCEPT

PORCELÁNICO≈PORCELAIN TILE≈GRÉS CÉRAMÉ≈FEINSTEINZEUG

### CARACTERÍSTICAS TÉCNICAS TECHNICAL CHARACTERISTICS

#### FORMATOS≈SIZES

30 x 60 cm (12" x 24")  
60 x 60 cm (24" x 24")



Consulte página 10-See page 10-  
Voir page 10-Sehen Sie Seite 10

#### ÁMBITOS DE USO≈AREA OF USE

##### PULIDO / MATE

Idóneo para zonas interiores secas.  
Suitable for dry indoor areas.  
Idéal pour application intérieure sèche.  
Ideal für trockene Innenräume.



##### RÚSTICO

Idóneo para interiores húmedos,  
exteriores y piscinas.  
Suitable for wet indoor areas, outdoor  
areas and swimming pools.  
Idéal pour application intérieure humide  
et pour extérieurs et piscines.  
Ideal für Nassbereiche, innen sowie  
außen und in Schwimmbädern.

#### NORMA≈NORM

NORMA UNE-ENV 12633:2003  
- Concept Mate: Clase 1  
- Concept Rústico: Clase 3

NORMA DIN 51130  
- Concept Rústico: R - 12

NORMA DIN 51097 (Pie descalzo)  
- Concept Rústico: Grupo C



FORMATO	MATE	PULIDO	RÚSTICO
30 x 60	U4 P3 E3 C2	U3 P3 E3 C2	U4 P3 E3 C2
60 x 60	U4 P4 E3 C2	U3 P3 E3 C2	U4 P4 E3 C2

NORMAS  
NORM≈NORME≈NORM

### MODELOS MODELS

MARRÓN

BEIGE

BLANCO

GRIS

GRAFITO

NEGRO

### ACABADOS FINISHES

MATE

PULIDO

RÚSTICO

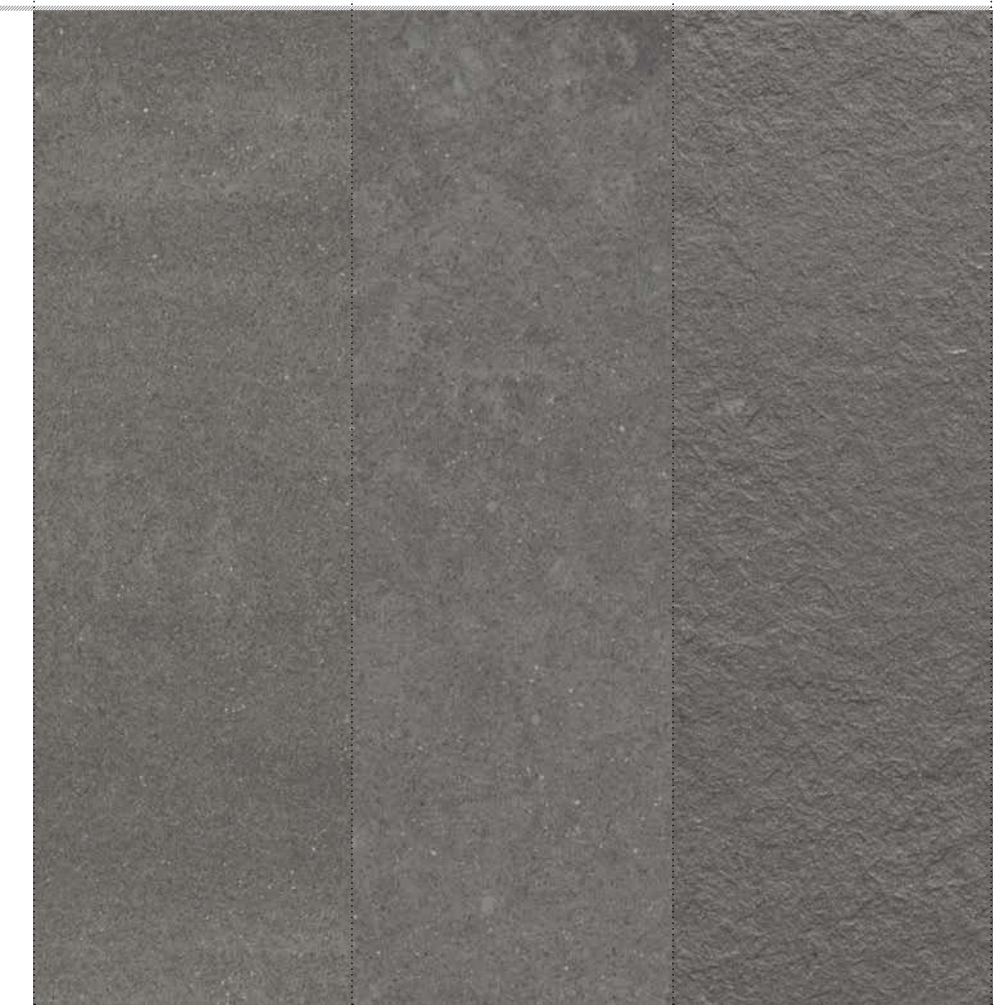

Detalle a escala 1:1 ≈ Detail scale 1:1 ≈ Detail échelle 1:1 ≈ Maßstab 1:1

	MATE	PULIDO	RÚSTICO
MARRÓN	●	●	
BEIGE	●	●	●
BLANCO	●	●	●
GRIS	●	●	
GRAFITO	●	●	●
NEGRO	●	●	●

RESUMEN DE MODELOS Y ACABADOS  
SUMMARY OF RANGES AND FINISHES  
RÉSUMÉ DES MODÈLES ET DE FINITIONS  
MODELLE UND AUSFÜHRUNGEN ZUSAMMENFASSUNG

CONCEPT

DOLMEN

IRONWOOD

LEGNO

LIFESTONE

MADERAS

ONIX

OTRANTO

PERSEO

PORTLAND

QUANTUM

QUARCITY

ROMA

SLEX

RIS

TACTIL

TÉCNICA

XTREME 2.0

TEC

≈ Concept Marrón 60x60 pulido + Concept Beige 30x60 pulido.









# CONCEPT





PORCELÁNICO≈PORCELAIN TILE≈GRÉS CÉRAMÉ≈FEINSTEINZEUG

ACABADOS FINISHES

**CARACTERÍSTICAS TÉCNICAS**  
TECHNICAL CHARACTERISTICS

**FORMATOS≈SIZES**  
30 x 60 cm (12" x 24")  
60 x 60 cm (24" x 24")







Consulte página 10≈See page 10≈  
Voir page 10≈Sehen Sie Seite 10

**ÁMBITOS DE USO≈AREA OF USE**

**PULIDO / MATE**  
Idóneo para zonas interiores secas.  
*Suitable for dry indoor areas.*  
*Idéal pour application intérieure sèche.*  
*Ideal für trockene Innenräume.*





**RÚSTICO**  
Idóneo para interiores húmedos, exteriores y piscinas.  
*Suitable for wet indoor areas, outdoor areas and swimming pools.*  
*Idéal pour application intérieure humide et pour extérieurs et piscines.*  
*Ideal für Nassbereiche, innen sowie außen und in Schwimmbädern.*

**NORMA≈NORM**

NORMA UNE-ENV 12633:2003  
- Concept Mate: Clase 1  
- Concept Rústico: Clase 3

NORMA DIN 51130  
- Concept Rústico: R - 12

NORMA DIN 51097 (Pie descalzo)  
- Concept Rústico: Grupo C

FORMATO	MATE	PULIDO	RÚSTICO
30 x 60	U4 P3 E3 C2	U3 P3 E3 C2	U4 P3 E3 C2
60 x 60	U4 P4 E3 C2	U3 P3 E3 C2	U4 P4 E3 C2

**MODELOS MODELS**

≈

MARRÓN

≈

BEIGE

≈

BLANCO

≈

GRIS

≈

GRAFITO

≈

NEGRO

≈ MATE ≈
≈ PULIDO ≈
≈ RÚSTICO ≈

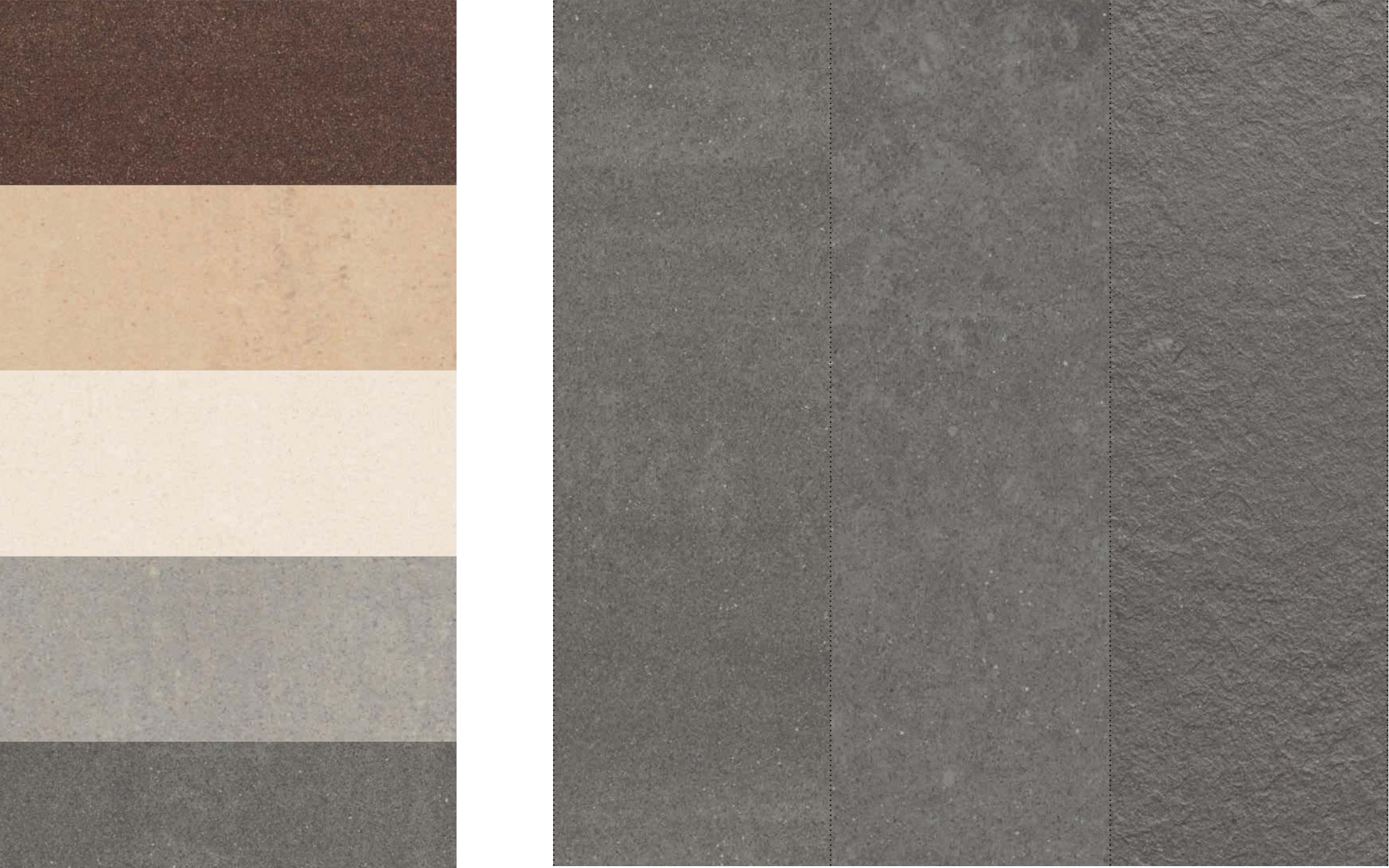

Detalle a escala 1:1 ≈ Detail scale 1:1 ≈ Detail échelle 1:1 ≈ Maßstab 1:1

	MATE	PULIDO	RÚSTICO
MARRÓN	●	●	
BEIGE	●	●	●
BLANCO	●	●	●
GRIS	●	●	
GRAFITO	●	●	●
NEGRO	●	●	●

# CONCEPT

PORCELÁNICO~PORCELAIN TILE~GRÉS CÉRAME~FEINSTEINZEUG

≡ Concept Gris 60x60 pulido + Concept Gris 30x60 mate.



≡ Concept Gris 60x60 pulido.



# CONCEPT

PORCELÁNICO~PORCELAIN TILE~GRÉS CÉRAME~FEINSTEINZEUG

∞ Mosaico Mix Concept Blanco.



# CONCEPT

PORCELÁNICO~PORCELAIN TILE~GRÉS CÉRAME~FEINSTEINZEUG

≡ Concept Beige 30x60 rústico.

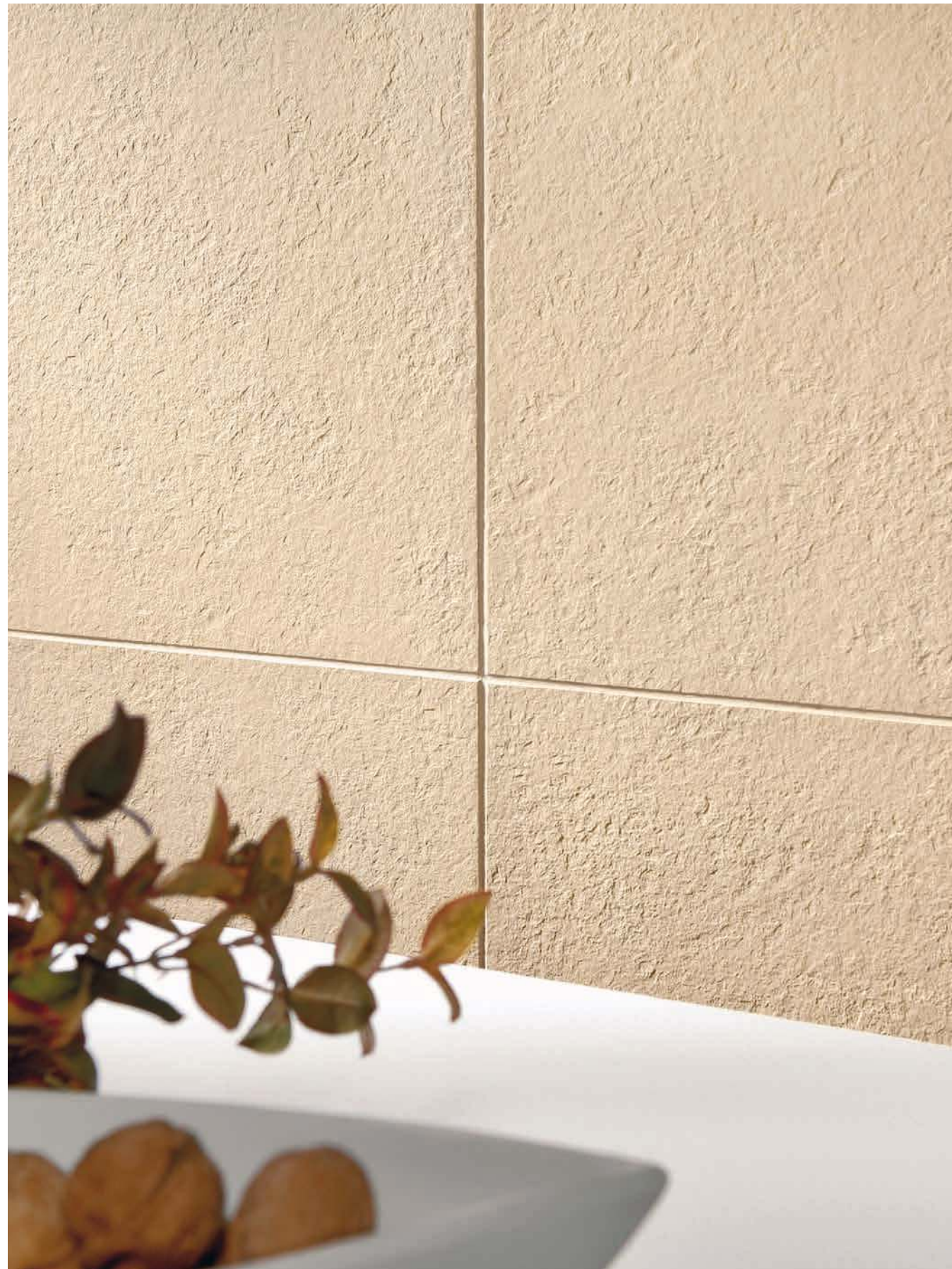

≡ Concept Marrón 30x60 pulido + Mosaico Mix Concept Cálido.

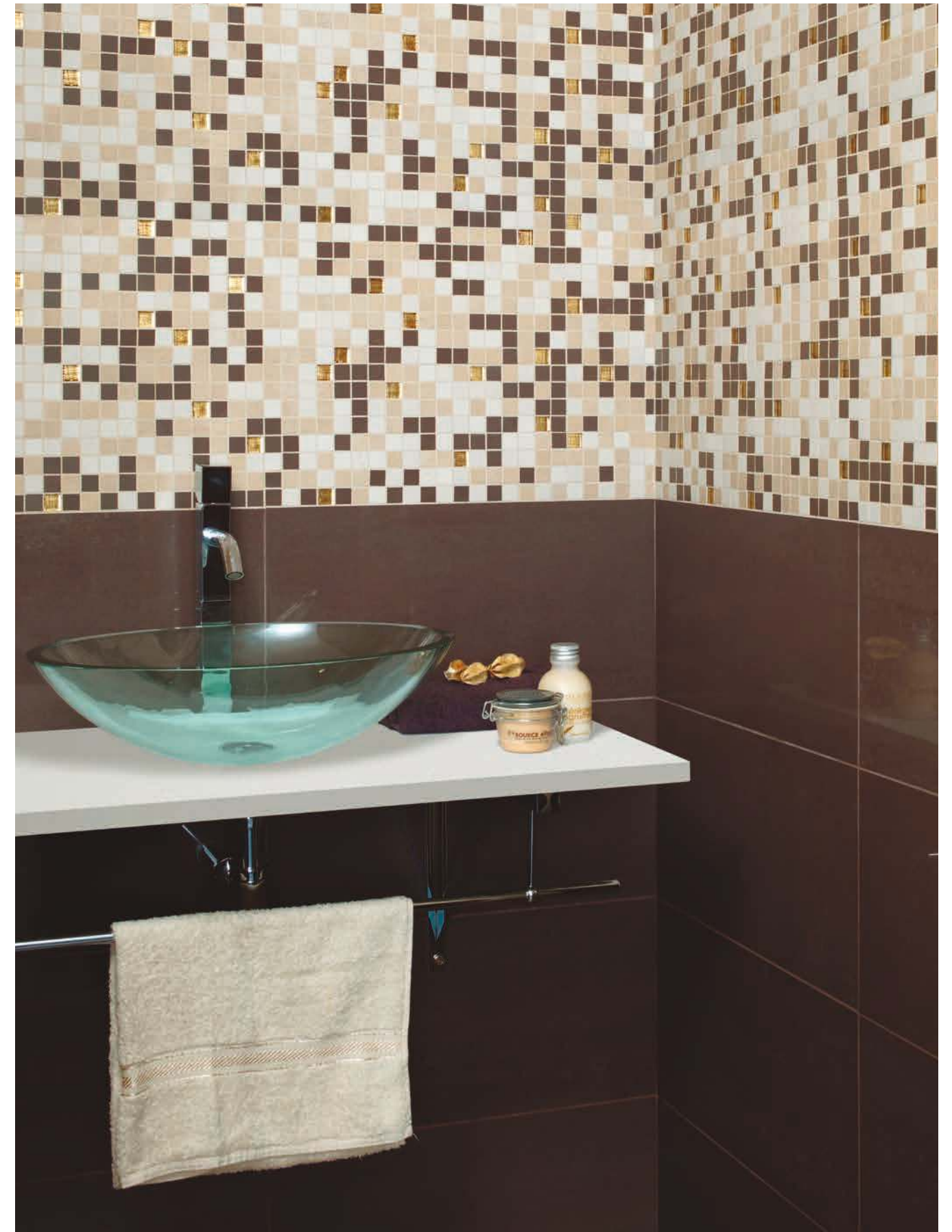

# CONCEPT

PORCELÁNICO≈PORCELAIN TILE≈GRÉS CÉRAMÉ≈FEINSTEINZEUG

DESTONIFICACIÓN INTENCIONADA≈INTENTIONALLY NON-HOMOGENEOUS COLOUR≈  
DES VARIATIONS DE NUANCES INTENTIONNÉES≈DESIGNGEMÄßE ENTFÄRBUNG

## P05 MARRÓN ≡

30x60 cm. (12x24") · MATE



ACABADOS / FINISHES

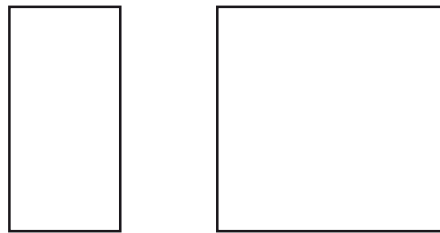

Mate B-37      Mate B-54  
Pulido B-56    Pulido B-63  
30 x 60 cm    60 x 60 cm  
(12" x 24")    (24" x 24")

## P08 BEIGE ≡

30x60 cm. (12x24") · MATE



ACABADOS / FINISHES

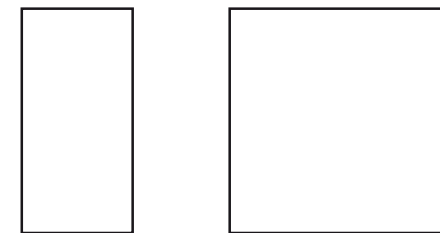

Mate B-37      Mate B-54  
Pulido B-56    Pulido B-63  
Rústico B-39    Rústico B-56  
30 x 60 cm    60 x 60 cm  
(12" x 24")    (24" x 24")

### PACKING LIST

PIEZAS BASE≈BASIC TILES≈ELÉMENTS DE BASE≈GRUNDFLIESEN

CM	SIZE	ACABADO/FINISH	PIEZAS CAJA/ PIECES BOX	KG CAJA	M² CAJA	SQFT BOX	CAJAS/BOXES EUROPALET	M² EUROPALET	SQFT EUROPALET	KG EUROPALET
30 x 60	12" x 24"	MATE	6	24,00	1,08	11,62	48	51,84	558,00	1179,00
30 x 60	12" x 24"	PULIDO	6	22,80	1,08	11,62	48	51,84	558,00	1121,40
60 x 60	24" x 24"	MATE	4	33,20	1,44	15,50	32	46,08	496,00	1089,40
60 x 60	24" x 24"	PULIDO	4	30,40	1,44	15,50	32	46,08	496,00	999,80

### PACKING LIST

PIEZAS BASE≈BASIC TILES≈ELÉMENTS DE BASE≈GRUNDFLIESEN

CM	SIZE	ACABADO/FINISH	PIEZAS CAJA/ PIECES BOX	KG CAJA	M² CAJA	SQFT BOX	CAJAS/BOXES EUROPALET	M² EUROPALET	SQFT EUROPALET	KG EUROPALET
30 x 60	12" x 24"	MATE / RÚSTICO	6	24,00	1,08	11,62	48	51,84	558,00	1179,00
30 x 60	12" x 24"	PULIDO	6	22,80	1,08	11,62	48	51,84	558,00	1121,40
60 x 60	24" x 24"	MATE / RÚSTICO	4	33,20	1,44	15,50	32	46,08	496,00	1089,40
60 x 60	24" x 24"	PULIDO	4	30,40	1,44	15,50	32	46,08	496,00	999,80

# CONCEPT

PORCELÁNICO≈PORCELAIN TILE≈GRÉS CÉRAMÉ≈FEINSTEINZEUG

DESTONIFICACIÓN INTENCIONADA≈INTENTIONALLY NON-HOMOGENEOUS COLOUR≈  
DES VARIATIONS DE NUANCES INTENTIONNÉES≈DESIGNGEMÄßE ENTFÄRBUNG

## P07 BLANCO ≈

30x60 cm. (12x24") · MATE



### ACABADOS / FINISHES

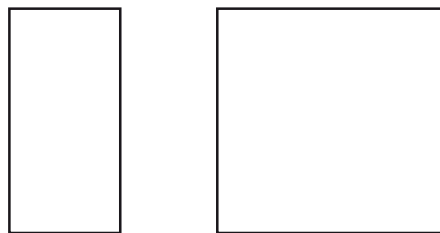

Mate B-43  
Pulido B-62  
Rústico B-45  
30 x 60 cm  
(12" x 24")

Mate B-60  
Pulido B-69  
Rústico B-62  
60 x 60 cm  
(24" x 24")

## P04 GRIS ≈

30x60 cm. (12x24") · MATE



### ACABADOS / FINISHES

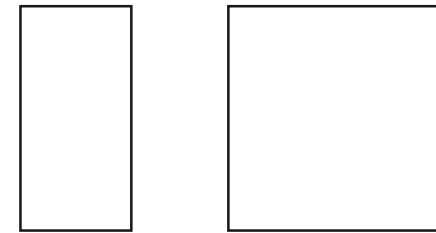

Mate B-37  
Pulido B-56  
30 x 60 cm  
(12" x 24")

Mate B-54  
Pulido B-63  
60 x 60 cm  
(24" x 24")

### PACKING LIST

PIEZAS BASE≈BASIC TILES≈ELÉMENTS DE BASE≈GRUNDFLIESEN

CM	SIZE	ACABADO/FINISH	PIEZAS CAJA/ PIECES BOX	KG CAJA	M² CAJA	SQFT BOX	CAJAS/BOXES EUROPALET	M² EUROPALET	SQFT EUROPALLET	KG EUROPALET
30 x 60	12" x 24"	MATE / RÚSTICO	6	24,00	1,08	11,62	48	51,84	558,00	1179,00
30 x 60	12" x 24"	PULIDO	6	22,80	1,08	11,62	48	51,84	558,00	1121,40
60 x 60	24" x 24"	MATE / RÚSTICO	4	33,20	1,44	15,50	32	46,08	496,00	1089,40
60 x 60	24" x 24"	PULIDO	4	30,40	1,44	15,50	32	46,08	496,00	999,80

### PACKING LIST

PIEZAS BASE≈BASIC TILES≈ELÉMENTS DE BASE≈GRUNDFLIESEN

CM	SIZE	ACABADO/FINISH	PIEZAS CAJA/ PIECES BOX	KG CAJA	M² CAJA	SQFT BOX	CAJAS/BOXES EUROPALET	M² EUROPALET	SQFT EUROPALLET	KG EUROPALET
30 x 60	12" x 24"	MATE	6	24,00	1,08	11,62	48	51,84	558,00	1179,00
30 x 60	12" x 24"	PULIDO	6	22,80	1,08	11,62	48	51,84	558,00	1121,40
60 x 60	24" x 24"	MATE	4	33,20	1,44	15,50	32	46,08	496,00	1089,40
60 x 60	24" x 24"	PULIDO	4	30,40	1,44	15,50	32	46,08	496,00	999,80

# CONCEPT

PORCELÁNICO≈PORCELAIN TILE≈GRÉS CÉRAMÉ≈FEINSTEINZEUG

DESTONIFICACIÓN INTENCIONADA≈INTENTIONALLY NON-HOMOGENEOUS COLOUR≈  
DES VARIATIONS DE NUANCES INTENTIONNÉES≈DESIGNGEMÄßE ENTFÄRBUNG

## P01 GRAFITO ≡

Reciclado

30x60 cm. (12x24") · MATE



### ACABADOS / FINISHES

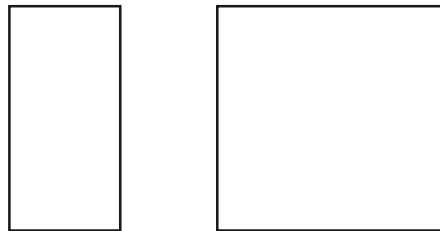

Mate B-37      Mate B-54  
Pulido B-56    Pulido B-63  
Rústico B-39   Rústico B-56  
30 x 60 cm    60 x 60 cm  
(12" x 24")    (24" x 24")

## P02 NEGRO ≡

Reciclado

30x60 cm. (12x24") · MATE



### ACABADOS / FINISHES

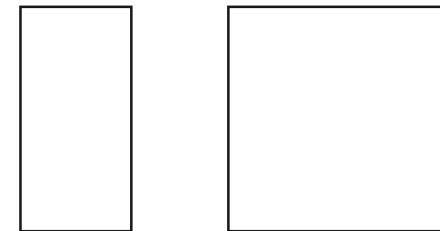

Mate B-37      Mate B-54  
Pulido B-56    Pulido B-63  
Rústico B-39   Rústico B-56  
30 x 60 cm    60 x 60 cm  
(12" x 24")    (24" x 24")

### PACKING LIST

PIEZAS BASE≈BASIC TILES≈ELÉMENTS DE BASE≈GRUNDFLIESEN

CM	SIZE	ACABADO/FINISH	PIEZAS CAJA/ PIECES BOX	KG CAJA	M² CAJA	SQFT BOX	CAJAS/BOXES EUROPALET	M² EUROPALET	SQFT EUROPALLET	KG EUROPALET
30 x 60	12" x 24"	MATE / RÚSTICO	6	24,00	1,08	11,62	48	51,84	558,00	1179,00
30 x 60	12" x 24"	PULIDO	6	22,80	1,08	11,62	48	51,84	558,00	1121,40
60 x 60	24" x 24"	MATE / RÚSTICO	4	33,20	1,44	15,50	32	46,08	496,00	1089,40
60 x 60	24" x 24"	PULIDO	4	30,40	1,44	15,50	32	46,08	496,00	999,80

### PACKING LIST

PIEZAS BASE≈BASIC TILES≈ELÉMENTS DE BASE≈GRUNDFLIESEN

CM	SIZE	ACABADO/FINISH	PIEZAS CAJA/ PIECES BOX	KG CAJA	M² CAJA	SQFT BOX	CAJAS/BOXES EUROPALET	M² EUROPALET	SQFT EUROPALLET	KG EUROPALET
30 x 60	12" x 24"	MATE / RÚSTICO	6	24,00	1,08	11,62	48	51,84	558,00	1179,00
30 x 60	12" x 24"	PULIDO	6	22,80	1,08	11,62	48	51,84	558,00	1121,40
60 x 60	24" x 24"	MATE / RÚSTICO	4	33,20	1,44	15,50	32	46,08	496,00	1089,40
60 x 60	24" x 24"	PULIDO	4	30,40	1,44	15,50	32	46,08	496,00	999,80

# CONCEPT

PORCELÁNICO≈PORCELAIN TILE≈GRÉS CÉRAMÉ≈FEINSTEINZEUG

DESTONIFICACIÓN INTENCIONADA≈INTENTIONALLY NON-HOMOGENEOUS COLOUR≈  
DES VARIATIONS DE NUANCES INTENTIONNÉES≈DESIGNEMÄßE ENTFÄRBUNG

## PIEZAS COMPLEMENTARIAS≈ACCESSORIES≈ACCESSOIRES ET DECORATIONS≈FORMTEILE

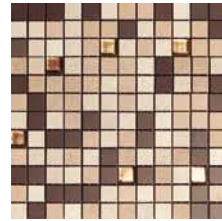

MOSAICO MIX  
CONCEPT CÁLIDO  
30 x 30 cm (12" x 12")  
P-27

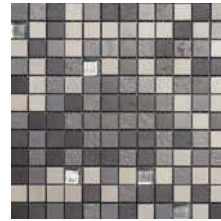

MOSAICO MIX  
CONCEPT FRÍO  
30 x 30 cm (12" x 12")  
P-27

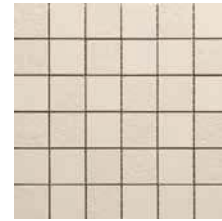

MOSAICO MIX  
CONCEPT BLANCO  
30 x 30 cm (12" x 12")  
P-11



MOSAICO MIX  
CONCEPT NEGRO  
30 x 30 cm (12" x 12")  
P-11

### PACKING LIST

COMPLEMENTOS DECORATIVOS≈DECORATIVE ACCESSORIES≈COMPLÉMENTS DE DÉCORATION≈FORMTEILE

PIEZA/PIECE	CM	SIZE	ACABADO/ FINISH	PRECIO/ PRICE	PIEZA/PIECE	CM	SIZE	ACABADO/ FINISH	PRECIO/ PRICE
Mosaico Mix Concept Calido	30x30	12" x 12"	MATE / RÚSTICO	P-27	Mosaico Mix Concept Blanco	30x30	12" x 12"	MATE / RÚSTICO	P-11
Mosaico Mix Concept Frio	30x30	12" x 12"	MATE / RÚSTICO	P-27	Mosaico Mix Concept Negro	30x30	12" x 12"	MATE / RÚSTICO	P-11

≈ Concept Negro 30x60 mate + Mosaico Mix Concept Frio + Concept Gris 30x60 mate.



## PIEZAS COMPLEMENTARIAS≈ACCESSORIES≈ACCESSOIRES ET DECORATIONS≈FORMTEILE

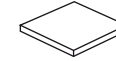

**Taco**  
*Insert*

8 x 8 cm (3,2" x 3,2")

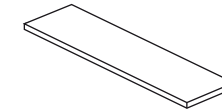

**Listel**  
*Listel*

8 x 30 cm (3,2" x 12")  
8 x 60 cm (3,2" x 24")

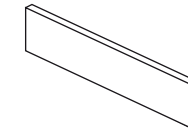

**Rodapié Cortado**  
*Straight skirting*

8 x 30 cm (3,2" x 12")  
8 x 60 cm (3,2" x 24")

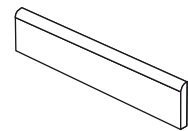

**Rodapié Canto Romo**  
*Skirting bullnose*

8 x 30 cm (3,2" x 12")  
8 x 60 cm (3,2" x 24")

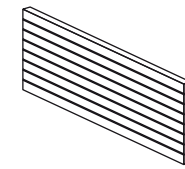

**Inciación**  
*Incision*

30 x 60 cm (12" x 24")

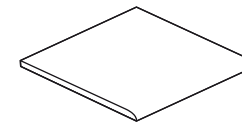

**Canto Romo**  
*Rounded edge piece*

30 x 60 cm (12" x 24")  
60 x 60 cm (24" x 24")

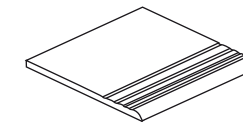

**Peldaño Ranurado**  
*Grooved stair tread*

30 x 60 cm (12" x 24")  
60 x 60 cm (24" x 24")

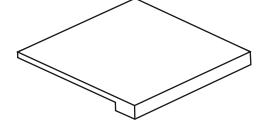

**Peldaño Elit con o sin ranura**  
*Grooved Elit Stair/Plain Elit Stair*

30 x 60 cm (12" x 24")  
60 x 60 cm (24" x 24")

### PACKING LIST

PIEZAS ESPECIALES≈SPECIAL ACCESSORIES≈ÉLÉMENTS SPÉCIAUX≈SPEZIALTEILE

PIEZA/PIECE	CM	SIZE	ACABADO/ FINISH	PRECIO/ PRICE	ACABADO/ FINISH	PRECIO/ PRICE
Taco - Insert	8x8	3,2" x 3,2"	TODOS	P-02		
Rodapié Cortado - Straight skirting	8x30	3,2" x 12"	MATE / RÚSTICO	P-02	PULIDO	P-02
Rodapié Cortado - Straight skirting	8x60	3,2" x 24"	MATE / RÚSTICO	P-04	PULIDO	P-05
Rodapié Canto Romo - Skirting bullnose	8x30	3,2" x 12"	MATE / RÚSTICO	P-03	PULIDO	P-03
Rodapié Canto Romo - Skirting bullnose	8x60	3,2" x 24"	MATE / RÚSTICO	P-05	PULIDO	P-06
Listel	8x30	3,2" x 12"	MATE / RÚSTICO	P-02	PULIDO	P-02
Listel	8x60	3,2" x 24"	MATE / RÚSTICO	P-04	PULIDO	P-05
Inciación	30x60	12" x 24"	MATE / RÚSTICO	P-12	PULIDO	P-14
Canto Romo 1 lado - Rounded edge piece 1 side	30x60	12" x 24"	MATE / RÚSTICO	P-15	PULIDO	P-17
Canto Romo 1 lado - Rounded edge piece 1 side	60x60	24" x 24"	MATE / RÚSTICO	P-28	PULIDO	P-30
Canto Romo 2 lados - Rounded edge piece 2 sides	30x60	12" x 24"	MATE / RÚSTICO	P-22	PULIDO	P-24
Canto Romo 2 lados - Rounded edge piece 2 sides	60x60	24" x 24"	MATE / RÚSTICO	P-36	PULIDO	P-38
Peldaño Ranurado - Grooved stair tread	30x60	12" x 24"	MATE / RÚSTICO	P-15	PULIDO	P-17
Peldaño Ranurado - Grooved stair tread	60x60	24" x 24"	MATE / RÚSTICO	P-28	PULIDO	P-30
Peldaño Ranurado Esquina - Grooved stair tread corner	30x60	12" x 24"	MATE / RÚSTICO	P-22	PULIDO	P-24
Peldaño Ranurado Esquina - Grooved stair tread corner	60x60	24" x 24"	MATE / RÚSTICO	P-36	PULIDO	P-38
Peldaño Elit (lado 30) - Elit step (12" side)	30x60	12" x 24"	MATE / RÚSTICO	P-27	PULIDO	P-29
Peldaño Elit (lado 60) - Elit step (24" side)	30x60	12" x 24"	MATE / RÚSTICO	P-45	PULIDO	P-47
Peldaño Elit - Elit step	60x60	24" x 24"	MATE / RÚSTICO	P-59	PULIDO	P-61
Peldaño Elit Esquina - Elit step corner	30x60	12" x 24"	MATE / RÚSTICO	P-65	PULIDO	P-68
Peldaño Elit Esquina - Elit step corner	60x60	24" x 24"	MATE / RÚSTICO	P-101	PULIDO	P-104

Estas piezas se venden por unidad, a excepción de los rodapiés que se venden en cajas de 10 uds.  
These items are sold by pieces with the exception of the skirtings which are sold by boxes of 10 pieces each.  
Unité de vente à la pièce, sauf les plinthes vendus à la boîte de 10 unités.  
Die Formteile sind pro Stück verkauft außer die Sockel, die pro Karton mit 10 Stück verkauft sind.











∞ Dolmen Beige 60x60 Esp. rústico.

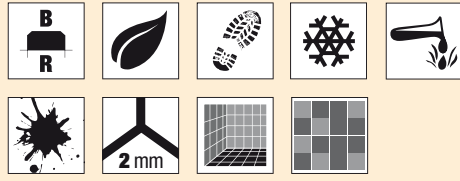

# DOLMEN

PORCELÁNICO≈PORCELAIN TILE≈GRÉS CÉRAME≈FEINSTEINZEUG

ACABADOS  
FINISHES

CARACTERÍSTICAS TÉCNICAS TECHNICAL CHARACTERISTICS	MODELOS MODELS	ACABADOS FINISHES		
		MATE	LUCIDATO	RÚSTICO
<p><b>FORMATOS≈SIZES</b></p> <p>30 x 60 cm (12" x 24") 60 x 60 cm (24" x 24") 45 x 45 cm (18" x 18") Esp. 60 x 60 cm (24" x 24") Esp.</p>  <p>Consulte página 10≈See page 10≈ Voir page 10≈Sehen Sie Seite 10</p> <p><b>ÁMBITOS DE USO≈AREA OF USE</b></p> <p><b>MATE / LUCIDATO</b> Idóneo para zonas interiores secas. <i>Suitable for dry indoor areas.</i> <i>Idéal pour application intérieure sèche.</i> <i>Ideal für trockene Innenräume.</i></p> <p><b>RÚSTICO</b> Idóneo para interiores húmedos, exteriores y piscinas. <i>Suitable for wet indoor areas, outdoor areas and swimming pools.</i> <i>Idéal pour application intérieure humide et pour extérieurs et piscines.</i> <i>Ideal für Nassbereiche, innen sowie außen und in Schwimmbädern.</i></p> <p><b>ANTI - SLIP</b> 45°</p> <p><b>NORMA≈NORM</b></p> <p>NORMA UNE-ENV 12633:2003 - Dolmen Mate: Clase 1 - Dolmen Lucidato: Clase 1 - Dolmen Rústico: Clase 3</p> <p>NORMA DIN 51130 - Dolmen Rústico: R - 12</p> <p>NORMA DIN 51097 (Pie descalzo) - Dolmen Rústico: Grupo C</p>	<p>BEIGE</p> 			
	<p>NACAR</p> 			
	<p>GRIS</p> 			
	<p>GRAFITO</p> 			

Detalle a escala 1:1 ≈ Detail scale 1:1 ≈ Detail échelle 1:1 ≈ Maßstab 1:1

	MATE	LUCIDATO	RÚSTICO
BEIGE	●	●	●
NACAR	●	●	●
GRIS	●	●	●
GRAFITO	●	●	●

# DOLMEN

PORCELÁNICO~PORCELAIN TILE~GRÉS CÉRAME~FEINSTEINZEUG

∞ Dolmen Gris 60x60 rústico.



# DOLMEN

PORCELÁNICO~PORCELAIN TILE~GRÉS CÉRAME~FEINSTEINZEUG

≈ Dolmen Nacar 45x45 Esp. rústico.



# DOLMEN

PORCELÁNICO≈PORCELAIN TILE≈GRÉS CÉRAMÉ≈FEINSTEINZEUG

DESTONIFICACIÓN INTENCIONADA≈INTENTIONALLY NON-HOMOGENEOUS COLOUR≈  
DES VARIATIONS DE NUANCES INTENTIONNÉES≈DESIGNGEMÄßE ENTFÄRBUNG

## D12 BEIGE ≈

30x60 cm. (12x24") · MATE



ACABADOS / FINISHES

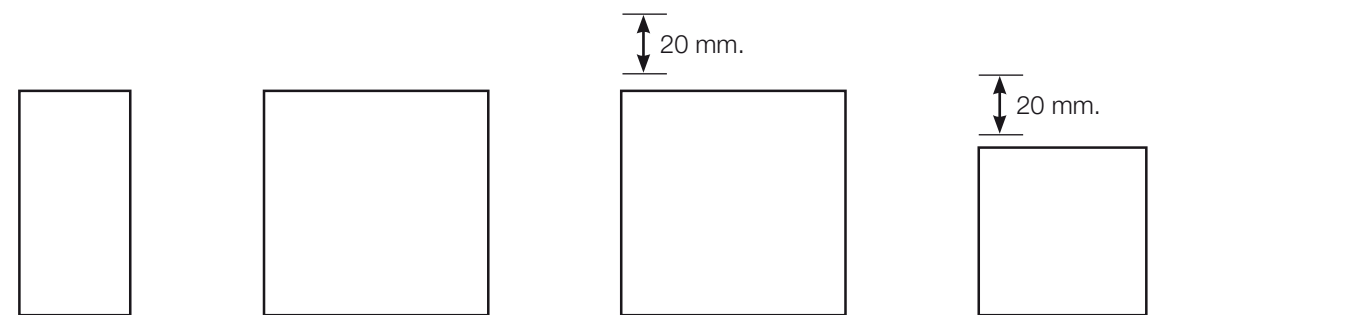

Mate B-45 Lucidato B-52 Rústico B-45 30 x 60 cm (12" x 24")	Mate B-51 Lucidato B-58 Rústico B-51 60 x 60 cm (24" x 24")	Esp. Rústico B-105 60 x 60 cm (24" x 24")	Esp. Rústico B-85 45 x 45 cm (18" x 18")
---	---	---	--

### PACKING LIST

PIEZAS BASE≈BASIC TILES≈ÉLÉMENTS DE BASE≈GRUNDFLIESEN

CM	SIZE	ACABADO/FINISH	PIEZAS CAJA/ PIECES BOX	KG CAJA	M² CAJA	SQFT BOX	CAJAS/BOXES EUROPALET	M² EUROPALET	SQFT EUROPALET	KG EUROPALET
30 x 60	12" x 24"	TODOS	6	24,00	1,08	11,62	48	51,84	558,00	1179,00
45 x 45	18" x 18"	ESP RÚSTICO	2	18,80	0,405	4,36	39	15,79	170,02	760,20
60 x 60	24" x 24"	TODOS	4	33,20	1,44	15,50	32	46,08	496,00	1089,40
60 x 60	24" x 24"	ESP RÚSTICO	2	34,00	0,720	7,75	30	21,60	232,50	1.047,00

## D15 NACAR ≈

30x60 cm. (12x24") · MATE



ACABADOS / FINISHES

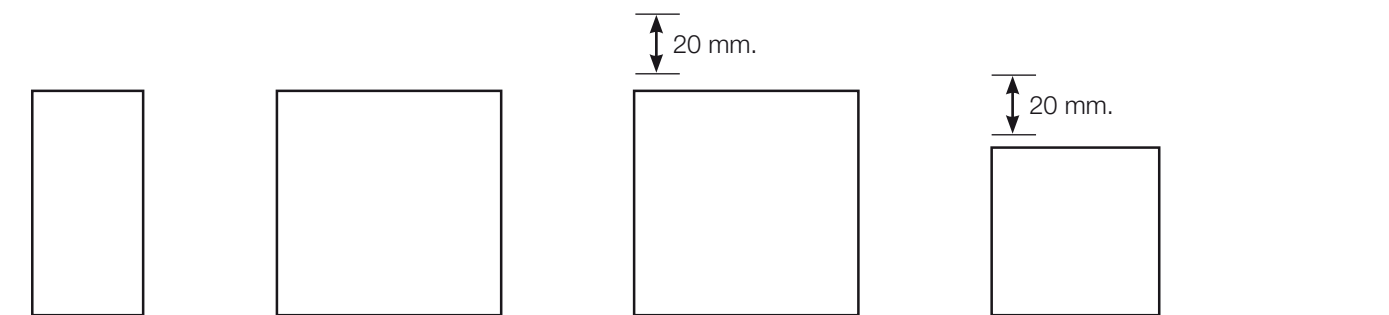

Mate B-45 Lucidato B-52 Rústico B-45 30 x 60 cm (12" x 24")	Mate B-51 Lucidato B-58 Rústico B-51 60 x 60 cm (24" x 24")	Esp. Rústico B-105 60 x 60 cm (24" x 24")	Esp. Rústico B-85 45 x 45 cm (18" x 18")
---	---	---	--

### PACKING LIST

PIEZAS BASE≈BASIC TILES≈ÉLÉMENTS DE BASE≈GRUNDFLIESEN

CM	SIZE	ACABADO/FINISH	PIEZAS CAJA/ PIECES BOX	KG CAJA	M² CAJA	SQFT BOX	CAJAS/BOXES EUROPALET	M² EUROPALET	SQFT EUROPALET	KG EUROPALET
30 x 60	12" x 24"	TODOS	6	24,00	1,08	11,62	48	51,84	558,00	1179,00
45 x 45	18" x 18"	ESP RÚSTICO	2	18,80	0,405	4,36	39	15,79	170,02	760,20
60 x 60	24" x 24"	TODOS	4	33,20	1,44	15,50	32	46,08	496,00	1089,40
60 x 60	24" x 24"	ESP RÚSTICO	2	34,00	0,720	7,75	30	21,60	232,50	1.047,00

# DOLMEN

PORCELÁNICO≈PORCELAIN TILE≈GRÉS CÉRAMÉ≈FEINSTEINZEUG

DESTONIFICACIÓN INTENCIONADA≈INTENTIONALLY NON-HOMOGENEOUS COLOUR≈  
DES VARIATIONS DE NUANCES INTENTIONNÉES≈DESIGNGEMÄÙE ENTFÄRBUNG

## D11 GRIS ≈

30x60 cm. (12x24") · MATE



### ACABADOS / FINISHES

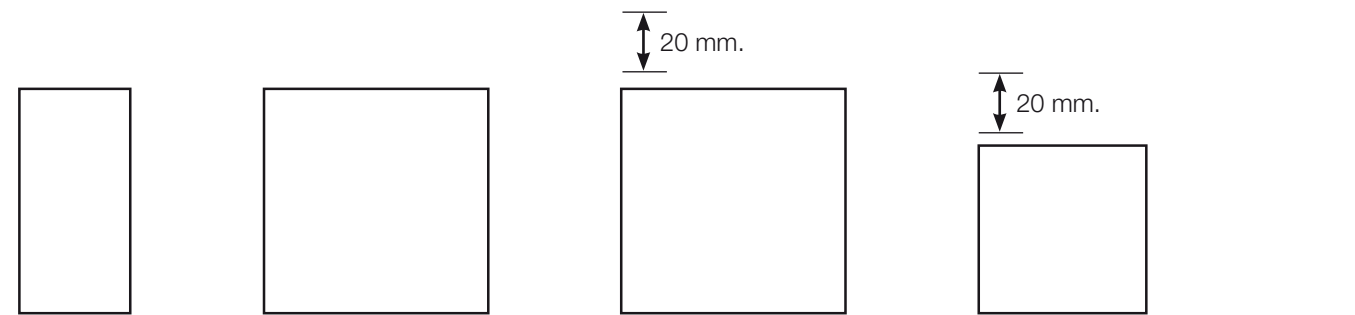

Mate B-45 Lucidato B-52 Rústico B-45 30 x 60 cm (12" x 24")	Mate B-51 Lucidato B-58 Rústico B-51 60 x 60 cm (24" x 24")	Esp. Rústico B-105 60 x 60 cm (24" x 24")	Esp. Rústico B-85 45 x 45 cm (18" x 18")
---	---	---	--

### PACKING LIST

PIEZAS BASE≈BASIC TILES≈ELÉMENTS DE BASE≈GRUNDFLIESEN

CM	SIZE	ACABADO/FINISH	PIEZAS CAJA/ PIECES BOX	KG CAJA	M² CAJA	SQFT BOX	CAJAS/BOXES EUROPALET	M² EUROPALET	SQFT EUROPALET	KG EUROPALET
30 x 60	12" x 24"	TODOS	6	24,00	1,08	11,62	48	51,84	558,00	1179,00
45 x 45	18" x 18"	ESP RÚSTICO	2	18,80	0,405	4,36	39	15,79	170,02	760,20
60 x 60	24" x 24"	TODOS	4	33,20	1,44	15,50	32	46,08	496,00	1089,40
60 x 60	24" x 24"	ESP RÚSTICO	2	34,00	0,720	7,75	30	21,60	232,50	1.047,00

## D14 GRAFITO ≈

30x60 cm. (12x24") · MATE



### ACABADOS / FINISHES

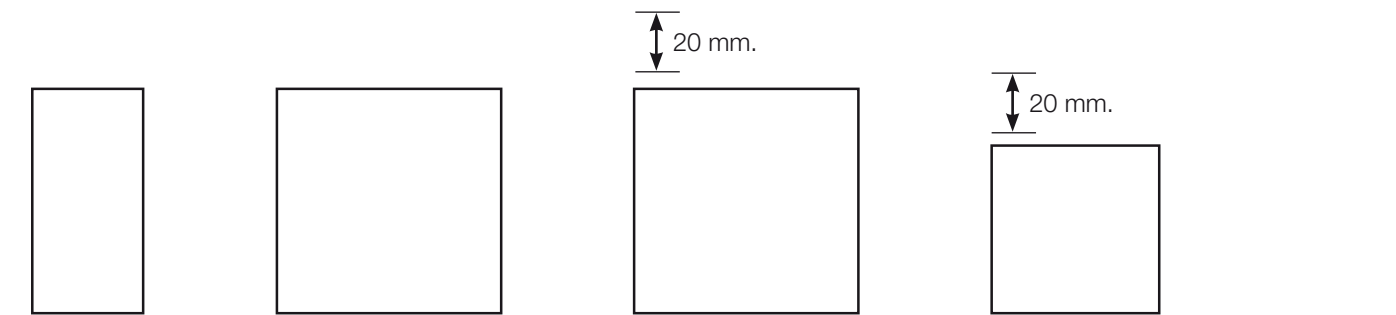

Mate B-45 Lucidato B-52 Rústico B-45 30 x 60 cm (12" x 24")	Mate B-51 Lucidato B-58 Rústico B-51 60 x 60 cm (24" x 24")	Esp. Rústico B-105 60 x 60 cm (24" x 24")	Esp. Rústico B-85 45 x 45 cm (18" x 18")
---	---	---	--

### PACKING LIST

PIEZAS BASE≈BASIC TILES≈ELÉMENTS DE BASE≈GRUNDFLIESEN

CM	SIZE	ACABADO/FINISH	PIEZAS CAJA/ PIECES BOX	KG CAJA	M² CAJA	SQFT BOX	CAJAS/BOXES EUROPALET	M² EUROPALET	SQFT EUROPALET	KG EUROPALET
30 x 60	12" x 24"	TODOS	6	24,00	1,08	11,62	48	51,84	558,00	1179,00
45 x 45	18" x 18"	ESP RÚSTICO	2	18,80	0,405	4,36	39	15,79	170,02	760,20
60 x 60	24" x 24"	TODOS	4	33,20	1,44	15,50	32	46,08	496,00	1089,40
60 x 60	24" x 24"	ESP RÚSTICO	2	34,00	0,720	7,75	30	21,60	232,50	1.047,00

≈ Dolmen Beige 60x60 lucidato.

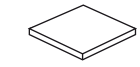
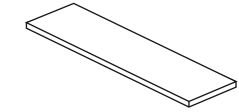
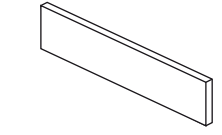
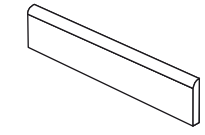
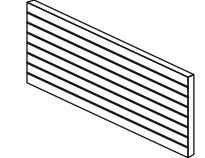
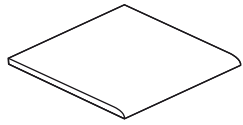
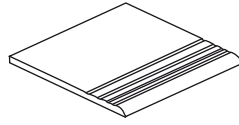
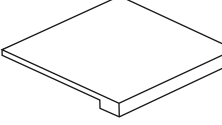
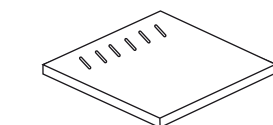
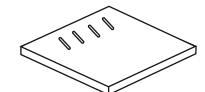

## PIEZAS COMPLEMENTARIAS≈ACCESSORIES≈ACCESSOIRES ET DECORATIONS≈FORMTEILE

				
<b>Taco</b> <i>Insert</i> 8 x 8 cm (3,2" x 3,2")	<b>Listel</b> <i>Listel</i> 8 x 30 cm (3,2" x 12") 8 x 45 cm (3,2" x 18") 8 x 60 cm (3,2" x 24")	<b>Rodapié Cortado</b> <i>Straight skirting</i> 8 x 30 cm (3,2" x 12") 8 x 45 cm (3,2" x 18") 8 x 60 cm (3,2" x 24")	<b>Rodapié Canto Romo</b> <i>Skirting bullnose</i> 8 x 30 cm (3,2" x 12") 8 x 45 cm (3,2" x 18") 8 x 60 cm (3,2" x 24")	<b>Incisión</b> <i>Incision</i> 30 x 60 cm (12" x 24")
				
<b>Canto Romo</b> <i>Rounded edge piece</i> 30 x 60 cm (12" x 24") 45 x 45 cm (18" x 18") 60 x 60 cm (24" x 24")	<b>Peldaño Ranurado</b> <i>Grooved stair tread</i> 30 x 60 cm (12" x 24") 45 x 45 cm (18" x 18") 60 x 60 cm (24" x 24")	<b>Peldaño Elit con o sin ranura</b> <i>Grooved Elit Stair/Plain Elit Stair</i> 30 x 60 cm (12" x 24") 45 x 45 cm (18" x 18") 60 x 60 cm (24" x 24")	<b>Rejilla 20 mm.</b> <i>Grating 20 mm.</i> 60 x 60 cm (24" x 24")	<b>Rejilla 20 mm.</b> <i>Grating 20 mm.</i> 45 x 45 cm (18" x 18")

## PACKING LIST

PIEZAS ESPECIALES≈SPECIAL ACCESSORIES≈ÉLÉMENTS SPÉCIAUX≈SPEZIALTEILE

PIEZA/PIECE	CM	SIZE	ACABADO/ FINISH	PRECIO/ PRICE	PIEZA/PIECE	CM	SIZE	ACABADO/ FINISH	PRECIO/ PRICE
Taco - Insert	8x8	3,2" x 3,2"	TODOS	P-02	Canto Romo 2 lados - Rounded edge piece 2 sides	60x60	24" x 24"	TODOS	P-35
Rodapié Cortado - Straight skirting	8x30	3,2" x 12"	TODOS	P-02	Peldaño Ranurado - Grooved stair tread	30x60	12" x 24"	TODOS	P-17
Rodapié Cortado - Straight skirting	8x60	3,2" x 24"	TODOS	P-05	Peldaño Ranurado - Grooved stair tread	60x60	24" x 24"	TODOS	P-28
Rodapié Canto Romo - Skirting bullnose	8x30	3,2" x 12"	TODOS	P-03	Peldaño Ranurado Esquina - Grooved stair tread corner	30x60	12" x 24"	TODOS	P-23
Rodapié Canto Romo - Skirting bullnose	8x60	3,2" x 24"	TODOS	P-06	Peldaño Ranurado Esquina - Grooved stair tread corner	60x60	24" x 24"	TODOS	P-35
Listel	8x30	3,2" x 12"	TODOS	P-02	Peldaño Elit (lado 30) - Elit step (12" side)	30x60	12" x 24"	TODOS	P-29
Listel	8x60	3,2" x 24"	TODOS	P-05	Peldaño Elit (lado 60) - Elit step (24" side)	30x60	12" x 24"	TODOS	P-47
Incisión	30x60	12" x 24"	TODOS	P-13	Peldaño Elit - Elit step	60x60	24" x 24"	TODOS	P-59
Canto Romo 1 lado - Rounded edge piece 1 side	30x60	12" x 24"	TODOS	P-17	Peldaño Elit Esquina - Elit step corner	30x60	12" x 24"	TODOS	P-67
Canto Romo 1 lado - Rounded edge piece 1 side	60x60	24" x 24"	TODOS	P-28	Peldaño Elit Esquina - Elit step corner	60x60	24" x 24"	TODOS	P-100
Canto Romo 2 lados - Rounded edge piece 2 sides	30x60	12" x 24"	TODOS	P-23					

## ESPESORADO

Taco - Insert	8x8	3,2" x 3,2"	RÚSTICO	P-02	Peldaño Ranurado - Grooved stair tread	45x45	18" x 18"	RÚSTICO	P-22
Rodapié Cortado - Straight skirting	8x45	3,2" x 18"	RÚSTICO	P-04	Peldaño Ranurado - Grooved stair tread	60x60	24" x 24"	RÚSTICO	P-40
Rodapié Cortado - Straight skirting	8x60	3,2" x 24"	RÚSTICO	P-06	Peldaño Ranurado Esquina - Grooved stair tread corner	45x45	18" x 18"	RÚSTICO	P-27
Rodapié Canto Romo - Skirting bullnose	8x45	3,2" x 18"	RÚSTICO	P-05	Peldaño Ranurado Esquina - Grooved stair tread corner	60x60	24" x 24"	RÚSTICO	P-47
Rodapié Canto Romo - Skirting bullnose	8x60	3,2" x 24"	RÚSTICO	P-09	Peldaño Elit - Elit step	45x45	18" x 18"	RÚSTICO	P-50
Listel	8x45	3,2" x 18"	RÚSTICO	P-04	Peldaño Elit - Elit step	60x60	24" x 24"	RÚSTICO	P-85
Listel	8x60	3,2" x 24"	RÚSTICO	P-06	Peldaño Elit Esquina - Elit step corner	45x45	18" x 18"	RÚSTICO	P-79
Canto Romo 1 lado - Rounded edge piece 1 side	45x45	18" x 18"	RÚSTICO	P-22	Peldaño Elit Esquina - Elit step corner	60x60	24" x 24"	RÚSTICO	P-132
Canto Romo 1 lado - Rounded edge piece 1 side	60x60	24" x 24"	RÚSTICO	P-40	Rejilla - Grating	45x45	18" x 18"	RÚSTICO	P-55
Canto Romo 2 lados - Rounded edge piece 2 sides	45x45	18" x 18"	RÚSTICO	P-27	Rejilla - Grating	60x60	24" x 24"	RÚSTICO	P-63
Canto Romo 2 lados - Rounded edge piece 2 sides	60x60	24" x 24"	RÚSTICO	P-47					

Estas piezas se venden por unidad, a excepción de los rodapiés que se venden en cajas de 10 uds. (espesorado: 5 uds/caja).  
These items are sold by pieces with the exception of the skirtings which are sold by boxes of 10 pieces each (special thickness 5 pcs/box).  
Unité de vente à la pièce, sauf les plinthes vendus à la boîte de 10 unités (É paisseurs 5 pièce/boîte).  
Die Formteile sind pro Stück verkauft außer die Sockel, die pro Karton mit 10 Stück verkauft sind (Spezialdicke 5 Stück pro Karton).

≈ Ironwood Fresno 60x60 Esp. natural.









# IRONWOOD





PORCELÁNICO≈PORCELAIN TILE≈GRÉS CÉRAME≈FEINSTEINZEUG

ACABADOS FINISHES

**CARACTERÍSTICAS TÉCNICAS**  
TECHNICAL CHARACTERISTICS

**FORMATOS≈SIZES**  
15 x 90 cm (6" x 36")  
22,5 x 90 cm (9" x 36")  
60 x 60 cm (24" x 24") Esp.

Consulte página 10≈See page 10≈  
Voir page 10≈Sehen Sie Seite 10

**ÁMBITOS DE USO≈AREA OF USE**

**NATURAL**  
Recomendado para interiores secos, húmedos, exteriores y piscinas.  
*Suitable for dry and wet indoor areas, outdoor areas and swimming pools.*  
*Idéal pour application intérieure sèche ainsi que humide et pour extérieurs et piscines.*  
*Ideal für trockene Innenräume, Nassbereiche, innen sowie außen und in Schwimmbädern.*

**LUCIDATO**  
Idóneo para zonas interiores secas.  
*Suitable for dry indoor areas.*  
*Idéal pour application intérieure sèche.*  
*Ideal für trockene Innenräume.*

**NORMA≈NORM**

NORMA UNE-ENV 12633:2003  
- Ironwood Natural: Clase 3  
- Ironwood Lucidato: Clase 1

NORMA DIN 51130  
- Ironwood Natural 15 x 90 & 22,5 x 90: R-11  
- Ironwood Natural 60 x 60 Esp.: R-12

NORMA DIN 51097 (Pie descalzo)  
- Ironwood Natural 60 x 60 Esp.: Grupo C

**MODELOS MODELS**

ABETO

FRESNO

BAMBÚ

OLIVO

CIPRÉS

ÉBANO

≡ NATURAL ≡
≡ LUCIDATO ≡



Detalle a escala 1:1 ≈ Detail scale 1:1 ≈ Detail échelle 1:1 ≈ Maßstab 1:1

	NATURAL	LUCIDATO
ABETO	●	●
FRESNO	●	●
BAMBÚ	●	●
OLIVO	●	●
CIPRÉS	●	●
ÉBANO	●	●

# IRONWOOD

PORCELÁNICO~PORCELAIN TILE~GRÉS CÉRAME~FEINSTEINZEUG

≈ Ironwood Bambú 15x90 + 22,5x90 natural + Ironwood Olivo 15x90 natural.



# IRONWOOD

PORCELÁNICO~PORCELAIN TILE~GRÉS CÉRAME~FEINSTEINZEUG

∞ Ironwood Fresno 22,5x90 natural.



# IRONWOOD

PORCELÁNICO~PORCELAIN TILE~GRÉS CÉRAME~FEINSTEINZEUG

≡ Ironwood Ciprés 15x90 natural.



# IRONWOOD

PORCELÁNICO≈PORCELAIN TILE≈GRÉS CÉRAMÉ≈FEINSTEINZEUG

DESTONIFICACIÓN INTENCIONADA≈INTENTIONALLY NON-HOMOGENEOUS COLOUR≈  
DES VARIATIONS DE NUANCES INTENTIONNÉES≈DESIGNGEMÄßE ENTFÄRBUNG

≈ Ironwood Abeto 15x90 natural.



## W11 ABETO ≈

15x90 cm. (6x36") · NATURAL



22,5x90 cm. (9x36") · NATURAL



## ACABADOS / FINISHES



NATURAL



LUCIDATO

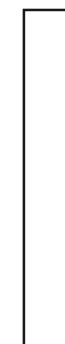

Natural B-66  
Lucidato B-74  
15 x 90 cm  
(6" x 36")

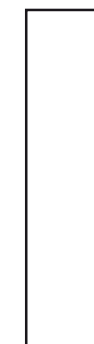

Natural B-61  
Lucidato B-69  
22,5 x 90 cm  
(9" x 36")

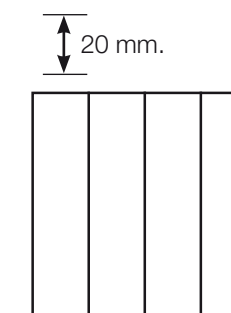

Esp. Natural B-110  
60 x 60 cm  
(24" x 24")

## PACKING LIST

PIEZAS BASE≈BASIC TILES≈ÉLÉMENTS DE BASE≈GRUNDFLIESEN

CM	SIZE	ACABADO/FINISH	PIEZAS CAJA/ PIECES BOX	KG CAJA	M² CAJA	SQFT BOX	CAJAS/BOXES EUROPALET	M² EUROPALET	SQFT EUROPALET	KG EUROPALET
15 x 90	6" x 36"	TODOS	6	20,10	0,81	8,72	48	38,88	418,56	991,80
22,5 x 90	9" x 36"	TODOS	4	20,40	0,81	8,72	42	34,02	366,19	883,80
60 x 60	24" x 24"	ESP NATURAL	2	34,00	0,720	7,75	30	21,60	232,50	1.047,00

# IRONWOOD

PORCELÁNICO≈PORCELAIN TILE≈GRÉS CÉRAMÉ≈FEINSTEINZEUG

DESTONIFICACIÓN INTENCIONADA≈INTENTIONALLY NON-HOMOGENEOUS COLOUR≈  
DES VARIATIONS DE NUANCES INTENTIONNÉES≈DESIGNGEMÄßE ENTFÄRBUNG

## W12 FRESNO ≡

15x90 cm. (6x36") · NATURAL



22,5x90 cm. (9x36") · NATURAL



### ACABADOS / FINISHES

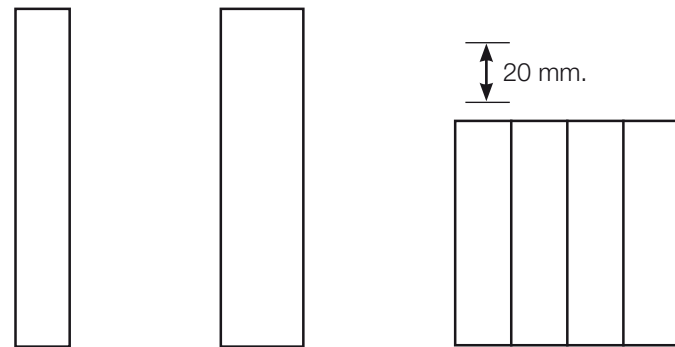

Natural B-66 Lucidato B-74 15 x 90 cm (6" x 36")	Natural B-61 Lucidato B-69 22,5 x 90 cm (9" x 36")	Esp. Natural B-110 60 x 60 cm (24" x 24")
---	---	---

### PACKING LIST

PIEZAS BASE≈BASIC TILES≈ELÉMENTS DE BASE≈GRUNDFLIESEN

CM	SIZE	ACABADO/FINISH	PIEZAS CAJA/ PIECES BOX	KG CAJA	M² CAJA	SQFT BOX	CAJAS/BOXES EUROPALET	M² EUROPALET	SQFT EUROPALLET	KG EUROPALET
15 x 90	6" x 36"	TODOS	6	20,10	0,81	8,72	48	38,88	418,56	991,80
22,5 x 90	9" x 36"	TODOS	4	20,40	0,81	8,72	42	34,02	366,19	883,80
60 x 60	24" x 24"	ESP NATURAL	2	34,00	0,720	7,75	30	21,60	232,50	1.047,00

## W13 BAMBÚ ≡

15x90 cm. (6x36") · NATURAL



22,5x90 cm. (9x36") · NATURAL



### ACABADOS / FINISHES

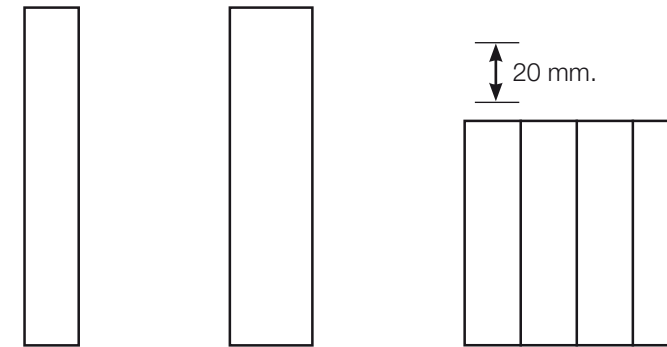

Natural B-66 Lucidato B-74 15 x 90 cm (6" x 36")	Natural B-61 Lucidato B-69 22,5 x 90 cm (9" x 36")	Esp. Natural B-110 60 x 60 cm (24" x 24")
---	---	---

### PACKING LIST

PIEZAS BASE≈BASIC TILES≈ELÉMENTS DE BASE≈GRUNDFLIESEN

CM	SIZE	ACABADO/FINISH	PIEZAS CAJA/ PIECES BOX	KG CAJA	M² CAJA	SQFT BOX	CAJAS/BOXES EUROPALET	M² EUROPALET	SQFT EUROPALLET	KG EUROPALET
15 x 90	6" x 36"	TODOS	6	20,10	0,81	8,72	48	38,88	418,56	991,80
22,5 x 90	9" x 36"	TODOS	4	20,40	0,81	8,72	42	34,02	366,19	883,80
60 x 60	24" x 24"	ESP NATURAL	2	34,00	0,720	7,75	30	21,60	232,50	1.047,00

# IRONWOOD

PORCELÁNICO≈PORCELAIN TILE≈GRÉS CÉRAME≈FEINSTEINZEUG

DESTONIFICACIÓN INTENCIONADA≈INTENTIONALLY NON-HOMOGENEOUS COLOUR≈  
DES VARIATIONS DE NUANCES INTENTIONNÉES≈DESIGNGEMÄÙE ENTFÄRBUNG

## W14 OLIVO ≈

15x90 cm. (6x36") · NATURAL



22,5x90 cm. (9x36") · NATURAL



### ACABADOS / FINISHES

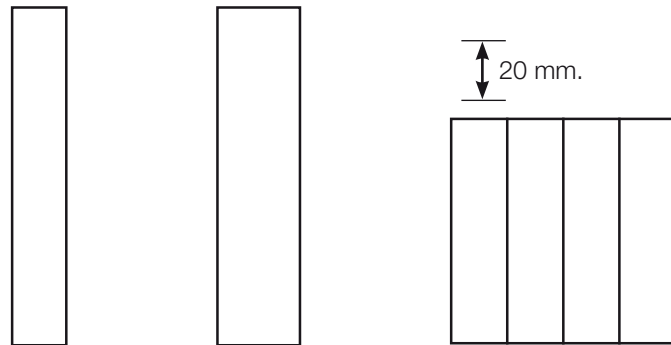
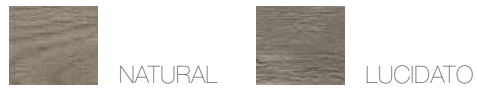

Natural B-66 Lucidato B-74 15 x 90 cm (6" x 36")	Natural B-61 Lucidato B-69 22,5 x 90 cm (9" x 36")	Esp. Natural B-110 60 x 60 cm (24" x 24")
---	---	---

### PACKING LIST

PIEZAS BASE≈BASIC TILES≈ELÉMENTS DE BASE≈GRUNDFLIESEN

CM	SIZE	ACABADO/FINISH	PIEZAS CAJA/ PIECES BOX	KG CAJA	M² CAJA	SQFT BOX	CAJAS/BOXES EUROPALET	M² EUROPALET	SQFT EUROPALLET	KG EUROPALET
15 x 90	6" x 36"	TODOS	6	20,10	0,81	8,72	48	38,88	418,56	991,80
22,5 x 90	9" x 36"	TODOS	4	20,40	0,81	8,72	42	34,02	366,19	883,80
60 x 60	24" x 24"	ESP NATURAL	2	34,00	0,720	7,75	30	21,60	232,50	1.047,00

## W15 CIPRÉS ≈

15x90 cm. (6x36") · NATURAL



22,5x90 cm. (9x36") · NATURAL



### ACABADOS / FINISHES

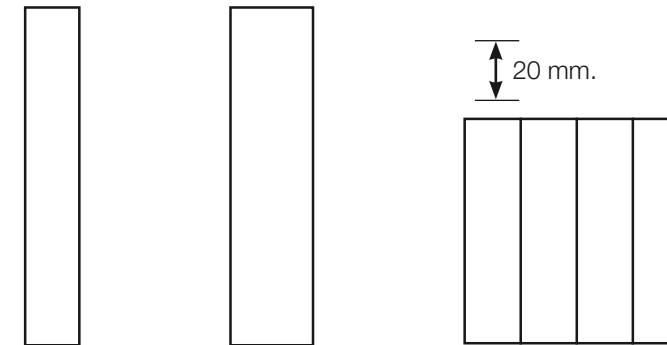

Natural B-66 Lucidato B-74 15 x 90 cm (6" x 36")	Natural B-61 Lucidato B-69 22,5 x 90 cm (9" x 36")	Esp. Natural B-110 60 x 60 cm (24" x 24")
---	---	---

### PACKING LIST

PIEZAS BASE≈BASIC TILES≈ELÉMENTS DE BASE≈GRUNDFLIESEN

CM	SIZE	ACABADO/FINISH	PIEZAS CAJA/ PIECES BOX	KG CAJA	M² CAJA	SQFT BOX	CAJAS/BOXES EUROPALET	M² EUROPALET	SQFT EUROPALLET	KG EUROPALET
15 x 90	6" x 36"	TODOS	6	20,10	0,81	8,72	48	38,88	418,56	991,80
22,5 x 90	9" x 36"	TODOS	4	20,40	0,81	8,72	42	34,02	366,19	883,80
60 x 60	24" x 24"	ESP NATURAL	2	34,00	0,720	7,75	30	21,60	232,50	1.047,00

# IRONWOOD

PORCELÁNICO≈PORCELAIN TILE≈GRÉS CÉRAMÉ≈FEINSTEINZEUG

DESTONIFICACIÓN INTENCIONADA≈INTENTIONALLY NON-HOMOGENEOUS COLOUR≈  
DES VARIATIONS DE NUANCES INTENTIONNÉES≈DESIGNEMÄßE ENTFÄRBUNG

## W16 ÉBANO ≈

15x90 cm. (6x36") · NATURAL



22,5x90 cm. (9x36") · NATURAL



## ACABADOS / FINISHES

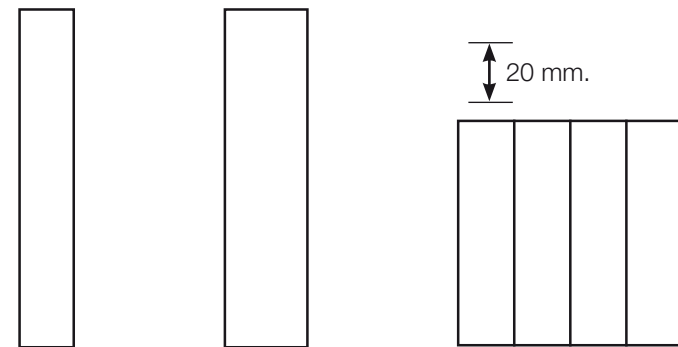

Natural B-66  
Lucidato B-74  
15 x 90 cm  
(6" x 36")

Natural B-61  
Lucidato B-69  
22,5 x 90 cm  
(9" x 36")

Esp. Natural B-110  
60 x 60 cm  
(24" x 24")

## PACKING LIST

PIEZAS BASE≈BASIC TILES≈ELÉMENTS DE BASE≈GRUNDFLIESEN

CM	SIZE	ACABADO/FINISH	PIEZAS CAJA/ PIECES BOX	KG CAJA	M² CAJA	SQFT BOX	CAJAS/BOXES EUROPALET	M² EUROPALET	SQFT EUROPALLET	KG EUROPALET
15 x 90	6" x 36"	TODOS	6	20,10	0,81	8,72	48	38,88	418,56	991,80
22,5 x 90	9" x 36"	TODOS	4	20,40	0,81	8,72	42	34,02	366,19	883,80
60 x 60	24" x 24"	ESP NATURAL	2	34,00	0,720	7,75	30	21,60	232,50	1.047,00

## PIEZAS COMPLEMENTARIAS≈ACCESSORIES≈ACCESSOIRES ET DECORATIONS≈FORMTEILE

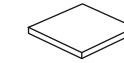

**Taco**  
Insert  
8 x 8 cm (3,2" x 3,2")

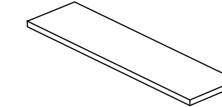

**Listel**  
Listel  
8 x 45 cm (3,2" x 18")  
8 x 90 cm (3,2" x 36")

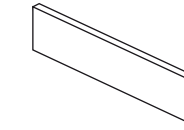

**Rodapié Cortado**  
Straight skirting  
8 x 45 cm (3,2" x 18")  
8 x 90 cm (3,2" x 36")

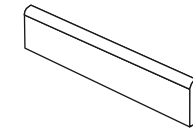

**Rodapié Canto Romo**  
Skirting bullnose  
8 x 45 cm (3,2" x 18")  
8 x 90 cm (3,2" x 36")

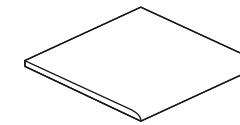

**Canto Romo**  
Rounded edge piece  
45 x 90 cm (18" x 36")

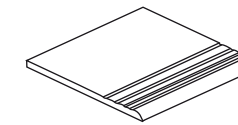

**Peldaño Ranurado**  
Grooved stair tread  
45 x 90 cm (18" x 36")

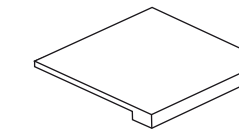

**Peldaño Elit con o sin ranura**  
Grooved Elit Stair/Plain Elit Stair  
45 x 90 cm (18" x 36")

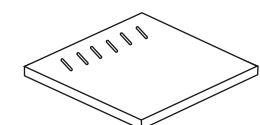

**Rejilla 20 mm.**  
Grating 20 mm.  
60 x 60 cm (24" x 24")

## PACKING LIST

PIEZAS ESPECIALES≈SPECIAL ACCESSORIES≈ELÉMENTS SPÉCIAUX≈SPEZIALTEILE

PIEZA/PIECE	CM	SIZE	ACABADO/ FINISH	PRECIO/ PRICE	PIEZA/PIECE	CM	SIZE	ACABADO/ FINISH	PRECIO/ PRICE
Taco - Insert	8x8	3,2" x 3,2"	TODOS	P-02	Canto Romo 1 lado - Rounded edge piece 1 side	45x90	18" x 36"	TODOS	P-35
Rodapié Cortado - Straight skirting	8x45	3,2" x 18"	TODOS	P-04	Canto Romo 2 lados - Rounded edge piece 2 sides	45x90	18" x 36"	TODOS	P-45
Rodapié Cortado - Straight skirting	8x90	3,2" x 36"	TODOS	P-08	Peldaño Ranurado - Grooved stair tread	45x90	18" x 36"	TODOS	P-35
Rodapié Canto Romo - Skirting bullnose	8x45	3,2" x 18"	TODOS	P-05	Peldaño Ranurado Esquina - Grooved stair tread corner	45x90	18" x 36"	TODOS	P-45
Rodapié Canto Romo - Skirting bullnose	8x90	3,2" x 36"	TODOS	P-10	Peldaño Elit (lado 45) - Elit step (18" side)	45x90	18" x 36"	TODOS	P-54
Listel	8x45	3,2" x 18"	TODOS	P-04	Peldaño Elit (lado 90) - Elit step (36" side)	45x90	18" x 36"	TODOS	P-81
Listel	8x90	3,2" x 36"	TODOS	P-08	Peldaño Elit Esquina - Elit step corner	45x90	18" x 36"	TODOS	P-114

## ESPESORADO

Taco - Insert	8x8	3,2" x 3,2"	RÚSTICO	P-02	Peldaño Ranurado - Grooved stair tread	60x60	24" x 24"	RÚSTICO	P-40
Rodapié Cortado - Straight skirting	8x60	3,2" x 24"	RÚSTICO	P-06	Peldaño Ranurado Esquina - Grooved stair tread corner	60x60	24" x 24"	RÚSTICO	P-47
Rodapié Canto Romo - Skirting bullnose	8x60	3,2" x 24"	RÚSTICO	P-09	Peldaño Elit - Elit step	60x60	24" x 24"	RÚSTICO	P-85
Listel	8x60	3,2" x 24"	RÚSTICO	P-06	Peldaño Elit Esquina - Elit step corner	60x60	24" x 24"	RÚSTICO	P-132
Canto Romo 1 lado - Rounded edge piece 1 side	60x60	24" x 24"	RÚSTICO	P-40	Rejilla - Grating	60x60	24" x 24"	RÚSTICO	P-63
Canto Romo 2 lados - Rounded edge piece 2 sides	60x60	24" x 24"	RÚSTICO	P-47					

Estas piezas se venden por unidad, a excepción de los rodapiés que se venden en cajas de 10 uds. (espesorado: 5 uds/caja).  
These items are sold by pieces with the exception of the skirtings which are sold by boxes of 10 pieces each (special thickness 5 pcs/box).  
Unité de vente à la pièce, sauf les plinthes vendus à la boîte de 10 unités (É paisseurs 5 pièce/boîte).  
Die Formteile sind pro Stück verkauft außer die Sockel, die pro Karton mit 10 Stück verkauft sind (Spetialdicke 5 stück pro Karton).



≈ Legno Beige 15x90 natural + Legno Bianco 15x90 natural.



## CARACTERÍSTICAS TÉCNICAS TECHNICAL CHARACTERISTICS

### FORMATOS~SIZES

15 x 90 cm (6" x 36")  
22,5 x 90 cm (9" x 36")

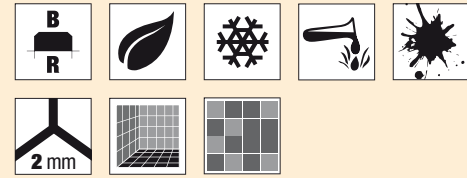

Consulte página 10~See page 10~  
Voir page 10~Sehen Sie Seite 10

### ÁMBITOS DE USO~AREA OF USE

#### NATURAL

Idóneo para zonas interiores secas.  
*Suitable for dry indoor areas.*  
*Idéal pour application intérieure sèche.*  
*Ideal für trockene Innenräume.*

### NORMA~NORM

NORMA UNE-ENV 12633:2003  
- Legno Natural: Clase 1

## MODELOS MODELS

≡  
BEIGE

≡  
BIANCO

≡  
GRIGIO

≡  
SCURO



≡ NATURAL ≡



Detalle a escala 1:1 ~ Detail scale 1:1 ~ Detail échelle 1:1 ~ Maßstab 1:1

	MATE
BEIGE	●
BIANCO	●
GRIGIO	●
SCURO	●

# LEGNO

PORCELÁNICO~PORCELAIN TILE~GRÉS CÉRAME~FEINSTEINZEUG

∞ Legno Beige 15x90 natural + Legno Bianco 15x90 natural.



# LEGNO

PORCELÁNICO~PORCELAIN TILE~GRÉS CÉRAME~FEINSTEINZEUG

≈ Legno Scuro 22,5x90 + 15x90 natural + Legno Bianco 22,5x90 + 15x90 natural.

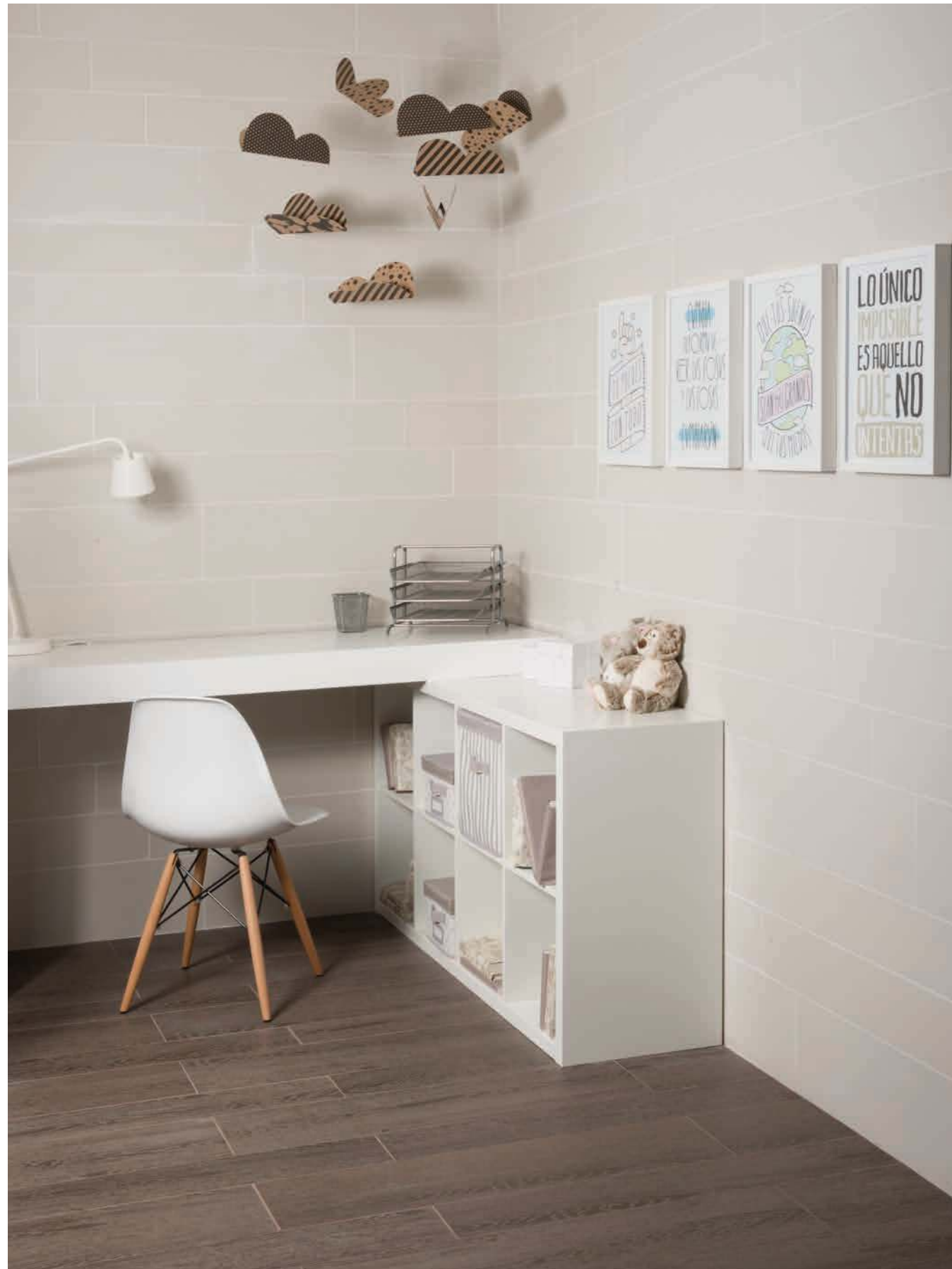

≈ Legno Grigio 15x90 + 22,5x90 natural.

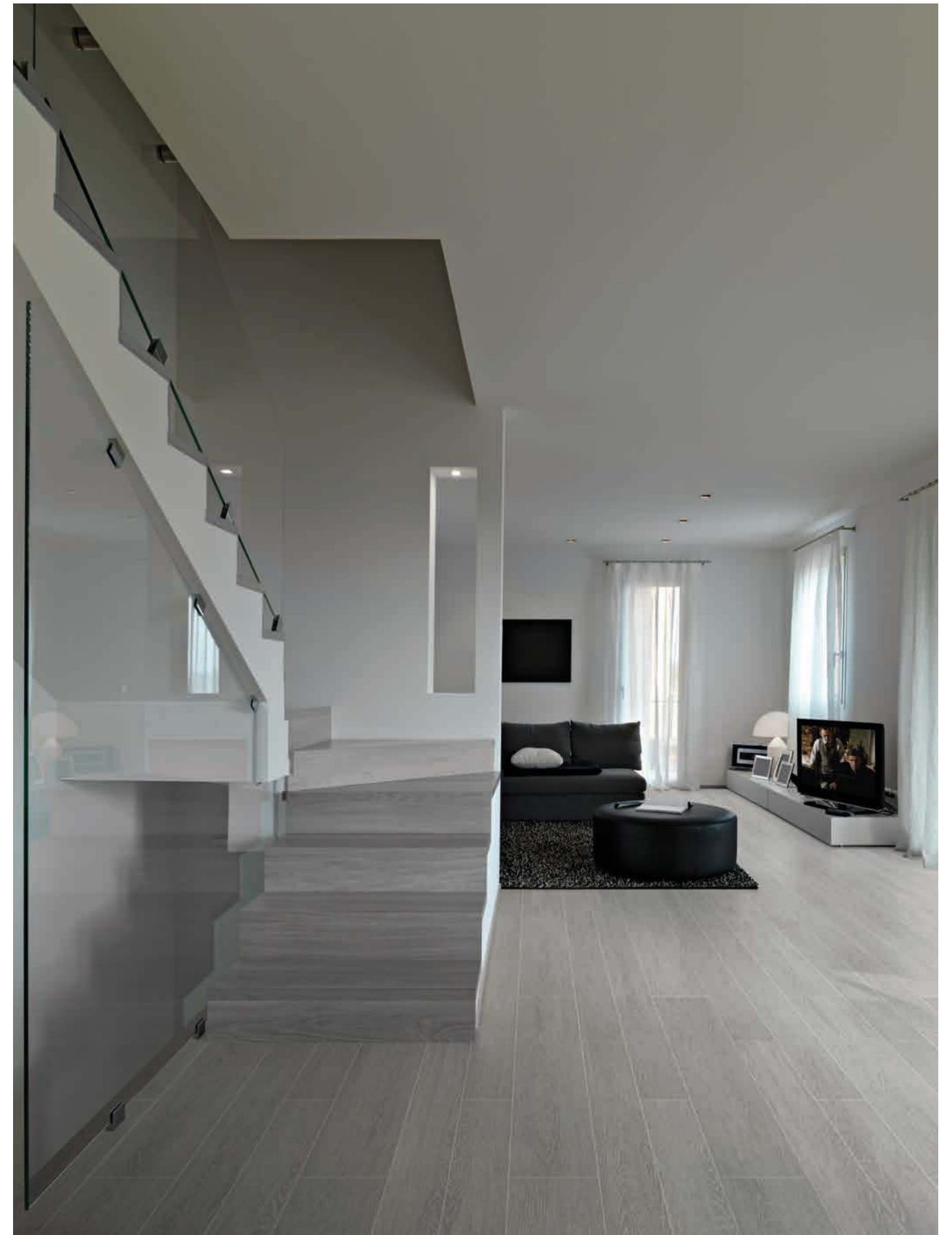

# LEGNO

PORCELÁNICO≈PORCELAIN TILE≈GRÉS CÉRAME≈FEINSTEINZEUG

DESTONIFICACIÓN INTENCIONADA≈INTENTIONALLY NON-HOMOGENEOUS COLOUR≈  
DES VARIATIONS DE NUANCES INTENTIONNÉES≈DESIGNGEMÄÙE ENTFÄRBUNG

## W42 BEIGE

15x90 cm. (6x36") · NATURAL



22,5x90 cm. (9x36") · NATURAL



### ACABADOS / FINISHES

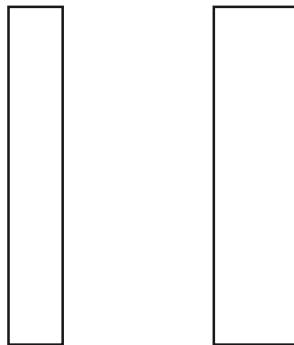

Natural B-71  
15 x 90 cm  
(6" x 36")

Natural B-66  
22,5 x 90 cm  
(9" x 36")

## W41 BIANCO

15x90 cm. (6x36") · NATURAL



22,5x90 cm. (9x36") · NATURAL



### ACABADOS / FINISHES

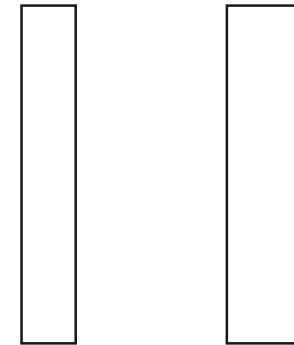

Natural B-71  
15 x 90 cm  
(6" x 36")

Natural B-66  
22,5 x 90 cm  
(9" x 36")

### PACKING LIST

PIEZAS BASE≈BASIC TILES≈ELÉMENTS DE BASE≈GRUNDFLIESEN

CM	SIZE	ACABADO/FINISH	PIEZAS CAJA/ PIECES BOX	KG CAJA	M² CAJA	SQFT BOX	CAJAS/BOXES EUROPALET	M² EUROPALET	SQFT EUROPALLET	KG EUROPALET
15 x 90	6" x 36"	NATURAL	6	20,10	0,81	8,72	48	38,88	418,56	991,80
22,5 x 90	9" x 36"	NATURAL	4	20,40	0,81	8,72	42	34,02	366,19	883,80

### PACKING LIST

PIEZAS BASE≈BASIC TILES≈ELÉMENTS DE BASE≈GRUNDFLIESEN

CM	SIZE	ACABADO/FINISH	PIEZAS CAJA/ PIECES BOX	KG CAJA	M² CAJA	SQFT BOX	CAJAS/BOXES EUROPALET	M² EUROPALET	SQFT EUROPALLET	KG EUROPALET
15 x 90	6" x 36"	NATURAL	6	20,10	0,81	8,72	48	38,88	418,56	991,80
22,5 x 90	9" x 36"	NATURAL	4	20,40	0,81	8,72	42	34,02	366,19	883,80

# LEGNO

PORCELÁNICO≈PORCELAIN TILE≈GRÉS CÉRAMÉ≈FEINSTEINZEUG

DESTONIFICACIÓN INTENCIONADA≈INTENTIONALLY NON-HOMOGENEOUS COLOUR≈  
DES VARIATIONS DE NUANCES INTENTIONNÉES≈DESIGNGEMÄßE ENTFÄRBUNG

## W44 GRIGIO ≡

15x90 cm. (6x36") · NATURAL



22,5x90 cm. (9x36") · NATURAL



### ACABADOS / FINISHES



NATURAL

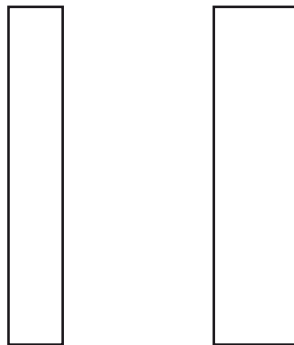

Natural B-71  
15 x 90 cm  
(6" x 36")

Natural B-66  
22,5 x 90 cm  
(9" x 36")

## W43 SCURO ≡

15x90 cm. (6x36") · NATURAL



22,5x90 cm. (9x36") · NATURAL



### ACABADOS / FINISHES



NATURAL

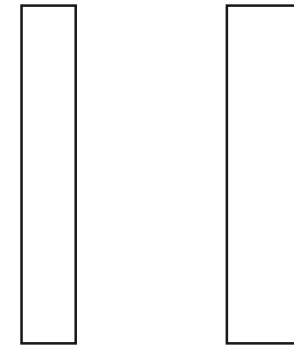

Natural B-71  
15 x 90 cm  
(6" x 36")

Natural B-66  
22,5 x 90 cm  
(9" x 36")

### PACKING LIST

PIEZAS BASE≈BASIC TILES≈ELÉMENTS DE BASE≈GRUNDFLIESEN

CM	SIZE	ACABADO/FINISH	PIEZAS CAJA/ PIECES BOX	KG CAJA	M² CAJA	SQFT BOX	CAJAS/BOXES EUROPALET	M² EUROPALET	SQFT EUROPALLET	KG EUROPALET
15 x 90	6" x 36"	NATURAL	6	20,10	0,81	8,72	48	38,88	418,56	991,80
22,5 x 90	9" x 36"	NATURAL	4	20,40	0,81	8,72	42	34,02	366,19	883,80

### PACKING LIST

PIEZAS BASE≈BASIC TILES≈ELÉMENTS DE BASE≈GRUNDFLIESEN

CM	SIZE	ACABADO/FINISH	PIEZAS CAJA/ PIECES BOX	KG CAJA	M² CAJA	SQFT BOX	CAJAS/BOXES EUROPALET	M² EUROPALET	SQFT EUROPALLET	KG EUROPALET
15 x 90	6" x 36"	NATURAL	6	20,10	0,81	8,72	48	38,88	418,56	991,80
22,5 x 90	9" x 36"	NATURAL	4	20,40	0,81	8,72	42	34,02	366,19	883,80

# LEGNO

PORCELÁNICO≈PORCELAIN TILE≈GRÉS CÉRAME≈FEINSTEINZEUG

DESTONIFICACIÓN INTENCIONADA≈INTENTIONALLY NON-HOMOGENEOUS COLOUR≈  
DES VARIATIONS DE NUANCES INTENTIONNÉES≈DESIGNEMÄßE ENTFÄRBUNG

≈ Legno Grigio 15x90 natural.



## PIEZAS COMPLEMENTARIAS≈ACCESSORIES≈ACCESSOIRES ET DECORATIONS≈FORMTEILE

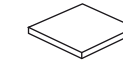

**Taco**  
*Insert*  
8 x 8 cm (3,2" x 3,2")

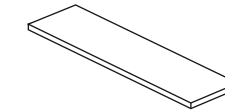

**Listel**  
*Listel*  
8 x 45 cm (3,2" x 18")  
8 x 90 cm (3,2" x 36")

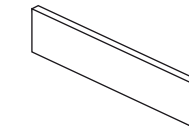

**Rodapié Cortado**  
*Straight skirting*  
8 x 45 cm (3,2" x 18")  
8 x 90 cm (3,2" x 36")

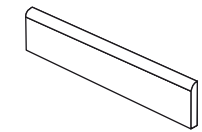

**Rodapié Canto Romo**  
*Skirting bullnose*  
8 x 45 cm (3,2" x 18")  
8 x 90 cm (3,2" x 36")

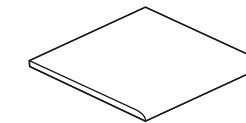

**Canto Romo**  
*Rounded edge piece*  
45 x 90 cm (18" x 36")

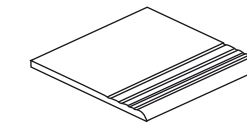

**Peldaño Ranurado**  
*Grooved stair tread*  
45 x 90 cm (18" x 36")

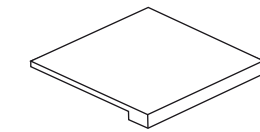

**Peldaño Elit con o sin ranura**  
*Grooved Elit Stair/Plain Elit Stair*  
45 x 90 cm (18" x 36")

### PACKING LIST

PIEZAS ESPECIALES≈SPECIAL ACCESSORIES≈ÉLÉMENTS SPÉCIAUX≈SPEZIALTEILE

PIEZA/PIECE	CM	SIZE	ACABADO/ FINISH	PRECIO/ PRICE	PIEZA/PIECE	CM	SIZE	ACABADO/ FINISH	PRECIO/ PRICE
Taco - Insert	8x8	3,2" x 3,2"	NATURAL	P-02	Canto Romo 1 lado - Rounded edge piece 1 side	45x90	18" x 36"	NATURAL	P-35
Rodapié Cortado - Straight skirting	8x45	3,2" x 18"	NATURAL	P-04	Canto Romo 2 lados - Rounded edge piece 2 sides	45x90	18" x 36"	NATURAL	P-45
Rodapié Cortado - Straight skirting	8x90	3,2" x 36"	NATURAL	P-08	Peldaño Ranurado - Grooved stair tread	45x90	18" x 36"	NATURAL	P-35
Rodapié Canto Romo - Skirting bullnose	8x45	3,2" x 18"	NATURAL	P-05	Peldaño Ranurado Esquina - Grooved stair tread corner	45x90	18" x 36"	NATURAL	P-45
Rodapié Canto Romo - Skirting bullnose	8x90	3,2" x 36"	NATURAL	P-10	Peldaño Elit (lado 45) - Elit step (18" side)	45x90	18" x 36"	NATURAL	P-54
Listel	8x45	3,2" x 18"	NATURAL	P-04	Peldaño Elit (lado 90) - Elit step (36" side)	45x90	18" x 36"	NATURAL	P-81
Listel	8x90	3,2" x 36"	NATURAL	P-08	Peldaño Elit Esquina - Elit step corner	45x90	18" x 36"	NATURAL	P-114

Estas piezas se venden por unidad, a excepción de los rodapiés que se venden en cajas de 10 uds.  
These items are sold by pieces with the exception of the skirtings which are sold by boxes of 10 pieces each.  
Unité de vente à la pièce, sauf les plinthes vendus à la boîte de 10 unités.  
Die Formteile sind pro Stück verkauft außer die Sockel, die pro Karton mit 10 Stück verkauft sind.

∨ Lifestone Arena 60x60 mate.









# LIFESTONE





PORCELÁNICO≈PORCELAIN TILE≈GRÉS CÉRAMÉ≈FEINSTEINZEUG

ACABADOS FINISHES

**CARACTERÍSTICAS TÉCNICAS**  
TECHNICAL CHARACTERISTICS

**FORMATOS≈SIZES**  
30 x 60 cm (12" x 24")  
45 x 90 cm (18" x 36")  
60 x 60 cm (24" x 24")

Consulte página 10≈See page 10≈  
Voir page 10≈Sehen Sie Seite 10

**ÁMBITOS DE USO≈AREA OF USE**

**MATE**  
Idóneo para zonas interiores secas.  
*Suitable for dry indoor areas.*  
*Idéal pour application intérieure sèche.*  
*Ideal für trockene Innenräume.*

**ANTI - SLIP**  
45°



**ANTIDESLIZANTE**  
Recomendado para interiores húmedos, exteriores y piscinas.  
*Suitable for wet indoor areas, outdoor areas and swimming pools.*  
*Idéal pour application intérieure humide et pour extérieurs et piscines.*  
*Ideal für Nassbereiche, innen sowie außen und in Schwimmbädern.*

**NORMA≈NORM**

NORMA UNE-ENV 12633:2003  
- Lifestone Mate: Clase 1  
- Lifestone Antideslizante: Clase 3

NORMA DIN 51130  
- Lifestone Mate: R - 9  
- Lifestone Antideslizante: R - 10

NORMA DIN 51097 (Pie descalzo)  
- Lifestone Antideslizante: Grupo C

FORMATO	MATE
30 x 60	U4 P3 E3 C2
60 x 60	U4 P4+ E3 C2

**MODELOS MODELS**

GRAFITO

GRIS

NÁCAR

ARENA

≡ MATE ≡
≡ ANTIDESLIZANTE ≡



Detalle a escala 1:1 ≈ Detail scale 1:1 ≈ Detail échelle 1:1 ≈ Maßstab 1:1

	MATE	ANTIDESLIZANTE
GRAFITO	●	●
GRIS	●	●
NÁCAR	●	●
ARENA	●	●

# LIFESTONE

PORCELÁNICO~PORCELAIN TILE~GRÉS CÉRAME~FEINSTEINZEUG

∞ Lifestone Grafito 30x60 mate.



# LIFESTONE

PORCELÁNICO~PORCELAIN TILE~GRÉS CÉRAME~FEINSTEINZEUG

≡ Lifestone Grafito 30x60 mate.



≡ Lifestone Nacar 45x90 mate.

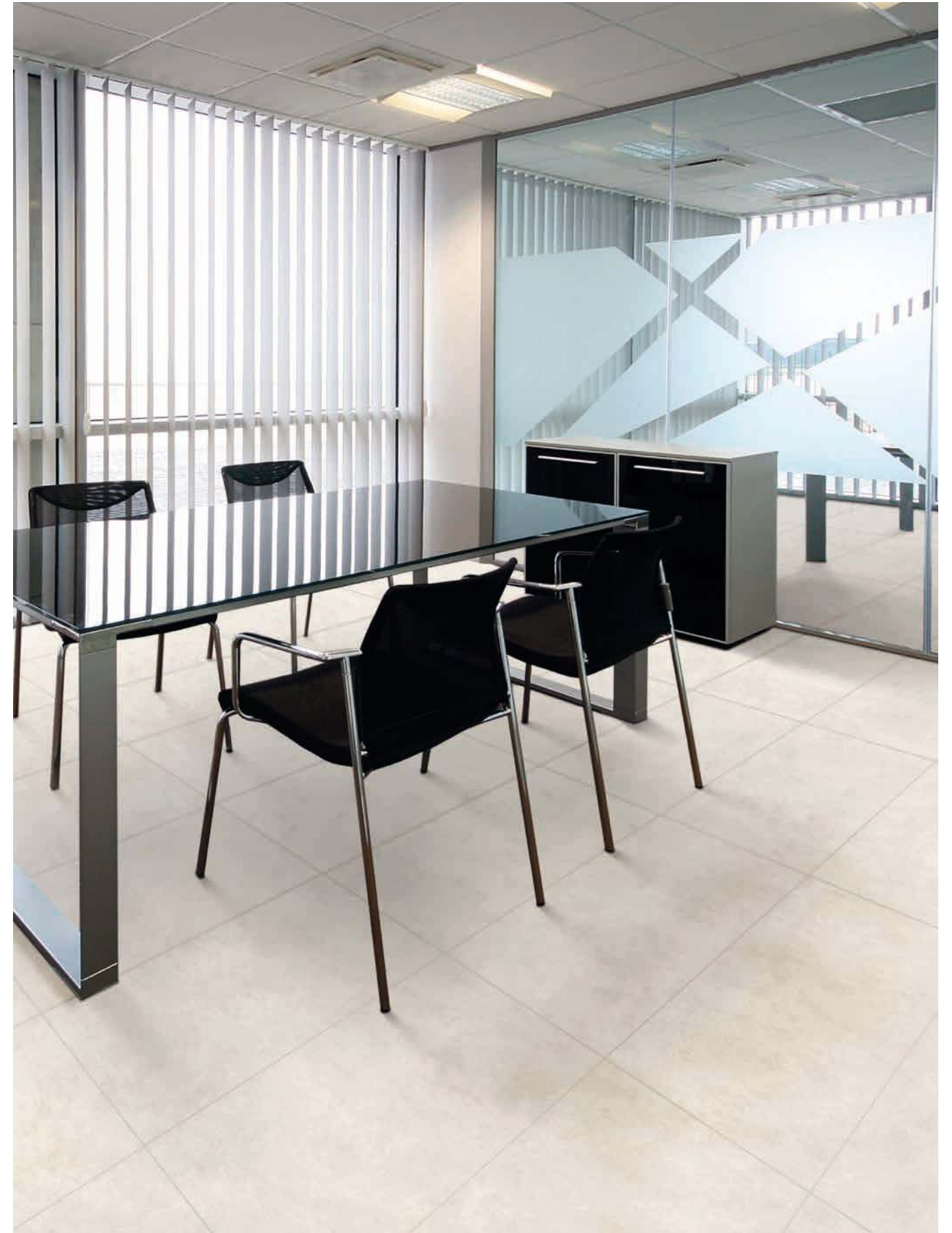

# LIFESTONE

PORCELÁNICO~PORCELAIN TILE~GRÉS CÉRAME~FEINSTEINZEUG

≈ Mosaico 3D Lifestone Nacar.



≈ Lifestone Grafito 60x60 mate + Lifestone Grafito 30x60 mate + Mosaico 2,3x9,8 Lifestone frío.



# LIFESTONE

PORCELÁNICO≈PORCELAIN TILE≈GRÉS CÉRAME≈FEINSTEINZEUG

DESTONIFICACIÓN INTENCIONADA≈INTENTIONALLY NON-HOMOGENEOUS COLOUR≈  
DES VARIATIONS DE NUANCES INTENTIONNÉES≈DESIGNGEMÄÙE ENTFÄRBUNG

## L14 GRAFITO

Reciclado

30x60 cm. (12x24") · MATE



### ACABADOS / FINISHES

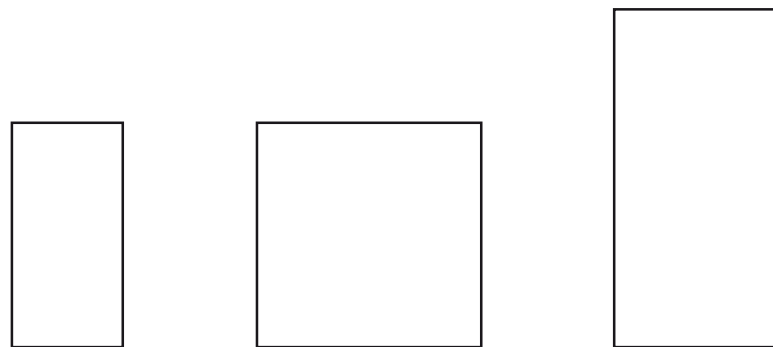
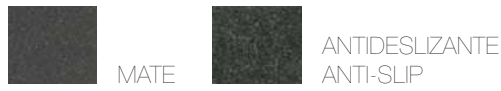

Mate B-54 Antideslizante B-59 30 x 60 cm (12" x 24")	Mate B-64 60 x 60 cm (24" x 24")	Mate B-68 45 x 90 cm (18" x 36")
---	--	--

### PACKING LIST

PIEZAS BASE≈BASIC TILES≈ELÉMENTS DE BASE≈GRUNDFLIESEN

CM	SIZE	ACABADO/FINISH	PIEZAS CAJA/ PIECES BOX	KG CAJA	M² CAJA	SQFT BOX	CAJAS/BOXES EUROPALET	M² EUROPALET	SQFT EUROPALLET	KG EUROPALET
30 x 60	12" x 24"	TODOS	6	24,00	1,08	11,62	48	51,84	558,00	1179,00
60 x 60	24" x 24"	MATE	4	33,20	1,44	15,50	32	46,08	496,00	1089,40
45 x 90	18" x 36"	MATE	2	20,50	0,81	8,72	39	31,59	340,03	826,50

## L11 GRIS

Reciclado

30x60 cm. (12x24") · MATE



### ACABADOS / FINISHES

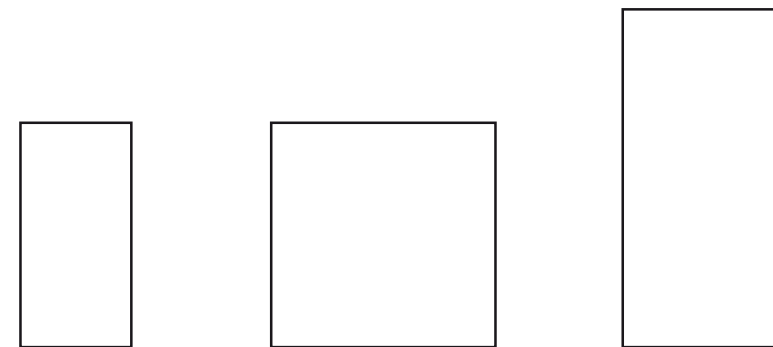

Mate B-51 Antideslizante B-56 30 x 60 cm (12" x 24")	Mate B-60 60 x 60 cm (24" x 24")	Mate B-64 45 x 90 cm (18" x 36")
---	--	--

### PACKING LIST

PIEZAS BASE≈BASIC TILES≈ELÉMENTS DE BASE≈GRUNDFLIESEN

CM	SIZE	ACABADO/FINISH	PIEZAS CAJA/ PIECES BOX	KG CAJA	M² CAJA	SQFT BOX	CAJAS/BOXES EUROPALET	M² EUROPALET	SQFT EUROPALLET	KG EUROPALET
30 x 60	12" x 24"	TODOS	6	24,00	1,08	11,62	48	51,84	558,00	1179,00
60 x 60	24" x 24"	MATE	4	33,20	1,44	15,50	32	46,08	496,00	1089,40
45 x 90	18" x 36"	MATE	2	20,50	0,81	8,72	39	31,59	340,03	826,50

# LIFESTONE

PORCELÁNICO≈PORCELAIN TILE≈GRÉS CÉRAME≈FEINSTEINZEUG

DESTONIFICACIÓN INTENCIONADA≈INTENTIONALLY NON-HOMOGENEOUS COLOUR≈  
DES VARIATIONS DE NUANCES INTENTIONNÉES≈DESIGNGEMÄÙE ENTFÄRBUNG

## L15 NACAR ≈

30x60 cm. (12x24") · MATE



ACABADOS / FINISHES

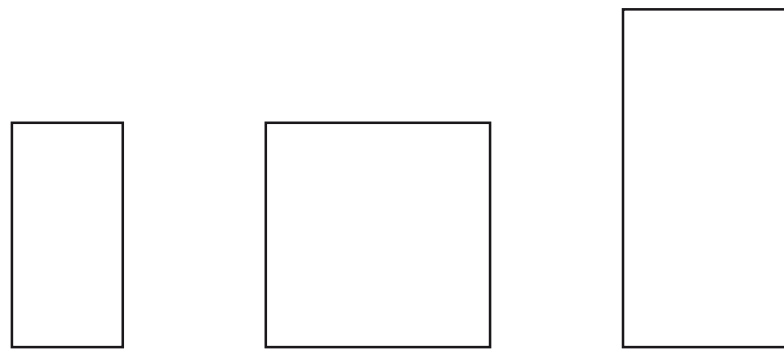

Mate B-54 Antideslizante B-59 30 x 60 cm (12" x 24")	Mate B-64 60 x 60 cm (24" x 24")	Mate B-68 45 x 90 cm (18" x 36")
---	--	--

### PACKING LIST

PIEZAS BASE≈BASIC TILES≈ELÉMENTS DE BASE≈GRUNDFLIESEN

CM	SIZE	ACABADO/FINISH	PIEZAS CAJA/ PIECES BOX	KG CAJA	M² CAJA	SQFT BOX	CAJAS/BOXES EUROPALET	M² EUROPALET	SQFT EUROPALLET	KG EUROPALET
30 x 60	12" x 24"	TODOS	6	24,00	1,08	11,62	48	51,84	558,00	1179,00
60 x 60	24" x 24"	MATE	4	33,20	1,44	15,50	32	46,08	496,00	1089,40
45 x 90	18" x 36"	MATE	2	20,50	0,81	8,72	39	31,59	340,03	826,50

## L12 ARENA ≈

30x60 cm. (12x24") · MATE



ACABADOS / FINISHES

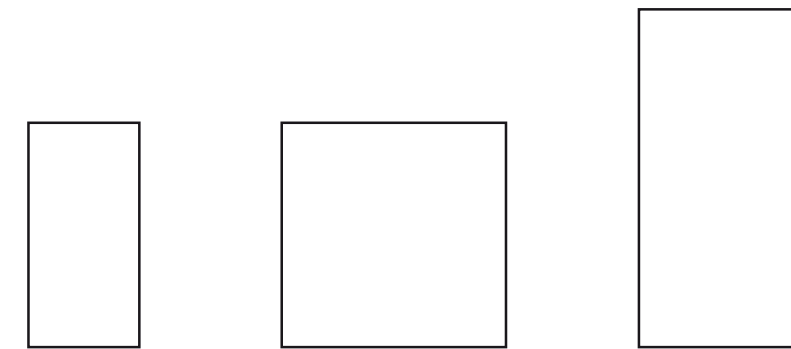

Mate B-51 Antideslizante B-56 30 x 60 cm (12" x 24")	Mate B-60 60 x 60 cm (24" x 24")	Mate B-64 45 x 90 cm (18" x 36")
---	--	--

### PACKING LIST

PIEZAS BASE≈BASIC TILES≈ELÉMENTS DE BASE≈GRUNDFLIESEN

CM	SIZE	ACABADO/FINISH	PIEZAS CAJA/ PIECES BOX	KG CAJA	M² CAJA	SQFT BOX	CAJAS/BOXES EUROPALET	M² EUROPALET	SQFT EUROPALLET	KG EUROPALET
30 x 60	12" x 24"	TODOS	6	24,00	1,08	11,62	48	51,84	558,00	1179,00
60 x 60	24" x 24"	MATE	4	33,20	1,44	15,50	32	46,08	496,00	1089,40
45 x 90	18" x 36"	MATE	2	20,50	0,81	8,72	39	31,59	340,03	826,50

# LIFESTONE

PORCELÁNICO≈PORCELAIN TILE≈GRÉS CÉRAME≈FEINSTEINZEUG

DESTONIFICACIÓN INTENCIONADA≈INTENTIONALLY NON-HOMOGENEOUS COLOUR≈  
DES VARIATIONS DE NUANCES INTENTIONNÉES≈DESIGNEMÄßE ENTFÄRBUNG

## PIEZAS COMPLEMENTARIAS≈ACCESSORIES≈ACCESSOIRES ET DECORATIONS≈FORMTEILE



MOSAICO 2,3x9,8  
LIFESTONE FRÍO  
30 x 30 cm (12" x 12")  
P-16

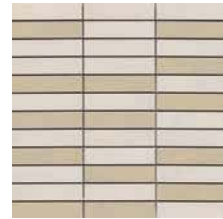

MOSAICO 2,3x9,8  
LIFESTONE CÁLIDO  
30 x 30 cm (12" x 12")  
P-16



MOSAICO L1  
30 x 30 cm (12" x 12")  
P-10



MOSAICO 3D  
LIFESTONE GRAFITO  
30 x 30 cm (12" x 12")  
P-19



MOSAICO 3D  
LIFESTONE GRIS  
30 x 30 cm (12" x 12")  
P-19



MOSAICO 3D  
LIFESTONE NACAR  
30 x 30 cm (12" x 12")  
P-19



MOSAICO 3D  
LIFESTONE ARENA  
30 x 30 cm (12" x 12")  
P-19

### PACKING LIST

COMPLEMENTOS DECORATIVOS≈DECORATIVE ACCESSORIES≈COMPLÉMENTS DE DÉCORATION≈FORMTEILE

PIEZA/PIECE	CM	SIZE	PRECIO/ PRICE	PIEZA/PIECE	CM	SIZE	PRECIO/ PRICE
Mosaico 2,3x9,8 Lifestone Frío	30x30	12" x 12"	P-16	Mosaico 3D Lifestone Grafito	30x30	12" x 12"	P-19
Mosaico 2,3x9,8 Lifestone Cálido	30x30	12" x 12"	P-16	Mosaico 3D Lifestone Gris	30x30	12" x 12"	P-19
Mosaico L1	30x30	12" x 12"	P-10	Mosaico 3D Lifestone Nacar	30x30	12" x 12"	P-19
				Mosaico 3D Lifestone Arena	30x30	12" x 12"	P-19

☞ Mosaico L1 + Incisión Lifestone Arena 30x60.



## PIEZAS COMPLEMENTARIAS≈ACCESSORIES≈ACCESSOIRES ET DECORATIONS≈FORMTEILE

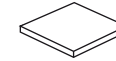

**Taco**  
*Insert*  
8 x 8 cm (3,2" x 3,2")

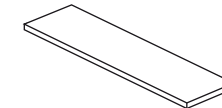

**Listel**  
*Listel*  
8 x 30 cm (3,2" x 12")  
8 x 45 cm (3,2" x 18")  
8 x 60 cm (3,2" x 24")  
8 x 90 cm (3,2" x 36")

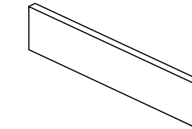

**Rodapié Cortado**  
*Straight skirting*  
8 x 30 cm (3,2" x 12")  
8 x 45 cm (3,2" x 18")  
8 x 60 cm (3,2" x 24")  
8 x 90 cm (3,2" x 36")

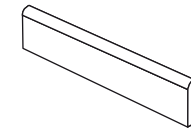

**Rodapié Canto Romo**  
*Skirting bullnose*  
8 x 30 cm (3,2" x 12")  
8 x 45 cm (3,2" x 18")  
8 x 60 cm (3,2" x 24")  
8 x 90 cm (3,2" x 36")

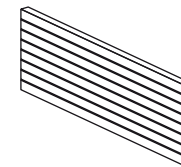

**Incisión**  
*Incision*  
30 x 60 cm (12" x 24")

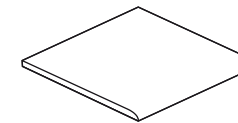

**Canto Romo**  
*Rounded edge piece*  
30 x 60 cm (12" x 24")  
45 x 90 cm (18" x 36")  
60 x 60 cm (24" x 24")

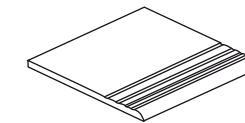

**Peldaño Ranurado**  
*Grooved stair tread*  
30 x 60 cm (12" x 24")  
45 x 90 cm (18" x 36")  
60 x 60 cm (24" x 24")

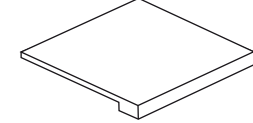

**Peldaño Elit con o sin ranura**  
*Grooved Elit Stair/Plain Elit Stair*  
30 x 60 cm (12" x 24")  
45 x 90 cm (18" x 36")  
60 x 60 cm (24" x 24")

### PACKING LIST

PIEZAS ESPECIALES≈SPECIAL ACCESSORIES≈ÉLÉMENTS SPÉCIAUX≈SPEZIALTEILE

PIEZA/PIECE	CM	SIZE	ACABADO/ FINISH	PRECIO/ PRICE	PIEZA/PIECE	CM	SIZE	ACABADO/ FINISH	PRECIO/ PRICE
Taco - Insert	8x8	3,2" x 3,2"	TODOS	P-02	Canto Romo 2 lados - Rounded edge piece 2 sides	30x60	12" x 24"	TODOS	P-25
Rodapié Cortado - Straight skirting	8x30	3,2" x 12"	TODOS	P-02	Canto Romo 2 lados - Rounded edge piece 2 sides	45x90	18" x 36"	MATE	P-49
Rodapié Cortado - Straight skirting	8x45	3,2" x 18"	TODOS	P-04	Canto Romo 2 lados - Rounded edge piece 2 sides	60x60	24" x 24"	MATE	P-38
Rodapié Cortado - Straight skirting	8x60	3,2" x 24"	TODOS	P-05	Peldaño Ranurado - Grooved stair tread	30x60	12" x 24"	TODOS	P-18
Rodapié Cortado - Straight skirting	8x90	3,2" x 36"	TODOS	P-08	Peldaño Ranurado - Grooved stair tread	45x90	18" x 36"	MATE	P-38
Rodapié Canto Romo - Skirting bullnose	8x30	3,2" x 12"	TODOS	P-03	Peldaño Ranurado - Grooved stair tread	60x60	24" x 24"	MATE	P-31
Rodapié Canto Romo - Skirting bullnose	8x45	3,2" x 18"	TODOS	P-05	Peldaño Ranurado Esquina - Grooved stair tread corner	30x60	12" x 24"	TODOS	P-25
Rodapié Canto Romo - Skirting bullnose	8x60	3,2" x 24"	TODOS	P-06	Peldaño Ranurado Esquina - Grooved stair tread corner	45x90	18" x 36"	MATE	P-49
Rodapié Canto Romo - Skirting bullnose	8x90	3,2" x 36"	TODOS	P-10	Peldaño Ranurado Esquina - Grooved stair tread corner	60x60	24" x 24"	MATE	P-38
Listel	8x30	3,2" x 12"	TODOS	P-02	Peldaño Elit (lado 30) - Elit step (12" side)	30x60	12" x 24"	TODOS	P-30
Listel	8x45	3,2" x 18"	TODOS	P-04	Peldaño Elit (lado 60) - Elit step (24" side)	30x60	12" x 24"	TODOS	P-48
Listel	8x60	3,2" x 24"	TODOS	P-05	Peldaño Elit (lado 45) - Elit step (18" side)	45x90	18" x 36"	MATE	P-57
Listel	8x90	3,2" x 36"	TODOS	P-08	Peldaño Elit (lado 90) - Elit step (36" side)	45x90	18" x 36"	MATE	P-84
Incisión	30x60	12" x 24"	TODOS	P-14	Peldaño Elit - Elit step	60x60	24" x 24"	MATE	P-62
Canto Romo 1 lado - Rounded edge piece 1 side	30x60	12" x 24"	TODOS	P-18	Peldaño Elit Esquina - Elit step corner	30x60	12" x 24"	TODOS	P-69
Canto Romo 1 lado - Rounded edge piece 1 side	45x90	18" x 36"	MATE	P-38	Peldaño Elit Esquina - Elit step corner	45x90	18" x 36"	MATE	P-118
Canto Romo 1 lado - Rounded edge piece 1 side	60x60	24" x 24"	MATE	P-31	Peldaño Elit Esquina - Elit step corner	60x60	24" x 24"	MATE	P-104

Estas piezas se venden por unidad, a excepción de los rodapiés que se venden en cajas de 10 uds.  
These items are sold by pieces with the exception of the skirtings which are sold by boxes of 10 pieces each.  
Unité de vente à la pièce, sauf les plinthes vendus à la boîte de 10 unités.  
Die Formteile sind pro Stück verkauft außer die Sockel, die pro Karton mit 10 Stück verkauft sind.

≈ Maderas Arce 15x90 natural + Maderas Roble Oscuro 15x90 natural.









# MADERAS





PORCELÁNICO≈PORCELAIN TILE≈GRÉS CÉRAME≈FEINSTEINZEUG

ACABADOS FINISHES

**CARACTERÍSTICAS TÉCNICAS**  
TECHNICAL CHARACTERISTICS

**FORMATOS≈SIZES**  
15 x 90 cm (6" x 36")  
22,5 x 90 cm (9" x 36")

Consulte página 10≈See page 10≈  
Voir page 10≈Sehen Sie Seite 10

**ÁMBITOS DE USO≈AREA OF USE**

**NATURAL**  
Recomendado para interiores secos, húmedos, exteriores y piscinas.  
*Suitable for dry and wet indoor areas, outdoor areas and swimming pools.*  
*Idéal pour application intérieure sèche ainsi que humide et pour extérieurs et piscines.*  
*Ideal für trockene Innenräume, Nassbereiche, innen sowie außen und in Schwimmbädern.*

**LUCIDATO**  
Idóneo para zonas interiores secas.  
*Suitable for dry indoor areas.*  
*Idéal pour application intérieure sèche.*  
*Ideal für trockene Innenräume.*

**NORMA≈NORM**

NORMA UNE-ENV 12633:2003  
- Maderas Natural: Clase 3  
- Maderas Lucidato: Clase 1

**MODELOS MODELS**

ARCE

HAYA

ROBLE CLARO

ROBLE OSCURO



≈ NATURAL ≈

≈ LUCIDATO ≈



Detalle a escala 1:1 ≈ Detail scale 1:1 ≈ Detail échelle 1:1 ≈ Maßstab 1:1

	NATURAL	LUCIDATO
ARCE	●	●
HAYA	●	●
ROBLE CLARO	●	●
ROBLE OSCURO	●	●

# MADERAS

PORCELÁNICO~PORCELAIN TILE~GRÉS CÉRAME~FEINSTEINZEUG

≡ Maderas Roble Claro 15x90 natural.



≡ Maderas Roble Oscuro 15x90 natural.

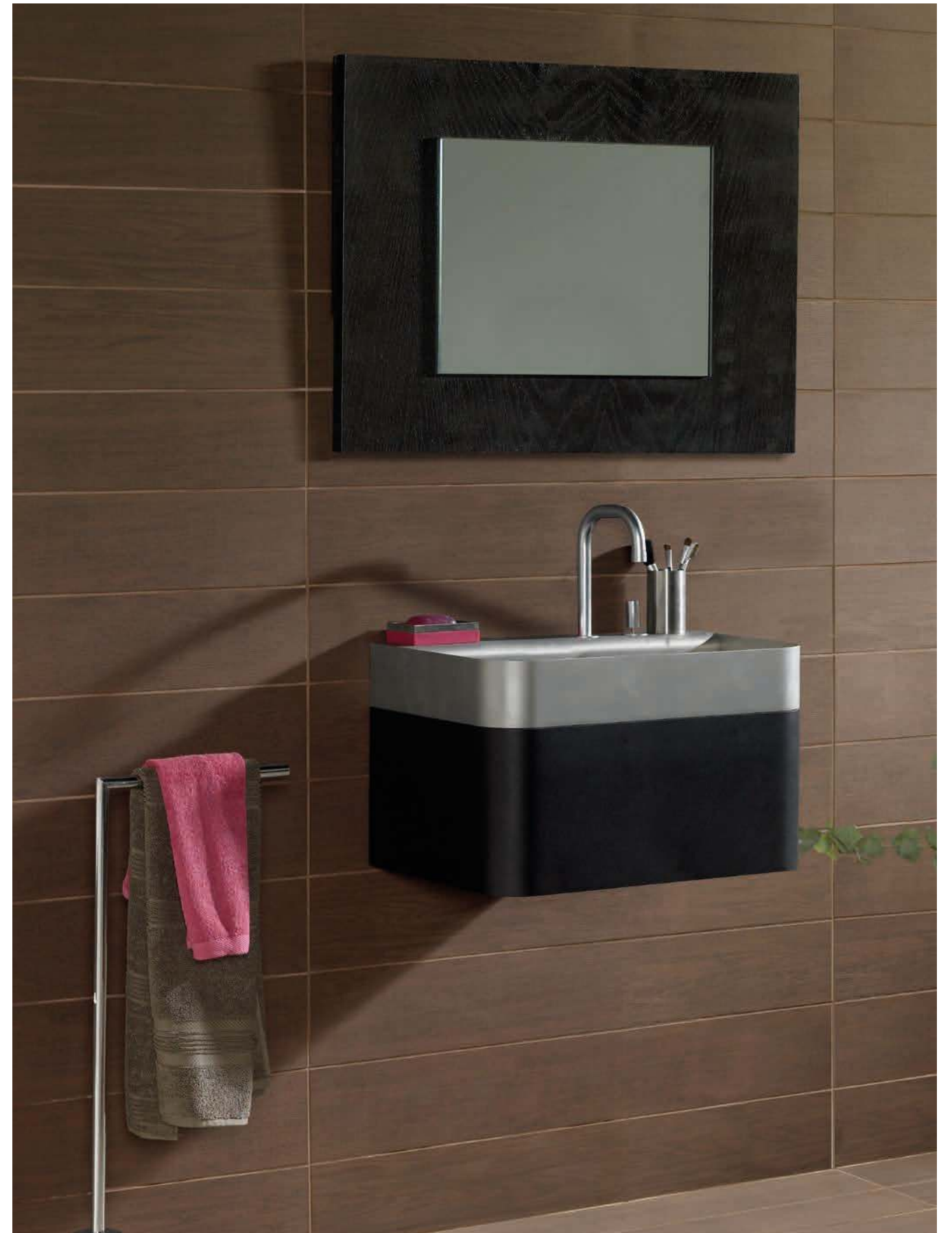

# MADERAS

PORCELÁNICO~PORCELAIN TILE~GRÉS CÉRAME~FEINSTEINZEUG

≈ Maderas Roble Oscuro 15x90 natural + Maderas Roble Claro 15x90 natural.



≈ Maderas Haya 15x90 natural + Maderas Roble Oscuro 15x90 natural.

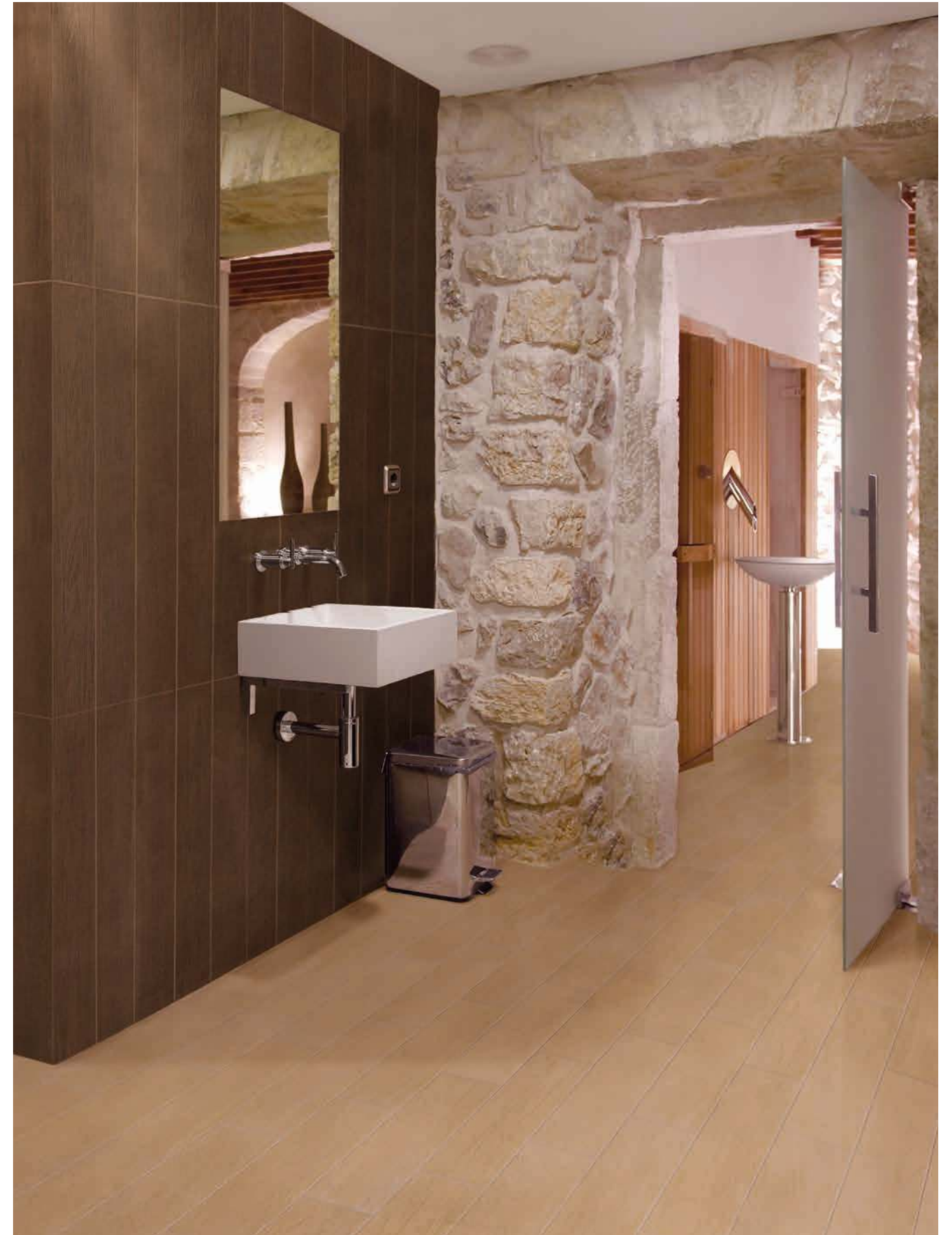

# MADERAS

PORCELÁNICO≈PORCELAIN TILE≈GRÉS CÉRAME≈FEINSTEINZEUG

DESTONIFICACIÓN INTENCIONADA≈INTENTIONALLY NON-HOMOGENEOUS COLOUR≈  
DES VARIATIONS DE NUANCES INTENTIONNÉES≈DESIGNGEMÄÙE ENTFÄRBUNG

## E41 ARCE ≡

15x90 cm. (6x36") · NATURAL



22,5x90 cm. (9x36") · NATURAL



### ACABADOS / FINISHES

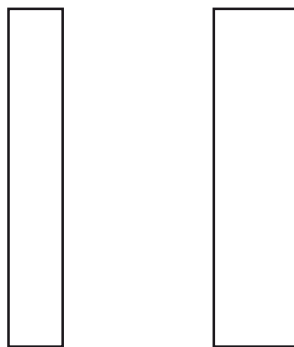

Natural B-66	Natural B-61
Lucidato B-74	Lucidato B-69
15 x 90 cm	22,5 x 90 cm
(6" x 36")	(9" x 36")

## E42 HAYA ≡

15x90 cm. (6x36") · NATURAL



22,5x90 cm. (9x36") · NATURAL



### ACABADOS / FINISHES

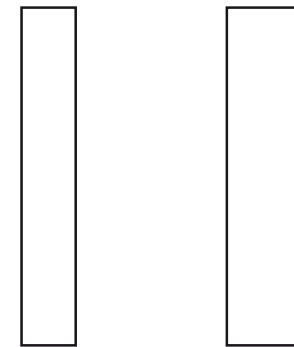

Natural B-66	Natural B-61
Lucidato B-74	Lucidato B-69
15 x 90 cm	22,5 x 90 cm
(6" x 36")	(9" x 36")

### PACKING LIST

PIEZAS BASE≈BASIC TILES≈ELÉMENTS DE BASE≈GRUNDFLIESEN

CM	SIZE	ACABADO/FINISH	PIEZAS CAJA/ PIECES BOX	KG CAJA	M² CAJA	SQFT BOX	CAJAS/BOXES EUROPALET	M² EUROPALET	SQFT EUROPALLET	KG EUROPALET
15 x 90	6" x 36"	TODOS	6	20,10	0,81	8,72	48	38,88	418,56	991,80
22,5 x 90	9" x 36"	TODOS	4	20,40	0,81	8,72	42	34,02	366,19	883,80

### PACKING LIST

PIEZAS BASE≈BASIC TILES≈ELÉMENTS DE BASE≈GRUNDFLIESEN

CM	SIZE	ACABADO/FINISH	PIEZAS CAJA/ PIECES BOX	KG CAJA	M² CAJA	SQFT BOX	CAJAS/BOXES EUROPALET	M² EUROPALET	SQFT EUROPALLET	KG EUROPALET
15 x 90	6" x 36"	TODOS	6	20,10	0,81	8,72	48	38,88	418,56	991,80
22,5 x 90	9" x 36"	TODOS	4	20,40	0,81	8,72	42	34,02	366,19	883,80

# MADERAS

PORCELÁNICO≈PORCELAIN TILE≈GRÉS CÉRAME≈FEINSTEINZEUG

DESTONIFICACIÓN INTENCIONADA≈INTENTIONALLY NON-HOMOGENEOUS COLOUR≈  
DES VARIATIONS DE NUANCES INTENTIONNÉES≈DESIGNGEMÄÙE ENTFÄRBUNG

## E43 ROBLE CLARO ≡

15x90 cm. (6x36") · NATURAL



22,5x90 cm. (9x36") · NATURAL



### ACABADOS / FINISHES

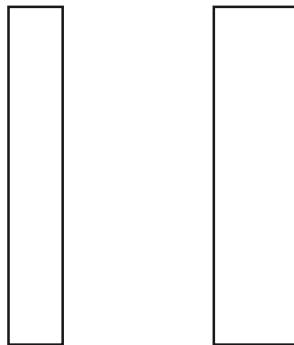

Natural B-66	Natural B-61
Lucidato B-74	Lucidato B-69
15 x 90 cm	22,5 x 90 cm
(6" x 36")	(9" x 36")

## E44 ROBLE OSCURO ≡

Reciclado

15x90 cm. (6x36") · NATURAL



22,5x90 cm. (9x36") · NATURAL



### ACABADOS / FINISHES

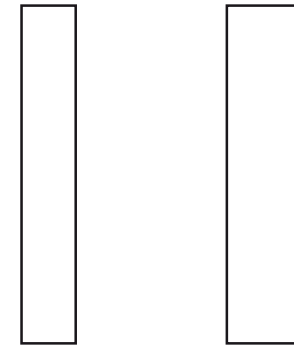

Natural B-66	Natural B-61
Lucidato B-74	Lucidato B-69
15 x 90 cm	22,5 x 90 cm
(6" x 36")	(9" x 36")

### PACKING LIST

PIEZAS BASE≈BASIC TILES≈ELÉMENTS DE BASE≈GRUNDFLIESEN

CM	SIZE	ACABADO/FINISH	PIEZAS CAJA/ PIECES BOX	KG CAJA	M² CAJA	SQFT BOX	CAJAS/BOXES EUROPALET	M² EUROPALET	SQFT EUROPALLET	KG EUROPALET
15 x 90	6" x 36"	TODOS	6	20,10	0,81	8,72	48	38,88	418,56	991,80
22,5 x 90	9" x 36"	TODOS	4	20,40	0,81	8,72	42	34,02	366,19	883,80

### PACKING LIST

PIEZAS BASE≈BASIC TILES≈ELÉMENTS DE BASE≈GRUNDFLIESEN

CM	SIZE	ACABADO/FINISH	PIEZAS CAJA/ PIECES BOX	KG CAJA	M² CAJA	SQFT BOX	CAJAS/BOXES EUROPALET	M² EUROPALET	SQFT EUROPALLET	KG EUROPALET
15 x 90	6" x 36"	TODOS	6	20,10	0,81	8,72	48	38,88	418,56	991,80
22,5 x 90	9" x 36"	TODOS	4	20,40	0,81	8,72	42	34,02	366,19	883,80

# MADERAS

PORCELÁNICO≈PORCELAIN TILE≈GRÉS CÉRAME≈FEINSTEINZEUG

≈ Maderas Haya 15x90 natural.



## PIEZAS COMPLEMENTARIAS≈ACCESSORIES≈ACCESSOIRES ET DECORATIONS≈FORMTEILE

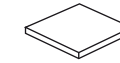

**Taco**  
*Insert*  
8 x 8 cm (3,2" x 3,2")

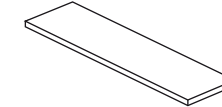

**Listel**  
*Listel*  
8 x 45 cm (3,2" x 18")  
8 x 90 cm (3,2" x 36")

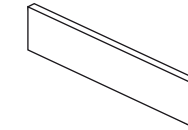

**Rodapié Cortado**  
*Straight skirting*  
8 x 45 cm (3,2" x 18")  
8 x 90 cm (3,2" x 36")

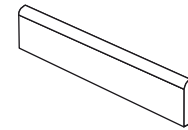

**Rodapié Canto Romo**  
*Skirting bullnose*  
8 x 45 cm (3,2" x 18")  
8 x 90 cm (3,2" x 36")

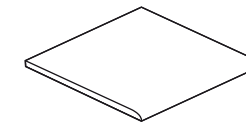

**Canto Romo**  
*Rounded edge piece*  
45 x 90 cm (18" x 36")

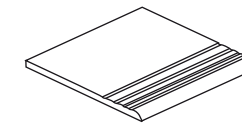

**Peldaño Ranurado**  
*Grooved stair tread*  
45 x 90 cm (18" x 36")

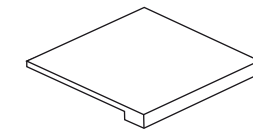

**Peldaño Elit con o sin ranura**  
*Grooved Elit Stair/Plain Elit Stair*  
45 x 90 cm (18" x 36")

### PACKING LIST

PIEZAS ESPECIALES≈SPECIAL ACCESSORIES≈ÉLÉMENTS SPÉCIAUX≈SPEZIALTEILE

PIEZA/PIECE	CM	SIZE	ACABADO/ FINISH	PRECIO/ PRICE	PIEZA/PIECE	CM	SIZE	ACABADO/ FINISH	PRECIO/ PRICE
Taco - Insert	8x8	3,2" x 3,2"	TODOS	P-02	Canto Romo 1 lado - Rounded edge piece 1 side	45x90	18" x 36"	TODOS	P-35
Rodapié Cortado - Straight skirting	8x45	3,2" x 18"	TODOS	P-04	Canto Romo 2 lados - Rounded edge piece 2 sides	45x90	18" x 36"	TODOS	P-45
Rodapié Cortado - Straight skirting	8x90	3,2" x 36"	TODOS	P-08	Peldaño Ranurado - Grooved stair tread	45x90	18" x 36"	TODOS	P-35
Rodapié Canto Romo - Skirting bullnose	8x45	3,2" x 18"	TODOS	P-05	Peldaño Ranurado Esquina - Grooved stair tread corner	45x90	18" x 36"	TODOS	P-45
Rodapié Canto Romo - Skirting bullnose	8x90	3,2" x 36"	TODOS	P-10	Peldaño Elit (lado 45) - Elit step (18" side)	45x90	18" x 36"	TODOS	P-54
Listel	8x45	3,2" x 18"	TODOS	P-04	Peldaño Elit (lado 90) - Elit step (36" side)	45x90	18" x 36"	TODOS	P-81
Listel	8x90	3,2" x 36"	TODOS	P-08	Peldaño Elit Esquina - Elit step corner	45x90	18" x 36"	TODOS	P-114

Estas piezas se venden por unidad, a excepción de los rodapiés que se venden en cajas de 10 uds.  
These items are sold by pieces with the exception of the skirtings which are sold by boxes of 10 pieces each.  
Unité de vente à la pièce, sauf les plinthes vendus à la boîte de 10 unités.  
Die Formteile sind pro Stück verkauft außer die Sockel, die pro Karton mit 10 Stück verkauft sind.

≈ Onix Negro 30x60 rústico + Muro Onix Negro.



## CARACTERÍSTICAS TÉCNICAS TECHNICAL CHARACTERISTICS

### FORMATOS~SIZES

30 x 60 cm (12" x 24")  
45 x 90 cm (18" x 36")

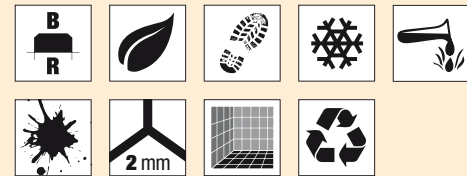

Consulte página 10~See page 10~  
Voir page 10~Sehen Sie Seite 10

### ÁMBITOS DE USO~AREA OF USE



#### RÚSTICO

Idóneo para interiores húmedos,  
escaleras, entradas y exteriores  
cubiertos.

*Suitable for wet indoor areas, steps and  
entrance areas.*

*Idéal pour intérieurs humides / escalier  
et entrées.*

*Ideal für feuchte Innerräume,  
Treppenhäuser und Eingänge.*

### NORMA~NORM

NORMA UNE-ENV 12633:2003  
- Onix Rústico: Clase 2

NORMA DIN 51130  
- Onix Rústico: R - 10

NORMA DIN 51097 (Pie descalzo)  
- Onix Rústico: Grupo C

## MODELOS MODELS

≈  
BLANCO

≈  
NEGRO

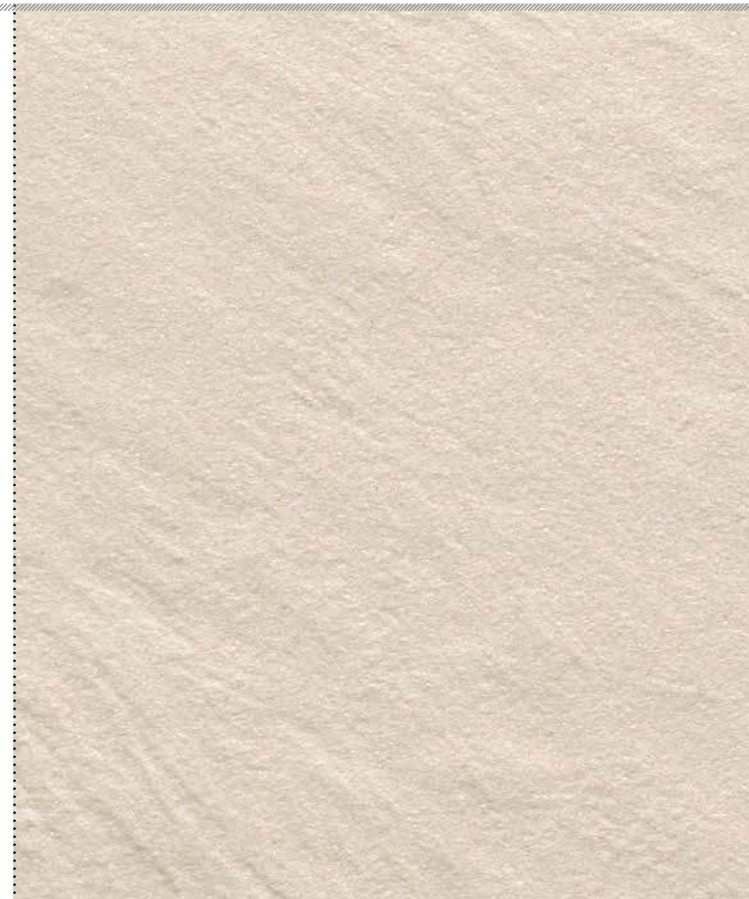

≈ RÚSTICO ≈

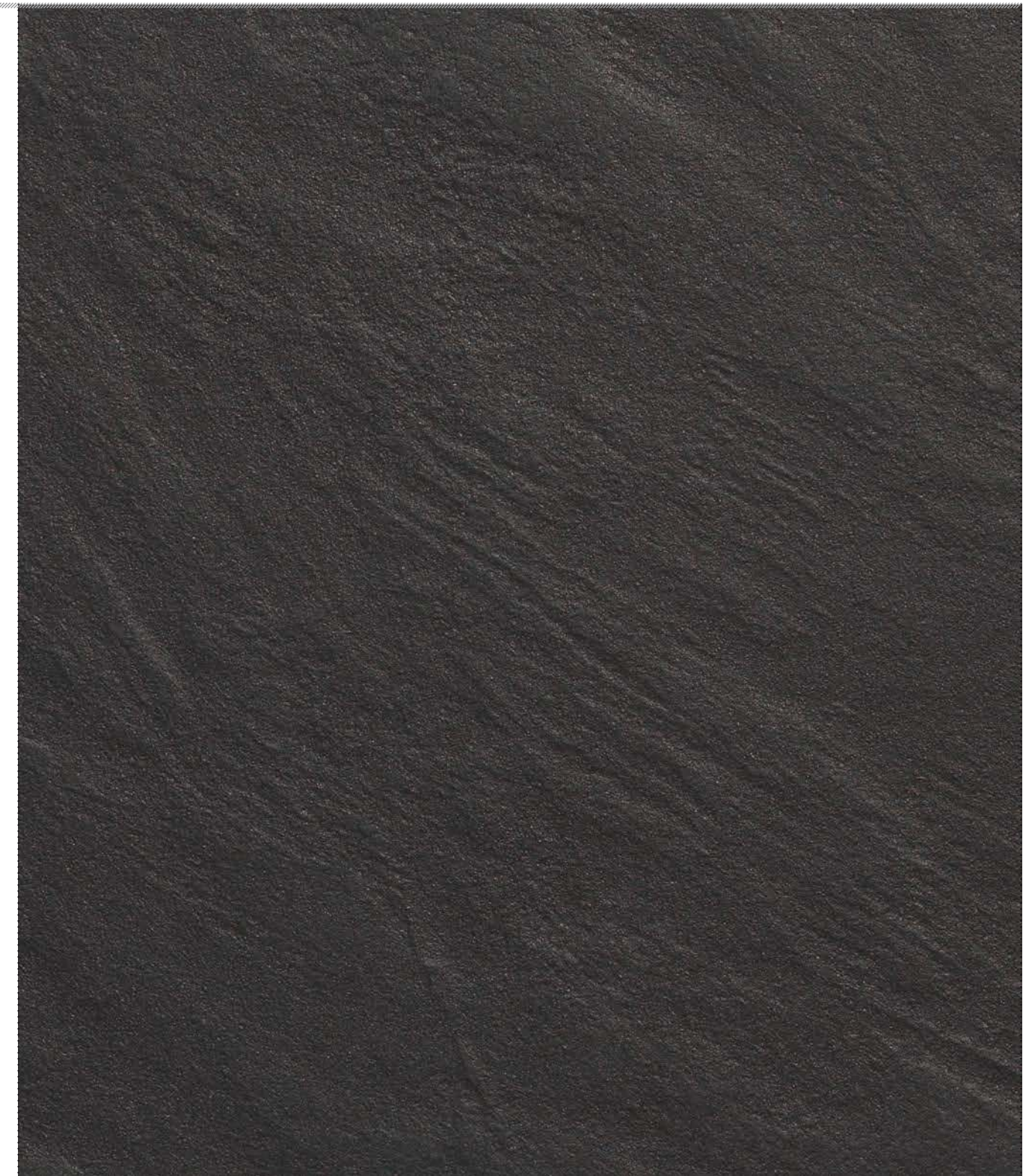

Detalle a escala 1:1 ~ Detail scale 1:1 ~ Detail échelle 1:1 ~ Maßstab 1:1

	RÚSTICO
BLANCO	●
NEGRO	●



≡ Mosaico Mix Onix Negro.



≈ Onix Negro 30x60 rústico + Muro Onix Negro.



≈ Onix Blanco 45x90 rústico.

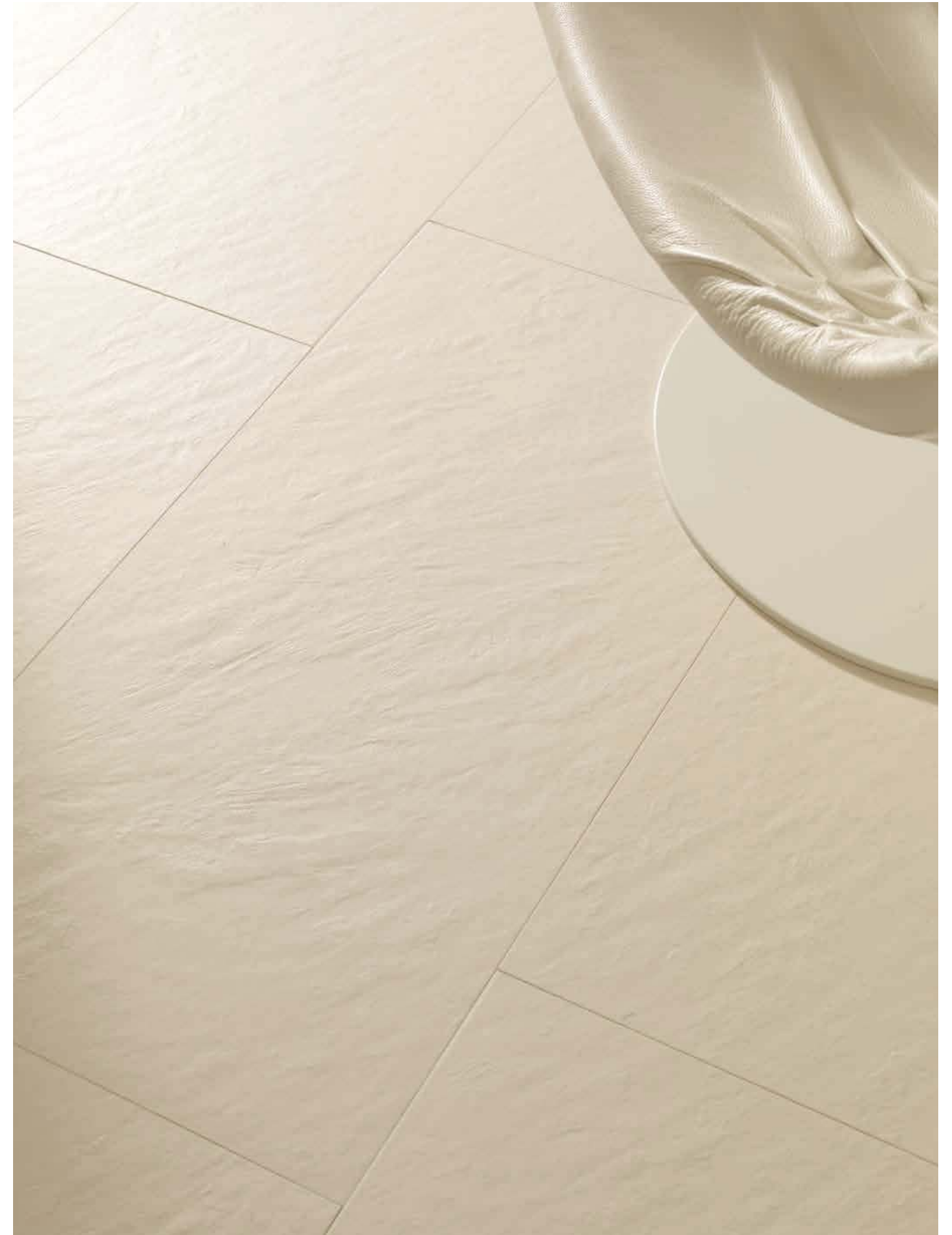

## E07 BLANCO

30x60 cm. (12x24") · RÚSTICO



### ACABADOS / FINISHES

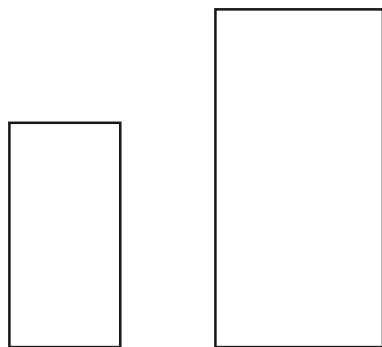

Rústico B-46  
30 x 60 cm  
(12" x 24")

Rústico B-68  
45 x 90 cm  
(18" x 36")

### PACKING LIST

PIEZAS BASE~BASIC TILES~ÉLÉMENTS DE BASE~GRUNDFLIESEN

CM	SIZE	ACABADO/FINISH	PIEZAS CAJA/ PIECES BOX	KG CAJA	M² CAJA	SQFT BOX	CAJAS/BOXES EUROPALET	M² EUROPALET	SQFT EUROPALLET	KG EUROPALET
30 x 60	12" x 24"	RÚSTICO	6	24,00	1,08	11,62	48	51,84	558,00	1179,00
45 x 90	18" x 36"	RÚSTICO	2	20,50	0,81	8,72	39	31,59	340,03	826,50

## E01 NEGRO



30x60 cm. (12x24") · RÚSTICO



### ACABADOS / FINISHES

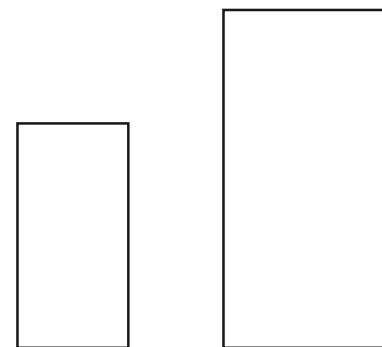

Rústico B-46  
30 x 60 cm  
(12" x 24")

Rústico B-68  
45 x 90 cm  
(18" x 36")

### PACKING LIST

PIEZAS BASE~BASIC TILES~ÉLÉMENTS DE BASE~GRUNDFLIESEN

CM	SIZE	ACABADO/FINISH	PIEZAS CAJA/ PIECES BOX	KG CAJA	M² CAJA	SQFT BOX	CAJAS/BOXES EUROPALET	M² EUROPALET	SQFT EUROPALLET	KG EUROPALET
30 x 60	12" x 24"	RÚSTICO	6	24,00	1,08	11,62	48	51,84	558,00	1179,00
45 x 90	18" x 36"	RÚSTICO	2	20,50	0,81	8,72	39	31,59	340,03	826,50

PIEZAS COMPLEMENTARIAS≈ACCESSORIES≈ACCESSOIRES ET DECORATIONS≈FORMTEILE

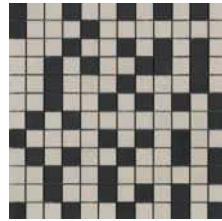

MOSAICO MIX  
ONIX BLANCO  
30 x 30 cm (12" x 12")  
P-16

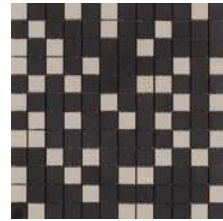

MOSAICO MIX  
ONIX NEGRO  
30 x 30 cm (12" x 12")  
P-16



MURO ONIX  
BLANCO  
30 x 30 cm (12" x 12")  
P-14



MURO ONIX  
NEGRO  
30 x 30 cm (12" x 12")  
P-14

≈ Muro Onix Negro.

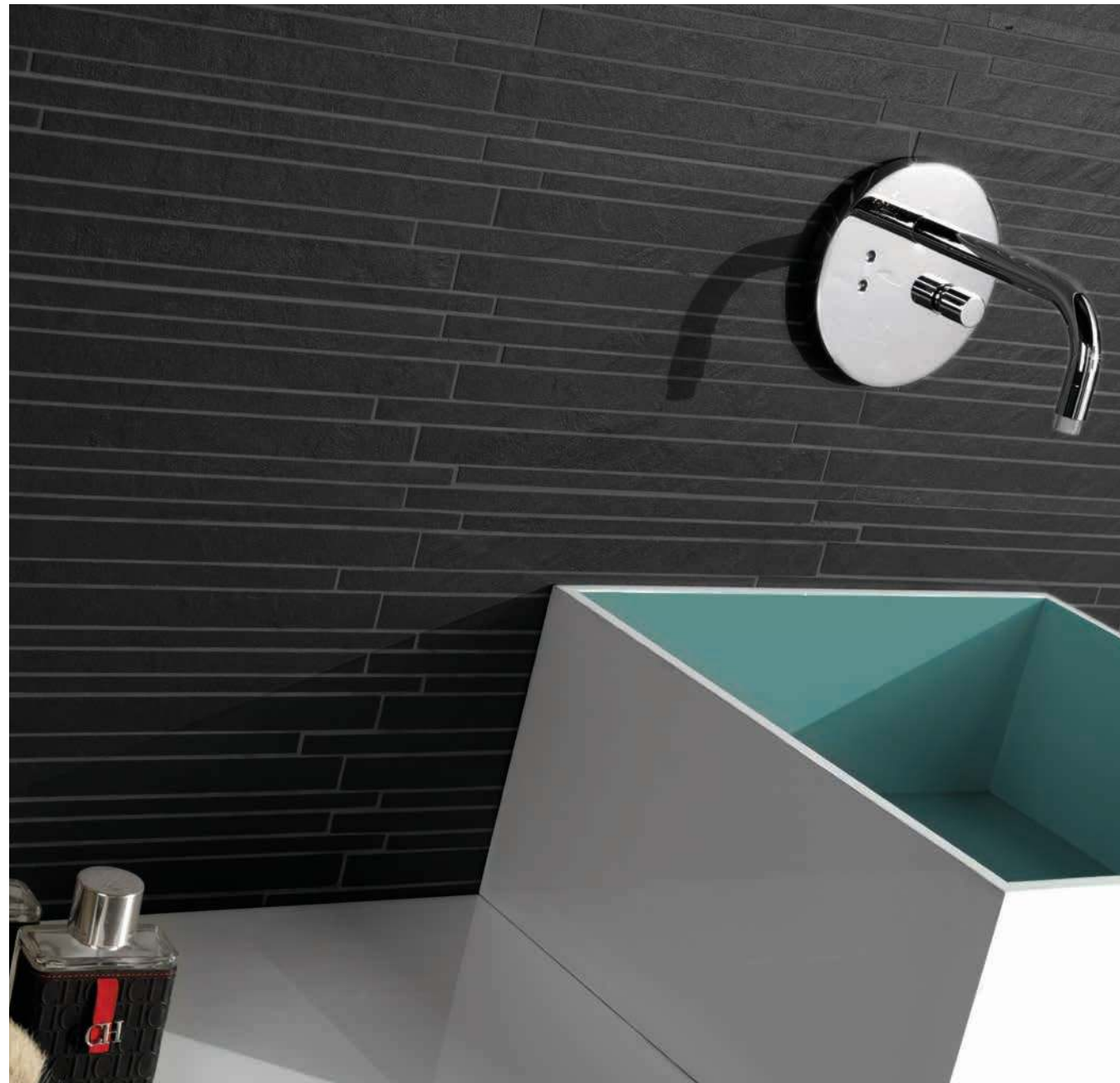

PIEZAS COMPLEMENTARIAS≈ACCESSORIES≈ACCESSOIRES ET DECORATIONS≈FORMTEILE

PACKING LIST

COMPLEMENTOS DECORATIVOS≈DECORATIVE ACCESSORIES≈COMPLÉMENTS DE DÉCORATION≈FORMTEILE

PIEZA/PIECE	CM	SIZE	PRECIO/ PRICE
Mosaico Mix Onix Blanco	30x30	12" x 12"	P-16
Mosaico Mix Onix Negro	30x30	12" x 12"	P-16
Muro Onix Blanco	30x30	12" x 12"	P-14
Muro Onix Negro	30x30	12" x 12"	P-14

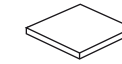

**Taco**  
*Insert*  
8 x 8 cm (3,2" x 3,2")

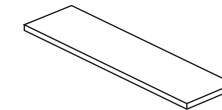

**Listel**  
*Listel*  
8 x 45 cm (3,2" x 18")  
8 x 60 cm (3,2" x 24")  
8 x 90 cm (3,2" x 36")

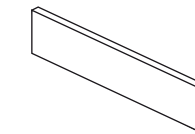

**Rodapié Cortado**  
*Straight skirting*  
8 x 45 cm (3,2" x 18")  
8 x 60 cm (3,2" x 24")  
8 x 90 cm (3,2" x 36")

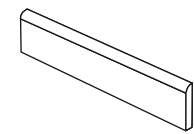

**Rodapié Canto Romo**  
*Skirting bullnose*  
8 x 45 cm (3,2" x 18")  
8 x 60 cm (3,2" x 24")  
8 x 90 cm (3,2" x 36")

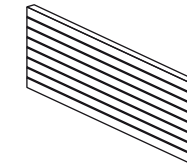

**Incisión**  
*Incision*  
30 x 60 cm (12" x 24")

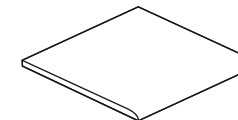

**Canto Romo**  
*Rounded edge piece*  
30 x 60 cm (12" x 24")  
45 x 90 cm (18" x 36")

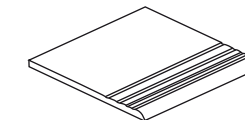

**Peldaño Ranurado**  
*Grooved stair tread*  
30 x 60 cm (12" x 24")  
45 x 90 cm (18" x 36")

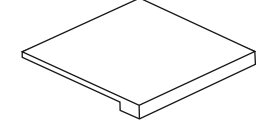

**Peldaño Elit con o sin ranura**  
*Grooved Elit Stair/Plain Elit Stair*  
30 x 60 cm (12" x 24")  
45 x 90 cm (18" x 36")

PACKING LIST





PIEZAS ESPECIALES≈SPECIAL ACCESSORIES≈ÉLÉMENTS SPÉCIAUX≈SPEZIALTEILE

PIEZA/PIECE	CM	SIZE	ACABADO/ FINISH	PRECIO/ PRICE	PIEZA/PIECE	CM	SIZE	ACABADO/ FINISH	PRECIO/ PRICE
Taco - Insert	8x8	3,2" x 3,2"	RÚSTICO	P-02	Canto Romo 2 lados - Rounded edge piece 2 sides	30x60	12" x 24"	RÚSTICO	P-23
Rodapié Cortado - Straight skirting	8x45	3,2" x 18"	RÚSTICO	P-04	Canto Romo 2 lados - Rounded edge piece 2 sides	45x90	18" x 36"	RÚSTICO	P-49
Rodapié Cortado - Straight skirting	8x60	3,2" x 24"	RÚSTICO	P-05	Peldaño Ranurado - Grooved stair tread	30x60	12" x 24"	RÚSTICO	P-16
Rodapié Cortado - Straight skirting	8x90	3,2" x 36"	RÚSTICO	P-08	Peldaño Ranurado - Grooved stair tread	45x90	18" x 36"	RÚSTICO	P-38
Rodapié Canto Romo - Skirting bullnose	8x45	3,2" x 18"	RÚSTICO	P-05	Peldaño Ranurado Esquina - Grooved stair tread corner	30x60	12" x 24"	RÚSTICO	P-23
Rodapié Canto Romo - Skirting bullnose	8x60	3,2" x 24"	RÚSTICO	P-06	Peldaño Ranurado Esquina - Grooved stair tread corner	45x90	18" x 36"	RÚSTICO	P-49
Rodapié Canto Romo - Skirting bullnose	8x90	3,2" x 36"	RÚSTICO	P-10	Peldaño Elit (lado 30) - Elit step (12" side)	30x60	12" x 24"	RÚSTICO	P-28
Listel	8x45	3,2" x 18"	RÚSTICO	P-04	Peldaño Elit (lado 60) - Elit step (24" side)	30x60	12" x 24"	RÚSTICO	P-46
Listel	8x60	3,2" x 24"	RÚSTICO	P-05	Peldaño Elit Esquina - Elit step corner	30x60	12" x 24"	RÚSTICO	P-67
Listel	8x90	3,2" x 36"	RÚSTICO	P-08	Peldaño Elit (lado 45) - Elit step (18" side)	45x90	18" x 36"	RÚSTICO	P-57
Incisión	30x60	12" x 24"	RÚSTICO	P-13	Peldaño Elit (lado 90) - Elit step (36" side)	45x90	18" x 36"	RÚSTICO	P-84
Canto Romo 1 lado - Rounded edge piece 1 side	30x60	12" x 24"	RÚSTICO	P-16	Peldaño Elit Esquina - Elit step corner	45x90	18" x 36"	RÚSTICO	P-118
Canto Romo 1 lado - Rounded edge piece 1 side	45x90	18" x 36"	RÚSTICO	P-38					

Estas piezas se venden por unidad, a excepción de los rodapiés que se venden en cajas de 10 uds.  
These items are sold by pieces with the exception of the skirtings which are sold by boxes of 10 pieces each.  
Unité de vente à la pièce, sauf les plinthes vendus à la boîte de 10 unités.  
Die Formteile sind pro Stück verkauft außer die Sockel, die pro Karton mit 10 Stück verkauft sind.

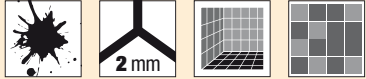
≈ Otranto Gris 45x90 lucidato + Otranto Nácar 45x90 lucidato.



CARACTERÍSTICAS TÉCNICAS TECHNICAL CHARACTERISTICS	MODELOS MODELS ≈	ACABADOS FINISHES ≈													
	≈	≈ MATE ≈	≈ LUCIDATO ≈												
<p><b>FORMATOS≈SIZES</b></p> <p>45 x 90 cm (18" x 36") 60 x 60 cm (24" x 24")</p>   <p>Consulte página 10≈See page 10≈ Voir page 10≈Sehen Sie Seite 10</p> <p><b>ÁMBITOS DE USO≈AREA OF USE</b></p> <p><b>MATE / LUCIDATO</b> Idóneo para zonas interiores secas. <i>Suitable for dry indoor areas.</i> <i>Idéal pour application intérieure sèche.</i> <i>Ideal für trockene Innenräume.</i></p> <p><b>NORMA≈NORM</b></p> <p>NORMA UNE-ENV 12633:2003 - Otranto Mate: Clase 1 - Otranto Lucidato: Clase 1</p>	<p>≈</p> <p>NACAR</p>  <p>≈</p> <p>GRIS</p>  <p>≈</p> <p>NEGRO</p> 														
		<p>Detalle a escala 1:1 ≈ Detail scale 1:1 ≈ Detail échelle 1:1 ≈ Maßstab 1:1</p> <table border="1"> <thead> <tr> <th></th> <th>MATE</th> <th>LUCIDATO</th> </tr> </thead> <tbody> <tr> <td>NACAR</td> <td>●</td> <td>●</td> </tr> <tr> <td>GRIS</td> <td>●</td> <td>●</td> </tr> <tr> <td>NEGRO</td> <td>●</td> <td>●</td> </tr> </tbody> </table>			MATE	LUCIDATO	NACAR	●	●	GRIS	●	●	NEGRO	●	●
	MATE	LUCIDATO													
NACAR	●	●													
GRIS	●	●													
NEGRO	●	●													

# OTRANTO

PORCELÁNICO~PORCELAIN TILE~GRÉS CÉRAME~FEINSTEINZEUG

≈ Otranto Nacar 45x90 lucidato + Mosaico Mix Otranto Nacar



≈ Otranto Negro 60x60 lucidato

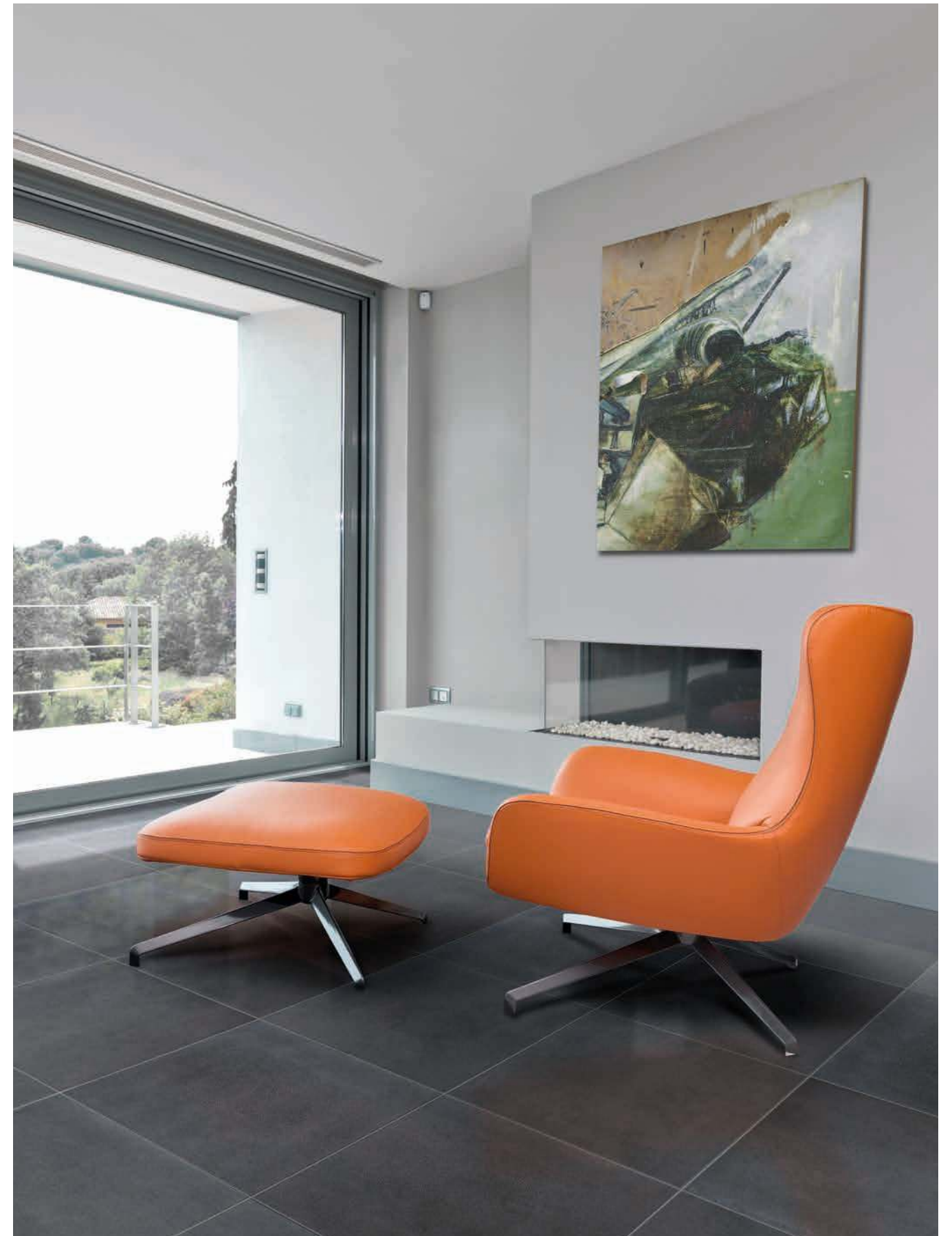

# OTRANTO

PORCELÁNICO~PORCELAIN TILE~GRÉS CÉRAME~FEINSTEINZEUG

## O05 NACAR

45x90 cm. (18x36") · LUCIDATO



ACABADOS / FINISHES

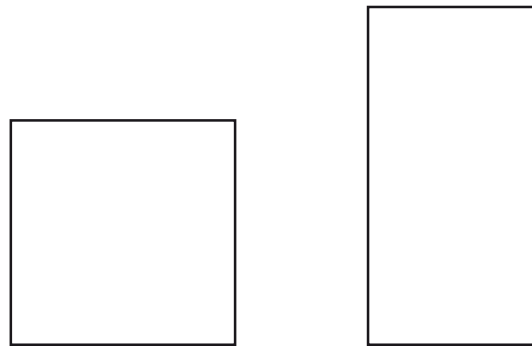

Mate B-55  
Lucidato B-64  
60 x 60 cm  
(24" x 24")

Mate B-62  
Lucidato B-71  
45 x 90 cm  
(18" x 36")

### PACKING LIST

PIEZAS BASE~BASIC TILES~ÉLÉMENTS DE BASE~GRUNDFLIESEN

CM	SIZE	ACABADO/FINISH	PIEZAS CAJA/ PIECES BOX	KG CAJA	M² CAJA	SQFT BOX	CAJAS/BOXES EUROPALET	M² EUROPALET	SQFT EUROPALET	KG EUROPALET
60 x 60	24" x 24"	TODOS	4	33,20	1,44	15,50	32	46,08	496,00	1089,40
45 x 90	18" x 36"	TODOS	2	20,50	0,81	8,72	39	31,59	340,03	826,50

## O01 GRIS

45x90 cm. (18x36") · LUCIDATO



ACABADOS / FINISHES

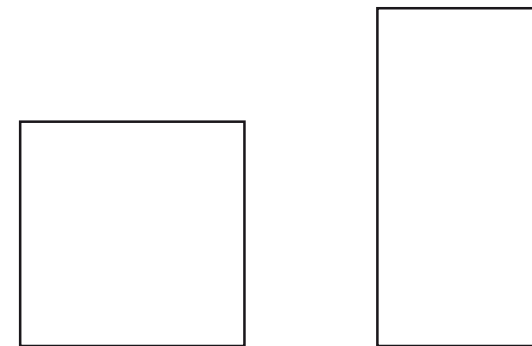

Mate B-48  
Lucidato B-57  
60 x 60 cm  
(24" x 24")

Mate B-55  
Lucidato B-64  
45 x 90 cm  
(18" x 36")

### PACKING LIST

PIEZAS BASE~BASIC TILES~ÉLÉMENTS DE BASE~GRUNDFLIESEN

CM	SIZE	ACABADO/FINISH	PIEZAS CAJA/ PIECES BOX	KG CAJA	M² CAJA	SQFT BOX	CAJAS/BOXES EUROPALET	M² EUROPALET	SQFT EUROPALET	KG EUROPALET
60 x 60	24" x 24"	TODOS	4	33,20	1,44	15,50	32	46,08	496,00	1089,40
45 x 90	18" x 36"	TODOS	2	20,50	0,81	8,72	39	31,59	340,03	826,50



# OTRANTO

PORCELÁNICO≈PORCELAIN TILE≈GRÉS CÉRAMÉ≈FEINSTEINZEUG

DESTONIFICACIÓN INTENCIONADA≈INTENTIONALLY NON-HOMOGENEOUS COLOUR≈  
DES VARIATIONS DE NUANCES INTENTIONNÉES≈DESIGNEMÄÙE ENTFÄRBUNG

## O09 NEGRO ≡

45x90 cm. (18x36") · LUCIDATO



### ACABADOS / FINISHES

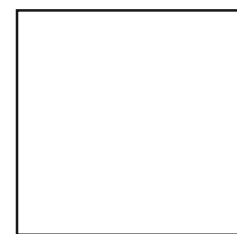

Mate B-48  
Lucidato B-57  
60 x 60 cm  
(24" x 24")

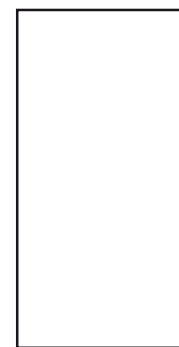

Mate B-55  
Lucidato B-64  
45 x 90 cm  
(18" x 36")

### PACKING LIST

PIEZAS BASE≈BASIC TILES≈ELÉMENTS DE BASE≈GRUNDFLIESEN

CM	SIZE	ACABADO/FINISH	PIEZAS CAJA/ PIECES BOX	KG CAJA	M² CAJA	SQFT BOX	CAJAS/BOXES EUROPALET	M² EUROPALET	SQFT EUROPALET	KG EUROPALET
60 x 60	24" x 24"	TODOS	4	33,20	1,44	15,50	32	46,08	496,00	1089,40
45 x 90	18" x 36"	TODOS	2	20,50	0,81	8,72	39	31,59	340,03	826,50

## PIEZAS COMPLEMENTARIAS≈ACCESSORIES≈ACCESSOIRES ET DECORATIONS≈FORMTEILE



MOSAICO MIX  
OTRANTO NACAR  
30 x 30 cm (12" x 12")  
P-13



MOSAICO MIX  
OTRANTO GRIS  
30 x 30 cm (12" x 12")  
P-13



MOSAICO MIX  
OTRANTO NEGRO  
30 x 30 cm (12" x 12")  
P-13

### PACKING LIST

COMPLEMENTOS DECORATIVOS≈DECORATIVE ACCESSORIES≈COMPLÉMENTS DE DÉCORATION≈FORMTEILE

PIEZA/PIECE	CM	SIZE	ACABADO/ FINISH	PRECIO/ PRICE
Mosaico Mix Otranto Nacar	30x30	12" x 12"	MATE/LUCIDATO	P-13
Mosaico Mix Otranto Gris	30x30	12" x 12"	MATE/LUCIDATO	P-13
Mosaico Mix Otranto Negro	30x30	12" x 12"	MATE/LUCIDATO	P-13

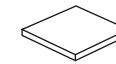

**Taco**  
*Insert*  
8 x 8 cm (3,2" x 3,2")

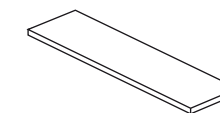

**Listel**  
*Listel*  
8 x 45 cm (3,2" x 18")  
8 x 60 cm (3,2" x 24")  
8 x 90 cm (3,2" x 36")

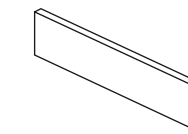

**Rodapié Cortado**  
*Straight skirting*  
8 x 45 cm (3,2" x 18")  
8 x 60 cm (3,2" x 24")  
8 x 90 cm (3,2" x 36")

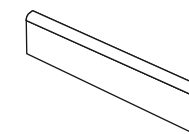

**Rodapié Canto Romo**  
*Skirting bullnose*  
8 x 45 cm (3,2" x 18")  
8 x 60 cm (3,2" x 24")  
8 x 90 cm (3,2" x 36")

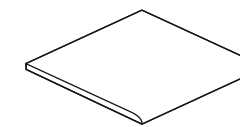

**Canto Romo**  
*Rounded edge piece*  
45 x 90 cm (18" x 36")  
60 x 60 cm (24" x 24")

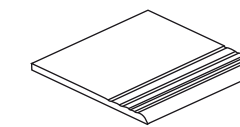

**Peldaño Ranurado**  
*Grooved stair tread*  
45 x 90 cm (18" x 36")  
60 x 60 cm (24" x 24")

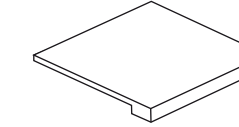

**Peldaño Elit con o sin ranura**  
*Grooved Elit Stair/Plain Elit Stair*  
45 x 90 cm (18" x 36")  
60 x 60 cm (24" x 24")

### PACKING LIST

PIEZAS ESPECIALES≈SPECIAL ACCESSORIES≈ELÉMENTS SPÉCIAUX≈SPEZIALTEILE

PIEZA/PIECE	CM	SIZE	ACABADO/ FINISH	PRECIO/ PRICE	PIEZA/PIECE	CM	SIZE	ACABADO/ FINISH	PRECIO/ PRICE
Taco - Insert	8x8	3,2" x 3,2"	TODOS	P-02	Canto Romo 2 lados - Rounded edge piece 2 sides	45x90	18" x 36"	TODOS	P-49
Rodapié Cortado - Straight skirting	8x45	3,2 x 18"	TODOS	P-04	Canto Romo 2 lados - Rounded edge piece 2 sides	60x60	24" x 24"	TODOS	P-38
Rodapié Cortado - Straight skirting	8x60	3,2 x 24"	TODOS	P-05	Peldaño Ranurado - Grooved stair tread	45x90	18" x 36"	TODOS	P-38
Rodapié Cortado - Straight skirting	8x90	3,2 x 36"	TODOS	P-08	Peldaño Ranurado - Grooved stair tread	60x60	24" x 24"	TODOS	P-31
Rodapié Canto Romo - Skirting bullnose	8x45	3,2 x 18"	TODOS	P-05	Peldaño Ranurado Esquina - Grooved stair tread corner	45x90	18" x 36"	TODOS	P-49
Rodapié Canto Romo - Skirting bullnose	8x60	3,2" x 24"	TODOS	P-06	Peldaño Ranurado Esquina - Grooved stair tread corner	60x60	24" x 24"	TODOS	P-38
Rodapié Canto Romo - Skirting bullnose	8x90	3,2 x 36"	TODOS	P-10	Peldaño Elit (lado 45) - Elit step (18" side)	45x90	18" x 36"	TODOS	P-57
Listel	8x45	3,2" x 18"	TODOS	P-04	Peldaño Elit (lado 90) - Elit step (36" side)	45x90	18" x 36"	TODOS	P-84
Listel	8x60	3,2" x 24"	TODOS	P-05	Peldaño Elit - Elit step	60x60	24" x 24"	TODOS	P-62
Listel	8x90	3,2" x 36"	TODOS	P-08	Peldaño Elit Esquina - Elit step corner	45x90	18" x 36"	TODOS	P-118
Canto Romo 1 lado - Rounded edge piece 1 side	45x90	18" x 36"	TODOS	P-38	Peldaño Elit Esquina - Elit step corner	60x60	24" x 24"	TODOS	P-104
Canto Romo 1 lado - Rounded edge piece 1 side	60x60	24" x 24"	TODOS	P-31					

Estas piezas se venden por unidad, a excepción de los rodapiés que se venden en cajas de 10 uds.

These items are sold by pieces with the exception of the skirtings which are sold by boxes of 10 pieces each.

Unité de vente à la pièce, sauf les plinthes vendus à la boîte de 10 unités.

Die Formteile sind pro Stück verkauft außer die Sockel, die pro Karton mit 10 Stück verkauft sind.

≈ Perseo Grafito 45x90 lucidato + Muro Grafito.





# PERSEO

PORCELÁNICO~PORCELAIN TILE~GRÉS CÉRAME~FEINSTEINZEUG

∨ Perseo Beige 60x60 lucidato.



# PERSEO

PORCELÁNICO~PORCELAIN TILE~GRÉS CÉRAME~FEINSTEINZEUG

∨ Perseo Grafito 45x90 mate.



# PERSEO

PORCELÁNICO~PORCELAIN TILE~GRÉS CÉRAME~FEINSTEINZEUG

Perseo Gris 60x60 lucidato.



P22 BEIGE

30x60 cm. (12x24") · MATE



ACABADOS / FINISHES

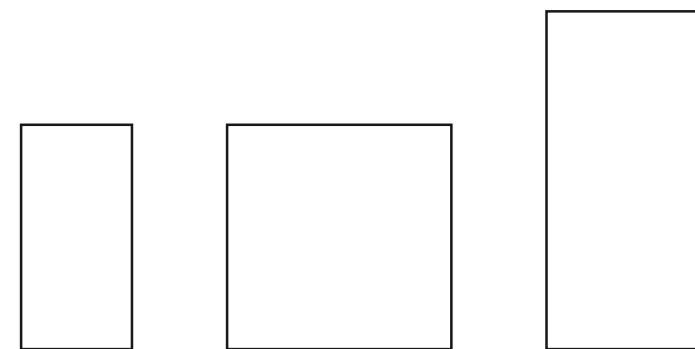

Mate B-44 Lucidato B-56 30 x 60 cm (12" x 24")	Mate B-54 Lucidato B-62 60 x 60 cm (24" x 24")	Mate B-58 Lucidato B-66 45 x 90 cm (18" x 36")
---	---	---

## PACKING LIST

PIEZAS BASE~BASIC TILES~ÉLÉMENTS DE BASE~GRUNDFLIESEN

CM	SIZE	ACABADO/FINISH	PIEZAS CAJA/ PIECES BOX	KG CAJA	M² CAJA	SQFT BOX	CAJAS/BOXES EUROPALET	M² EUROPALET	SQFT EUROPALET	KG EUROPALET
30 x 60	12" x 24"	RÚSTICO	6	24,00	1,08	11,62	48	51,84	558,00	1179,00
60 x 60	24" x 24"	MATE	4	33,20	1,44	15,50	32	46,08	496,00	1089,40
45 x 90	18" x 36"	RÚSTICO	2	20,50	0,81	8,72	39	31,59	340,03	826,50

# PERSEO

PORCELÁNICO≈PORCELAIN TILE≈GRÉS CÉRAME≈FEINSTEINZEUG

## P21 GRIS

Reciclado

30x60 cm. (12x24") · MATE



### ACABADOS / FINISHES

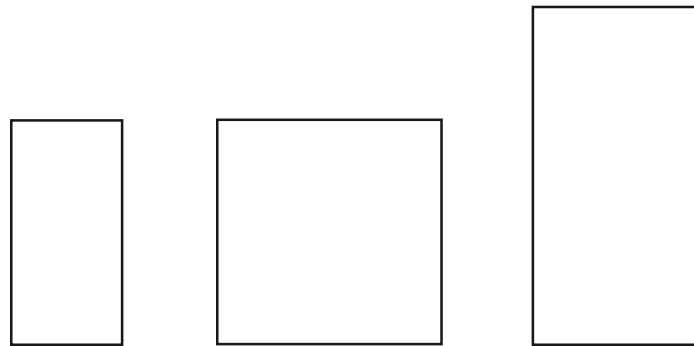

Mate B-44 Lucidato B-56 30 x 60 cm (12" x 24")	Mate B-54 Lucidato B-62 60 x 60 cm (24" x 24")	Mate B-58 Lucidato B-66 45 x 90 cm (18" x 36")
---	---	---

### PACKING LIST

PIEZAS BASE≈BASIC TILES≈ELÉMENTS DE BASE≈GRUNDFLIESEN

CM	SIZE	ACABADO/FINISH	PIEZAS CAJA/ PIECES BOX	KG CAJA	M² CAJA	SQFT BOX	CAJAS/BOXES EUROPALET	M² EUROPALET	SQFT EUROPALLET	KG EUROPALET
30 x 60	12" x 24"	RÚSTICO	6	24,00	1,08	11,62	48	51,84	558,00	1179,00
60 x 60	24" x 24"	MATE	4	33,20	1,44	15,50	32	46,08	496,00	1089,40
45 x 90	18" x 36"	RÚSTICO	2	20,50	0,81	8,72	39	31,59	340,03	826,50

## P24 GRAFITO

30x60 cm. (12x24") · MATE



### ACABADOS / FINISHES

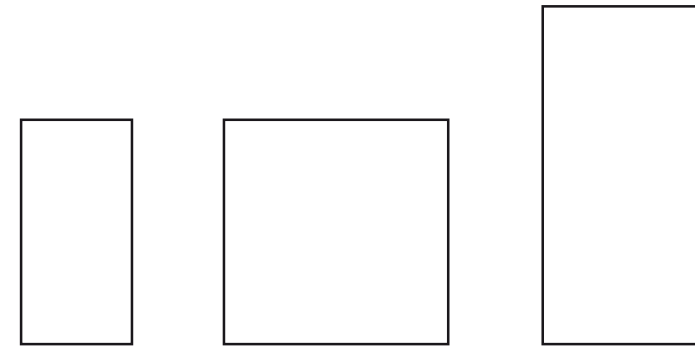

Mate B-44 Lucidato B-56 30 x 60 cm (12" x 24")	Mate B-54 Lucidato B-62 60 x 60 cm (24" x 24")	Mate B-58 Lucidato B-66 45 x 90 cm (18" x 36")
---	---	---

### PACKING LIST

PIEZAS BASE≈BASIC TILES≈ELÉMENTS DE BASE≈GRUNDFLIESEN

CM	SIZE	ACABADO/FINISH	PIEZAS CAJA/ PIECES BOX	KG CAJA	M² CAJA	SQFT BOX	CAJAS/BOXES EUROPALET	M² EUROPALET	SQFT EUROPALLET	KG EUROPALET
30 x 60	12" x 24"	RÚSTICO	6	24,00	1,08	11,62	48	51,84	558,00	1179,00
60 x 60	24" x 24"	MATE	4	33,20	1,44	15,50	32	46,08	496,00	1089,40
45 x 90	18" x 36"	RÚSTICO	2	20,50	0,81	8,72	39	31,59	340,03	826,50

# PERSEO

PORCELÁNICO~PORCELAIN TILE~GRÉS CÉRAME~FEINSTEINZEUG

## PIEZAS COMPLEMENTARIAS~ACCESSORIES~ACCESSOIRES ET DECORATIONS~FORMTEILE



MOSAICO 5,8x5,8  
PERSEO BEIGE  
LUCIDATO  
30 x 30 cm (12" x 12")  
P-12



MOSAICO 5,8x5,8  
PERSEO GRIS  
LUCIDATO  
30 x 30 cm (12" x 12")  
P-12



MOSAICO 5,8x5,8  
PERSEO GRAFITO  
LUCIDATO  
30 x 30 cm (12" x 12")  
P-12



MURO  
PERSEO BEIGE  
LUCIDATO  
30 x 30 cm (12" x 12")  
P-14



MURO  
PERSEO GRIS  
LUCIDATO  
30 x 30 cm (12" x 12")  
P-14

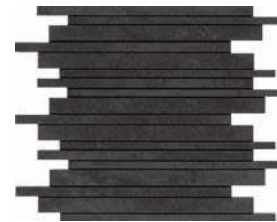

MURO  
PERSEO GRAFITO  
LUCIDATO  
30 x 30 cm (12" x 12")  
P-14

≈ Perseo Gris 60x60 lucidato.



## PIEZAS COMPLEMENTARIAS~ACCESSORIES~ACCESSOIRES ET DECORATIONS~FORMTEILE

### PACKING LIST

COMPLEMENTOS DECORATIVOS~DECORATIVE ACCESSORIES~COMPLÉMENTS DE DÉCORATION~FORMTEILE

PIEZA/PIECE	CM	SIZE	ACABADO/ FINISH	PRECIO/ PRICE	PIEZA/PIECE	CM	SIZE	ACABADO/ FINISH	PRECIO/ PRICE
Mosaico 5,8x5,8 Perseo Beige	30x30	12" x 12"	LUCIDATO	P-12	Muro Perseo Beige	30x30	12" x 12"	LUCIDATO	P-14
Mosaico 5,8x5,8 Perseo Gris	30x30	12" x 12"	LUCIDATO	P-12	Muro Perseo Gris	30x30	12" x 12"	LUCIDATO	P-14
Mosaico 5,8x5,8 Perseo Grafito	30x30	12" x 12"	LUCIDATO	P-12	Muro Perseo Grafito	30x30	12" x 12"	LUCIDATO	P-14

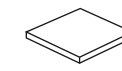

**Taco**  
*Insert*

8 x 8 cm (3,2" x 3,2")

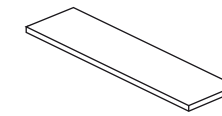

**Listel**  
*Listel*

8 x 30 cm (3,2" x 12")  
8 x 45 cm (3,2" x 18")  
8 x 60 cm (3,2" x 24")  
8 x 90 cm (3,2" x 36")

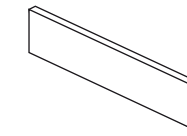

**Rodapié Cortado**  
*Straight skirting*

8 x 30 cm (3,2" x 12")  
8 x 45 cm (3,2" x 18")  
8 x 60 cm (3,2" x 24")  
8 x 90 cm (3,2" x 36")

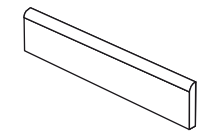

**Rodapié Canto Romo**  
*Skirting bullnose*

8 x 30 cm (3,2" x 12")  
8 x 45 cm (3,2" x 18")  
8 x 60 cm (3,2" x 24")  
8 x 90 cm (3,2" x 36")

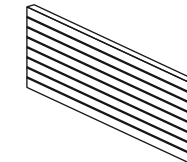

**Incisión**  
*Incision*

30 x 60 cm (12" x 24")

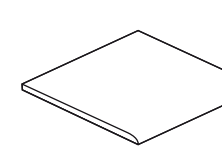

**Canto Romo**  
*Rounded edge piece*

30 x 60 cm (12" x 24")  
45 x 90 cm (18" x 36")  
60 x 60 cm (24" x 24")

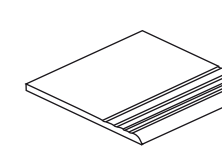

**Peldaño Ranurado**  
*Grooved stair tread*

30 x 60 cm (12" x 24")  
45 x 90 cm (18" x 36")  
60 x 60 cm (24" x 24")

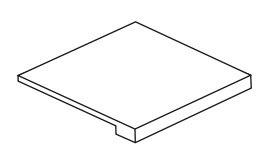

**Peldaño Elit con o sin ranura**  
*Grooved Elit Stair/Plain Elit Stair*

30 x 60 cm (12" x 24")  
45 x 90 cm (18" x 36")  
60 x 60 cm (24" x 24")

### PACKING LIST

PIEZAS ESPECIALES~SPECIAL ACCESSORIES~ÉLÉMENTS SPÉCIAUX~SPEZIALTEILE

PIEZA/PIECE	CM	SIZE	ACABADO/ FINISH	PRECIO/ PRICE	PIEZA/PIECE	CM	SIZE	ACABADO/ FINISH	PRECIO/ PRICE
Taco - Insert	8x8	3,2" x 3,2"	TODOS	P-02	Canto Romo 2 lados - Rounded edge piece 2 sides	30x60	12" x 24"	TODOS	P-25
Rodapié Cortado - Straight skirting	8x30	3,2" x 12"	TODOS	P-02	Canto Romo 2 lados - Rounded edge piece 2 sides	45x90	18" x 36"	TODOS	P-49
Rodapié Cortado - Straight skirting	8x45	3,2" x 18"	TODOS	P-04	Canto Romo 2 lados - Rounded edge piece 2 sides	60x60	24" x 24"	TODOS	P-38
Rodapié Cortado - Straight skirting	8x60	3,2" x 24"	TODOS	P-05	Peldaño Ranurado - Grooved stair tread	30x60	12" x 24"	TODOS	P-18
Rodapié Cortado - Straight skirting	8x90	3,2" x 36"	TODOS	P-08	Peldaño Ranurado - Grooved stair tread	45x90	18" x 36"	TODOS	P-38
Rodapié Canto Romo - Skirting bullnose	8x30	3,2" x 12"	TODOS	P-03	Peldaño Ranurado - Grooved stair tread	60x60	24" x 24"	TODOS	P-31
Rodapié Canto Romo - Skirting bullnose	8x45	3,2" x 18"	TODOS	P-05	Peldaño Ranurado Esquina - Grooved stair tread corner	30x60	12" x 24"	TODOS	P-25
Rodapié Canto Romo - Skirting bullnose	8x60	3,2" x 24"	TODOS	P-06	Peldaño Ranurado Esquina - Grooved stair tread corner	45x90	18" x 36"	TODOS	P-49
Rodapié Canto Romo - Skirting bullnose	8x90	3,2" x 36"	TODOS	P-10	Peldaño Ranurado Esquina - Grooved stair tread corner	60x60	24" x 24"	TODOS	P-38
Listel	8x30	3,2" x 12"	TODOS	P-02	Peldaño Elit (lado 30) - Elit step (12" side)	30x60	12" x 24"	TODOS	P-30
Listel	8x45	3,2" x 18"	TODOS	P-04	Peldaño Elit (lado 60) - Elit step (24" side)	30x60	12" x 24"	TODOS	P-48
Listel	8x60	3,2" x 24"	TODOS	P-05	Peldaño Elit (lado 45) - Elit step (18" side)	45x90	18" x 36"	TODOS	P-57
Listel	8x90	3,2" x 36"	TODOS	P-08	Peldaño Elit (lado 90) - Elit step (36" side)	45x90	18" x 36"	TODOS	P-84
Incisión	30x60	12" x 24"	TODOS	P-14	Peldaño Elit - Elit step	60x60	24" x 24"	TODOS	P-62
Canto Romo 1 lado - Rounded edge piece 1 side	30x60	12" x 24"	TODOS	P-18	Peldaño Elit Esquina - Elit step corner	30x60	12" x 24"	TODOS	P-69
Canto Romo 1 lado - Rounded edge piece 1 side	45x90	18" x 36"	TODOS	P-38	Peldaño Elit Esquina - Elit step corner	45x90	18" x 36"	TODOS	P-118
Canto Romo 1 lado - Rounded edge piece 1 side	60x60	24" x 24"	TODOS	P-31	Peldaño Elit Esquina - Elit step corner	60x60	24" x 24"	TODOS	P-104

Estas piezas se venden por unidad, a excepción de los rodapiés que se venden en cajas de 10 uds.

These items are sold by pieces with the exception of the skirtings which are sold by boxes of 10 pieces each.

Unité de vente à la pièce, sauf les plinthes vendus à la boîte de 10 unités.

Die Formteile sind pro Stück verkauft außer die Sockel, die pro Karton mit 10 Stück verkauft sind.











≈ Pórtland Marrón 45x90 lucidato + Pórtland Nacar 30x60 lucidato + Mosaico 2,3x9,8 Pórtland Marrón lucidato.



**CARACTERÍSTICAS TÉCNICAS**  
TECHNICAL CHARACTERISTICS

**FORMATOS~SIZES**  
30 x 60 cm (12" x 24")  
45 x 90 cm (18" x 36")  
60 x 60 cm (24" x 24")



Consulte página 10~See page 10~  
Voir page 10~Sehen Sie Seite 10

**ÁMBITOS DE USO~AREA OF USE**

**MATE / LUCIDATO**  
Idóneo para zonas interiores secas.  
*Suitable for dry indoor areas.*  
*Idéal pour application intérieure sèche.*  
*Ideal für trockene Innenräume.*

**NORMA~NORM**

NORMA UNE-ENV 12633:2003  
- Pórtland Mate: Clase 1  
- Pórtland Lucidato: Clase 1

FORMATO	MATE
30 x 60	U4 P3 E3 C2
60 x 60	U4 P4+ E3 C2

**MODELOS MODELS**

≡  
MARRÓN

≡  
NACAR

≡  
GRIS

≡  
NEGRO

≡ MATE ≡
≡ LUCIDATO ≡



Detalle a escala 1:1 ~ Detail scale 1:1 ~ Detail échelle 1:1 ~ Maßstab 1:1

	MATE	LUCIDATO
MARRÓN	●	●
NACAR	●	●
GRIS	●	●
NEGRO	●	●

# PÓRTLAND

PORCELÁNICO~PORCELAIN TILE~GRÉS CÉRAME~FEINSTEINZEUG

∨ Pórtland Gris 60x60 mate.



# PÓRTLAND

PORCELÁNICO~PORCELAIN TILE~GRÉS CÉRAME~FEINSTEINZEUG

≡ Pórtland Negro 60x60 lucidato.



≡ Pórtland Nacar 60x60 lucidato.



# PÓRTLAND

PORCELÁNICO≈PORCELAIN TILE≈GRÉS CÉRAMÉ≈FEINSTEINZEUG

DESTONIFICACIÓN INTENCIONADA≈INTENTIONALLY NON-HOMOGENEOUS COLOUR≈  
DES VARIATIONS DE NUANCES INTENTIONNÉES≈DESIGNGEMÄÙE ENTFÄRBUNG

## P43 MARRÓN

30x60 cm. (12x24") · MATE



ACABADOS / FINISHES

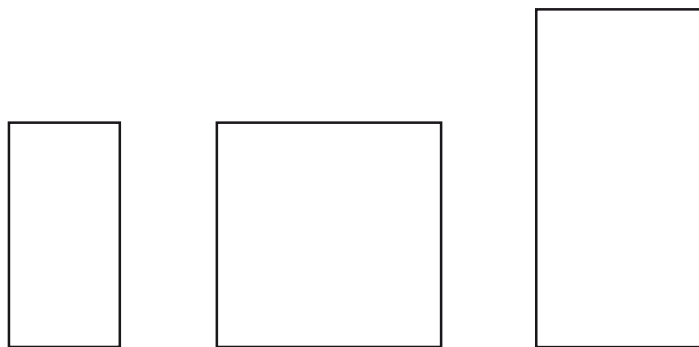

Mate B-44 Lucidato B-56 30 x 60 cm (12" x 24")	Mate B-54 Lucidato B-62 60 x 60 cm (24" x 24")	Mate B-58 Lucidato B-66 45 x 90 cm (18" x 36")
---	---	---

### PACKING LIST

PIEZAS BASE≈BASIC TILES≈ELÉMENTS DE BASE≈GRUNDFLIESEN

CM	SIZE	ACABADO/FINISH	PIEZAS CAJA/ PIECES BOX	KG CAJA	M² CAJA	SQFT BOX	CAJAS/BOXES EUROPALET	M² EUROPALET	SQFT EUROPALLET	KG EUROPALET
30 x 60	12" x 24"	TODOS	6	24,00	1,08	11,62	48	51,84	558,00	1179,00
60 x 60	24" x 24"	TODOS	4	33,20	1,44	15,50	32	46,08	496,00	1089,40
45 x 90	18" x 36"	TODOS	2	20,50	0,81	8,72	39	31,59	340,03	826,50

## P45 NACAR

30x60 cm. (12x24") · MATE



ACABADOS / FINISHES

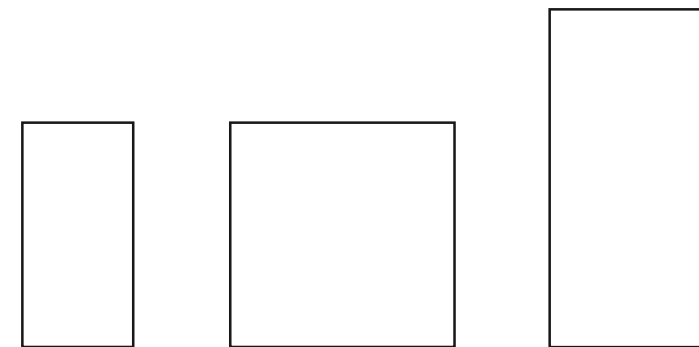

Mate B-44 Lucidato B-56 30 x 60 cm (12" x 24")	Mate B-54 Lucidato B-62 60 x 60 cm (24" x 24")	Mate B-58 Lucidato B-66 45 x 90 cm (18" x 36")
---	---	---

### PACKING LIST

PIEZAS BASE≈BASIC TILES≈ELÉMENTS DE BASE≈GRUNDFLIESEN

CM	SIZE	ACABADO/FINISH	PIEZAS CAJA/ PIECES BOX	KG CAJA	M² CAJA	SQFT BOX	CAJAS/BOXES EUROPALET	M² EUROPALET	SQFT EUROPALLET	KG EUROPALET
30 x 60	12" x 24"	TODOS	6	24,00	1,08	11,62	48	51,84	558,00	1179,00
60 x 60	24" x 24"	TODOS	4	33,20	1,44	15,50	32	46,08	496,00	1089,40
45 x 90	18" x 36"	TODOS	2	20,50	0,81	8,72	39	31,59	340,03	826,50

# PÓRTLAND

PORCELÁNICO≈PORCELAIN TILE≈GRÉS CÉRAMÉ≈FEINSTEINZEUG

DESTONIFICACIÓN INTENCIONADA≈INTENTIONALLY NON-HOMOGENEOUS COLOUR≈  
DES VARIATIONS DE NUANCES INTENTIONNÉES≈DESIGNGEMÄßE ENTFÄRBUNG

## P41 GRIS

30x60 cm. (12x24") · MATE



### ACABADOS / FINISHES

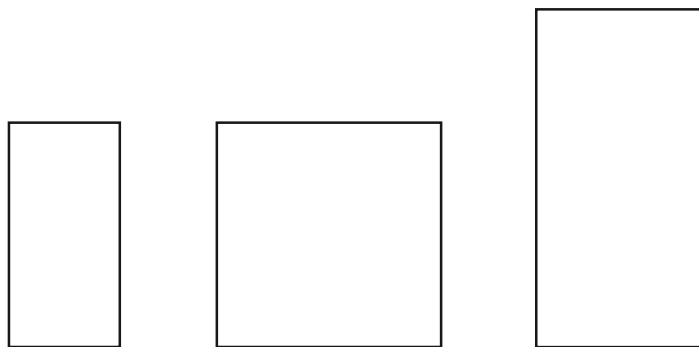

Mate B-44 Lucidato B-56 30 x 60 cm (12" x 24")	Mate B-54 Lucidato B-62 60 x 60 cm (24" x 24")	Mate B-58 Lucidato B-66 45 x 90 cm (18" x 36")
---	---	---

### PACKING LIST

PIEZAS BASE≈BASIC TILES≈ELÉMENTS DE BASE≈GRUNDFLIESEN

CM	SIZE	ACABADO/FINISH	PIEZAS CAJA/ PIECES BOX	KG CAJA	M² CAJA	SQFT BOX	CAJAS/BOXES EUROPALET	M² EUROPALET	SQFT EUROPALLET	KG EUROPALET
30 x 60	12" x 24"	TODOS	6	24,00	1,08	11,62	48	51,84	558,00	1179,00
60 x 60	24" x 24"	TODOS	4	33,20	1,44	15,50	32	46,08	496,00	1089,40
45 x 90	18" x 36"	TODOS	2	20,50	0,81	8,72	39	31,59	340,03	826,50

## P49 NEGRO

30x60 cm. (12x24") · MATE



### ACABADOS / FINISHES

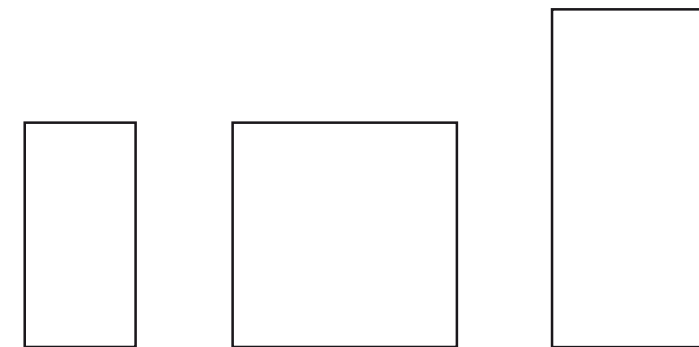

Mate B-44 Lucidato B-56 30 x 60 cm (12" x 24")	Mate B-54 Lucidato B-62 60 x 60 cm (24" x 24")	Mate B-58 Lucidato B-66 45 x 90 cm (18" x 36")
---	---	---

### PACKING LIST

PIEZAS BASE≈BASIC TILES≈ELÉMENTS DE BASE≈GRUNDFLIESEN

CM	SIZE	ACABADO/FINISH	PIEZAS CAJA/ PIECES BOX	KG CAJA	M² CAJA	SQFT BOX	CAJAS/BOXES EUROPALET	M² EUROPALET	SQFT EUROPALLET	KG EUROPALET
30 x 60	12" x 24"	TODOS	6	24,00	1,08	11,62	48	51,84	558,00	1179,00
60 x 60	24" x 24"	TODOS	4	33,20	1,44	15,50	32	46,08	496,00	1089,40
45 x 90	18" x 36"	TODOS	2	20,50	0,81	8,72	39	31,59	340,03	826,50

# PÓRTLAND

PORCELÁNICO≈PORCELAIN TILE≈GRÉS CÉRAMÉ≈FEINSTEINZEUG

DESTONIFICACIÓN INTENCIONADA≈INTENTIONALLY NON-HOMOGENEOUS COLOUR≈  
DES VARIATIONS DE NUANCES INTENTIONNÉES≈DESIGNEMÄÙE ENTFÄRBUNG

## PIEZAS COMPLEMENTARIAS≈ACCESSORIES≈ACCESSOIRES ET DECORATIONS≈FORMTEILE



MOSAICO 5,8x5,8  
PÓRTLAND MARRÓN  
MATE  
30 x 30 cm (12" x 12")  
P-12

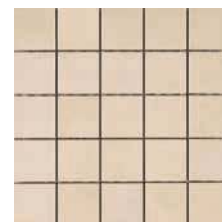

MOSAICO 5,8x5,8  
PÓRTLAND NACAR  
MATE  
30 x 30 cm (12" x 12")  
P-12



MOSAICO 5,8x5,8  
PÓRTLAND GRIS  
MATE  
30 x 30 cm (12" x 12")  
P-12



MOSAICO 5,8x5,8  
PÓRTLAND NEGRO  
MATE  
30 x 30 cm (12" x 12")  
P-12



MOSAICO 2,3x9,8  
PÓRTLAND MARRÓN  
LUCIDATO  
30 x 30 cm (12" x 12")  
P-16

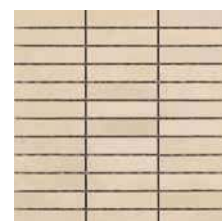

MOSAICO 2,3x9,8  
PÓRTLAND NACAR  
LUCIDATO  
30 x 30 cm (12" x 12")  
P-16



MOSAICO 2,3x9,8  
PÓRTLAND GRIS  
LUCIDATO  
30 x 30 cm (12" x 12")  
P-16



MOSAICO 2,3x9,8  
PÓRTLAND NEGRO  
LUCIDATO  
30 x 30 cm (12" x 12")  
P-16



MOSAICO MIX 2,3x9,8  
PÓRTLAND FRÍO  
LUCIDATO  
30 x 30 cm (12" x 12")  
P-16



MOSAICO BRICK  
PÓRTLAND NACAR  
LUCIDATO  
30 x 30 cm (12" x 12")  
P-20



MOSAICO BRICK  
PÓRTLAND GRIS  
LUCIDATO  
30 x 30 cm (12" x 12")  
P-20



MOSAICO BRICK  
PÓRTLAND NEGRO  
LUCIDATO  
30 x 30 cm (12" x 12")  
P-20

≈ Mosaico 5,8x5,8 Pórtland Marrón mate.



## PIEZAS COMPLEMENTARIAS≈ACCESSORIES≈ACCESSOIRES ET DECORATIONS≈FORMTEILE

### PACKING LIST

COMPLEMENTOS DECORATIVOS≈DECORATIVE ACCESSORIES≈COMPLÉMENTS DE DÉCORATION≈FORMTEILE

PIEZA/PIECE	CM	SIZE	ACABADO/ FINISH	PRECIO/ PRICE	PIEZA/PIECE	CM	SIZE	ACABADO/ FINISH	PRECIO/ PRICE
MOSAICO 5,8x5,8 PÓRTLAND MARRÓN	30x30	12" x 12"	MATE	P-12	MOSAICO 2,3x9,8 PÓRTLAND GRIS	30x30	12" x 12"	LUCIDATO	P-16
MOSAICO 5,8x5,8 PÓRTLAND NACAR	30x30	12" x 12"	MATE	P-12	MOSAICO 2,3x9,8 PÓRTLAND NEGRO	30x30	12" x 12"	LUCIDATO	P-16
MOSAICO 5,8x5,8 PÓRTLAND GRIS	30x30	12" x 12"	MATE	P-12	MOSAICO MIX 2,3x9,8 PÓRTLAND FRÍO	30x30	12" x 12"	LUCIDATO	P-16
MOSAICO 5,8x5,8 PÓRTLAND NEGRO	30x30	12" x 12"	MATE	P-12	MOSAICO BRICK PÓRTLAND NACAR	30x30	12" x 12"	LUCIDATO	P-20
MOSAICO 2,3x9,8 PÓRTLAND MARRÓN	30x30	12" x 12"	LUCIDATO	P-16	MOSAICO BRICK PÓRTLAND GRIS	30x30	12" x 12"	LUCIDATO	P-20
MOSAICO 2,3x9,8 PÓRTLAND NACAR	30x30	12" x 12"	LUCIDATO	P-16	MOSAICO BRICK PÓRTLAND NEGRO	30x30	12" x 12"	LUCIDATO	P-20

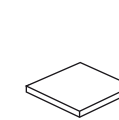

**Taco**  
Insert

8 x 8 cm (3,2" x 3,2")

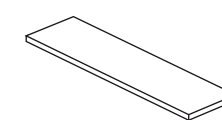

**Listel**  
Listel

8 x 30 cm (3,2" x 12")  
8 x 45 cm (3,2" x 18")  
8 x 60 cm (3,2" x 24")  
8 x 90 cm (3,2" x 36")

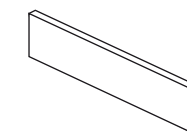

**Rodapié Cortado**  
Straight skirting

8 x 30 cm (3,2" x 12")  
8 x 45 cm (3,2" x 18")  
8 x 60 cm (3,2" x 24")  
8 x 90 cm (3,2" x 36")

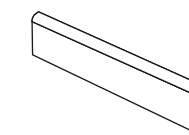

**Rodapié Canto Romo**  
Skirting bullnose

8 x 30 cm (3,2" x 12")  
8 x 45 cm (3,2" x 18")  
8 x 60 cm (3,2" x 24")  
8 x 90 cm (3,2" x 36")

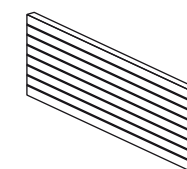

**Inciación**  
Incision

30 x 60 cm (12" x 24")

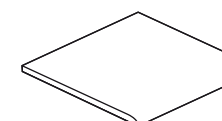

**Canto Romo**  
Rounded edge piece

30 x 60 cm (12" x 24")  
45 x 90 cm (18" x 36")  
60 x 60 cm (24" x 24")

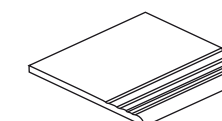

**Peldaño Ranurado**  
Grooved stair tread

30 x 60 cm (12" x 24")  
45 x 90 cm (18" x 36")  
60 x 60 cm (24" x 24")

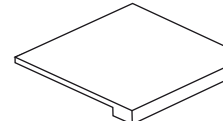

**Peldaño Elit con o sin ranura**  
Grooved Elit Stair/Plain Elit Stair

30 x 60 cm (12" x 24")  
45 x 90 cm (18" x 36")  
60 x 60 cm (24" x 24")

### PACKING LIST

PIEZAS ESPECIALES≈SPECIAL ACCESSORIES≈ÉLÉMENTS SPÉCIAUX≈SPEZIALTEILE

PIEZA/PIECE	CM	SIZE	ACABADO/ FINISH	PRECIO/ PRICE	PIEZA/PIECE	CM	SIZE	ACABADO/ FINISH	PRECIO/ PRICE
Taco - Insert	8x8	3,2" x 3,2"	TODOS	P-02	Canto Romo 2 lados - Rounded edge piece 2 sides	30x60	12" x 24"	TODOS	P-25
Rodapié Cortado - Straight skirting	8x30	3,2" x 12"	TODOS	P-02	Canto Romo 2 lados - Rounded edge piece 2 sides	45x90	18" x 36"	TODOS	P-49
Rodapié Cortado - Straight skirting	8x45	3,2" x 18"	TODOS	P-04	Canto Romo 2 lados - Rounded edge piece 2 sides	60x60	24" x 24"	TODOS	P-38
Rodapié Cortado - Straight skirting	8x60	3,2" x 24"	TODOS	P-05	Peldaño Ranurado - Grooved stair tread	30x60	12" x 24"	TODOS	P-18
Rodapié Cortado - Straight skirting	8x90	3,2" x 36"	TODOS	P-08	Peldaño Ranurado - Grooved stair tread	45x90	18" x 36"	TODOS	P-38
Rodapié Canto Romo - Skirting bullnose	8x30	3,2" x 12"	TODOS	P-03	Peldaño Ranurado - Grooved stair tread	60x60	24" x 24"	TODOS	P-31
Rodapié Canto Romo - Skirting bullnose	8x45	3,2" x 18"	TODOS	P-05	Peldaño Ranurado Esquina - Grooved stair tread corner	30x60	12" x 24"	TODOS	P-25
Rodapié Canto Romo - Skirting bullnose	8x60	3,2" x 24"	TODOS	P-06	Peldaño Ranurado Esquina - Grooved stair tread corner	45x90	18" x 36"	TODOS	P-49
Rodapié Canto Romo - Skirting bullnose	8x90	3,2" x 36"	TODOS	P-10	Peldaño Ranurado Esquina - Grooved stair tread corner	60x60	24" x 24"	TODOS	P-38
Listel	8x30	3,2" x 12"	TODOS	P-02	Peldaño Elit (lado 30) - Elit step (12" side)	30x60	12" x 24"	TODOS	P-30
Listel	8x45	3,2" x 18"	TODOS	P-04	Peldaño Elit (lado 60) - Elit step (24" side)	30x60	12" x 24"	TODOS	P-48
Listel	8x60	3,2" x 24"	TODOS	P-05	Peldaño Elit (lado 45) - Elit step (18" side)	45x90	18" x 36"	TODOS	P-57
Listel	8x90	3,2" x 36"	TODOS	P-08	Peldaño Elit (lado 90) - Elit step (36" side)	45x90	18" x 36"	TODOS	P-84
Inciación	30x60	12" x 24"	TODOS	P-14	Peldaño Elit - Elit step	60x60	24" x 24"	TODOS	P-62
Canto Romo 1 lado - Rounded edge piece 1 side	30x60	12" x 24"	TODOS	P-18	Peldaño Elit Esquina - Elit step corner	30x60	12" x 24"	TODOS	P-69
Canto Romo 1 lado - Rounded edge piece 1 side	45x90	18" x 36"	TODOS	P-38	Peldaño Elit Esquina - Elit step corner	45x90	18" x 36"	TODOS	P-118
Canto Romo 1 lado - Rounded edge piece 1 side	60x60	24" x 24"	TODOS	P-31	Peldaño Elit Esquina - Elit step corner	60x60	24" x 24"	TODOS	P-104

Estas piezas se venden por unidad, a excepción de los rodapiés que se venden en cajas de 10 uds.  
These items are sold by pieces with the exception of the skirtings which are sold by boxes of 10 pieces each.  
Unité de vente à la pièce, sauf les plinthes vendus à la boîte de 10 unités.  
Die Formteile sind pro Stück verkauft außer die Sockel, die pro Karton mit 10 Stück verkauft sind.



≈ Quantum Gris 60x60 mate.



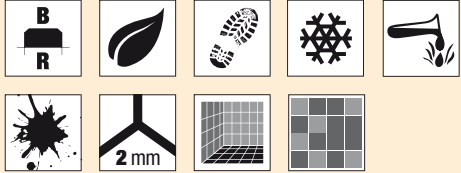
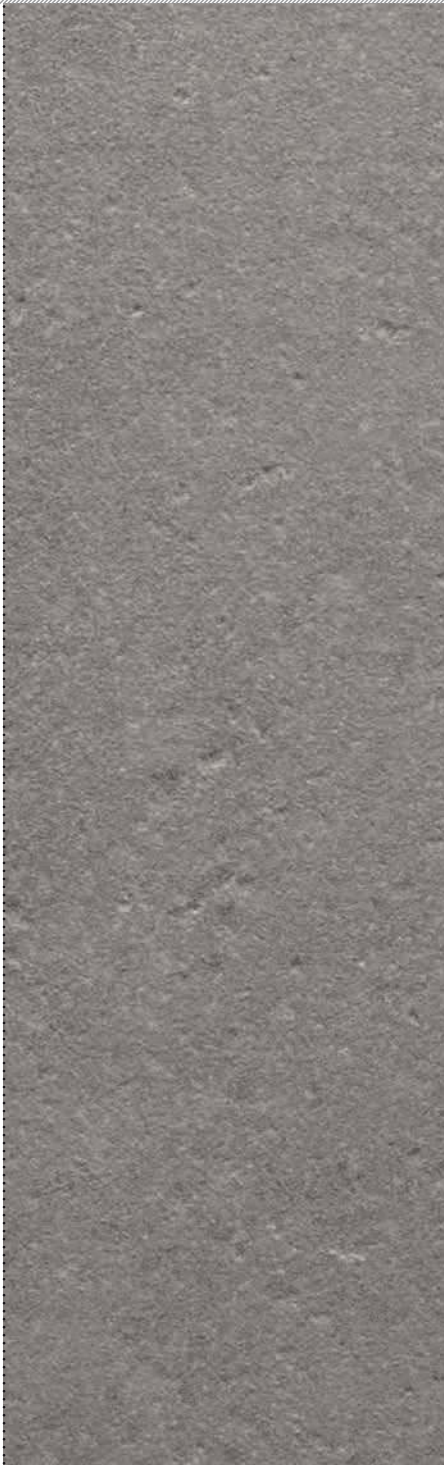

# QUANTUM

PORCELÁNICO≈PORCELAIN TILE≈GRÉS CÉRAME≈FEINSTEINZEUG

CARACTERÍSTICAS TÉCNICAS TECHNICAL CHARACTERISTICS	MODELOS MODELS	≡ MATE ≡	≡ LUCIDATO ≡	≡ RÚSTICO ≡
	<p><b>FORMATOS≈SIZES</b></p> <p>30 x 60 cm (12" x 24") 60 x 60 cm (24" x 24") 60 x 60 cm (24" x 24") Esp.</p>  <p>Consulte página 10≈See page 10≈ Voir page 10≈Sehen Sie Seite 10</p> <p><b>ÁMBITOS DE USO≈AREA OF USE</b></p> <p><b>MATE / LUCIDATO</b> Idóneo para zonas interiores secas. <i>Suitable for dry indoor areas.</i> <i>Idéal pour application intérieure sèche.</i> <i>Ideal für trockene Innenräume.</i></p> <p><b>RÚSTICO</b> Idóneo para interiores húmedos, exteriores y piscinas. <i>Suitable for wet indoor areas, outdoor areas and swimming pools.</i> <i>Idéal pour application intérieure humide et pour extérieurs et piscines.</i> <i>Ideal für Nassbereiche, innen sowie außen und in Schwimmbädern.</i></p> <p><b>ANTI - SLIP</b> 45°</p> <p><b>NORMA≈NORM</b></p> <p>NORMA UNE-ENV 12633:2003</p> <ul style="list-style-type: none"> <li>- Quantum Mate: Clase 1</li> <li>- Quantum Lucidato: Clase 1</li> <li>- Quantum Rústico: Clase 3</li> </ul> <p>NORMA DIN 51130</p> <ul style="list-style-type: none"> <li>- Quantum Rústico: R - 12</li> </ul> <p>NORMA DIN 51097 (Pie descalzo)</p> <ul style="list-style-type: none"> <li>- Quantum Rústico: Grupo C</li> </ul>	<p>≡ GRAFITO</p> <p>≡ GRIS</p> <p>≡ BEIGE</p>		

Detalle a escala 1:1 ≈ Detail scale 1:1 ≈ Detail échelle 1:1 ≈ Maßstab 1:1

	MATE	LUCIDATO	RÚSTICO
BEIGE	●	●	●
GRIS	●	●	●
GRAFITO	●	●	●

# QUANTUM

PORCELÁNICO~PORCELAIN TILE~GRÉS CÉRAME~FEINSTEINZEUG

≈ Quantum Gris 60x60 Esp. Rústico.



# QUANTUM

PORCELÁNICO~PORCELAIN TILE~GRÉS CÉRAME~FEINSTEINZEUG

≈ Quantum Grafito 60x60 lucidato.



# QUANTUM

PORCELÁNICO~PORCELAIN TILE~GRÉS CÉRAME~FEINSTEINZEUG

≡ Quantum Grafito 60x60 lucidato.

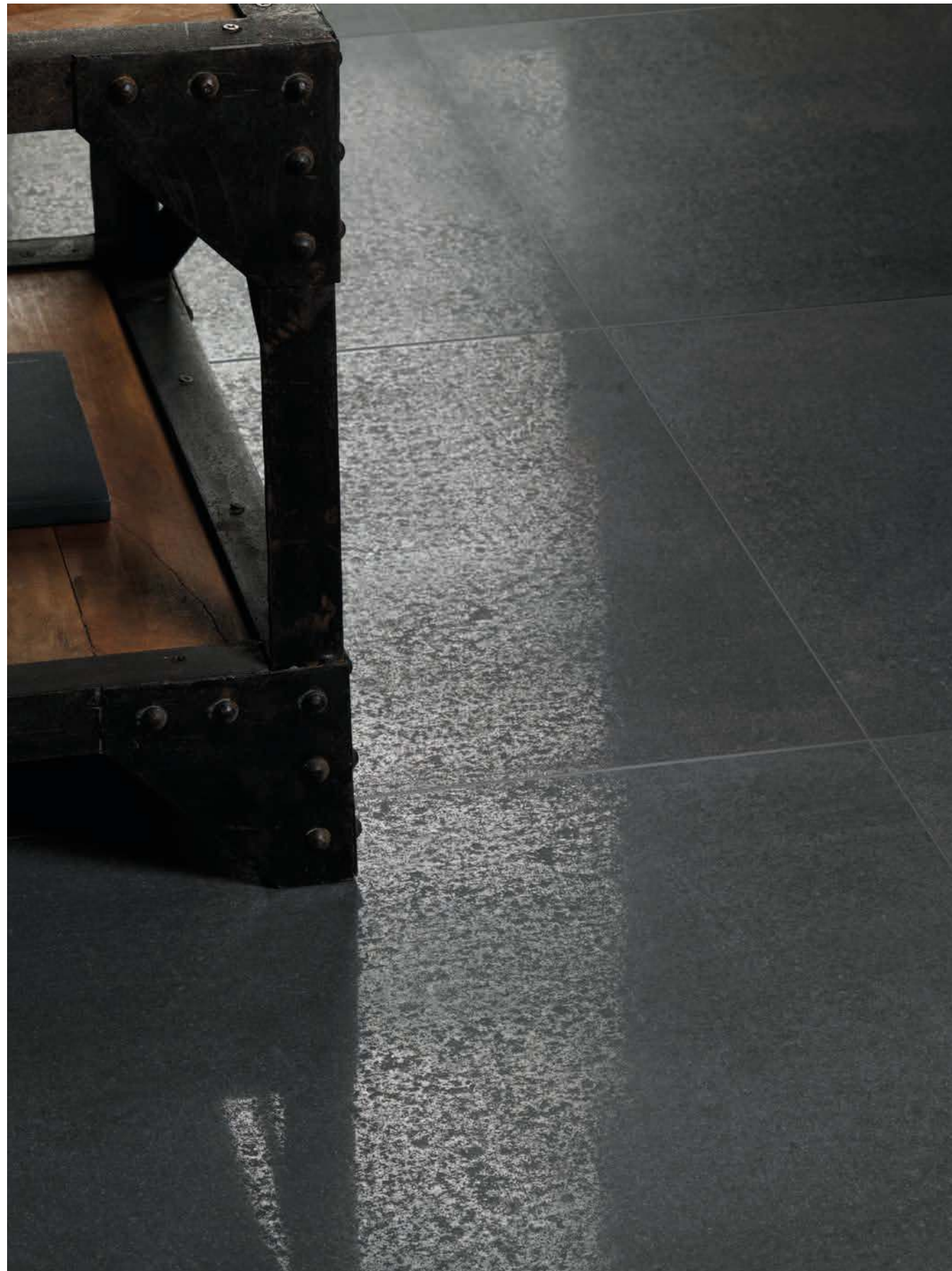

≡ Quantum Grafito 60x60 mate.



# QUANTUM

PORCELÁNICO~PORCELAIN TILE~GRÉS CÉRAME~FEINSTEINZEUG

≈ Quantum Gris 60x60 Esp. Rústico.



≈ Quantum Gris 60x60 Esp. rústico + Quantum Gris 60x60 mate.

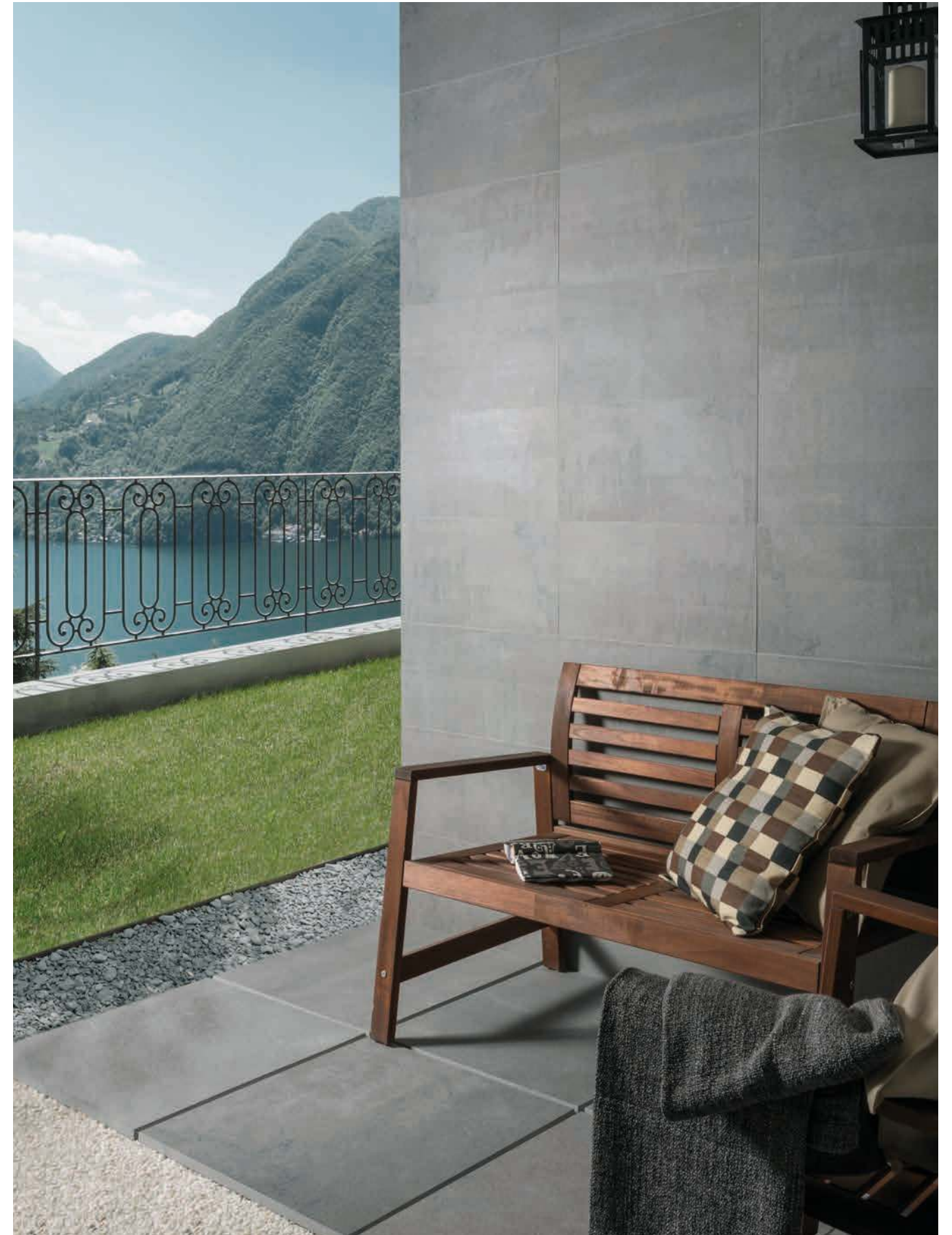

# QUANTUM

PORCELÁNICO≈PORCELAIN TILE≈GRÉS CÉRAME≈FEINSTEINZEUG

## Q24 GRAFITO ≡

30x60 cm. (12x24") · MATE



ACABADOS / FINISHES

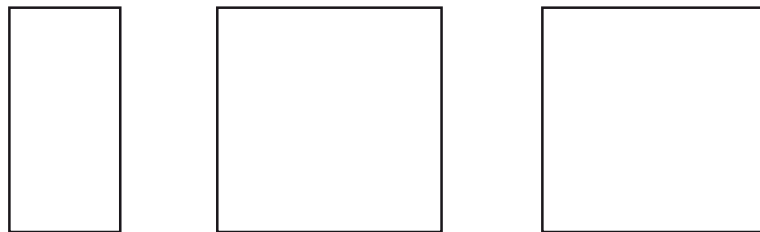

Mate B-49 Lucidato B-56 Rústico B-49 30 x 60 cm (12" x 24")	Mate B-55 Lucidato B-62 Rústico B-55 60 x 60 cm (24" x 24")	Esp. Rústico B-109 60 x 60 cm (24" x 24")
---	---	---

### PACKING LIST

PIEZAS BASE≈BASIC TILES≈ELÉMENTS DE BASE≈GRUNDFLIESEN

CM	SIZE	ACABADO/FINISH	PIEZAS CAJA/ PIECES BOX	KG CAJA	M² CAJA	SQFT BOX	CAJAS/BOXES EUROPALET	M² EUROPALET	SQFT EUROPALLET	KG EUROPALET
30 x 60	12" x 24"	TODOS	6	24,00	1,08	11,62	48	51,84	558,00	1179,00
60 x 60	24" x 24"	TODOS	4	33,20	1,44	15,50	32	46,08	496,00	1089,40
60 x 60	24" x 24"	ESP RÚSTICO	2	34,00	0,720	7,75	30	21,60	232,50	1.047,00

## Q21 GRIS ≡

Reciclado

30x60 cm. (12x24") · MATE



ACABADOS / FINISHES

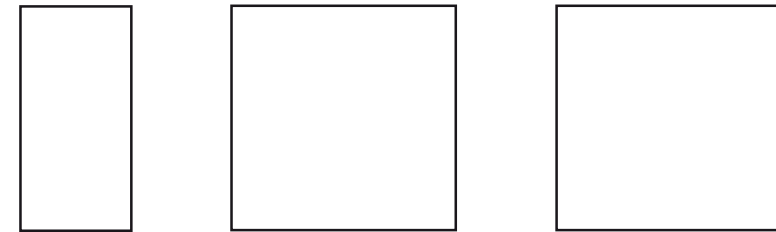

Mate B-49 Lucidato B-56 Rústico B-49 30 x 60 cm (12" x 24")	Mate B-55 Lucidato B-62 Rústico B-55 60 x 60 cm (24" x 24")	Esp. Rústico B-109 60 x 60 cm (24" x 24")
---	---	---

### PACKING LIST

PIEZAS BASE≈BASIC TILES≈ELÉMENTS DE BASE≈GRUNDFLIESEN

CM	SIZE	ACABADO/FINISH	PIEZAS CAJA/ PIECES BOX	KG CAJA	M² CAJA	SQFT BOX	CAJAS/BOXES EUROPALET	M² EUROPALET	SQFT EUROPALLET	KG EUROPALET
30 x 60	12" x 24"	RÚSTICO	6	24,00	1,08	11,62	48	51,84	558,00	1179,00
60 x 60	24" x 24"	TODOS	4	33,20	1,44	15,50	32	46,08	496,00	1089,40
60 x 60	24" x 24"	ESP RÚSTICO	2	34,00	0,720	7,75	30	21,60	232,50	1.047,00

# QUANTUM

PORCELÁNICO≈PORCELAIN TILE≈GRÉS CÉRAME≈FEINSTEINZEUG

## Q22 BEIGE ≈

30x60 cm. (12x24") · MATE



### ACABADOS / FINISHES

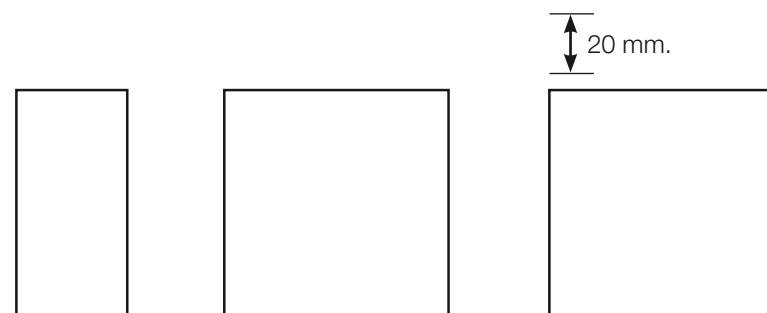

Mate B-49  
Lucidato B-56  
Rústico B-49  
30 x 60 cm  
(12" x 24")

Mate B-55  
Lucidato B-62  
Rústico B-55  
60 x 60 cm  
(24" x 24")

Esp. Rústico B-109  
60 x 60 cm  
(24" x 24")

### PACKING LIST

PIEZAS BASE≈BASIC TILES≈ELÉMENTS DE BASE≈GRUNDFLIESEN

CM	SIZE	ACABADO/FINISH	PIEZAS CAJA/ PIECES BOX	KG CAJA	M² CAJA	SQFT BOX	CAJAS/BOXES EUROPALET	M² EUROPALET	SQFT EUROPALLET	KG EUROPALET
30 x 60	12" x 24"	TODOS	6	24,00	1,08	11,62	48	51,84	558,00	1179,00
60 x 60	24" x 24"	TODOS	4	33,20	1,44	15,50	32	46,08	496,00	1089,40
60 x 60	24" x 24"	ESP RÚSTICO	2	34,00	0,720	7,75	30	21,60	232,50	1.047,00

## PIEZAS COMPLEMENTARIAS≈ACCESSORIES≈ACCESSOIRES ET DECORATIONS≈FORMTEILE

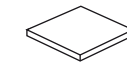

**Taco**  
*Insert*  
8 x 8 cm (3,2" x 3,2")

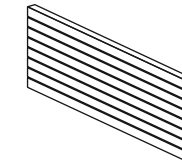

**Incisión**  
*Incision*  
30 x 60 cm (12" x 24")

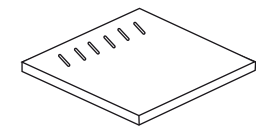

**Rejilla 20 mm.**  
*Grating 20 mm.*  
60 x 60 cm (24" x 24")

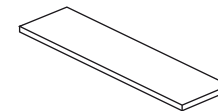

**Listel**  
*Listel*  
8 x 30 cm (3,2" x 12")  
8 x 60 cm (3,2" x 24")

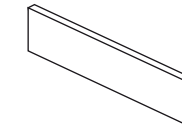

**Rodapié Cortado**  
*Straight skirting*  
8 x 30 cm (3,2" x 12")  
8 x 60 cm (3,2" x 24")

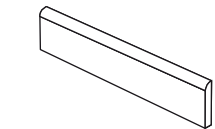

**Rodapié Canto Romo**  
*Skirting bullnose*  
8 x 30 cm (3,2" x 12")  
8 x 60 cm (3,2" x 24")

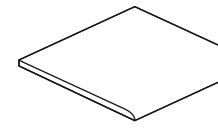

**Canto Romo**  
*Rounded edge piece*  
30 x 60 cm (12" x 24")  
60 x 60 cm (24" x 24")

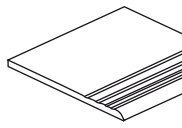

**Peldaño Ranurado**  
*Grooved stair tread*  
30 x 60 cm (12" x 24")  
60 x 60 cm (24" x 24")

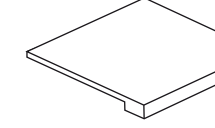

**Peldaño Elit con o sin ranura**  
*Grooved Elit Stair/Plain Elit Stair*  
30 x 60 cm (12" x 24")  
60 x 60 cm (24" x 24")

### PACKING LIST

PIEZAS ESPECIALES≈SPECIAL ACCESSORIES≈ELÉMENTS SPÉCIAUX≈SPEZIALTEILE

PIEZA/PIECE	CM	SIZE	ACABADO/ FINISH	PRECIO/ PRICE	PIEZA/PIECE	CM	SIZE	ACABADO/ FINISH	PRECIO/ PRICE
Taco - Insert	8x8	3,2" x 3,2"	TODOS	P-02	Canto Romo 2 lados - Rounded edge piece 2 sides	60x60	24" x 24"	TODOS	P-35
Rodapié Cortado - Straight skirting	8x30	3,2" x 12"	TODOS	P-02	Peldaño Ranurado - Grooved stair tread	30x60	12" x 24"	TODOS	P-17
Rodapié Cortado - Straight skirting	8x60	3,2" x 24"	TODOS	P-05	Peldaño Ranurado - Grooved stair tread	60x60	24" x 24"	TODOS	P-28
Rodapié Canto Romo - Skirting bullnose	8x30	3,2" x 12"	TODOS	P-03	Peldaño Ranurado Esquina - Grooved stair tread corner	30x60	12" x 24"	TODOS	P-23
Rodapié Canto Romo - Skirting bullnose	8x60	3,2" x 24"	TODOS	P-06	Peldaño Ranurado Esquina - Grooved stair tread corner	60x60	24" x 24"	TODOS	P-35
Listel	8x30	3,2" x 12"	TODOS	P-02	Peldaño Elit (lado 30) - Elit step (12" side)	30x60	12" x 24"	TODOS	P-29
Listel	8x60	3,2" x 24"	TODOS	P-05	Peldaño Elit (lado 60) - Elit step (24" side)	30x60	12" x 24"	TODOS	P-47
Incisión	30x60	12" x 24"	TODOS	P-13	Peldaño Elit - Elit step	60x60	24" x 24"	TODOS	P-59
Canto Romo 1 lado - Rounded edge piece 1 side	30x60	12" x 24"	TODOS	P-17	Peldaño Elit Esquina - Elit step corner	30x60	12" x 24"	TODOS	P-67
Canto Romo 1 lado - Rounded edge piece 1 side	60x60	24" x 24"	TODOS	P-28	Peldaño Elit Esquina - Elit step corner	60x60	24" x 24"	TODOS	P-100
Canto Romo 2 lados - Rounded edge piece 2 sides	30x60	12" x 24"	TODOS	P-23					

### ESPESORADO

Taco - Insert	8x8	3,2" x 3,2"	RÚSTICO	P-02	Peldaño Ranurado - Grooved stair tread	60x60	24" x 24"	RÚSTICO	P-40
Rodapié Cortado - Straight skirting	8x60	3,2" x 24"	RÚSTICO	P-06	Peldaño Ranurado Esquina - Grooved stair tread corner	60x60	24" x 24"	RÚSTICO	P-47
Rodapié Canto Romo - Skirting bullnose	8x60	3,2" x 24"	RÚSTICO	P-09	Peldaño Elit - Elit step	60x60	24" x 24"	RÚSTICO	P-85
Listel	8x60	3,2" x 24"	RÚSTICO	P-06	Peldaño Elit Esquina - Elit step corner	60x60	24" x 24"	RÚSTICO	P-132
Canto Romo 1 lado - Rounded edge piece 1 side	60x60	24" x 24"	RÚSTICO	P-40	Rejilla - Grating	60x60	24" x 24"	RÚSTICO	P-63
Canto Romo 2 lados - Rounded edge piece 2 sides	60x60	24" x 24"	RÚSTICO	P-47					

Estas piezas se venden por unidad, a excepción de los rodapiés que se venden en cajas de 10 uds. (espesorado: 5 uds/caja).  
These items are sold by pieces with the exception of the skirtings which are sold by boxes of 10 pieces each (special thickness 5 pcs/box).  
Unité de vente à la pièce, sauf les plinthes vendus à la boîte de 10 unités (É paisseurs 5 pièce/boîte).  
Die Formteile sind pro Stück verkauft außer die Sockel, die pro Karton mit 10 Stück verkauft sind (Spezialdicke 5 Stück pro Karton).

≈ Quarcity Gris 60x60 rústico.





## CARACTERÍSTICAS TÉCNICAS TECHNICAL CHARACTERISTICS

### FORMATOS≈SIZES

30 x 60 cm (12" x 24")  
60 x 60 cm (24" x 24")  
60 x 60 cm (24" x 24") Esp.

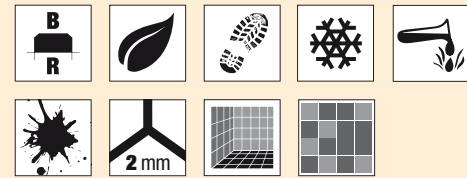

Consulte página 10≈See page 10≈  
Voir page 10≈Sehen Sie Seite 10

### ÁMBITOS DE USO≈AREA OF USE

#### LUCIDATO

Idóneo para zonas interiores secas.  
*Suitable for dry indoor areas.*  
*Idéal pour application intérieure sèche.*  
*Ideal für trockene Innenräume.*



#### RÚSTICO

Idóneo para interiores húmedos,  
exteriores y piscinas.  
*Suitable for wet indoor areas, outdoor  
areas and swimming pools.*  
*Idéal pour application intérieure humide  
et pour extérieurs et piscines.*  
*Ideal für Nassbereiche, innen sowie  
außen und in Schwimmbädern.*

### NORMA≈NORM

NORMA UNE-ENV 12633:2003

- Quarcity Lucidato: Clase 1
- Quarcity Rústico: Clase 3

NORMA DIN 51130

- Quarcity Rústico: R-12

NORMA DIN 51097 (Pie descalzo)

- Quarcity Rústico: Grupo C

## MODELOS MODELS

≈  
BEIGE

≈  
GRIS

≈  
GRAFITO

≈  
NEGRO

≈ LUCIDATO ≈

≈ RÚSTICO ≈

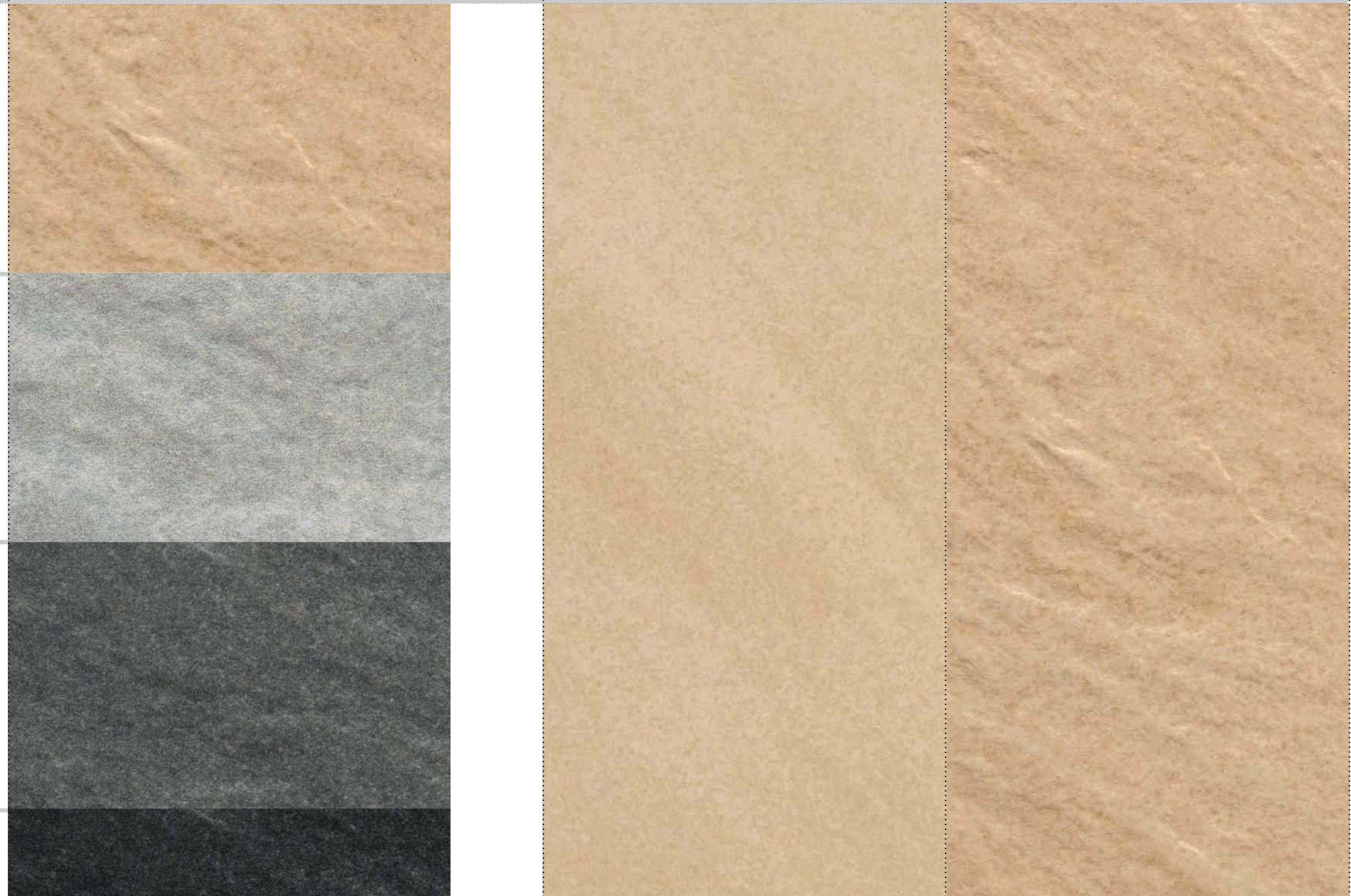

Detalle a escala 1:1 ≈ Detail scale 1:1 ≈ Detail échelle 1:1 ≈ Maßstab 1:1

	LUCIDATO	RÚSTICO
BEIGE	●	●
GRIS	●	●
GRAFITO	●	●
NEGRO	●	●

# QUARCITY

PORCELÁNICO~PORCELAIN TILE~GRÉS CÉRAME~FEINSTEINZEUG

∞ Quarcity Beige 60x60 Esp. rústico.



# QUARCITY

PORCELÁNICO~PORCELAIN TILE~GRÉS CÉRAME~FEINSTEINZEUG

≈ Quarcity Negro 60x60 Esp. rústico.



≈ Quarcity Grafito 60x60 Esp. rústico.

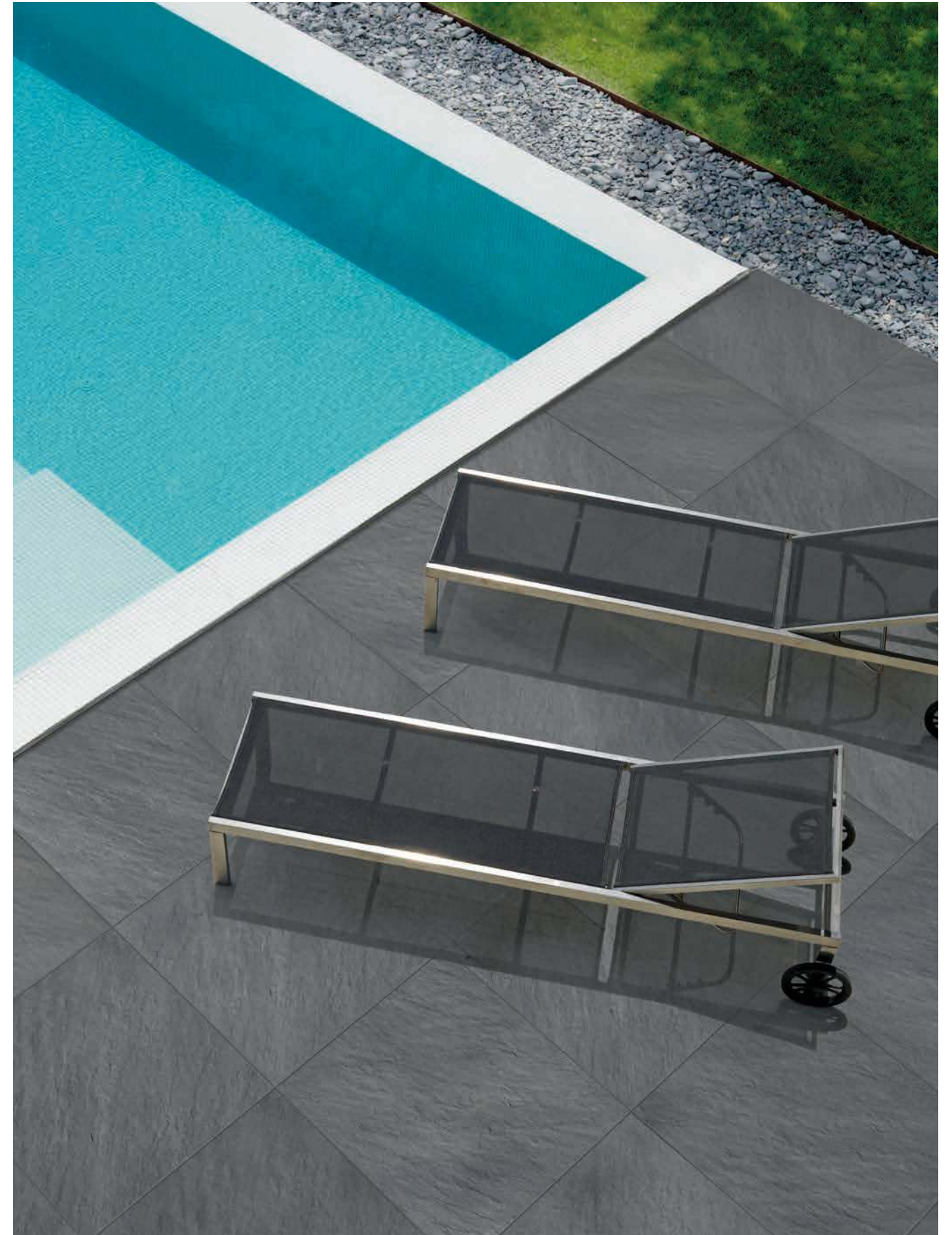

# QUARCITY

PORCELÁNICO~PORCELAIN TILE~GRÉS CÉRAME~FEINSTEINZEUG

≈ Quarcity Beige 60x60 lucidato.



# QUARCITY

PORCELÁNICO≈PORCELAIN TILE≈GRÉS CÉRAME≈FEINSTEINZEUG

DESTONIFICACIÓN INTENCIONADA≈INTENTIONALLY NON-HOMOGENEOUS COLOUR≈  
DES VARIATIONS DE NUANCES INTENTIONNÉES≈DESIGNGEMÄÙE ENTFÄRBUNG

## Q02 BEIGE

30x60 cm. (12x24") · RÚSTICO



ACABADOS / FINISHES

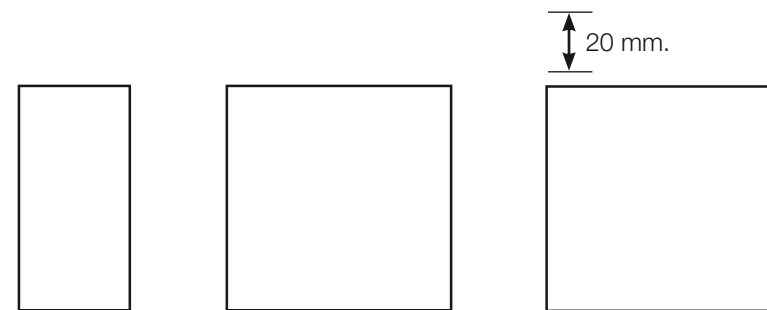

Rústico B-36  
30 x 60 cm  
(12" x 24")

Lucidato B-53  
Rústico B-43  
60 x 60 cm  
(24" x 24")

Esp Rústico B-105  
60 x 60 cm  
(24" x 24")

### PACKING LIST

PIEZAS BASE≈BASIC TILES≈ELÉMENTS DE BASE≈GRUNDFLIESEN

CM	SIZE	ACABADO/FINISH	PIEZAS CAJA/ PIECES BOX	KG CAJA	M² CAJA	SQFT BOX	CAJAS/BOXES EUROPALET	M² EUROPALET	SQFT EUROPALLET	KG EUROPALET
30 x 60	12" x 24"	RÚSTICO	6	24,00	1,08	11,62	48	51,84	558,00	1179,00
60 x 60	24" x 24"	TODOS	4	33,20	1,44	15,50	32	46,08	496,00	1089,40
60 x 60	24" x 24"	ESP RÚSTICO	2	34,00	0,720	7,75	30	21,60	232,50	1.047,00

## Q01 GRIS

30x60 cm. (12x24") · RÚSTICO



ACABADOS / FINISHES

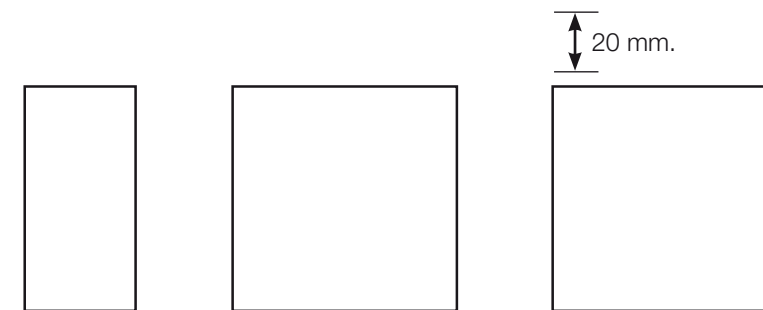

Rústico B-36  
30 x 60 cm  
(12" x 24")

Lucidato B-53  
Rústico B-43  
60 x 60 cm  
(24" x 24")

Esp Rústico B-105  
60 x 60 cm  
(24" x 24")

### PACKING LIST

PIEZAS BASE≈BASIC TILES≈ELÉMENTS DE BASE≈GRUNDFLIESEN

CM	SIZE	ACABADO/FINISH	PIEZAS CAJA/ PIECES BOX	KG CAJA	M² CAJA	SQFT BOX	CAJAS/BOXES EUROPALET	M² EUROPALET	SQFT EUROPALLET	KG EUROPALET
30 x 60	12" x 24"	RÚSTICO	6	24,00	1,08	11,62	48	51,84	558,00	1179,00
60 x 60	24" x 24"	TODOS	4	33,20	1,44	15,50	32	46,08	496,00	1089,40
60 x 60	24" x 24"	ESP RÚSTICO	2	34,00	0,720	7,75	30	21,60	232,50	1.047,00

## Q04 GRAFITO ≡

30x60 cm. (12x24") · RÚSTICO



### ACABADOS / FINISHES

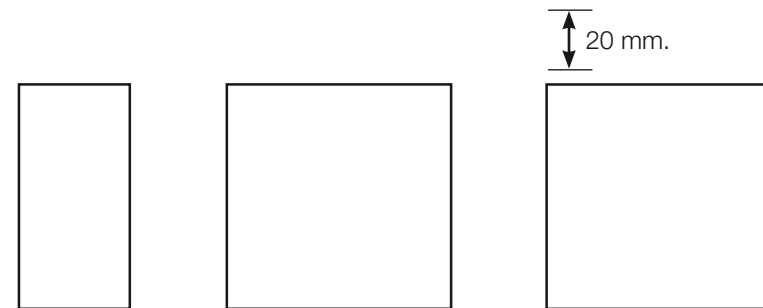

Rústico B-40  
30 x 60 cm  
(12" x 24")

Lucidato B-61  
Rústico B-51  
60 x 60 cm  
(24" x 24")

Esp Rústico B-105  
60 x 60 cm  
(24" x 24")

### PACKING LIST

PIEZAS BASE≈BASIC TILES≈ELÉMENTS DE BASE≈GRUNDFLIESEN

CM	SIZE	ACABADO/FINISH	PIEZAS CAJA/ PIECES BOX	KG CAJA	M² CAJA	SQFT BOX	CAJAS/BOXES EUROPALET	M² EUROPALET	SQFT EUROPALLET	KG EUROPALET
30 x 60	12" x 24"	RÚSTICO	6	24,00	1,08	11,62	48	51,84	558,00	1179,00
60 x 60	24" x 24"	TODOS	4	33,20	1,44	15,50	32	46,08	496,00	1089,40
60 x 60	24" x 24"	ESP RÚSTICO	2	34,00	0,720	7,75	30	21,60	232,50	1.047,00

## Q09 NEGRO ≡

30x60 cm. (12x24") · RÚSTICO



### ACABADOS / FINISHES

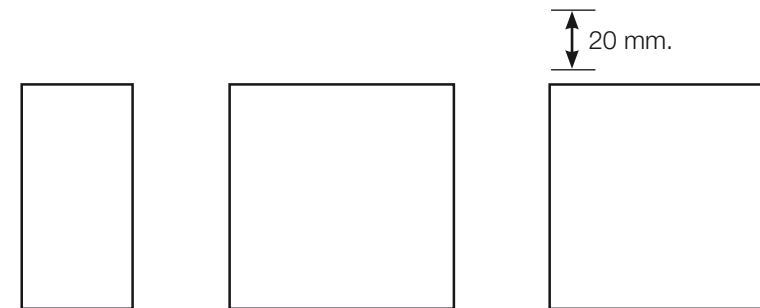
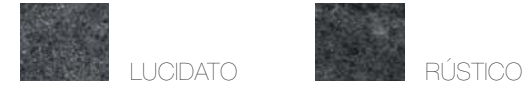

Rústico B-40  
30 x 60 cm  
(12" x 24")

Lucidato B-61  
Rústico B-51  
60 x 60 cm  
(24" x 24")

Esp Rústico B-105  
60 x 60 cm  
(24" x 24")

### PACKING LIST

PIEZAS BASE≈BASIC TILES≈ELÉMENTS DE BASE≈GRUNDFLIESEN

CM	SIZE	ACABADO/FINISH	PIEZAS CAJA/ PIECES BOX	KG CAJA	M² CAJA	SQFT BOX	CAJAS/BOXES EUROPALET	M² EUROPALET	SQFT EUROPALLET	KG EUROPALET
30 x 60	12" x 24"	RÚSTICO	6	24,00	1,08	11,62	48	51,84	558,00	1179,00
60 x 60	24" x 24"	TODOS	4	33,20	1,44	15,50	32	46,08	496,00	1089,40
60 x 60	24" x 24"	ESP RÚSTICO	2	34,00	0,720	7,75	30	21,60	232,50	1.047,00

≈ Quarcity Negro 60x60 Lucidato.



## PIEZAS COMPLEMENTARIAS≈ACCESSORIES≈ACCESSOIRES ET DECORATIONS≈FORMTEILE

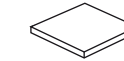

**Taco**  
*Insert*  
8 x 8 cm (3,2" x 3,2")

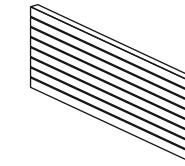

**Incisión**  
*Incision*  
30 x 60 cm (12" x 24")

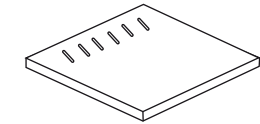

**Rejilla 20 mm.**  
*Grating 20 mm.*  
60 x 60 cm (24" x 24")

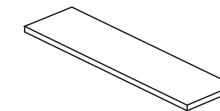

**Listel**  
*Listel*  
8 x 30 cm (3,2" x 12")  
8 x 60 cm (3,2" x 24")

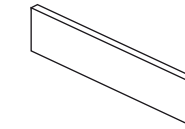

**Rodapié Cortado**  
*Straight skirting*  
8 x 30 cm (3,2" x 12")  
8 x 60 cm (3,2" x 24")

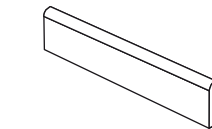

**Rodapié Canto Romo**  
*Skirting bullnose*  
8 x 30 cm (3,2" x 12")  
8 x 60 cm (3,2" x 24")

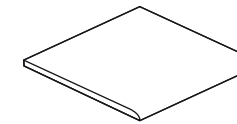

**Canto Romo**  
*Rounded edge piece*  
30 x 60 cm (12" x 24")  
60 x 60 cm (24" x 24")

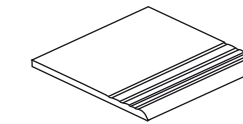

**Peldaño Ranurado**  
*Grooved stair tread*  
30 x 60 cm (12" x 24")  
60 x 60 cm (24" x 24")

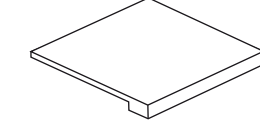

**Peldaño Elit con o sin ranura**  
*Grooved Elit Stair/Plain Elit Stair*  
30 x 60 cm (12" x 24")  
60 x 60 cm (24" x 24")

### PACKING LIST

PIEZAS ESPECIALES≈SPECIAL ACCESSORIES≈ELÉMENTS SPÉCIAUX≈SPEZIALTEILE

PIEZA/PIECE	CM	SIZE	ACABADO/ FINISH	PRECIO/ PRICE	PIEZA/PIECE	CM	SIZE	ACABADO/ FINISH	PRECIO/ PRICE
Taco - Insert	8x8	3,2" x 3,2"	RÚSTICO	P-02	Canto Romo 2 lados - Rounded edge piece 2 sides	60x60	24" x 24"	TODOS	P-35
Rodapié Cortado - Straight skirting	8x30	3,2" x 12"	RÚSTICO	P-02	Peldaño Ranurado - Grooved stair tread	30x60	12" x 24"	RÚSTICO	P-17
Rodapié Cortado - Straight skirting	8x60	3,2" x 24"	TODOS	P-05	Peldaño Ranurado - Grooved stair tread	60x60	24" x 24"	TODOS	P-28
Rodapié Canto Romo - Skirting bullnose	8x30	3,2" x 12"	RÚSTICO	P-03	Peldaño Ranurado Esquina - Grooved stair tread corner	30x60	12" x 24"	RÚSTICO	P-23
Rodapié Canto Romo - Skirting bullnose	8x60	3,2" x 24"	TODOS	P-06	Peldaño Ranurado Esquina - Grooved stair tread corner	60x60	24" x 24"	TODOS	P-35
Listel	8x30	3,2" x 12"	RÚSTICO	P-02	Peldaño Elit (lado 30) - Elit step (12" side)	30x60	12" x 24"	RÚSTICO	P-29
Listel	8x60	3,2" x 24"	TODOS	P-05	Peldaño Elit (lado 60) - Elit step (24" side)	30x60	12" x 24"	RÚSTICO	P-47
Incisión	30x60	12" x 24"	RÚSTICO	P-13	Peldaño Elit - Elit step	60x60	24" x 24"	TODOS	P-59
Canto Romo 1 lado - Rounded edge piece 1 side	30x60	12" x 24"	RÚSTICO	P-17	Peldaño Elit Esquina - Elit step corner	30x60	12" x 24"	RÚSTICO	P-67
Canto Romo 1 lado - Rounded edge piece 1 side	60x60	24" x 24"	TODOS	P-28	Peldaño Elit Esquina - Elit step corner	60x60	24" x 24"	TODOS	P-100
Canto Romo 2 lados - Rounded edge piece 2 sides	30x60	12" x 24"	RÚSTICO	P-23					

### ESPESORADO

Taco - Insert	8x8	3,2" x 3,2"	RÚSTICO	P-02	Peldaño Ranurado - Grooved stair tread	60x60	24" x 24"	RÚSTICO	P-40
Rodapié Cortado - Straight skirting	8x60	3,2" x 24"	RÚSTICO	P-06	Peldaño Ranurado Esquina - Grooved stair tread corner	60x60	24" x 24"	RÚSTICO	P-47
Rodapié Canto Romo - Skirting bullnose	8x60	3,2" x 24"	RÚSTICO	P-09	Peldaño Elit - Elit step	60x60	24" x 24"	RÚSTICO	P-85
Listel	8x60	3,2" x 24"	RÚSTICO	P-06	Peldaño Elit Esquina - Elit step corner	60x60	24" x 24"	RÚSTICO	P-132
Canto Romo 1 lado - Rounded edge piece 1 side	60x60	24" x 24"	RÚSTICO	P-40	Rejilla - Grating	60x60	24" x 24"	RÚSTICO	P-63
Canto Romo 2 lados - Rounded edge piece 2 sides	60x60	24" x 24"	RÚSTICO	P-47					

Estas piezas se venden por unidad, a excepción de los rodapiés que se venden en cajas de 10 uds. (espesorado: 5 uds/caja).  
These items are sold by pieces with the exception of the skirtings which are sold by boxes of 10 pieces each (special thickness 5 pcs/box).  
Unité de vente à la pièce, sauf les plinthes vendus à la boîte de 10 unités (É paisseurs 5 pièce/boîte).  
Die Formteile sind pro Stück verkauft außer die Sockel, die pro Karton mit 10 Stück verkauft sind (Spezialdicke 5 Stück pro Karton).





≈ Roma Arena 30x60 mate.









**CARACTERÍSTICAS TÉCNICAS**  
TECHNICAL CHARACTERISTICS

**FORMATOS~SIZES**  
30 x 60 cm (12" x 24")  
45 x 90 cm (18" x 36")  
60 x 60 cm (24" x 24")

Consulte página 10~See page 10~  
Voir page 10~Sehen Sie Seite 10

**ÁMBITOS DE USO~AREA OF USE**

**MATE**  
Idóneo para zonas interiores secas.  
*Suitable for dry indoor areas.*  
*Idéal pour application intérieure sèche.*  
*Ideal für trockene Innenräume.*

**ANTI - SLIP**  
45°

**ANTIDESLIZANTE**  
Recomendado para interiores húmedos, exteriores y piscinas.  
*Suitable for wet indoor areas, outdoor areas and swimming pools.*  
*Idéal pour application intérieure humide et pour extérieurs et piscines.*  
*Ideal für Nassbereiche, innen sowie außen und in Schwimmbädern.*

**NORMA~NORM**

NORMA UNE-ENV 12633:2003  
- Roma Mate: Clase 1  
- Roma Antideslizante: Clase 3

NORMA DIN 51130  
- Roma Mate: R - 9  
- Roma Antideslizante: R - 10

NORMA DIN 51097 (Pie descalzo)  
- Roma Antideslizante: Grupo C

**MODELOS MODELS**

≡  
NEGRO

≡  
GRAFITO

≡  
GRIS

≡  
NACAR

≡  
ARENA

≡ MATE ≡
≡ ANTIDESLIZANTE ≡



Detalle a escala 1:1 ~ Detail scale 1:1 ~ Detail échelle 1:1 ~ Maßstab 1:1

	MATE	ANTIDESLIZANTE
NEGRO	●	●
GRAFITO	●	●
GRIS	●	●
NACAR	●	●
ARENA	●	●

# ROMA

PORCELÁNICO~PORCELAIN TILE~GRÉS CÉRAME~FEINSTEINZEUG

∞ Roma Arena 45x90 mate + Roma Arena 30x60 mate + Roma Negro 30x60 mate.



# ROMA

PORCELÁNICO~PORCELAIN TILE~GRÉS CÉRAME~FEINSTEINZEUG

≈ Roma Grafito 30x60 mate + Decorado Orbis Gris.



≈ Decorado Orbis Gris 30x60.



# ROMA

PORCELÁNICO≈PORCELAIN TILE≈GRÉS CÉRAME≈FEINSTEINZEUG

DESTONIFICACIÓN INTENCIONADA≈INTENTIONALLY NON-HOMOGENEOUS COLOUR≈  
DES VARIATIONS DE NUANCES INTENTIONNÉES≈DESIGNGEMÄßE ENTFÄRBUNG

## R19 NEGRO ≡

Reciclado

30x60 cm. (12x24") · MATE



### ACABADOS / FINISHES

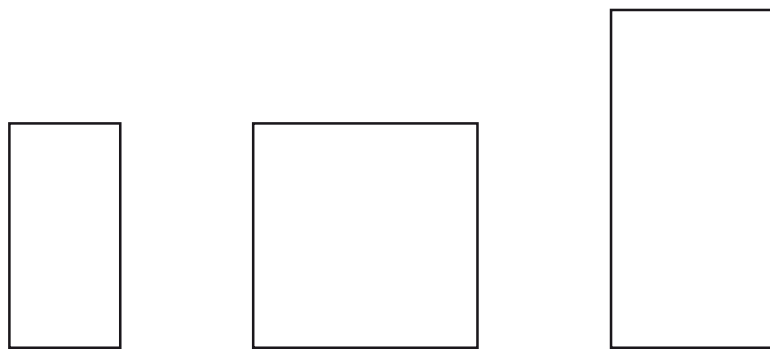

Mate B-44 Antideslizante B-48 30 x 60 cm (12" x 24")	Mate B-54 60 x 60 cm (24" x 24")	Mate B-58 45 x 90 cm (18" x 36")
---	--	--

### PACKING LIST

PIEZAS BASE≈BASIC TILES≈ELÉMENTS DE BASE≈GRUNDFLIESEN

CM	SIZE	ACABADO/FINISH	PIEZAS CAJA/ PIECES BOX	KG CAJA	M² CAJA	SQFT BOX	CAJAS/BOXES EUROPALET	M² EUROPALET	SQFT EUROPALLET	KG EUROPALET
30 x 60	12" x 24"	TODOS	6	24,00	1,08	11,62	48	51,84	558,00	1179,00
60 x 60	24" x 24"	MATE	4	33,20	1,44	15,50	32	46,08	496,00	1089,40
45 x 90	18" x 36"	MATE	2	20,50	0,81	8,72	39	31,59	340,03	826,50

## R14 GRAFITO ≡

Reciclado

30x60 cm. (12x24") · MATE



### ACABADOS / FINISHES

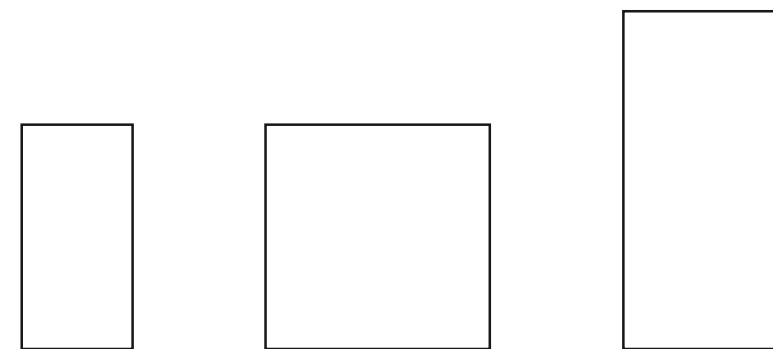

Mate B-44 Antideslizante B-48 30 x 60 cm (12" x 24")	Mate B-54 60 x 60 cm (24" x 24")	Mate B-58 45 x 90 cm (18" x 36")
---	--	--

### PACKING LIST

PIEZAS BASE≈BASIC TILES≈ELÉMENTS DE BASE≈GRUNDFLIESEN

CM	SIZE	ACABADO/FINISH	PIEZAS CAJA/ PIECES BOX	KG CAJA	M² CAJA	SQFT BOX	CAJAS/BOXES EUROPALET	M² EUROPALET	SQFT EUROPALLET	KG EUROPALET
30 x 60	12" x 24"	TODOS	6	24,00	1,08	11,62	48	51,84	558,00	1179,00
60 x 60	24" x 24"	MATE	4	33,20	1,44	15,50	32	46,08	496,00	1089,40
45 x 90	18" x 36"	MATE	2	20,50	0,81	8,72	39	31,59	340,03	826,50

# ROMA

PORCELÁNICO≈PORCELAIN TILE≈GRÉS CÉRAMÉ≈FEINSTEINZEUG

DESTONIFICACIÓN INTENCIONADA≈INTENTIONALLY NON-HOMOGENEOUS COLOUR≈  
DES VARIATIONS DE NUANCES INTENTIONNÉES≈DESIGNGEMÄBE ENTFÄRBUNG

## R11 GRIS ≈

30x60 cm. (12x24") · MATE



### ACABADOS / FINISHES

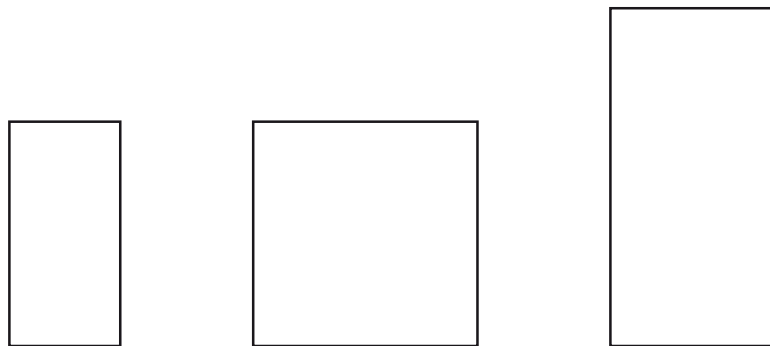

Mate B-44 Antideslizante B-48 30 x 60 cm (12" x 24")	Mate B-54 60 x 60 cm (24" x 24")	Mate B-58 45 x 90 cm (18" x 36")
---	--	--

### PACKING LIST

PIEZAS BASE≈BASIC TILES≈ELÉMENTS DE BASE≈GRUNDFLIESEN

CM	SIZE	ACABADO/FINISH	PIEZAS CAJA/ PIECES BOX	KG CAJA	M² CAJA	SQFT BOX	CAJAS/BOXES EUROPALET	M² EUROPALET	SQFT EUROPALLET	KG EUROPALET
30 x 60	12" x 24"	TODOS	6	24,00	1,08	11,62	48	51,84	558,00	1179,00
60 x 60	24" x 24"	MATE	4	33,20	1,44	15,50	32	46,08	496,00	1089,40
45 x 90	18" x 36"	MATE	2	20,50	0,81	8,72	39	31,59	340,03	826,50

## R15 NACAR ≈

30x60 cm. (12x24") · MATE



### ACABADOS / FINISHES

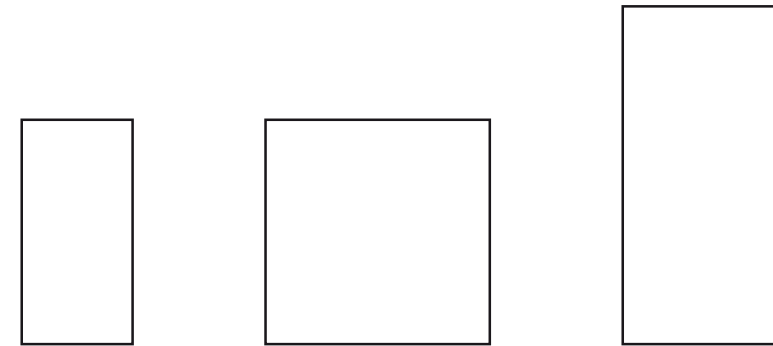

Mate B-47 Antideslizante B-51 30 x 60 cm (12" x 24")	Mate B-57 60 x 60 cm (24" x 24")	Mate B-63 45 x 90 cm (18" x 36")
---	--	--

### PACKING LIST

PIEZAS BASE≈BASIC TILES≈ELÉMENTS DE BASE≈GRUNDFLIESEN

CM	SIZE	ACABADO/FINISH	PIEZAS CAJA/ PIECES BOX	KG CAJA	M² CAJA	SQFT BOX	CAJAS/BOXES EUROPALET	M² EUROPALET	SQFT EUROPALLET	KG EUROPALET
30 x 60	12" x 24"	TODOS	6	24,00	1,08	11,62	48	51,84	558,00	1179,00
60 x 60	24" x 24"	MATE	4	33,20	1,44	15,50	32	46,08	496,00	1089,40
45 x 90	18" x 36"	MATE	2	20,50	0,81	8,72	39	31,59	340,03	826,50

# ROMA

PORCELÁNICO≈PORCELAIN TILE≈GRÉS CÉRAME≈FEINSTEINZEUG

DESTONIFICACIÓN INTENCIONADA≈INTENTIONALLY NON-HOMOGENEOUS COLOUR≈  
DES VARIATIONS DE NUANCES INTENTIONNÉES≈DESIGNEMÄßE ENTFÄRBUNG

## R12 ARENA ≈

30x60 cm. (12x24") · MATE



### ACABADOS / FINISHES

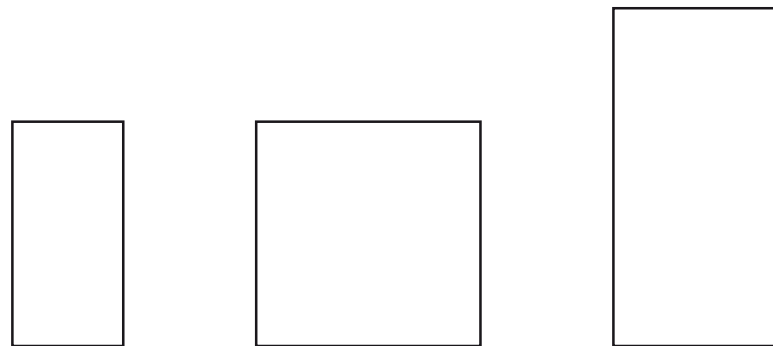

Mate B-44  
Antideslizante B-48  
30 x 60 cm  
(12" x 24")

Mate B-54  
60 x 60 cm  
(24" x 24")

Mate B-58  
45 x 90 cm  
(18" x 36")

### PACKING LIST

PIEZAS BASE≈BASIC TILES≈ELÉMENTS DE BASE≈GRUNDFLIESEN

CM	SIZE	ACABADO/FINISH	PIEZAS CAJA/ PIECES BOX		CAJAS/BOXES EUROPALET					KG EUROPALET
			KG CAJA	M² CAJA	M² EUROPALET	SQFT EUROPALET	SQFT EUROPALET	KG EUROPALET		
30 x 60	12" x 24"	TODOS	6	24,00	1,08	11,62	48	51,84	558,00	1179,00
60 x 60	24" x 24"	MATE	4	33,20	1,44	15,50	32	46,08	496,00	1089,40
45 x 90	18" x 36"	MATE	2	20,50	0,81	8,72	39	31,59	340,03	826,50

## PIEZAS COMPLEMENTARIAS≈ACCESSORIES≈ACCESSOIRES ET DECORATIONS≈FORMTEILE



MOSAICO NGN  
NEGRO/GRIS/NACAR  
30 x 30 cm (12" x 12")  
P-13

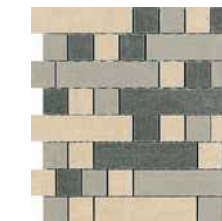

MOSAICO AGG  
ARENA/GRIS/GRAFITO  
30 x 30 cm (12" x 12")  
P-13



DECORADO ORBIS  
NEGRO  
30 x 60 cm (12" x 24")  
P-26

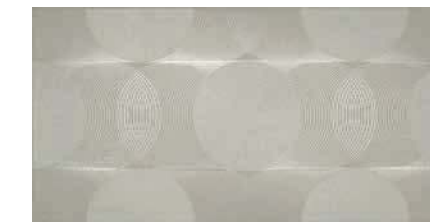

DECORADO ORBIS  
GRIS  
30 x 60 cm (12" x 24")  
P-26

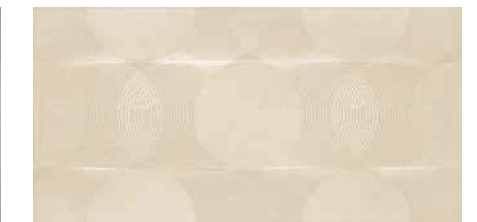

DECORADO ORBIS  
NACAR  
30 x 60 cm (12" x 24")  
P-26



CENEFA ORBIS  
NEGRO  
9 x 60 cm (3,3" x 24")  
P-11

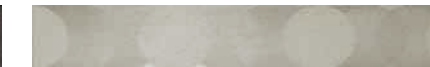

CENEFA ORBIS  
GRIS  
9 x 60 cm (3,3" x 24")  
P-11

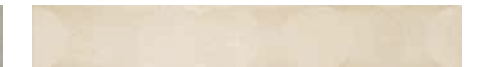

CENEFA ORBIS  
NACAR  
9 x 60 cm (3,3" x 24")  
P-11



CENEFA ORBIS  
GRAFITO  
9 x 60 cm (3,3" x 24")  
P-11



CENEFA ORBIS  
ARENA  
9 x 60 cm (3,3" x 24")  
P-11

### PACKING LIST

COMPLEMENTOS DECORATIVOS≈DECORATIVE ACCESSORIES≈COMPLÉMENTS DE DÉCORATION≈FORMTEILE

PIEZA/PIECE	CM	SIZE	PRECIO/ PRICE	PIEZA/PIECE	CM	SIZE	PRECIO/ PRICE
Cenefa Orbis Negro	9x60	3,3" x 24"	P-11	Decorado Orbis Negro	30x60	12" x 24"	P-26
Cenefa Orbis Gris	9x60	3,3" x 24"	P-11	Decorado Orbis Gris	30x60	12" x 24"	P-26
Cenefa Orbis Nacar	9x60	3,3" x 24"	P-11	Decorado Orbis Nacar	30x60	12" x 24"	P-26
Cenefa Orbis Grafito	9x60	3,3" x 24"	P-11	Mosaico NGN	30x30	12" x 12"	P-13
Cenefa Orbis Arena	9x60	3,3" x 24"	P-11	Mosaico AGG	30x30	12" x 12"	P-13

≈ Roma Gris 30x60 mate + Cenefa Orbis Gris + Roma Nacar 30x60 mate.

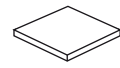
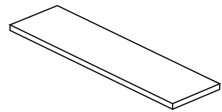
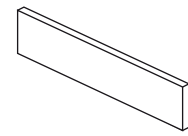
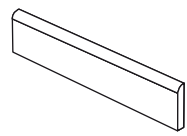
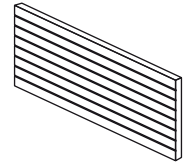
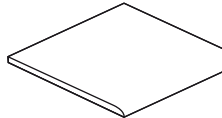
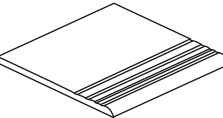
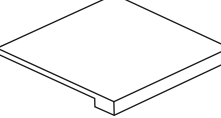

## PIEZAS COMPLEMENTARIAS~DECORATIVE ACCESSORIES ≈

 <p><b>Taco</b> Insert 8 x 8 cm (3,2" x 3,2")</p>	 <p><b>Listel</b> Listel 8 x 30 cm (3,2" x 12") 8 x 45 cm (3,2" x 18") 8 x 60 cm (3,2" x 24") 8 x 90 cm (3,2" x 36")</p>	 <p><b>Rodapié Cortado</b> Straight skirting 8 x 30 cm (3,2" x 12") 8 x 45 cm (3,2" x 18") 8 x 60 cm (3,2" x 24") 8 x 90 cm (3,2" x 36")</p>	 <p><b>Rodapié Canto Romo</b> Skirting bullnose 8 x 30 cm (3,2" x 12") 8 x 45 cm (3,2" x 18") 8 x 60 cm (3,2" x 24") 8 x 90 cm (3,2" x 36")</p>
 <p><b>Incisión</b> Incision 30 x 60 cm (12" x 24")</p>	 <p><b>Canto Romo</b> Rounded edge piece 30 x 60 cm (12" x 24") 45 x 90 cm (18" x 36") 60 x 60 cm (24" x 24")</p>	 <p><b>Peldaño Ranurado</b> Grooved stair tread 30 x 60 cm (12" x 24") 45 x 90 cm (18" x 36") 60 x 60 cm (24" x 24")</p>	 <p><b>Peldaño Elit con o sin ranura</b> Grooved Elit Stair/Plain Elit Stair 30 x 60 cm (12" x 24") 45 x 90 cm (18" x 36") 60 x 60 cm (24" x 24")</p>

## PACKING LIST

PIEZAS ESPECIALES~SPECIAL ACCESSORIES~ÉLÉMENTS SPÉCIAUX~SPEZIALTEILE

PIEZA/PIECE	CM	SIZE	ACABADO/ FINISH	PRECIO/ PRICE	PIEZA/PIECE	CM	SIZE	ACABADO/ FINISH	PRECIO/ PRICE
Taco - Insert	8x8	3,2" x 3,2"	TODOS	P-02	Canto Romo 2 lados - Rounded edge piece 2 sides	30x60	12" x 24"	TODOS	P-23
Rodapié Cortado - Straight skirting	8x30	3,2" x 12"	TODOS	P-02	Canto Romo 2 lados - Rounded edge piece 2 sides	45x90	18" x 36"	MATE	P-45
Rodapié Cortado - Straight skirting	8x45	3,2" x 18"	MATE	P-04	Canto Romo 2 lados - Rounded edge piece 2 sides	60x60	24" x 24"	MATE	P-38
Rodapié Cortado - Straight skirting	8x60	3,2" x 24"	TODOS	P-04	Peldaño Ranurado - Grooved stair tread	30x60	12" x 24"	TODOS	P-16
Rodapié Cortado - Straight skirting	8x90	3,2" x 36"	MATE	P-08	Peldaño Ranurado - Grooved stair tread	45x90	18" x 36"	MATE	P-35
Rodapié Canto Romo - Skirting bullnose	8x30	3,2" x 12"	TODOS	P-03	Peldaño Ranurado - Grooved stair tread	60x60	24" x 24"	MATE	P-31
Rodapié Canto Romo - Skirting bullnose	8x45	3,2" x 18"	MATE	P-05	Peldaño Ranurado Esquina - Grooved stair tread corner	30x60	12" x 24"	TODOS	P-23
Rodapié Canto Romo - Skirting bullnose	8x60	3,2" x 24"	TODOS	P-05	Peldaño Ranurado Esquina - Grooved stair tread corner	45x90	18" x 36"	MATE	P-45
Rodapié Canto Romo - Skirting bullnose	8x90	3,2" x 36"	MATE	P-10	Peldaño Ranurado Esquina - Grooved stair tread corner	60x60	24" x 24"	MATE	P-38
Listel	8x30	3,2" x 12"	TODOS	P-02	Peldaño Elit (lado 30) - Elit step (12" side)	30x60	12" x 24"	TODOS	P-29
Listel	8x45	3,2" x 18"	MATE	P-04	Peldaño Elit (lado 60) - Elit step (24" side)	30x60	12" x 24"	TODOS	P-46
Listel	8x60	3,2" x 24"	TODOS	P-04	Peldaño Elit (lado 45) - Elit step (18" side)	45x90	18" x 36"	MATE	P-54
Listel	8x90	3,2" x 36"	MATE	P-08	Peldaño Elit (lado 90) - Elit step (36" side)	45x90	18" x 36"	MATE	P-81
Incisión	30x60	12" x 24"	TODOS	P-13	Peldaño Elit - Elit step	60x60	24" x 24"	MATE	P-62
Canto Romo 1 lado - Rounded edge piece 1 side	30x60	12" x 24"	TODOS	P-16	Peldaño Elit Esquina - Elit step corner	30x60	12" x 24"	TODOS	P-67
Canto Romo 1 lado - Rounded edge piece 1 side	45x90	18" x 36"	MATE	P-35	Peldaño Elit Esquina - Elit step corner	45x90	18" x 36"	MATE	P-114
Canto Romo 1 lado - Rounded edge piece 1 side	60x60	24" x 24"	MATE	P-31	Peldaño Elit Esquina - Elit step corner	60x60	24" x 24"	MATE	P-104

Estas piezas se venden por unidad, a excepción de los rodapiés que se venden en cajas de 10 uds.  
These items are sold by pieces with the exception of the skirtings which are sold by boxes of 10 pieces each.  
Unité de vente à la pièce, sauf les plinthes vendus à la boîte de 10 unités.  
Die Formteile sind pro Stück verkauft außer die Sockel, die pro Karton mit 10 Stück verkauft sind.

≈ Silex Gris 30x60 rústico.





**CARACTERÍSTICAS TÉCNICAS**  
TECHNICAL CHARACTERISTICS

FORMATOS≈SIZES

30 x 60 cm (12" x 24")

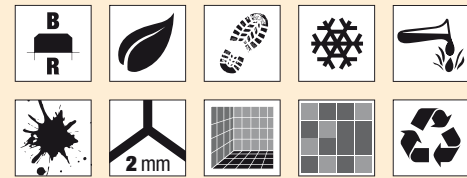

Consulte página 10≈See page 10≈  
Voir page 10≈Sehen Sie Seite 10

ÁMBITOS DE USO≈AREA OF USE



**RÚSTICO**

Idóneo para interiores húmedos, escaleras, entradas y exteriores cubiertos.

*Suitable for wet indoor areas, steps and entrance areas.*

*Idéal pour intérieurs humides / escalier et entrées.*

*Ideal für feuchte Innerräume, Treppenhäuser und Eingänge.*

NORMA≈NORM

NORMA UNE-ENV 12633:2003  
- Silex Rústico: Clase 2

NORMA DIN 51130  
- Silex Rústico: R - 10

MODELOS MODELS

GRAFITO

GRIS

ARENA

TABACO



≈ RÚSTICO ≈

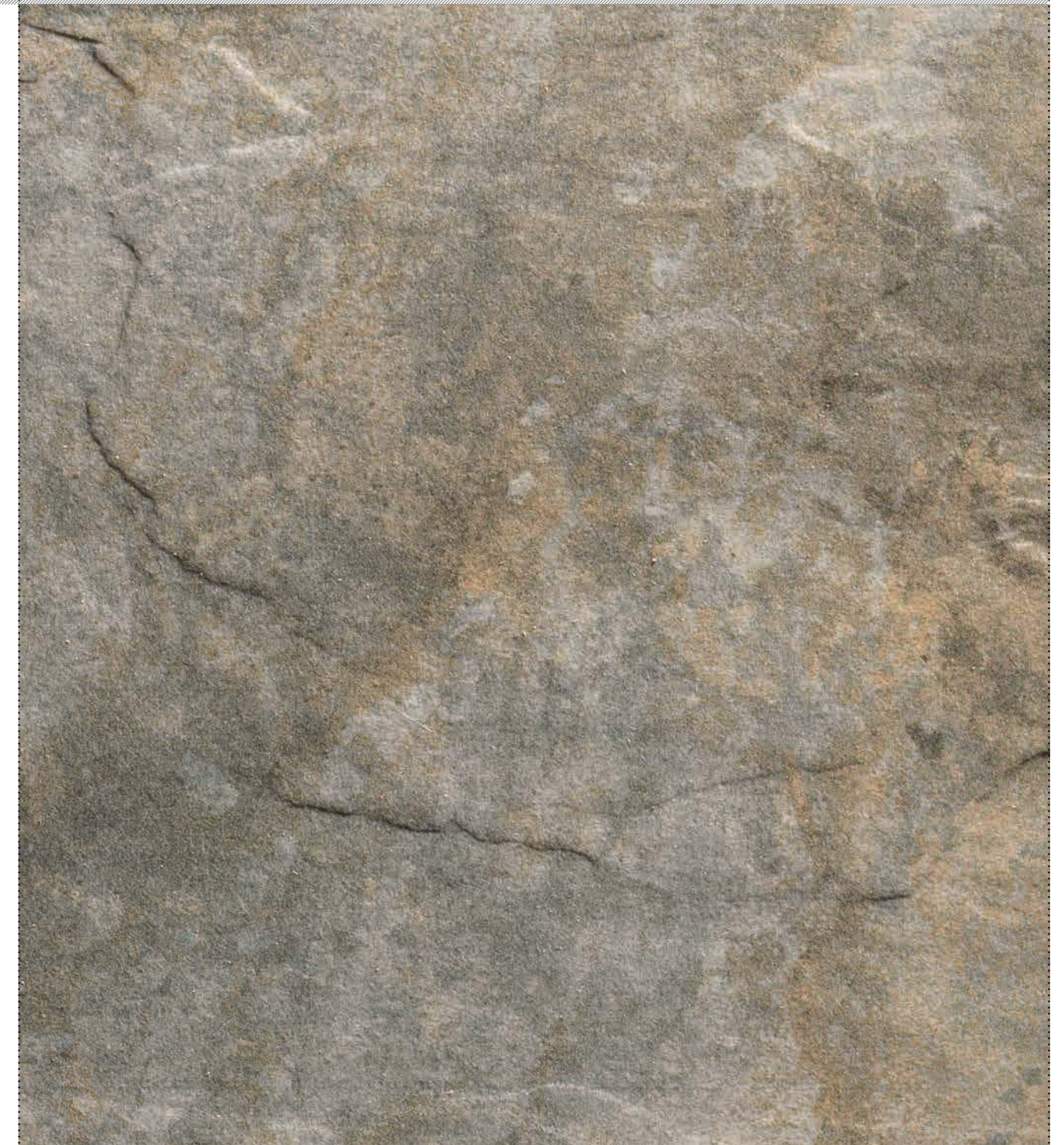

Detalle a escala 1:1 ≈ Detail scale 1:1 ≈ Detail échelle 1:1 ≈ Maßstab 1:1

	RÚSTICO
GRAFITO	●
GRIS	●
ARENA	●
TABACO	●

# SILEX

PORCELÁNICO~PORCELAIN TILE~GRÉS CÉRAME~FEINSTEINZEUG

≡ Silex Gris 30x60 rústico.



≡ Silex Grafito 30x60 rústico.

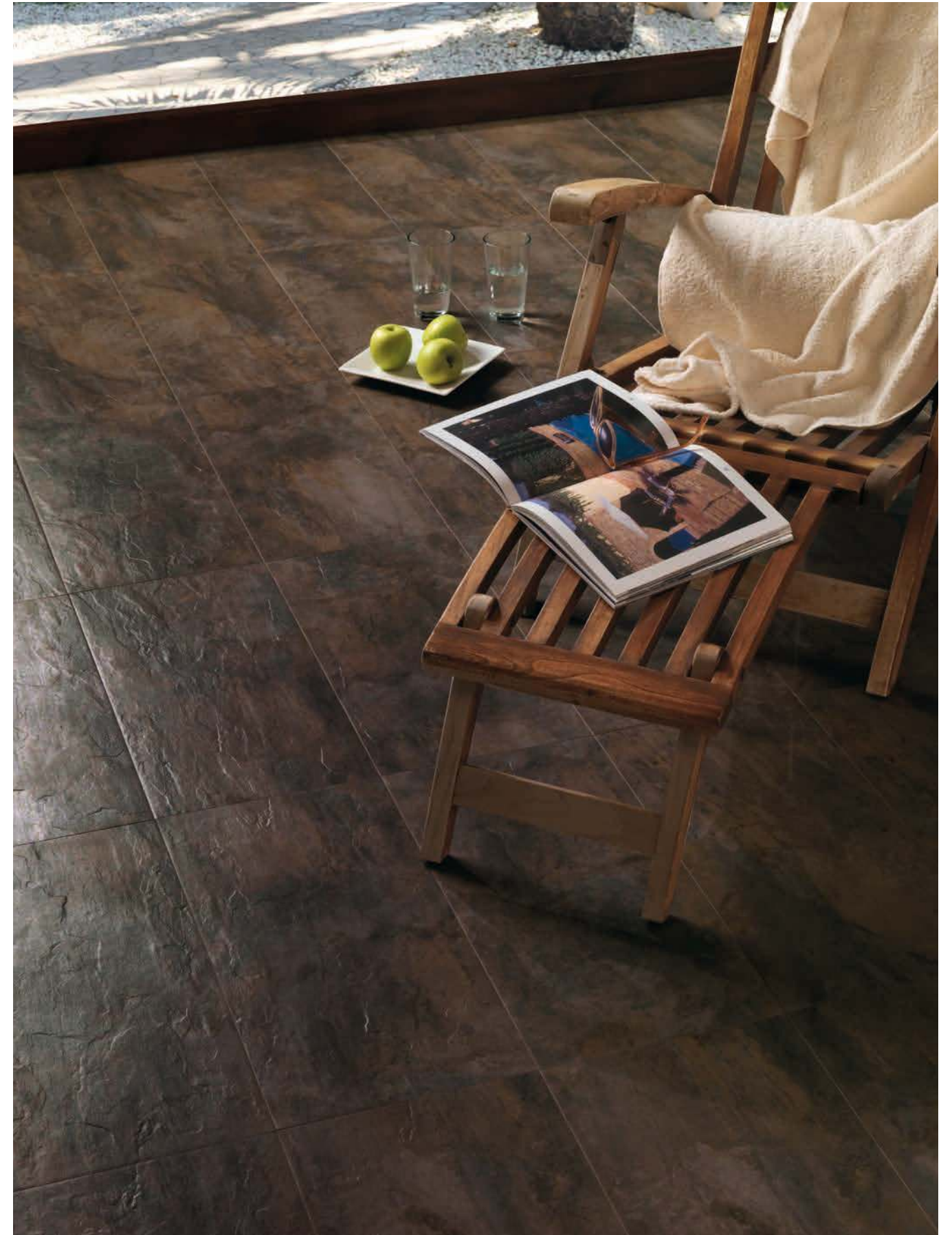

## N24 GRAFITO ≡

 Reciclado

30x60 cm. (12x24") · RÚSTICO



### ACABADOS / FINISHES



RÚSTICO

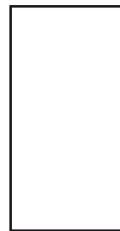

Rústico B-48  
30 x 60 cm  
(12" x 24")

### PACKING LIST

PIEZAS BASE≈BASIC TILES≈ELÉMENTS DE BASE≈GRUNDFLIESEN

CM	SIZE	ACABADO/FINISH	PIEZAS CAJA/ PIECES BOX	KG CAJA	M² CAJA	SQFT BOX	CAJAS/BOXES EUROPALET	M² EUROPALET	SQFT EUROPALLET	KG EUROPALET
30 x 60	12" x 24"	RÚSTICO	6	24,00	1,08	11,62	48	51,84	558,00	1179,00

## N21 GRIS ≡

30x60 cm. (12x24") · RÚSTICO



### ACABADOS / FINISHES



RÚSTICO



Rústico B-48  
30 x 60 cm  
(12" x 24")

### PACKING LIST

PIEZAS BASE≈BASIC TILES≈ELÉMENTS DE BASE≈GRUNDFLIESEN

CM	SIZE	ACABADO/FINISH	PIEZAS CAJA/ PIECES BOX	KG CAJA	M² CAJA	SQFT BOX	CAJAS/BOXES EUROPALET	M² EUROPALET	SQFT EUROPALLET	KG EUROPALET
30 x 60	12" x 24"	RÚSTICO	6	24,00	1,08	11,62	48	51,84	558,00	1179,00

## N22 ARENA ≈

30x60 cm. (12x24") · RÚSTICO



### ACABADOS / FINISHES



RÚSTICO



Rústico B-48  
30 x 60 cm  
(12" x 24")

## N23 TABACO ≈

30x60 cm. (12x24") · RÚSTICO



### ACABADOS / FINISHES



RÚSTICO



Rústico B-48  
30 x 60 cm  
(12" x 24")

### PACKING LIST

PIEZAS BASE≈BASIC TILES≈ELÉMENTS DE BASE≈GRUNDFLIESEN

CM	SIZE	ACABADO/FINISH	PIEZAS CAJA/ PIECES BOX	KG CAJA	M² CAJA	SQFT BOX	CAJAS/BOXES EUROPALET	M² EUROPALET	SQFT EUROPALET	KG EUROPALET
30 x 60	12" x 24"	RÚSTICO	6	24,00	1,08	11,62	48	51,84	558,00	1179,00

### PACKING LIST

PIEZAS BASE≈BASIC TILES≈ELÉMENTS DE BASE≈GRUNDFLIESEN

CM	SIZE	ACABADO/FINISH	PIEZAS CAJA/ PIECES BOX	KG CAJA	M² CAJA	SQFT BOX	CAJAS/BOXES EUROPALET	M² EUROPALET	SQFT EUROPALET	KG EUROPALET
30 x 60	12" x 24"	RÚSTICO	6	24,00	1,08	11,62	48	51,84	558,00	1179,00

PIEZAS COMPLEMENTARIAS≈ACCESSORIES≈ACCESSOIRES ET DECORATIONS≈FORMTEILE



MOSAICO SILEX  
TABACO  
30 x 30 cm (12" x 12")  
P-13



MOSAICO SILEX  
MULTICOLOR  
30 x 30 cm (12" x 12")  
P-13

≈ Silex Tabaco 30x60 rústico.



PIEZAS COMPLEMENTARIAS≈ACCESSORIES≈ACCESSOIRES ET DECORATIONS≈FORMTEILE

**PACKING LIST**

COMPLEMENTOS DECORATIVOS≈DECORATIVE ACCESSORIES≈COMPLÉMENTS DE DÉCORATION≈FORMTEILE

PIEZA/PIECE	CM	SIZE	PRECIO/ PRICE
Mosaico Silex Tabaco	30x30	12" x 12"	P-13
Mosaico Silex Multicolor	30x30	12" x 12"	P-13

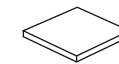

**Taco**  
*Insert*  
8 x 8 cm (3,2" x 3,2")

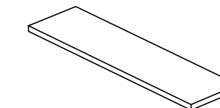

**Listel**  
*Listel*  
8 x 30 cm (3,2" x 12")  
8 x 60 cm (3,2" x 24")

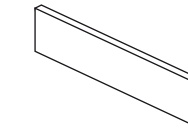

**Rodapié Cortado**  
*Straight skirting*  
8 x 30 cm (3,2" x 12")  
8 x 60 cm (3,2" x 24")

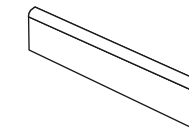

**Rodapié Canto Romo**  
*Skirting bullnose*  
8 x 30 cm (3,2" x 12")  
8 x 60 cm (3,2" x 24")

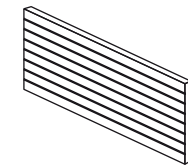

**Incisión**  
*Incision*  
30 x 60 cm (12" x 24")

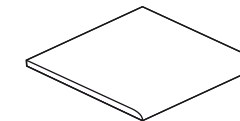

**Canto Romo**  
*Rounded edge piece*  
30 x 60 cm (12" x 24")

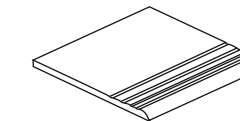

**Peldaño Ranurado**  
*Grooved stair tread*  
30 x 60 cm (12" x 24")

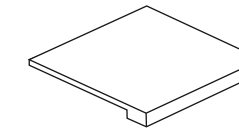

**Peldaño Elit con o sin ranura**  
*Grooved Elit Stair/Plain Elit Stair*  
30 x 60 cm (12" x 24")

**PACKING LIST**

PIEZAS ESPECIALES≈SPECIAL ACCESSORIES≈ÉLÉMENTS SPÉCIAUX≈SPEZIALTEILE

PIEZA/PIECE	CM	SIZE	ACABADO/ FINISH	PRECIO/ PRICE	PIEZA/PIECE	CM	SIZE	ACABADO/ FINISH	PRECIO/ PRICE
Taco - Insert	8x8	3,2" x 3,2"	RÚSTICO	P-02	Canto Romo 1 lado - Rounded edge piece 1 side	30x60	12" x 24"	RÚSTICO	P-16
Rodapié Cortado - Straight skirting	8x30	3,2" x 12"	RÚSTICO	P-02	Canto Romo 2 lados - Rounded edge piece 2 sides	30x60	12" x 24"	RÚSTICO	P-23
Rodapié Cortado - Straight skirting	8x60	3,2" x 24"	RÚSTICO	P-04	Peldaño Ranurado - Grooved stair tread	30x60	12" x 24"	RÚSTICO	P-16
Rodapié Canto Romo - Skirting bullnose	8x30	3,2" x 12"	RÚSTICO	P-03	Peldaño Ranurado Esquina - Grooved stair tread corner	30x60	12" x 24"	RÚSTICO	P-23
Rodapié Canto Romo - Skirting bullnose	8x60	3,2" x 24"	RÚSTICO	P-05	Peldaño Elit (lado 30) - Elit step (12" side)	30x60	12" x 24"	RÚSTICO	P-29
Listel	8x30	3,2" x 12"	RÚSTICO	P-02	Peldaño Elit (lado 60) - Elit step (24" side)	30x60	12" x 24"	RÚSTICO	P-47
Listel	8x60	3,2" x 24"	RÚSTICO	P-04	Peldaño Elit Esquina - Elit step corner	30x60	12" x 24"	RÚSTICO	P-67
Incisión	30x60	12" x 24"	RÚSTICO	P-13					

Estas piezas se venden por unidad, a excepción de los rodapiés que se venden en cajas de 10 uds.  
These items are sold by pieces with the exception of the skirtings which are sold by boxes of 10 pieces each.  
Unité de vente à la pièce, sauf les plinthes vendus à la boîte de 10 unités.  
Die Formteile sind pro Stück verkauft außer die Sockel, die pro Karton mit 10 Stück verkauft sind.

✓ Ríos Hudson 40x40 pulido.



**CARACTERÍSTICAS TÉCNICAS**  
TECHNICAL CHARACTERISTICS

**FORMATOS≈SIZES**  
30 x 30 cm (12" x 12")  
40 x 40 cm (16" x 16")  
60 x 60 cm (24" x 24")

Consulte página 10≈See page 10≈  
Voir page 10≈Sehen Sie Seite 10

**ÁMBITOS DE USO≈AREA OF USE**

**PULIDO / MATE**  
Idóneo para zonas interiores secas.  
*Suitable for dry indoor areas.*  
*Idéal pour application intérieure sèche.*  
*Ideal für trockene Innenräume.*

**ANTI-SLIP**  
45°

**ANTIDESLIZANTE / TRAFIC**  
Recomendado para interiores húmedos, exteriores y piscinas.  
*Suitable for wet indoor areas, outdoor areas and swimming pools.*  
*Idéal pour application intérieure humide et pour extérieurs et piscines.*  
*Ideal für Nassbereiche, innen sowie außen und in Schwimmbädern.*

**NORMA≈NORM**

**NORMA UNE-ENV 12633:2003**  
- Ríos Mate: Clase 1  
- Ríos Antideslizante: Clase 3  
- Ríos Trafic: Clase 3

**NORMA DIN 51130**  
- Ríos Mate: R - 9  
- Ríos Trafic: R - 12

**NORMA DIN 51097 (Pie descalzo)**  
- Ríos Trafic: Grupo C

FORMATO	MATE	PULIDO
40X40	U4 P4 E3 C2	U3 P3 E3 C2
60X60	U4 P4+ E3 C2	U3 P3 E3 C2

**MODELOS**  
MODELS

NILO

PARANÁ

MIJARES

SEGRE

LOA

HUDSON

TER

GENIL

TIBER

**ACABADOS FINISHES**

MATE

ANTIDESLIZANTE

PULIDO

TRAFIC

Detalle a escala 1:1 ≈ Detail scale 1:1 ≈ Detail échelle 1:1 ≈ Maßstab 1:1

	MATE	PULIDO	ANTIDESLIZANTE	TRAFIC	ESPESORADO 12 MM.	ESPESORADO 14 MM.
NILO	●	●				
PARANÁ	●	●	●			●
MIJARES	●	●	●	●	●	●
SEGRE	●	●	●	●	●	●
LOA	●	●	●		●	●
HUDSON	●	●	●			●
TER	●	●				
GENIL	●	●				
TIBER	●	●				

≈ Ríos Mijares 40x40 pulido.

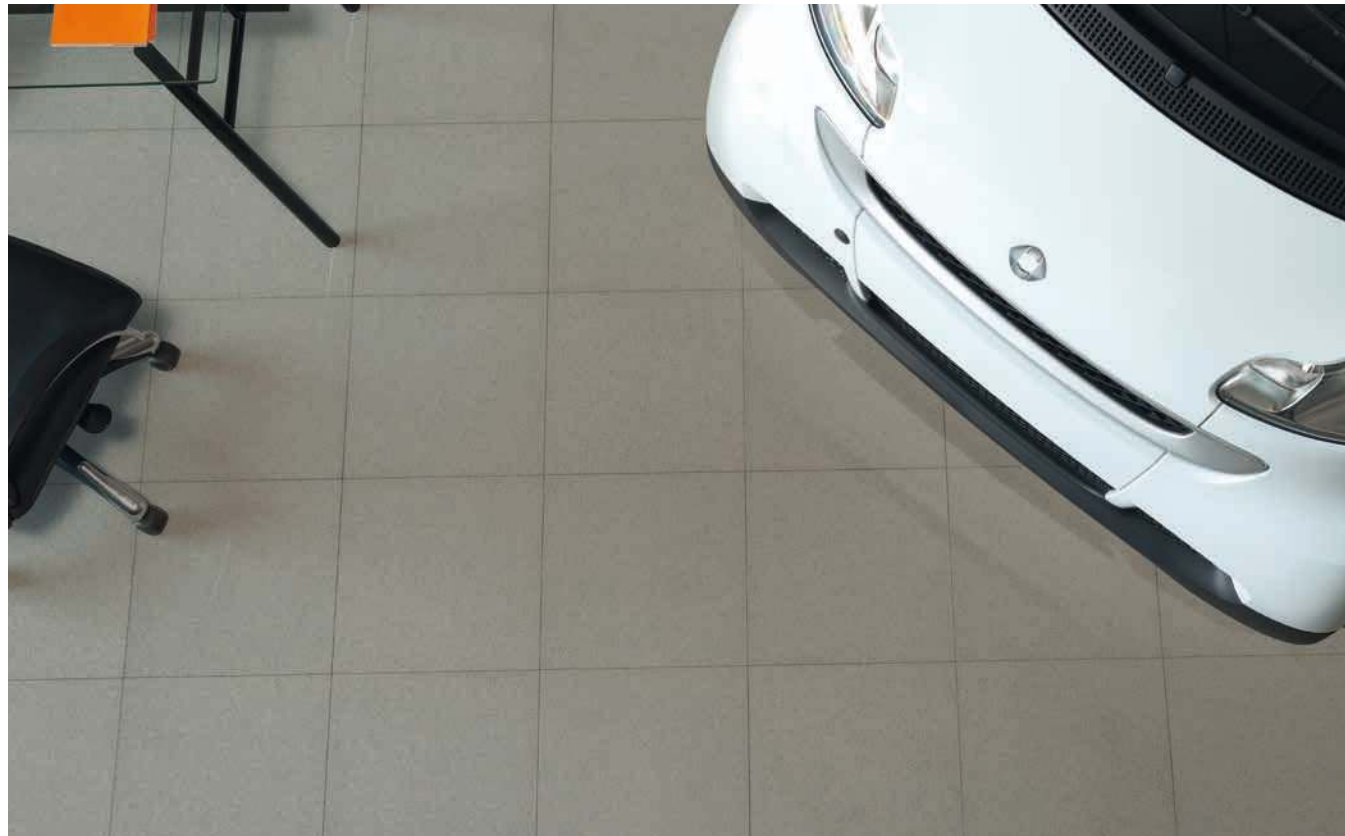

≈ Ríos Segre 30x30 trafic.



≈ Ríos Hudson 40x40 mate.





## 235 NILO ≡



40x40 cm. (16x16") · MATE



### ACABADOS / FINISHES



Mate B-27  
Pulido B-47  
40 x 40 cm  
(16" x 16")

## 267 PARANÁ ≡



40x40 cm. (16x16") · MATE



### ACABADOS / FINISHES



Mate B-25  
Pulido B-43  
Antideslizante B-27  
40 x 40 cm  
(16" x 16")

14 mm.



Esp. Mate B-49  
Esp. Pulido B-57  
40 x 40 cm  
(16" x 16")

## 244 TIBER ≡



40x40 cm. (16x16") · MATE



### ACABADOS / FINISHES



Mate B-27  
Pulido B-43  
40 x 40 cm  
(16" x 16")

## 220 TER ≡



40x40 cm. (16x16") · MATE



### ACABADOS / FINISHES

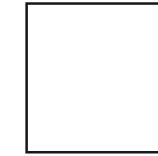

Mate B-26  
Pulido B-42  
40 x 40 cm  
(16" x 16")

### PACKING LIST

PIEZAS BASE≈BASIC TILES≈ELÉMENTS DE BASE≈GRUNDFLIESEN

CM	SIZE	ACABADO/FINISH	PIEZAS CAJA/ PIECES BOX	KG CAJA	M² CAJA	SQFT BOX	CAJAS/BOXES EUROPALET	M² EUROPALET	SQFT EUROPALLET	KG EUROPALET
40 x 40	16" x 16"	MATE / ANTID	6	19,80	0,96	10,33	72	69,12	744,00	1452,60
40 x 40	16" x 16"	PULIDO	6	17,40	0,96	10,33	72	69,12	744,00	1279,80
40 x 40	16" x 16"	ESP 14 MM MATE	4	20,60	0,64	6,89	72	46,08	496,00	1510,20
40 x 40	16" x 16"	ESP 14 MM PULIDO	4	18,80	0,64	6,89	72	46,08	496,00	1380,60

### PACKING LIST

PIEZAS BASE≈BASIC TILES≈ELÉMENTS DE BASE≈GRUNDFLIESEN

CM	SIZE	ACABADO/FINISH	PIEZAS CAJA/ PIECES BOX	KG CAJA	M² CAJA	SQFT BOX	CAJAS/BOXES EUROPALET	M² EUROPALET	SQFT EUROPALLET	KG EUROPALET
40 x 40	16" x 16"	MATE	6	19,80	0,96	10,33	72	69,12	744,00	1452,60
40 x 40	16" x 16"	PULIDO	6	17,40	0,96	10,33	72	69,12	744,00	1279,80

## 209 GENIL ≈

40x40 cm. (16x16") · MATE



### ACABADOS / FINISHES

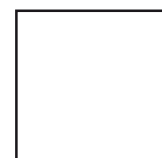

Mate B-27  
Pulido B-42  
40 x 40 cm  
(16" x 16")

## 251 LOA ≈

40x40 cm. (16x16") · MATE



### ACABADOS / FINISHES

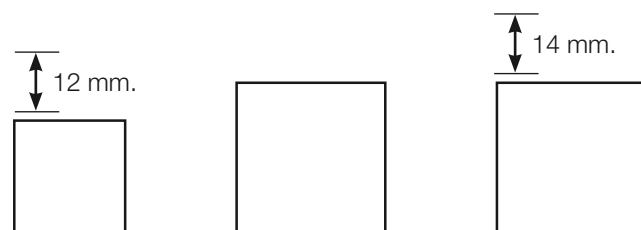

Esp. Mate B-46  
30 x 30 cm  
(12" x 12")  
Mate B-28  
Pulido B-40  
Antideslizante B-30  
40 x 40 cm  
(16" x 16")  
Esp. Mate B-49  
Esp. Pulido B-57  
40 x 40 cm  
(16" x 16")

### PACKING LIST

PIEZAS BASE≈BASIC TILES≈ÉLÉMENTS DE BASE≈GRUNDFLIESEN

CM	SIZE	ACABADO/FINISH	PIEZAS CAJA/ PIECES BOX	KG CAJA	M² CAJA	SQFT BOX	CAJAS/BOXES EUROPALET	M² EUROPALET	SQFT EUROPALLET	KG EUROPALET
30 x 30	12" x 12"	ESP 12 MM MATE	10	25,00	0,90	9,69	40	36,00	387,50	1027,00
30 x 30	12" x 12"	TRAFIC	13	24,70	1,17	12,59	40	46,80	503,75	1015,00
40 x 40	16" x 16"	MATE / ANTID	6	19,80	0,96	10,33	72	69,12	744,00	1452,60
40 x 40	16" x 16"	PULIDO	6	17,40	0,96	10,33	72	69,12	744,00	1279,80
40 x 40	16" x 16"	ESP 14 MM MATE	4	20,60	0,64	6,89	72	46,08	496,00	1510,20
40 x 40	16" x 16"	ESP 14 MM PULIDO	4	18,80	0,64	6,89	72	46,08	496,00	1380,60
60 x 60	24" x 24"	MATE	4	33,20	1,44	15,50	32	46,08	496,00	1089,40
60 x 60	24" x 24"	PULIDO	4	30,40	1,44	15,50	32	46,08	496,00	999,80

## 228 MIJARES ≈



40x40 cm. (16x16") · MATE



### ACABADOS / FINISHES

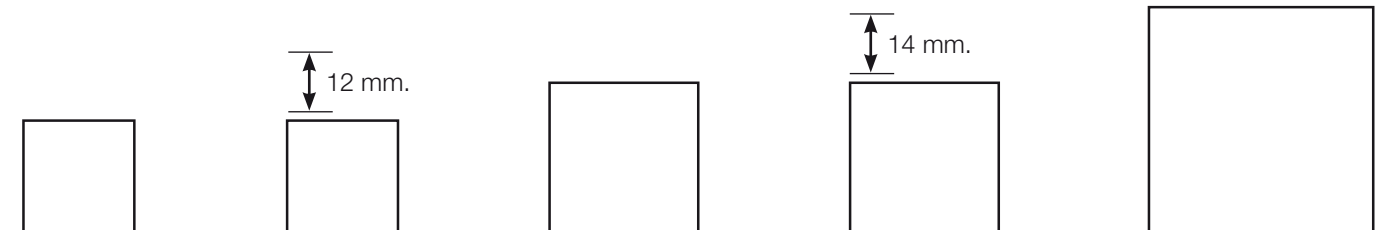

Trafic B-38  
30 x 30 cm  
(12" x 12")  
Esp. Mate B-42  
30 x 30 cm  
(12" x 12")  
Mate B-25  
Pulido B-39  
Antideslizante B-27  
40 x 40 cm  
(16" x 16")  
Esp. Mate B-49  
Esp. Pulido B-57  
40 x 40 cm  
(16" x 16")  
Mate B-52  
Pulido B-61  
60 x 60 cm  
(24" x 24")

### PACKING LIST

PIEZAS BASE≈BASIC TILES≈ÉLÉMENTS DE BASE≈GRUNDFLIESEN

CM	SIZE	ACABADO/FINISH	PIEZAS CAJA/ PIECES BOX	KG CAJA	M² CAJA	SQFT BOX	CAJAS/BOXES EUROPALET	M² EUROPALET	SQFT EUROPALLET	KG EUROPALET
30 x 30	12" x 12"	ESP 12 MM MATE	10	25,00	0,90	9,69	40	36,00	387,50	1027,00
30 x 30	12" x 12"	TRAFIC	13	24,70	1,17	12,59	40	46,80	503,75	1015,00
40 x 40	16" x 16"	MATE / ANTID	6	19,80	0,96	10,33	72	69,12	744,00	1452,60
40 x 40	16" x 16"	PULIDO	6	17,40	0,96	10,33	72	69,12	744,00	1279,80
40 x 40	16" x 16"	ESP 14 MM MATE	4	20,60	0,64	6,89	72	46,08	496,00	1510,20
40 x 40	16" x 16"	ESP 14 MM PULIDO	4	18,80	0,64	6,89	72	46,08	496,00	1380,60
60 x 60	24" x 24"	MATE	4	33,20	1,44	15,50	32	46,08	496,00	1089,40
60 x 60	24" x 24"	PULIDO	4	30,40	1,44	15,50	32	46,08	496,00	999,80

## 250 SEGRE ≈

40x40 cm. (16x16") · MATE



### ACABADOS / FINISHES

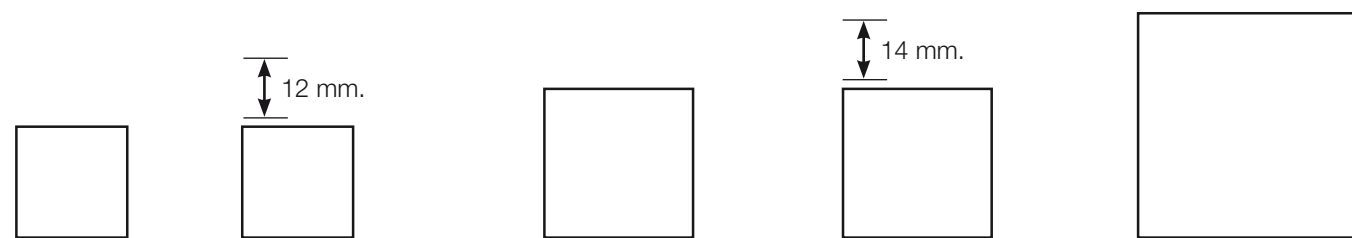

Trafic B-38 30 x 30 cm (12" x 12")	Esp. Mate B-42 Esp. Pulido B-54 Esp. Antideslizante B-46 30 x 30 cm (12" x 12")	Mate B-25 Pulido B-39 Antideslizante B-27 40 x 40 cm (16" x 16")	Esp. Mate B-49 Esp. Pulido B-57 40 x 40 cm (16" x 16")	Mate B-52 Pulido B-61 60 x 60 cm (24" x 24")
--	---	--	---	---

### PACKING LIST

PIEZAS BASE≈BASIC TILES≈ÉLÉMENTS DE BASE≈GRUNDFLIESEN

CM	SIZE	ACABADO/FINISH	PIEZAS CAJA/ PIECES BOX	KG CAJA	M² CAJA	SQFT BOX	CAJAS/BOXES EUROPALET	M² EUROPALET	SQFT EUROPALLET	KG EUROPALET
30 x 30	12" x 12"	ESP 12 MM MATE / ANTID	10	25,00	0,90	9,69	40	36,00	387,50	1027,00
30 x 30	12" x 12"	ESP 12 MM PULIDO	10	23,00	0,90	9,69	40	36,00	387,50	947,00
30 x 30	12" x 12"	TRAFIC	13	24,70	1,17	12,59	40	46,80	503,75	1015,00
40 x 40	16" x 16"	MATE / ANTID	6	19,80	0,96	10,33	72	69,12	744,00	1452,60
40 x 40	16" x 16"	PULIDO	6	17,40	0,96	10,33	72	69,12	744,00	1279,80
40 x 40	16" x 16"	ESP 14 MM MATE	4	20,60	0,64	6,89	72	46,08	496,00	1510,20
40 x 40	16" x 16"	ESP 14 MM PULIDO	4	18,80	0,64	6,89	72	46,08	496,00	1380,60
60 x 60	24" x 24"	MATE	4	33,20	1,44	15,50	32	46,08	496,00	1089,40
60 x 60	24" x 24"	PULIDO	4	30,40	1,44	15,50	32	46,08	496,00	999,80

## 263 HUDSON ≈

40x40 cm. (16x16") · MATE

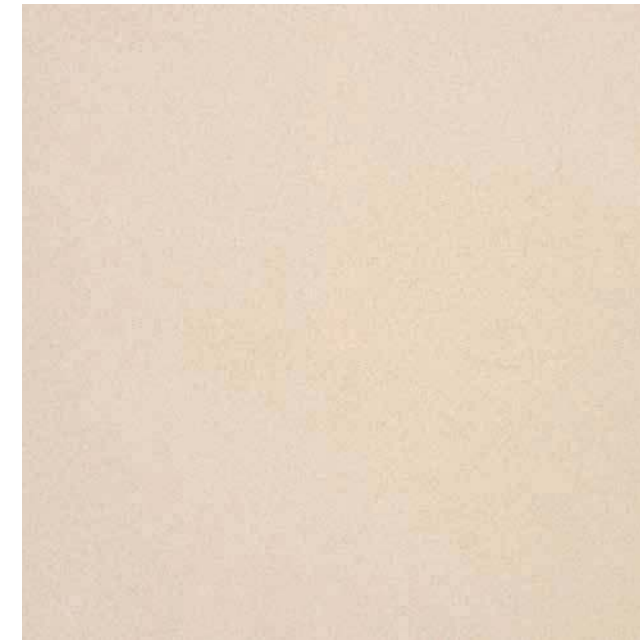

### ACABADOS / FINISHES

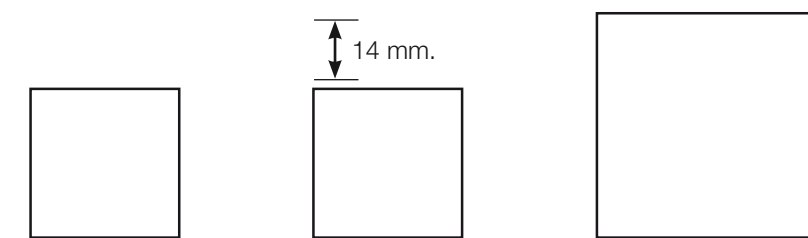

Mate B-27 Pulido B-39 Antideslizante B-29 40 x 40 cm (16" x 16")	Esp. Mate B-49 Esp. Pulido B-57 40 x 40 cm (16" x 16")	Mate B-52 Pulido B-61 60 x 60 cm (24" x 24")
--	---	---

### PACKING LIST

PIEZAS BASE≈BASIC TILES≈ÉLÉMENTS DE BASE≈GRUNDFLIESEN

CM	SIZE	ACABADO/FINISH	PIEZAS CAJA/ PIECES BOX	KG CAJA	M² CAJA	SQFT BOX	CAJAS/BOXES EUROPALET	M² EUROPALET	SQFT EUROPALLET	KG EUROPALET
40 x 40	16" x 16"	MATE / ANTID	6	19,80	0,96	10,33	72	69,12	744,00	1452,60
40 x 40	16" x 16"	PULIDO	6	17,40	0,96	10,33	72	69,12	744,00	1279,80
40 x 40	16" x 16"	ESP 14 MM MATE	4	20,60	0,64	6,89	72	46,08	496,00	1510,20
40 x 40	16" x 16"	ESP 14 MM PULIDO	4	18,80	0,64	6,89	72	46,08	496,00	1380,60
60 x 60	24" x 24"	MATE	4	33,20	1,44	15,50	32	46,08	496,00	1089,40
60 x 60	24" x 24"	PULIDO	4	30,40	1,44	15,50	32	46,08	496,00	999,80

PIEZAS COMPLEMENTARIAS≈ACCESSORIES≈ACCESSOIRES ET DECORATIONS≈FORMTEILE

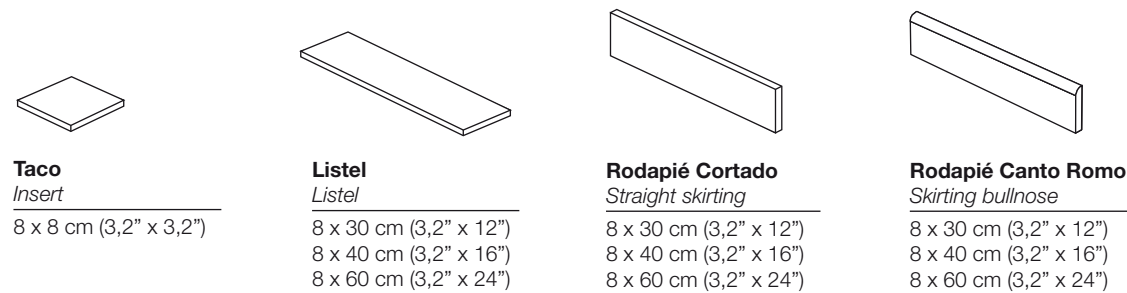

**Taco**  
*Insert*

8 x 8 cm (3,2" x 3,2")

**Listel**  
*Listel*

8 x 30 cm (3,2" x 12")  
8 x 40 cm (3,2" x 16")  
8 x 60 cm (3,2" x 24")

**Rodapié Cortado**  
*Straight skirting*

8 x 30 cm (3,2" x 12")  
8 x 40 cm (3,2" x 16")  
8 x 60 cm (3,2" x 24")

**Rodapié Canto Romo**  
*Skirting bullnose*

8 x 30 cm (3,2" x 12")  
8 x 40 cm (3,2" x 16")  
8 x 60 cm (3,2" x 24")

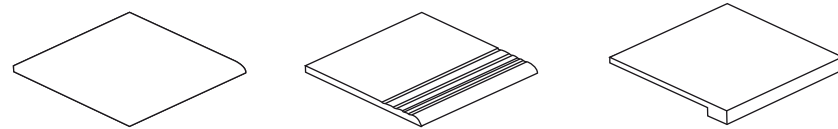

**Canto Romo**  
*Rounded edge piece*

30 x 30 cm (12" x 12")  
40 x 40 cm (16" x 16")  
60 x 60 cm (24" x 24")

**Peldaño Ranurado**  
*Grooved stair tread*

30 x 30 cm (12" x 12")  
40 x 40 cm (16" x 16")  
60 x 60 cm (24" x 24")

**Peldaño Elit con o sin ranura**  
*Grooved Elit Stair/Plain Elit Stair*

30 x 30 cm (12" x 12")  
40 x 40 cm (16" x 16")  
60 x 60 cm (24" x 24")



**Pie Escocia**  
*Cove stop-end*

R. Ext= 5

**Ángulo escocia**  
*Cove angle*

R. Int.= 3

**Escocia**  
*Cove*

L= 20 cm (8")

Estas piezas se fabrican exclusivamente en los modelos Mijares y Segre en acabado natural.  
Only for models Mijares and Segre in natural finish.  
Uniquement les modèles Mijares et Segre en naturel.  
Diese Stück werden nur mit den Modellen Mijares und Segre mit der Ausfertigung natur hergestellt.

≈ Ríos Segre 30x30 trafic.



PIEZAS COMPLEMENTARIAS≈ACCESSORIES≈ACCESSOIRES ET DECORATIONS≈FORMTEILE

**PACKING LIST**

PIEZAS ESPECIALES≈SPECIAL ACCESSORIES≈ÉLÉMENTS SPÉCIAUX≈SPEZIALTEILE

PIEZA/PIECE	CM	SIZE	ACABADO/ FINISH	PRECIO/ PRICE	ACABADO/ FINISH	PRECIO/ PRICE
Taco - Insert	8x8	3,2" x 3,2"	MATE / ANTID	P-02	PULIDO	P-02
Rodapié Cortado - Straight skirting	8x30	3,2" x 12"	TRAFIC	P-02		
Rodapié Cortado - Straight skirting	8x40	3,2" x 16"	MATE / ANTID	P-02	PULIDO	P-03
Rodapié Cortado - Straight skirting	8x60	3,2" x 24"	MATE / ANTID	P-04	PULIDO	P-05
Rodapié Canto Romo - Skirting bullnose	8x30	3,2" x 12"	TRAFIC	P-03		
Rodapié Canto Romo - Skirting bullnose	8x40	3,2" x 16"	MATE / ANTID	P-03	PULIDO	P-04
Rodapié Canto Romo - Skirting bullnose	8x60	3,2" x 24"	MATE / ANTID	P-05	PULIDO	P-06
Listel	8x30	3,2" x 12"	TRAFIC	P-02		
Listel	8x40	3,2" x 16"	MATE / ANTID	P-02	PULIDO	P-03
Listel	8x60	3,2" x 24"	MATE / ANTID	P-04	PULIDO	P-05
Canto Romo 1 lado - Rounded edge piece 1 side	30x30	12" x 12"	TRAFIC	P-08		
Canto Romo 1 lado - Rounded edge piece 1 side	40x40	16" x 16"	MATE / ANTID	P-10	PULIDO	P-12
Canto Romo 1 lado - Rounded edge piece 1 side	60x60	24" x 24"	MATE	P-28	PULIDO	P-30
Canto Romo 2 lados - Rounded edge piece 2 sides	30x30	12" x 12"	TRAFIC	P-11		
Canto Romo 2 lados - Rounded edge piece 2 sides	40x40	16" x 16"	MATE / ANTID	P-14	PULIDO	P-17
Canto Romo 2 lados - Rounded edge piece 2 sides	60x60	24" x 24"	MATE	P-36	PULIDO	P-37
Peldaño Ranurado - Grooved stair tread	30x30	12" x 12"	TRAFIC	P-08		
Peldaño Ranurado - Grooved stair tread	40x40	16" x 16"	MATE / ANTID	P-10	PULIDO	P-12
Peldaño Ranurado - Grooved stair tread	60x60	24" x 24"	MATE	P-28	PULIDO	P-30
Peldaño Ranurado Esquina - Grooved stair tread corner	30x30	12" x 12"	TRAFIC	P-11		
Peldaño Ranurado Esquina - Grooved stair tread corner	40x40	16" x 16"	MATE / ANTID	P-14	PULIDO	P-17
Peldaño Ranurado Esquina - Grooved stair tread corner	60x60	24" x 24"	MATE	P-36	PULIDO	P-37
Peldaño Elit - Elit step	30x30	12" x 12"	TRAFIC	P-23		
Peldaño Elit - Elit step	40x40	16" x 16"	MATE / ANTID	P-30	PULIDO	P-33
Peldaño Elit - Elit step	60x60	24" x 24"	MATE	P-59	PULIDO	P-61
Peldaño Elit Esquina - Elit step corner	30x30	12" x 12"	TRAFIC	P-42		
Peldaño Elit Esquina - Elit step corner	40x40	16" x 16"	MATE / ANTID	P-55	PULIDO	P-59
Peldaño Elit Esquina - Elit step corner	60x60	24" x 24"	MATE	P-101	PULIDO	P-103
Pie Escocia - Cove stop-end	R. Ext.= 5		NATURAL	P-07		
Ángulo escocia - Cove angle	R. Int.= 3		NATURAL	P-07		
Escocia - Cove	L= 20 cm	8"	NATURAL	P-07		

**ESPESORADO**

Taco - Insert - 12 / 14mm	8x8	3,2 x 3,2"	MATE	P-02	PULIDO	P-02
Rodapié Cortado - Straight skirting - 12mm	8x30	3,2 x 12"	MATE / ANTID	P-02	PULIDO	P-02
Rodapié Cortado - Straight skirting - 14mm	8x40	3,2 x 16"	MATE	P-03	PULIDO	P-03
Rodapié Canto Romo - Skirting bullnose - 12mm	8x30	3,2 x 12"	MATE / ANTID	P-03	PULIDO	P-03
Rodapié Canto Romo - Skirting bullnose - 14mm	8x40	3,2 x 16"	MATE	P-04	PULIDO	P-04
Listel - 12mm	8x30	3,2 x 12"	MATE / ANTID	P-02	PULIDO	P-02
Listel - 14mm	8x40	3,2 x 16"	MATE	P-03	PULIDO	P-03
Canto Romo 1 lado - Rounded edge piece 1 side - 12mm	30x30	12 x 12"	MATE / ANTID	P-08	PULIDO	P-08
Canto Romo 1 lado - Rounded edge piece 1 side - 14mm	40x40	16 x 16"	MATE	P-13	PULIDO	P-14
Canto Romo 2 lados - Rounded edge piece 2 sides - 12mm	30x30	12 x 12"	MATE / ANTID	P-11	PULIDO	P-11
Canto Romo 2 lados - Rounded edge piece 2 sides - 14mm	40x40	16 x 16"	MATE	P-18	PULIDO	P-19
Peldaño Ranurado - Grooved stair tread - 12mm	30x30	12 x 12"	MATE / ANTID	P-08	PULIDO	P-08
Peldaño Ranurado - Grooved stair tread - 14mm	40x40	16 x 16"	MATE	P-13	PULIDO	P-14
Peldaño Ranurado Esquina - Grooved stair tread corner - 12mm	30x30	12 x 12"	MATE / ANTID	P-11	PULIDO	P-11
Peldaño Ranurado Esquina - Grooved stair tread corner - 14mm	40x40	16 x 16"	MATE / ANTID	P-18	PULIDO	P-19
Peldaño Elit - Elit step - 12mm	30x30	12 x 12"	MATE / ANTID	P-23	PULIDO	P-23
Peldaño Elit - Elit step - 14mm	40x40	16 x 16"	MATE	P-34	PULIDO	P-35
Peldaño Elit Esquina - Elit step corner - 12mm	30x30	12 x 12"	MATE / ANTID	P-42	PULIDO	P-42
Peldaño Elit Esquina - Elit step corner - 14mm	40x40	16 x 16"	MATE	P-60	PULIDO	P-61

Estas piezas se venden por unidad, a excepción de los rodapiés que se venden en cajas de 10 uds. (espesorado: 8 uds/caja).  
These items are sold by pieces with the exception of the skirtings which are sold by boxes of 10 pieces each (special thickness 8 pcs/box).  
Unité de vente à la pièce, sauf les plinthes vendus à la boîte de 10 unités (Épaisseurs 8 pièce/boîte).  
Die Formteile sind pro Stück verkauft außer die Sockel, die pro Karton mit 10 Stück verkauft sind (Spezialdicke 8 Stück pro Karton).

≈ Táctil Snow Go & Stop 40x40 + Dolmen Gris 60x60 Esp. rústico.



**CARACTERÍSTICAS TÉCNICAS**  
TECHNICAL CHARACTERISTICS

FORMATOS≈SIZES

40 x 40 cm (16" x 16")



Consulte página 10≈See page 10≈  
Voir page 10≈Sehen Sie Seite 10

NORMA≈NORM

NORMA UNE-ENV 12633:2003  
- Táctil: Clase 3

MODELOS  
MODELS

LEMÓN

SNOW

BLACK

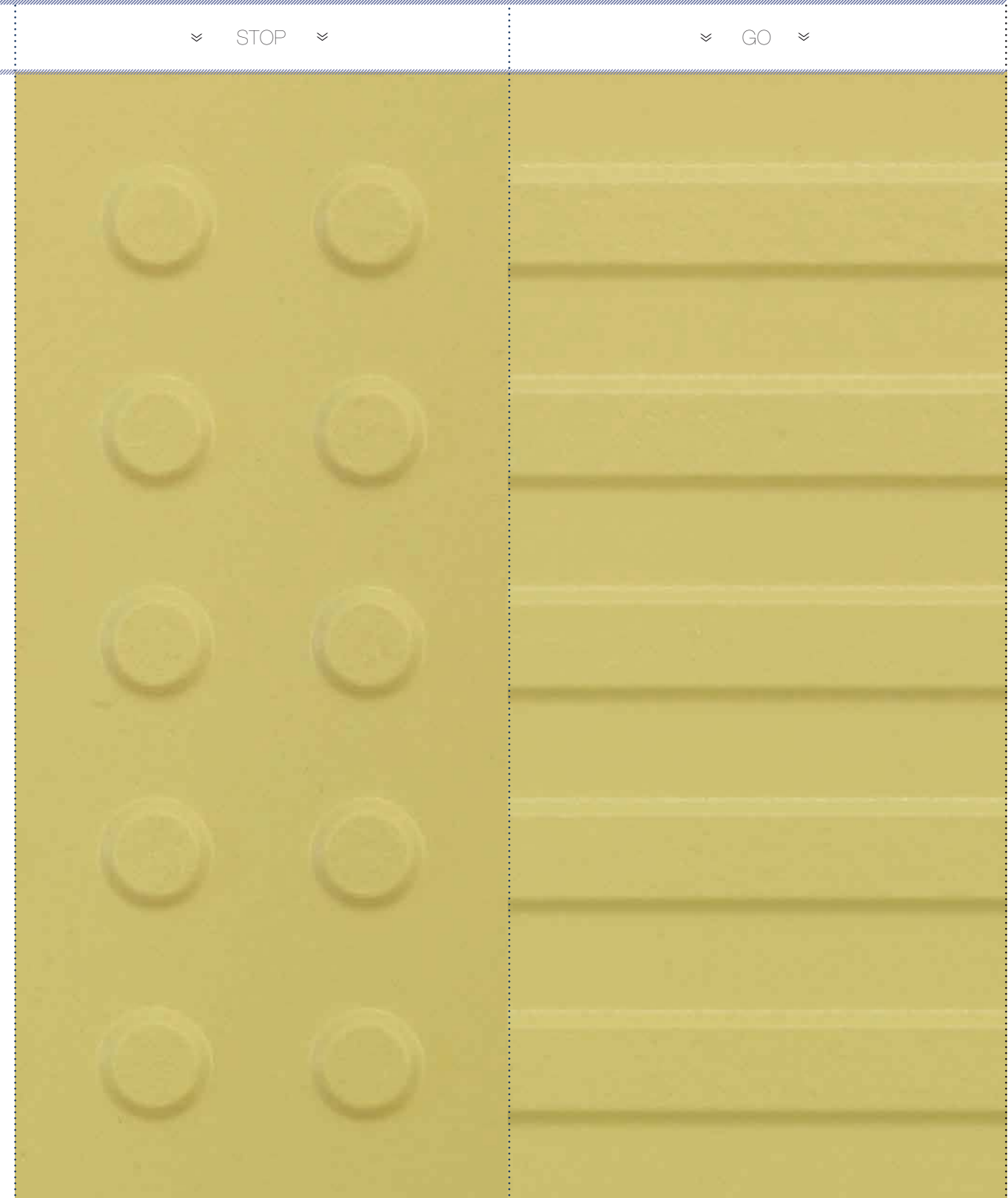
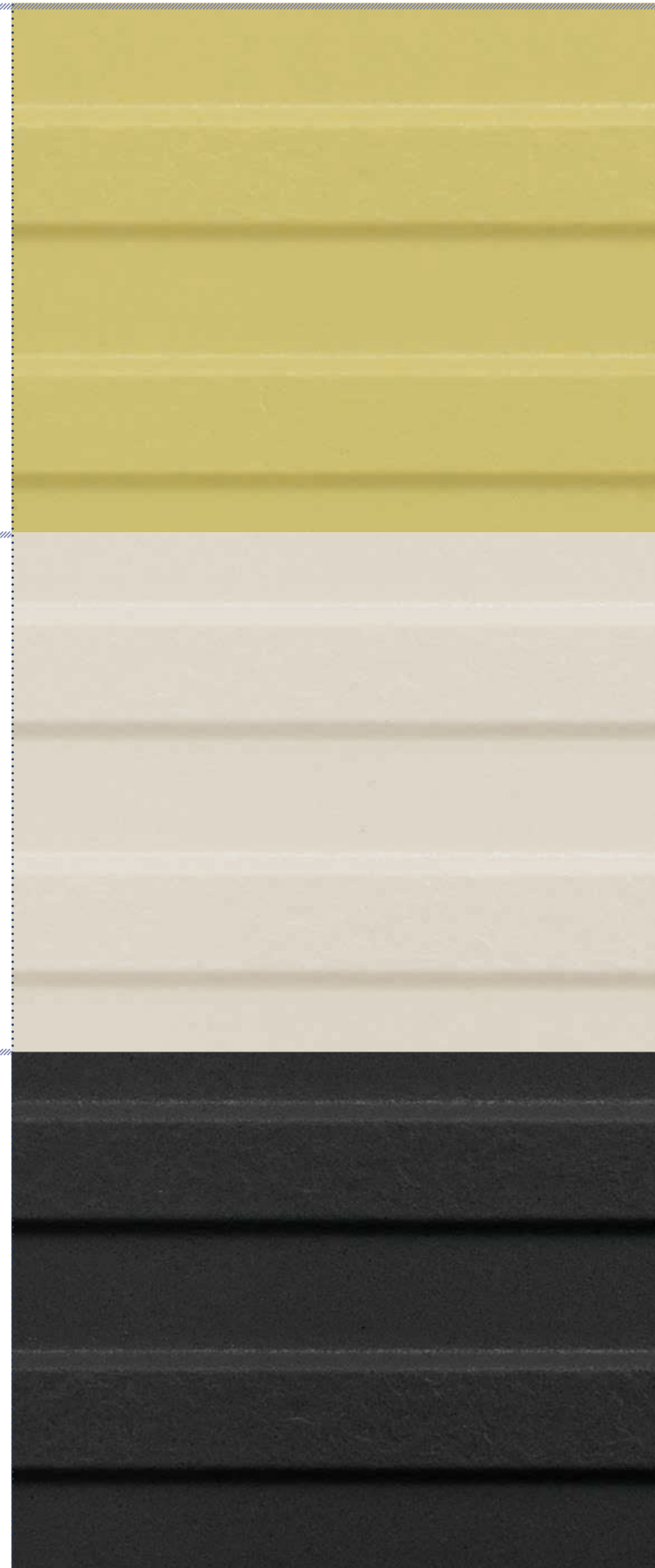

Detalle a escala 1:1 ≈ Detail scale 1:1 ≈ Detail échelle 1:1 ≈ Maßstab 1:1

	STOP	GO
LEMÓN	●	●
SNOW	●	●
BLACK	●	●

∞ Táctil Lemon Go & Stop 40x40 + Quarcity Gris 60x60 Esp. rústico.



≈ Táctil Snow Go & Stop 40x40 + Dolmen Grafito Esp. rústico.



## T56 LEMON ≈

40x40 cm. (16x16") · STOP

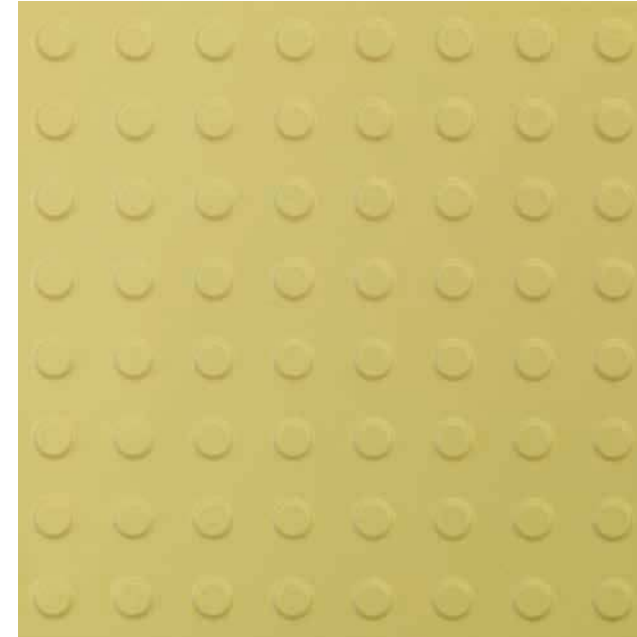

40x40 cm. (16x16") · GO

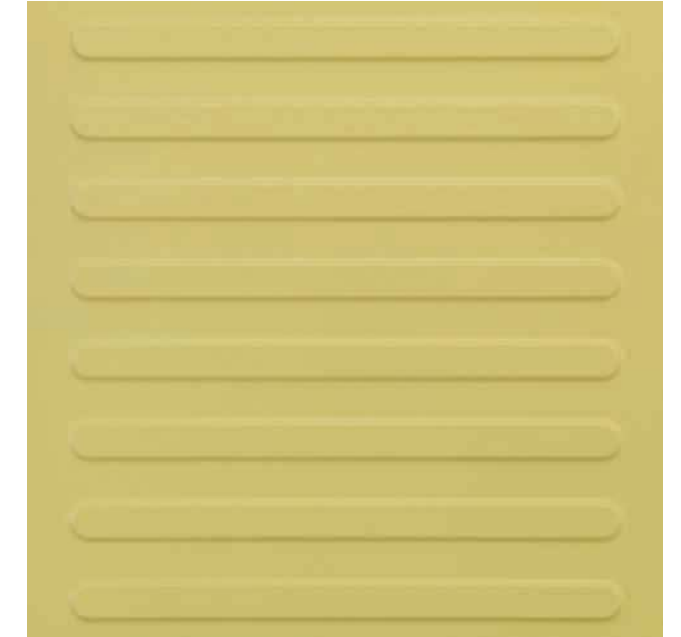

Stop B-128  
40 x 40 cm  
(16" x 16")



Go B-128  
40 x 40 cm  
(16" x 16")

### PACKING LIST

PIEZAS BASE≈BASIC TILES≈ELÉMENTS DE BASE≈GRUNDFLIESEN

CM	SIZE	ACABADO/FINISH	PIEZAS CAJA/ PIECES BOX	KG CAJA	M² CAJA	SQFT BOX	CAJAS/BOXES EUROPALET	M² EUROPALET	SQFT EUROPALET	KG EUROPALET
40 x 40	16" x 16"	TODOS	4	18	0,64	6,89	72	46,08	496,00	1.323



## T55 SNOW ≈

40x40 cm. (16x16") · STOP

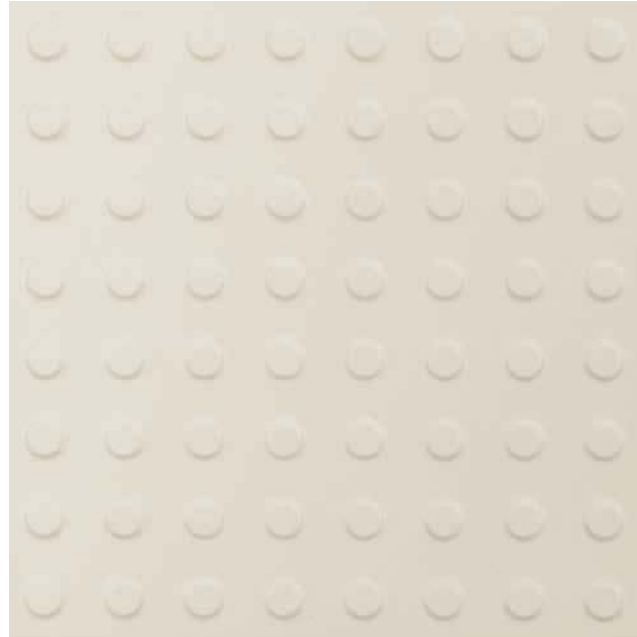

40x40 cm. (16x16") · GO



Stop B-92  
40 x 40 cm  
(16" x 16")



Go B-92  
40 x 40 cm  
(16" x 16")

## T59 BLACK ≈

40x40 cm. (16x16") · STOP

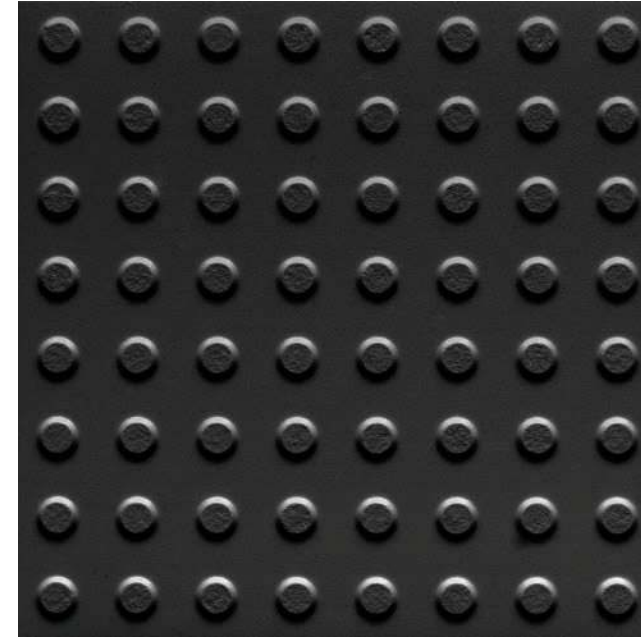

40x40 cm. (16x16") · GO



Stop B-92  
40 x 40 cm  
(16" x 16")



Go B-92  
40 x 40 cm  
(16" x 16")

### PACKING LIST

PIEZAS BASE≈BASIC TILES≈ELÉMENTS DE BASE≈GRUNDFLIESEN

CM	SIZE	ACABADO/FINISH	PIEZAS CAJA/ PIECES BOX	KG CAJA	M² CAJA	SQFT BOX	CAJAS/BOXES EUROPALET	M² EUROPALET	SQFT EUROPALLET	KG EUROPALET
40 x 40	16" x 16"	TODOS	4	18	0,64	6,89	72	46,08	496,00	1.323

### PACKING LIST

PIEZAS BASE≈BASIC TILES≈ELÉMENTS DE BASE≈GRUNDFLIESEN

CM	SIZE	ACABADO/FINISH	PIEZAS CAJA/ PIECES BOX	KG CAJA	M² CAJA	SQFT BOX	CAJAS/BOXES EUROPALET	M² EUROPALET	SQFT EUROPALLET	KG EUROPALET
40 x 40	16" x 16"	TODOS	4	18	0,64	6,89	72	46,08	496,00	1.323

≈ Técnica Cream 45x90 mate + Técnica Cream 45x90 rigatto + Mosaico 3,5x7,4 Técnica Cream.



## CARACTERÍSTICAS TÉCNICAS TECHNICAL CHARACTERISTICS

### FORMATOS≈SIZES

30 x 60 cm (12" x 24")  
22,5 x 90 cm (9" x 36")  
45 x 90 cm (18" x 36")  
60 x 60 cm (24" x 24")

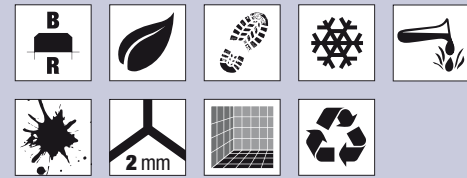

Consulte página 10≈See page 10≈  
Voir page 10≈Sehen Sie Seite 10

### ÁMBITOS DE USO≈AREA OF USE

#### PULIDO / MATE / RIGATTO

Idóneo para zonas interiores secas.  
*Suitable for dry indoor areas.*  
*Idéal pour application intérieure sèche.*  
*Ideal für trockene Innenräume.*

### NORMA≈NORM

NORMA UNE-ENV 12633:2003  
- Técnica Mate: Clase 1  
- Técnica Rigatto: Clase 1

NORMA DIN 51130  
- Técnica Mate: R - 10



FORMATO	MATE
60 x 60	U4 P4+ E3 C2

## MODELOS MODELS

BLUE

BLACK

COAL

SILVER

STEEL

SNOW

CREAM

AMBER

SAND

CINNAMON

≡ MATE ≡

≡ PULIDO ≡

≡ RIGATTO ≡

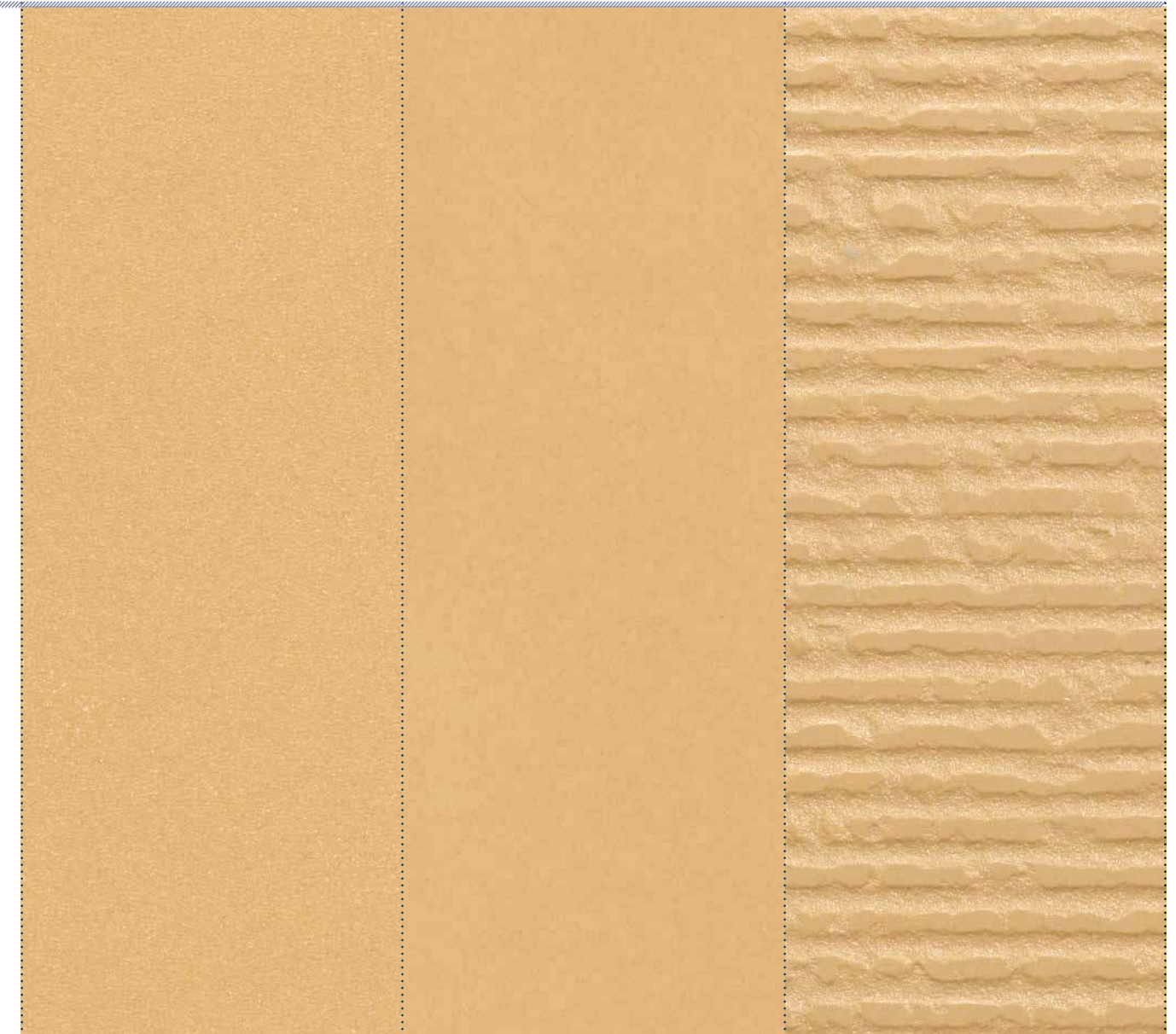

Detalle a escala 1:1 ≈ Detail scale 1:1 ≈ Detail échelle 1:1 ≈ Maßstab 1:1

	MATE	PULIDO	RIGATTO
BLUE	●	●	●
BLACK	●	●	●
COAL	●	●	●
SILVER	●	●	●
STEEL	●	●	●
SNOW	●	●	●
CREAM	●	●	●
AMBER	●	●	●
SAND	●	●	●
CINNAMON	●	●	●

≈ Técnica Coal 45x90 rigatto.



≈ Técnica Steel 30x60 pulido.



≈ Técnica Cream 45x90 mate + Mosaico 3,5x7,4 Técnica Cream.

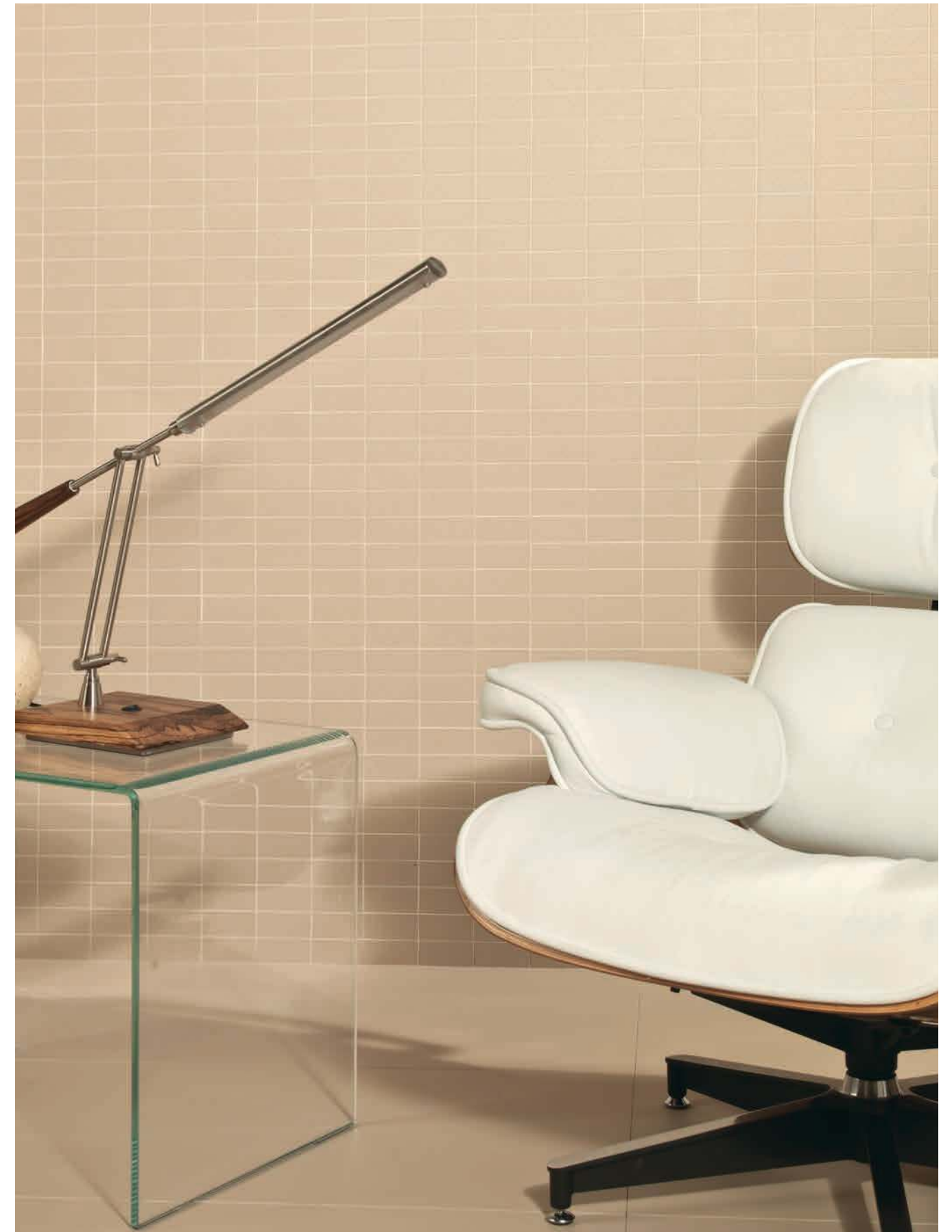

≈ Técnica Cream 45x90 mate + Técnica Cream 45x90 rigatto.



≈ Técnica Cream 45x90 rigatto.

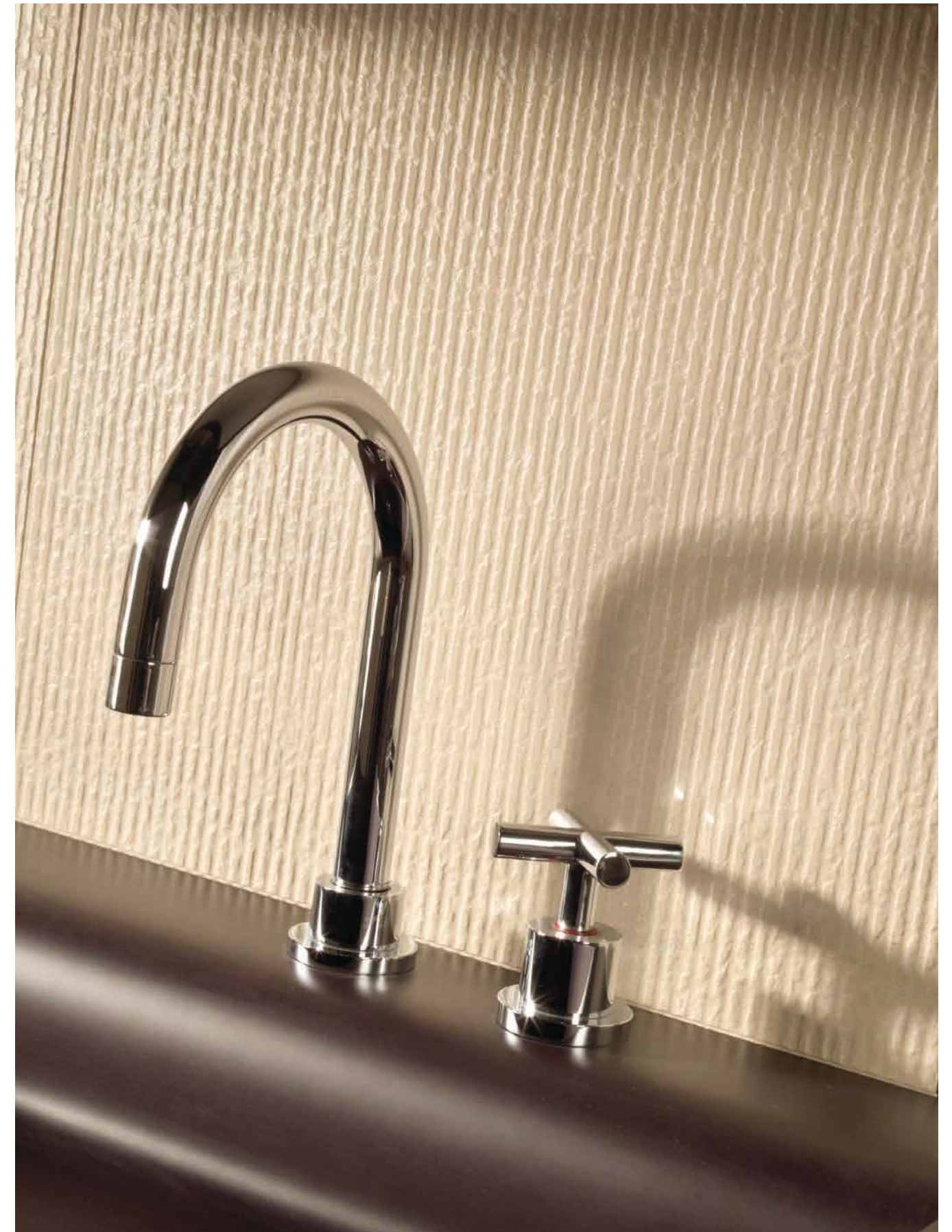

≈ Técnica Snow + Amber + Sand + Cinnamon 30x60 pulido.



≈ Técnica Black 45x90 mate + Mosaico 3,5x7,4 Técnica Black.



≈ Técnica Steel 45x90 rigatto.

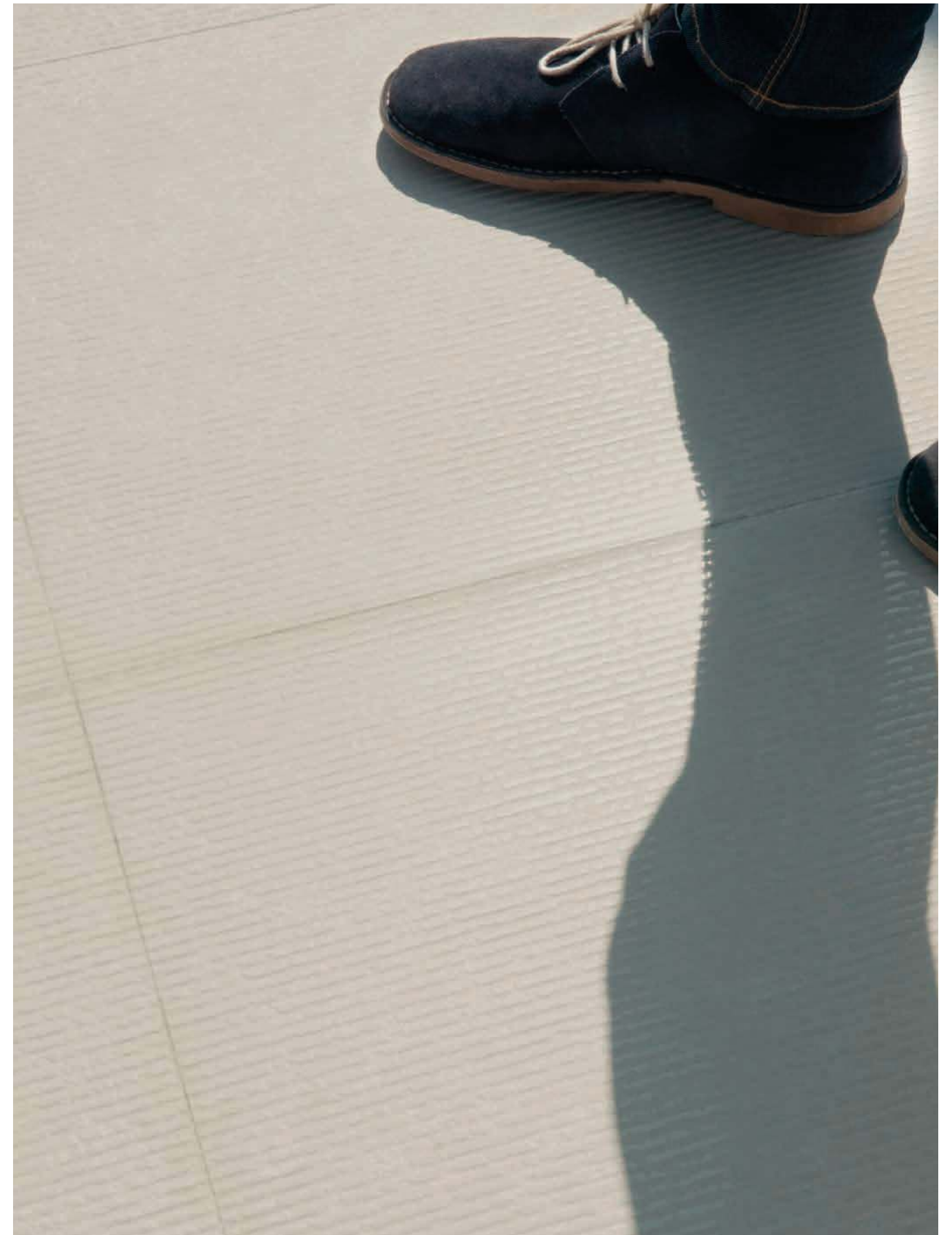



## T24 BLUE

30x60 cm. (12x24") · MATE

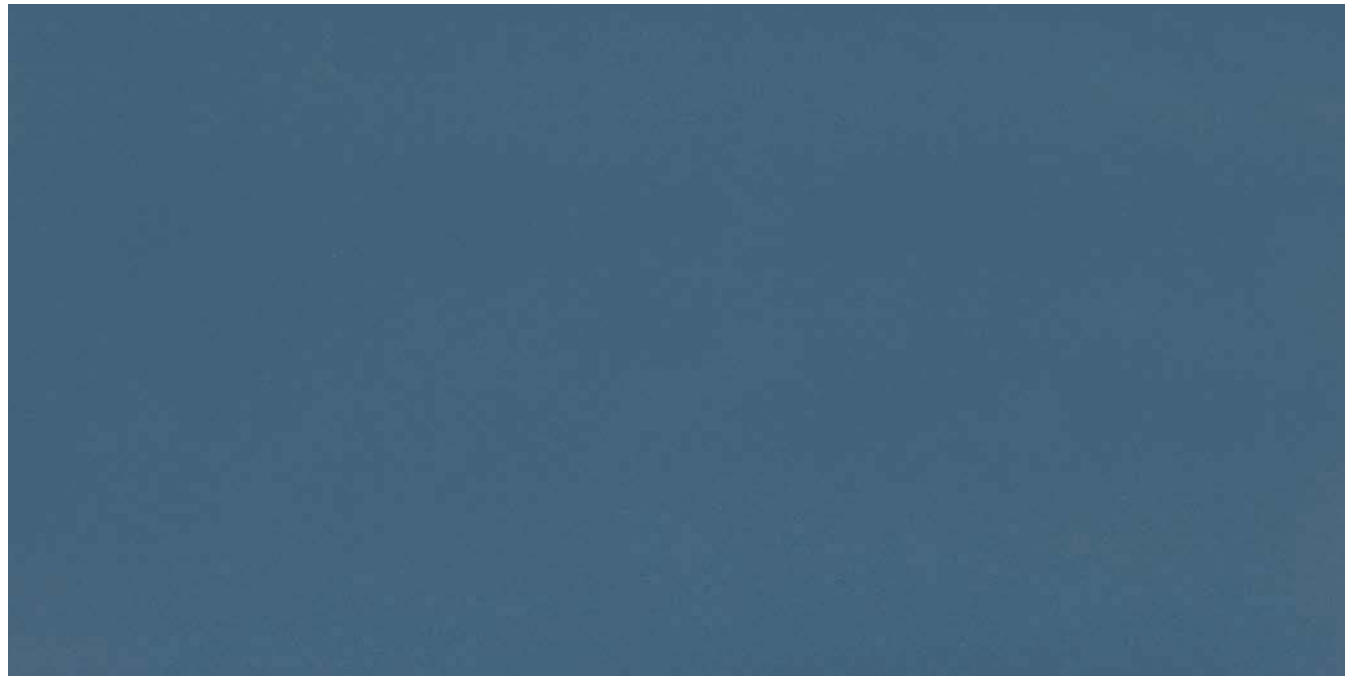

### ACABADOS / FINISHES

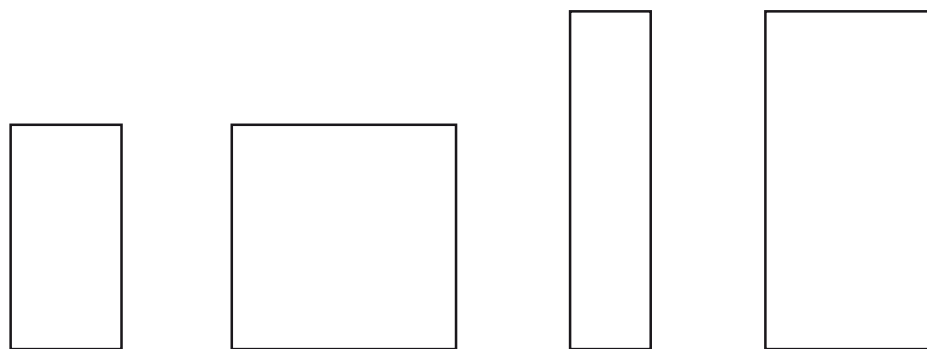

Mate B-80 Pulido B-92 30 x 60 cm (12" x 24")	Mate B-93 60 x 60 cm (24" x 24")	Rigatto B-121 22,5 x 90 cm (9" x 36")	Mate B-110 Rigatto B-116 45 x 90 cm (18" x 36")
---	--	---	--

### PACKING LIST

PIEZAS BASE≈BASIC TILES≈ELÉMENTS DE BASE≈GRUNDFLIESEN

CM	SIZE	ACABADO/FINISH	PIEZAS CAJA/ PIECES BOX	KG CAJA	M² CAJA	SQFT BOX	CAJAS/BOXES EUROPALET	M² EUROPALET	SQFT EUROPALLET	KG EUROPALET
30 x 60	12" x 24"	MATE	6	24,00	1,08	11,62	48	51,84	558,00	1179,00
30 x 60	12" x 24"	PULIDO	6	22,80	1,08	11,62	48	51,84	558,00	1121,40
60 x 60	24" x 24"	MATE	4	33,20	1,44	15,50	32	46,08	496,00	1089,40
22,5 x 90	9" x 36"	RIGATTO	4	20,40	0,81	8,72	42	34,02	366,19	883,80
45 x 90	18" x 36"	MATE / RIGATTO	2	20,50	0,81	8,72	39	31,59	340,03	826,50

## T19 BLACK



30x60 cm. (12x24") · MATE



### ACABADOS / FINISHES

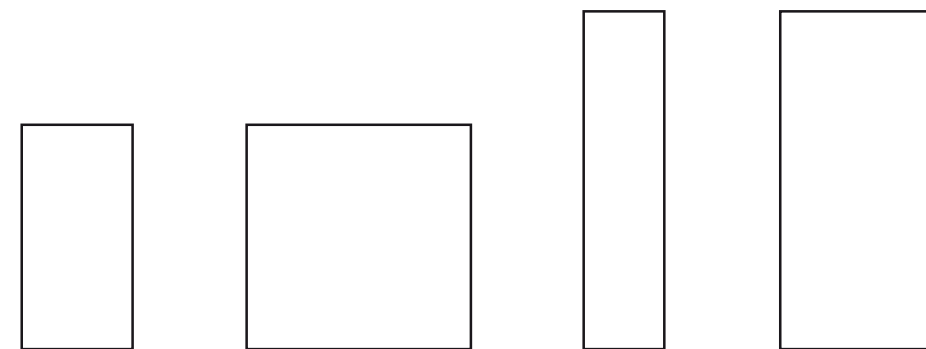

Mate B-57 Pulido B-65 30 x 60 cm (12" x 24")	Mate B-66 60 x 60 cm (24" x 24")	Rigatto B-80 22,5 x 90 cm (9" x 36")	Mate B-69 Rigatto B-75 45 x 90 cm (18" x 36")
---	--	--	--

### PACKING LIST

PIEZAS BASE≈BASIC TILES≈ELÉMENTS DE BASE≈GRUNDFLIESEN

CM	SIZE	ACABADO/FINISH	PIEZAS CAJA/ PIECES BOX	KG CAJA	M² CAJA	SQFT BOX	CAJAS/BOXES EUROPALET	M² EUROPALET	SQFT EUROPALLET	KG EUROPALET
30 x 60	12" x 24"	MATE	6	24,00	1,08	11,62	48	51,84	558,00	1179,00
30 x 60	12" x 24"	PULIDO	6	22,80	1,08	11,62	48	51,84	558,00	1121,40
60 x 60	24" x 24"	MATE	4	33,20	1,44	15,50	32	46,08	496,00	1089,40
22,5 x 90	9" x 36"	RIGATTO	4	20,40	0,81	8,72	42	34,02	366,19	883,80
45 x 90	18" x 36"	MATE / RIGATTO	2	20,50	0,81	8,72	39	31,59	340,03	826,50

## T14 COAL ≡

Reciclado

30x60 cm. (12x24") · MATE

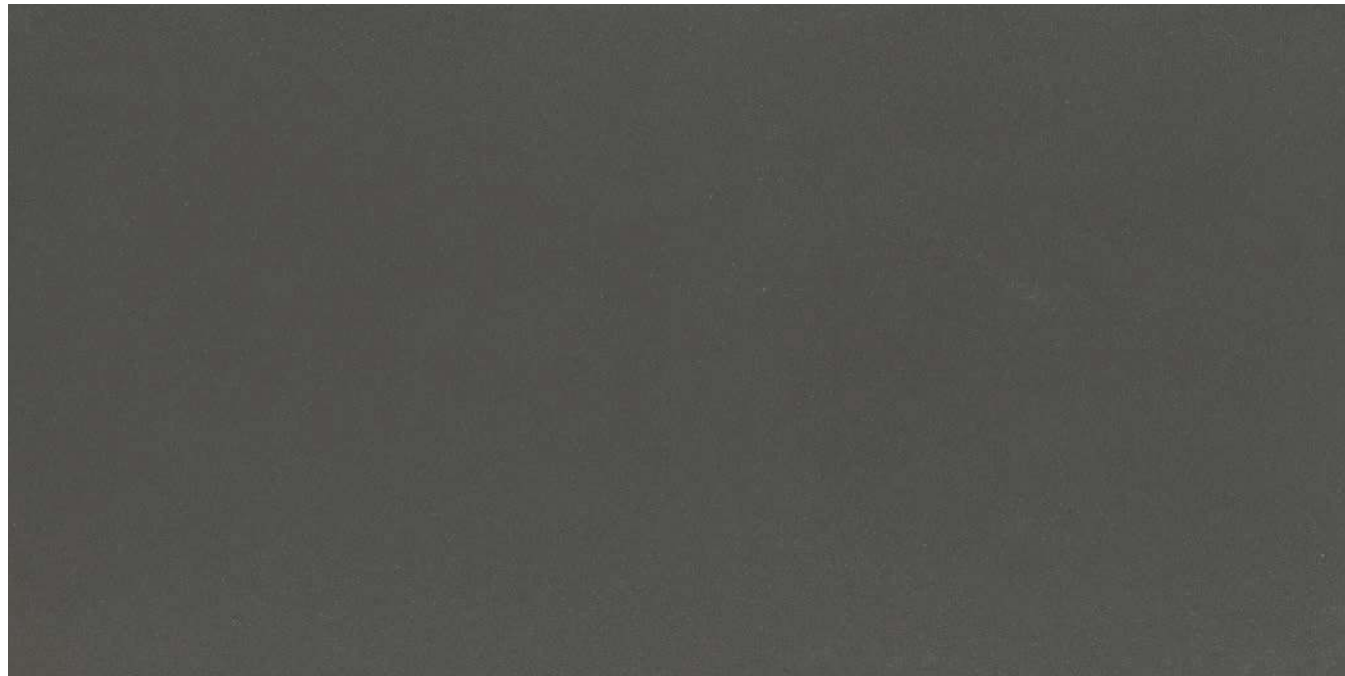

### ACABADOS / FINISHES

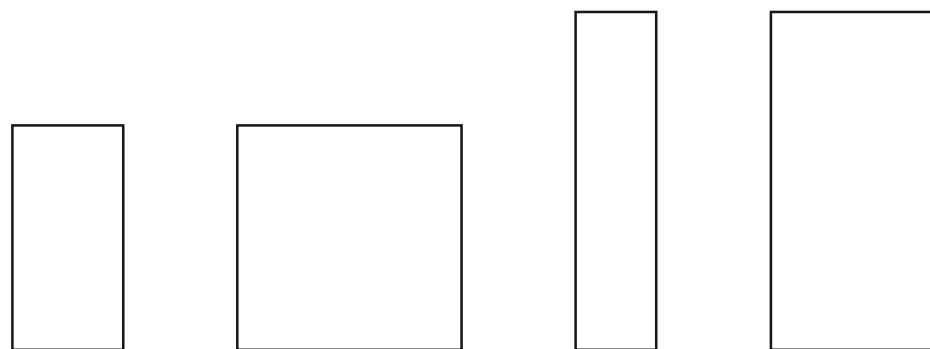

Mate B-57 Pulido B-65 30 x 60 cm (12" x 24")	Mate B-66 60 x 60 cm (24" x 24")	Rigatto B-80 22,5 x 90 cm (9" x 36")	Mate B-69 Rigatto B-75 45 x 90 cm (18" x 36")
---	--	--	--

### PACKING LIST

PIEZAS BASE≈BASIC TILES≈ELÉMENTS DE BASE≈GRUNDFLIESEN

CM	SIZE	ACABADO/FINISH	PIEZAS CAJA/ PIECES BOX	KG CAJA	M² CAJA	SQFT BOX	CAJAS/BOXES EUROPALET	M² EUROPALET	SQFT EUROPALET	KG EUROPALET
30 x 60	12" x 24"	MATE	6	24,00	1,08	11,62	48	51,84	558,00	1179,00
30 x 60	12" x 24"	PULIDO	6	22,80	1,08	11,62	48	51,84	558,00	1121,40
60 x 60	24" x 24"	MATE	4	33,20	1,44	15,50	32	46,08	496,00	1089,40
22,5 x 90	9" x 36"	RIGATTO	4	20,40	0,81	8,72	42	34,02	366,19	883,80
45 x 90	18" x 36"	MATE / RIGATTO	2	20,50	0,81	8,72	39	31,59	340,03	826,50

## T11 SILVER ≡

Reciclado

30x60 cm. (12x24") · MATE



### ACABADOS / FINISHES

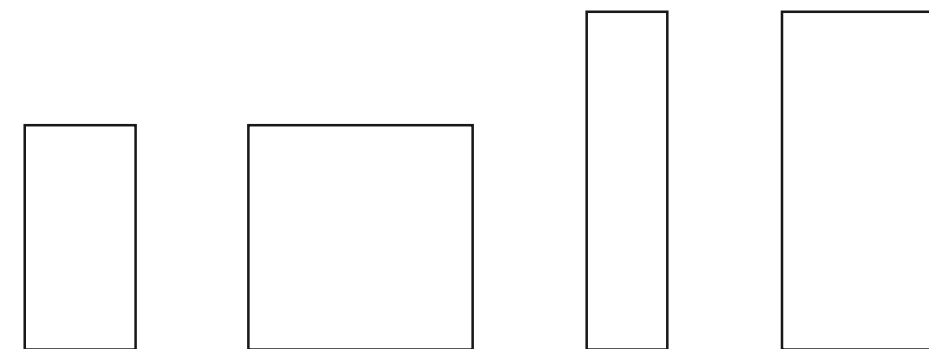

Mate B-57 Pulido B-65 30 x 60 cm (12" x 24")	Mate B-66 60 x 60 cm (24" x 24")	Rigatto B-80 22,5 x 90 cm (9" x 36")	Mate B-69 Rigatto B-75 45 x 90 cm (18" x 36")
---	--	--	--

### PACKING LIST

PIEZAS BASE≈BASIC TILES≈ELÉMENTS DE BASE≈GRUNDFLIESEN

CM	SIZE	ACABADO/FINISH	PIEZAS CAJA/ PIECES BOX	KG CAJA	M² CAJA	SQFT BOX	CAJAS/BOXES EUROPALET	M² EUROPALET	SQFT EUROPALET	KG EUROPALET
30 x 60	12" x 24"	MATE	6	24,00	1,08	11,62	48	51,84	558,00	1179,00
30 x 60	12" x 24"	PULIDO	6	22,80	1,08	11,62	48	51,84	558,00	1121,40
60 x 60	24" x 24"	MATE	4	33,20	1,44	15,50	32	46,08	496,00	1089,40
22,5 x 90	9" x 36"	RIGATTO	4	20,40	0,81	8,72	42	34,02	366,19	883,80
45 x 90	18" x 36"	MATE / RIGATTO	2	20,50	0,81	8,72	39	31,59	340,03	826,50

## T20 STEEL ≈

30x60 cm. (12x24") · MATE



### ACABADOS / FINISHES

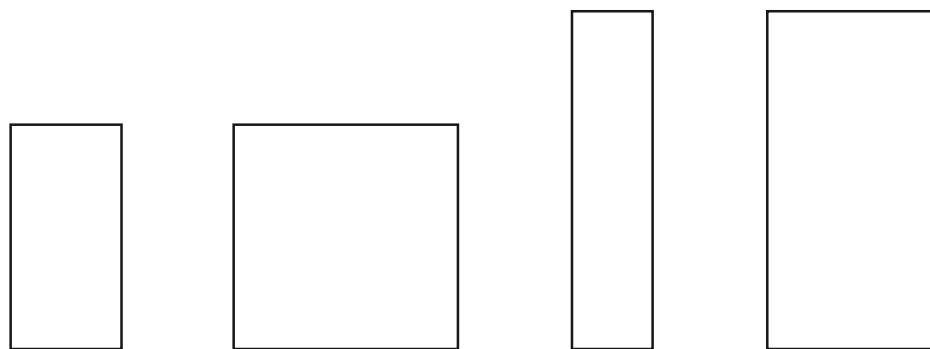

Mate B-57  
Pulido B-65  
30 x 60 cm  
(12" x 24")

Mate B-66  
60 x 60 cm  
(24" x 24")

Rigatto B-80  
22,5 x 90 cm  
(9" x 36")

Mate B-69  
Rigatto B-75  
45 x 90 cm  
(18" x 36")

### PACKING LIST

PIEZAS BASE≈BASIC TILES≈ELÉMENTS DE BASE≈GRUNDFLIESEN

CM	SIZE	ACABADO/FINISH	PIEZAS CAJA/ PIECES BOX	KG CAJA	M² CAJA	SQFT BOX	CAJAS/BOXES EUROPALET	M² EUROPALET	SQFT EUROPALLET	KG EUROPALET
30 x 60	12" x 24"	MATE	6	24,00	1,08	11,62	48	51,84	558,00	1179,00
30 x 60	12" x 24"	PULIDO	6	22,80	1,08	11,62	48	51,84	558,00	1121,40
60 x 60	24" x 24"	MATE	4	33,20	1,44	15,50	32	46,08	496,00	1089,40
22,5 x 90	9" x 36"	RIGATTO	4	20,40	0,81	8,72	42	34,02	366,19	883,80
45 x 90	18" x 36"	MATE / RIGATTO	2	20,50	0,81	8,72	39	31,59	340,03	826,50

## T15 SNOW ≈

30x60 cm. (12x24") · MATE

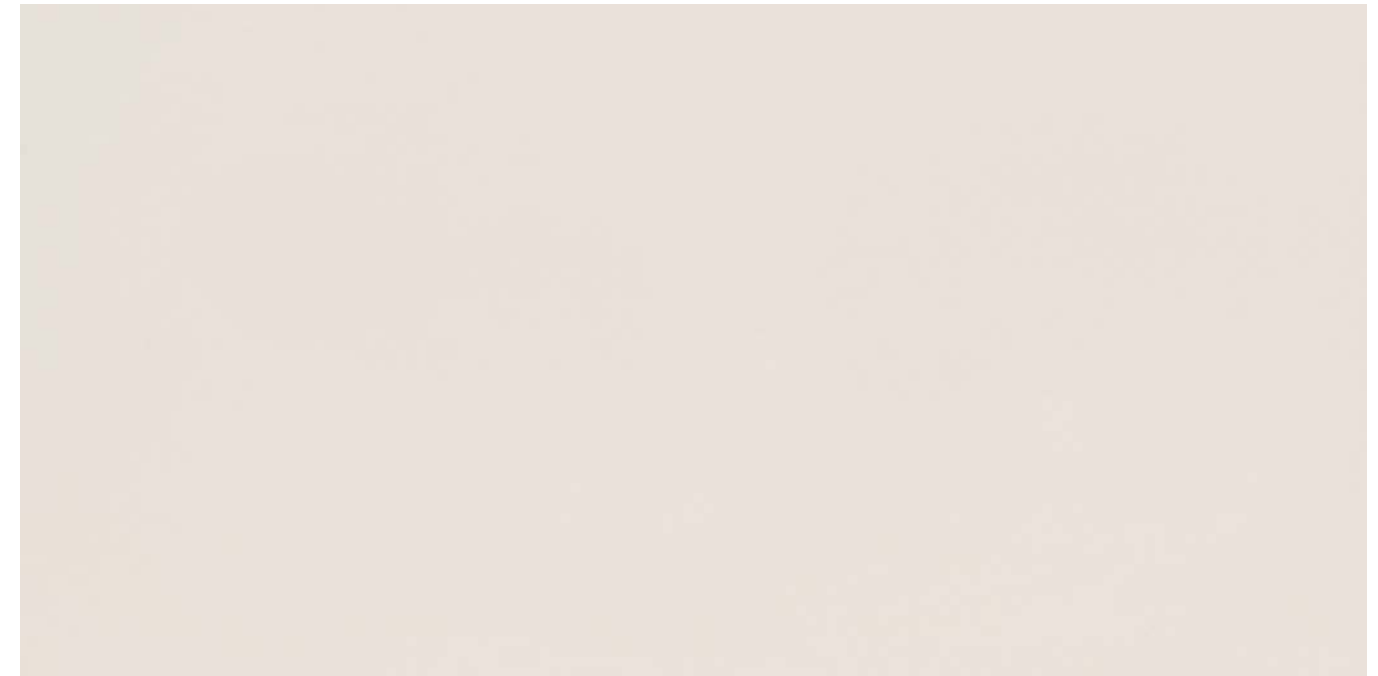

### ACABADOS / FINISHES

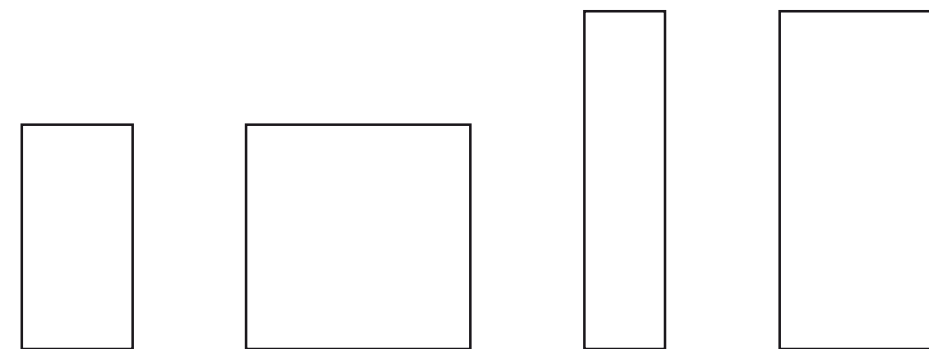

Mate B-57  
Pulido B-65  
30 x 60 cm  
(12" x 24")

Mate B-66  
60 x 60 cm  
(24" x 24")

Rigatto B-80  
22,5 x 90 cm  
(9" x 36")

Mate B-69  
Rigatto B-75  
45 x 90 cm  
(18" x 36")

### PACKING LIST

PIEZAS BASE≈BASIC TILES≈ELÉMENTS DE BASE≈GRUNDFLIESEN

CM	SIZE	ACABADO/FINISH	PIEZAS CAJA/ PIECES BOX	KG CAJA	M² CAJA	SQFT BOX	CAJAS/BOXES EUROPALET	M² EUROPALET	SQFT EUROPALLET	KG EUROPALET
30 x 60	12" x 24"	MATE	6	24,00	1,08	11,62	48	51,84	558,00	1179,00
30 x 60	12" x 24"	PULIDO	6	22,80	1,08	11,62	48	51,84	558,00	1121,40
60 x 60	24" x 24"	MATE	4	33,20	1,44	15,50	32	46,08	496,00	1089,40
22,5 x 90	9" x 36"	RIGATTO	4	20,40	0,81	8,72	42	34,02	366,19	883,80
45 x 90	18" x 36"	MATE / RIGATTO	2	20,50	0,81	8,72	39	31,59	340,03	826,50

## T12 CREAM ≈

30x60 cm. (12x24") · MATE



### ACABADOS / FINISHES

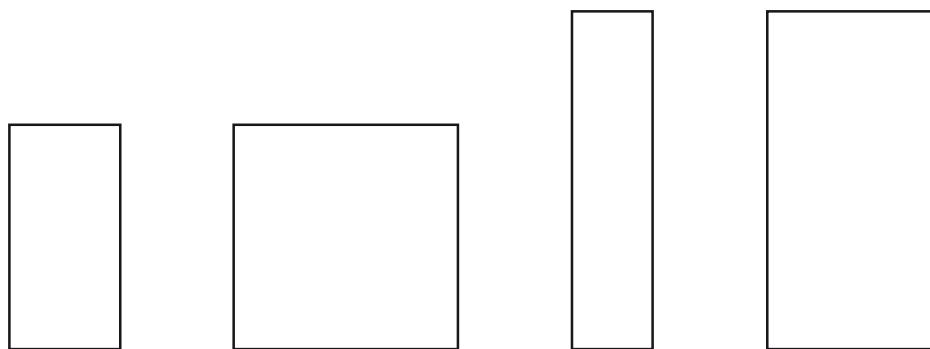

Mate B-57 Pulido B-65 30 x 60 cm (12" x 24")	Mate B-66 60 x 60 cm (24" x 24")	Rigatto B-80 22,5 x 90 cm (9" x 36")	Mate B-69 Rigatto B-75 45 x 90 cm (18" x 36")
---	--	--	--

### PACKING LIST

PIEZAS BASE≈BASIC TILES≈ELÉMENTS DE BASE≈GRUNDFLIESEN

CM	SIZE	ACABADO/FINISH	PIEZAS CAJA/ PIECES BOX	KG CAJA	M² CAJA	SQFT BOX	CAJAS/BOXES EUROPALET	M² EUROPALET	SQFT EUROPALET	KG EUROPALET
30 x 60	12" x 24"	MATE	6	24,00	1,08	11,62	48	51,84	558,00	1179,00
30 x 60	12" x 24"	PULIDO	6	22,80	1,08	11,62	48	51,84	558,00	1121,40
60 x 60	24" x 24"	MATE	4	33,20	1,44	15,50	32	46,08	496,00	1089,40
22,5 x 90	9" x 36"	RIGATTO	4	20,40	0,81	8,72	42	34,02	366,19	883,80
45 x 90	18" x 36"	MATE / RIGATTO	2	20,50	0,81	8,72	39	31,59	340,03	826,50

## T21 AMBER ≈

30x60 cm. (12x24") · MATE

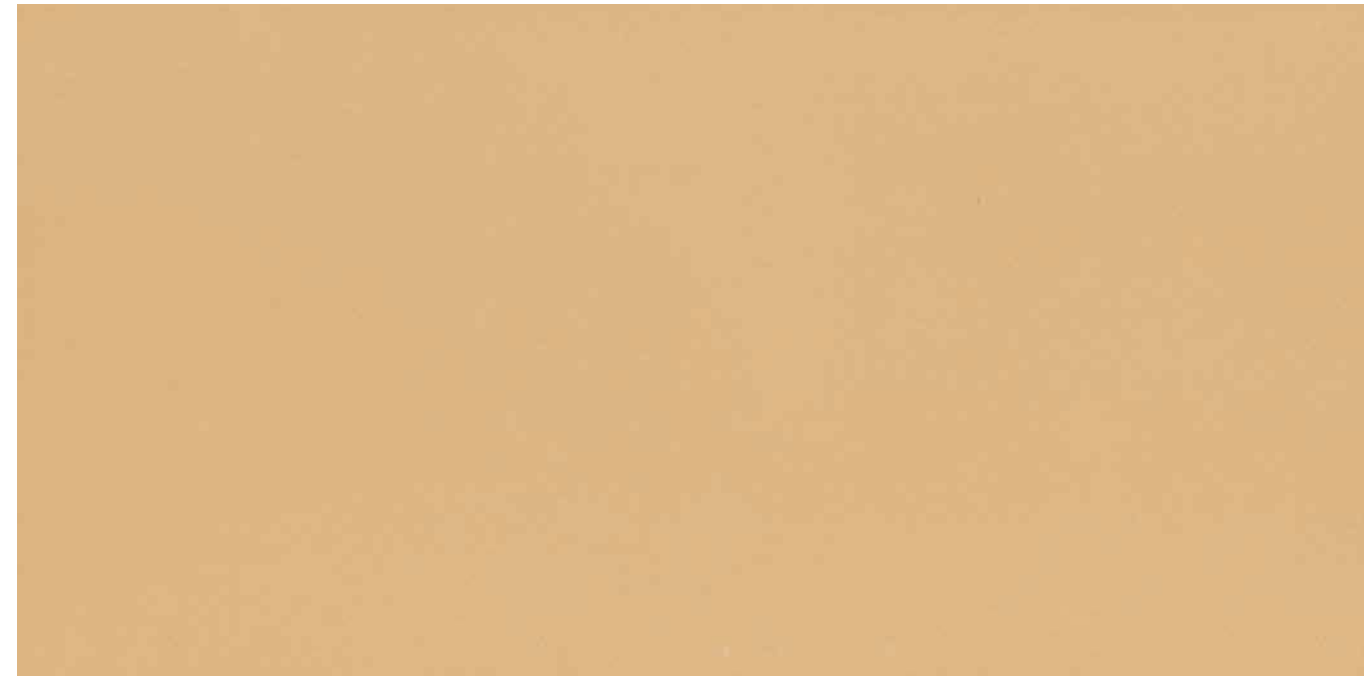

### ACABADOS / FINISHES

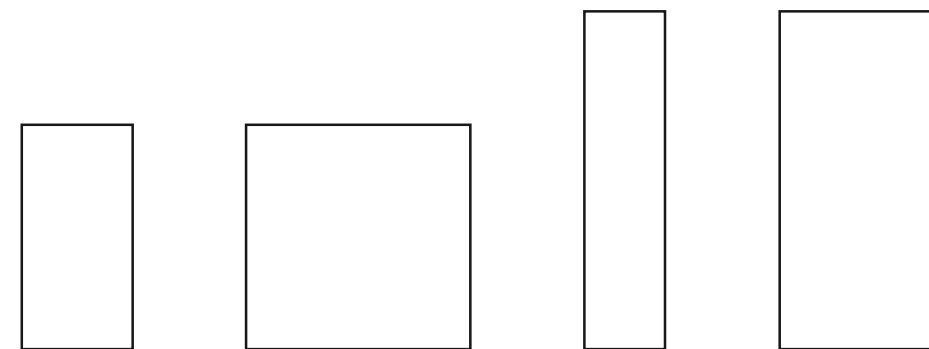

Mate B-69 Pulido B-77 30 x 60 cm (12" x 24")	Mate B-78 60 x 60 cm (24" x 24")	Rigatto B-92 22,5 x 90 cm (9" x 36")	Mate B-81 Rigatto B-87 45 x 90 cm (18" x 36")
---	--	--	--

### PACKING LIST

PIEZAS BASE≈BASIC TILES≈ELÉMENTS DE BASE≈GRUNDFLIESEN

CM	SIZE	ACABADO/FINISH	PIEZAS CAJA/ PIECES BOX	KG CAJA	M² CAJA	SQFT BOX	CAJAS/BOXES EUROPALET	M² EUROPALET	SQFT EUROPALET	KG EUROPALET
30 x 60	12" x 24"	MATE	6	24,00	1,08	11,62	48	51,84	558,00	1179,00
30 x 60	12" x 24"	PULIDO	6	22,80	1,08	11,62	48	51,84	558,00	1121,40
60 x 60	24" x 24"	MATE	4	33,20	1,44	15,50	32	46,08	496,00	1089,40
22,5 x 90	9" x 36"	RIGATTO	4	20,40	0,81	8,72	42	34,02	366,19	883,80
45 x 90	18" x 36"	MATE / RIGATTO	2	20,50	0,81	8,72	39	31,59	340,03	826,50

## T23 SAND ≈

30x60 cm. (12x24") · MATE



### ACABADOS / FINISHES

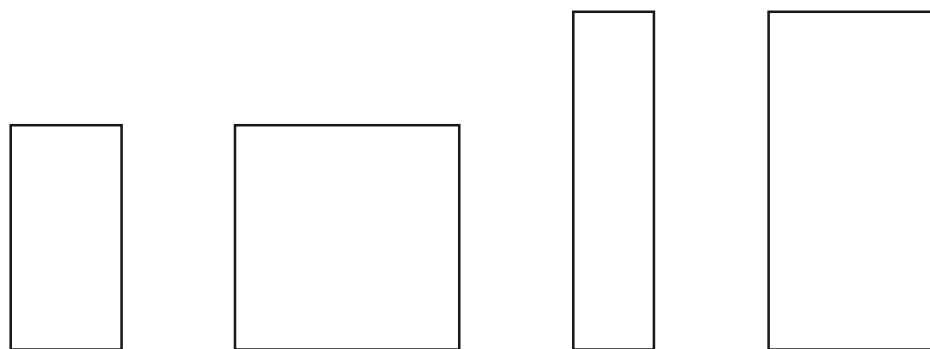

Mate B-57 Pulido B-65 30 x 60 cm (12" x 24")	Mate B-66 60 x 60 cm (24" x 24")	Rigatto B-80 22,5 x 90 cm (9" x 36")	Mate B-69 Rigatto B-75 45 x 90 cm (18" x 36")
---	--	--	--

### PACKING LIST

PIEZAS BASE≈BASIC TILES≈ELÉMENTS DE BASE≈GRUNDFLIESEN

CM	SIZE	ACABADO/FINISH	PIEZAS CAJA/ PIECES BOX	KG CAJA	M² CAJA	SQFT BOX	CAJAS/BOXES EUROPALET	M² EUROPALET	SQFT EUROPALLET	KG EUROPALET
30 x 60	12" x 24"	MATE	6	24,00	1,08	11,62	48	51,84	558,00	1179,00
30 x 60	12" x 24"	PULIDO	6	22,80	1,08	11,62	48	51,84	558,00	1121,40
60 x 60	24" x 24"	MATE	4	33,20	1,44	15,50	32	46,08	496,00	1089,40
22,5 x 90	9" x 36"	RIGATTO	4	20,40	0,81	8,72	42	34,02	366,19	883,80
45 x 90	18" x 36"	MATE / RIGATTO	2	20,50	0,81	8,72	39	31,59	340,03	826,50

## T22 CINNAMON ≈

30x60 cm. (12x24") · MATE

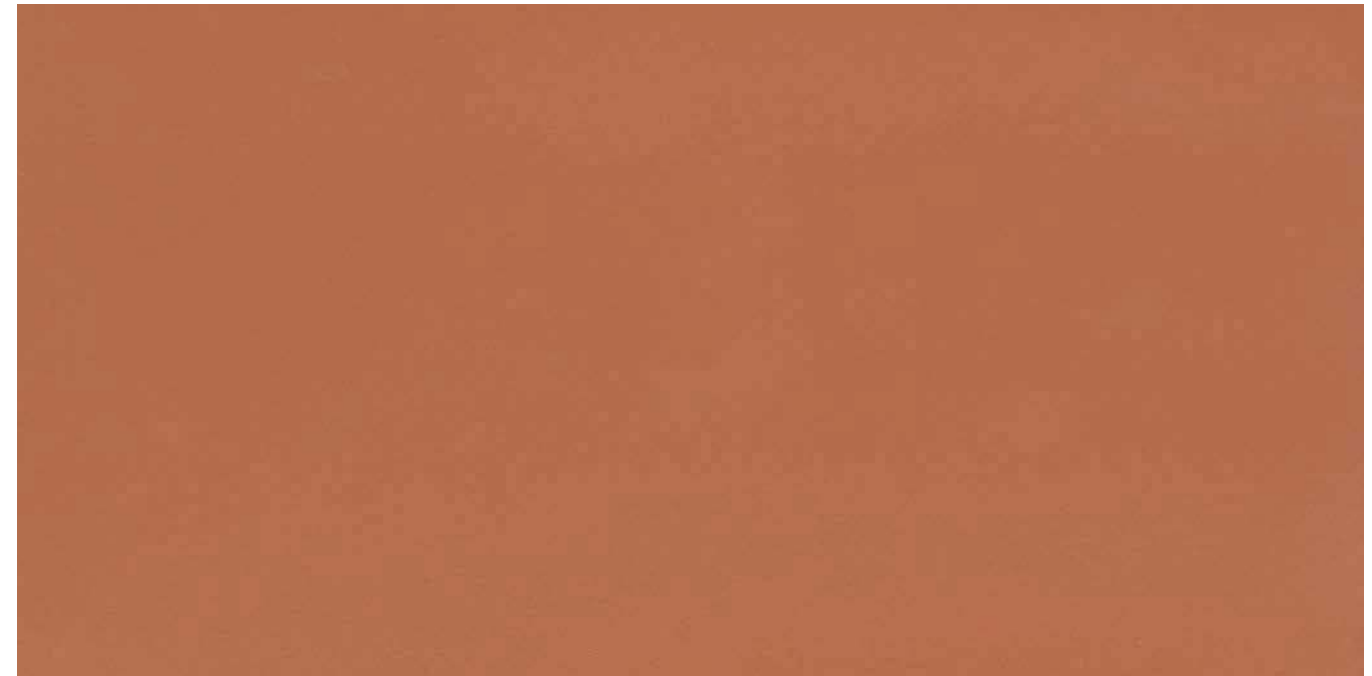

### ACABADOS / FINISHES

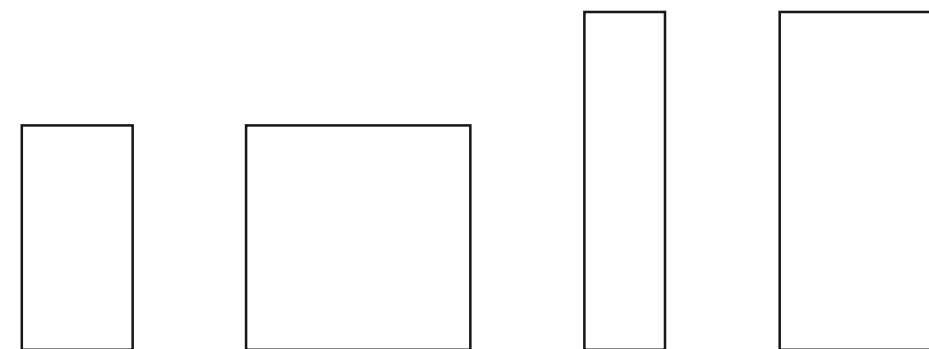

Mate B-80 Pulido B-92 30 x 60 cm (12" x 24")	Mate B-93 60 x 60 cm (24" x 24")	Rigatto B-121 22,5 x 90 cm (9" x 36")	Mate B-110 Rigatto B-116 45 x 90 cm (18" x 36")
---	--	---	--

### PACKING LIST

PIEZAS BASE≈BASIC TILES≈ELÉMENTS DE BASE≈GRUNDFLIESEN

CM	SIZE	ACABADO/FINISH	PIEZAS CAJA/ PIECES BOX	KG CAJA	M² CAJA	SQFT BOX	CAJAS/BOXES EUROPALET	M² EUROPALET	SQFT EUROPALLET	KG EUROPALET
30 x 60	12" x 24"	MATE	6	24,00	1,08	11,62	48	51,84	558,00	1179,00
30 x 60	12" x 24"	PULIDO	6	22,80	1,08	11,62	48	51,84	558,00	1121,40
60 x 60	24" x 24"	MATE	4	33,20	1,44	15,50	32	46,08	496,00	1089,40
22,5 x 90	9" x 36"	RIGATTO	4	20,40	0,81	8,72	42	34,02	366,19	883,80
45 x 90	18" x 36"	MATE / RIGATTO	2	20,50	0,81	8,72	39	31,59	340,03	826,50

## PIEZAS COMPLEMENTARIAS≈ACCESSORIES≈ACCESSOIRES ET DECORATIONS≈FORMTEILE

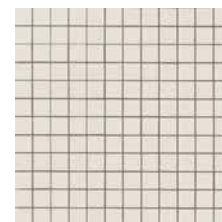

MOSAICO 2,3x2,3  
TÉCNICA SNOW  
30 x 30 cm (12" x 12")  
P-16

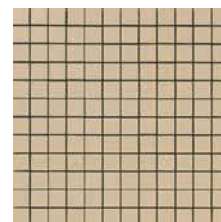

MOSAICO 2,3x2,3  
TÉCNICA CREAM  
30 x 30 cm (12" x 12")  
P-16

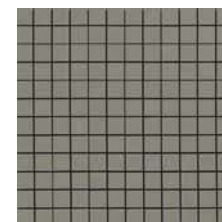

MOSAICO 2,3x2,3  
TÉCNICA SILVER  
30 x 30 cm (12" x 12")  
P-16

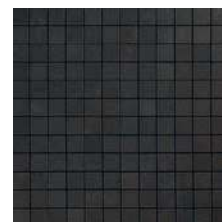

MOSAICO 2,3x2,3  
TÉCNICA BLACK  
30 x 30 cm (12" x 12")  
P-16

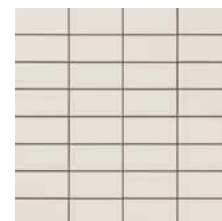

MOSAICO 3,5x7,4  
TÉCNICA SNOW  
30 x 30 cm (12" x 12")  
P-13

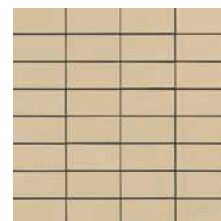

MOSAICO 3,5x7,4  
TÉCNICA CREAM  
30 x 30 cm (12" x 12")  
P-13

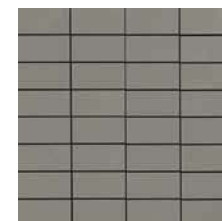

MOSAICO 3,5x7,4  
TÉCNICA SILVER  
30 x 30 cm (12" x 12")  
P-13

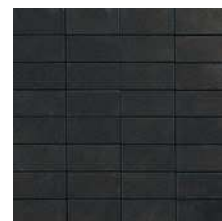

MOSAICO 3,5x7,4  
TÉCNICA BLACK  
30 x 30 cm (12" x 12")  
P-13

≈ Técnica Cinnamon 30x60 mate + Técnica Amber 30x60 mate.



## PIEZAS COMPLEMENTARIAS≈ACCESSORIES≈ACCESSOIRES ET DECORATIONS≈FORMTEILE

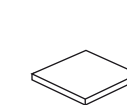

**Taco**  
*Insert*  
8 x 8 cm (3,2" x 3,2")

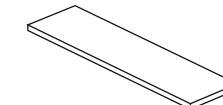

**Listel**  
*Listel*  
8 x 30 cm (3,2" x 12")  
8 x 45 cm (3,2" x 18")  
8 x 60 cm (3,2" x 24")  
8 x 90 cm (3,2" x 36")

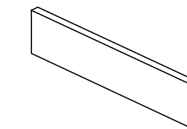

**Rodapié Cortado**  
*Straight skirting*  
8 x 30 cm (3,2" x 12")  
8 x 45 cm (3,2" x 18")  
8 x 60 cm (3,2" x 24")  
8 x 90 cm (3,2" x 36")

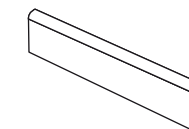

**Rodapié Canto Romo**  
*Skirting bullnose*  
8 x 30 cm (3,2" x 12")  
8 x 45 cm (3,2" x 18")  
8 x 60 cm (3,2" x 24")  
8 x 90 cm (3,2" x 36")

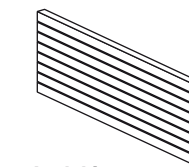

**Incisión**  
*Incision*  
30 x 60 cm (12" x 24")

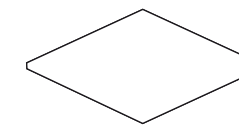

**Canto Romo**  
*Rounded edge piece*  
30 x 60 cm (12" x 24")  
45 x 90 cm (18" x 36")  
60 x 60 cm (24" x 24")

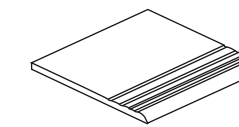

**Peldaño Ranurado**  
*Grooved stair tread*  
30 x 60 cm (12" x 24")  
45 x 90 cm (18" x 36")  
60 x 60 cm (24" x 24")

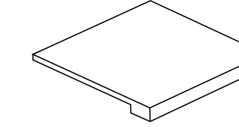

**Peldaño Elit con o sin ranura**  
*Grooved Elit Stair/Plain Elit Stair*  
30 x 60 cm (12" x 24")  
45 x 90 cm (18" x 36")  
60 x 60 cm (24" x 24")

### PACKING LIST

PIEZAS ESPECIALES≈SPECIAL ACCESSORIES≈ÉLÉMENTS SPÉCIAUX≈SPEZIALTEILE

PIEZA/PIECE	CM	SIZE	ACABADO/ FINISH	PRECIO/ PRICE	ACABADO/ FINISH	PRECIO/ PRICE
Taco - Insert	8x8	3,2" x 3,2"	MATE	P-02	PULIDO / RIGATTO	P-03
Rodapié Cortado - Straight skirting	8x30	3,2" x 12"	MATE	P-02	PULIDO	P-03
Rodapié Cortado - Straight skirting	8x45	3,2" x 18"	MATE	P-04	RIGATTO	P-04
Rodapié Cortado - Straight skirting	8x60	3,2" x 24"	MATE	P-05	PULIDO	P-05
Rodapié Cortado - Straight skirting	8x90	3,2" x 36"	MATE	P-10	PULIDO	P-10
Rodapié Canto Romo - Skirting bullnose	8x30	3,2" x 12"	MATE	P-03	PULIDO	P-03
Rodapié Canto Romo - Skirting bullnose	8x45	3,2" x 18"	MATE	P-05	RIGATTO	P-05
Rodapié Canto Romo - Skirting bullnose	8x60	3,2" x 24"	MATE	P-06	PULIDO	P-06
Rodapié Canto Romo - Skirting bullnose	8x90	3,2" x 36"	MATE	P-12	PULIDO	P-12
Listel	8x30	3,2" x 12"	MATE	P-02	PULIDO	P-03
Listel	8x45	3,2" x 18"	MATE	P-04	RIGATTO	P-04
Listel	8x60	3,2" x 24"	MATE	P-05	PULIDO	P-05
Listel	8x90	3,2" x 36"	MATE	P-10	PULIDO	P-10
Incisión	30x60	12" x 24"	MATE	P-14	PULIDO	P-16
Canto Romo 1 lado - Rounded edge piece 1 side	30x60	12" x 24"	MATE	P-18	PULIDO	P-19
Canto Romo 1 lado - Rounded edge piece 1 side	45x90	18" x 36"	MATE	P-38	RIGATTO	P-40
Canto Romo 1 lado - Rounded edge piece 1 side	60x60	24" x 24"	MATE	P-31		
Canto Romo 2 lados - Rounded edge piece 2 sides	30x60	12" x 24"	MATE	P-24	PULIDO	P-26
Canto Romo 2 lados - Rounded edge piece 2 sides	45x90	18" x 36"	MATE	P-49	RIGATTO	P-51
Canto Romo 2 lados - Rounded edge piece 2 sides	60x60	24" x 24"	MATE	P-39		
Peldaño Ranurado - Grooved stair tread	30x60	12" x 24"	MATE	P-18	PULIDO	P-19
Peldaño Ranurado - Grooved stair tread	45x90	18" x 36"	MATE	P-38	RIGATTO	P-40
Peldaño Ranurado - Grooved stair tread	60x60	24" x 24"	MATE	P-31		
Peldaño Ranurado Esquina - Grooved stair tread corner	30x60	12" x 24"	MATE	P-24	PULIDO	P-26
Peldaño Ranurado Esquina - Grooved stair tread corner	45x90	18" x 36"	MATE	P-49	RIGATTO	P-51
Peldaño Ranurado Esquina - Grooved stair tread corner	60x60	24" x 24"	MATE	P-39		
Peldaño Elit (lado 30) - Elit step (12" side)	30x60	12" x 24"	MATE	P-30	PULIDO	P-31
Peldaño Elit (lado 60) - Elit step (24" side)	30x60	12" x 24"	MATE	P-48	PULIDO	P-49
Peldaño Elit (lado 45) - Elit step (18" side)	45x90	18" x 36"	MATE	P-58	RIGATTO	P-60
Peldaño Elit (lado 90) - Elit step (36" side)	45x90	18" x 36"	MATE	P-84	RIGATTO	P-86
Peldaño Elit - Elit step	60x60	24" x 24"	MATE	P-62		
Peldaño Elit Esquina - Elit step corner	30x60	12" x 24"	MATE	P-69	PULIDO	P-70
Peldaño Elit Esquina - Elit step corner	45x90	18" x 36"	MATE	P-119	RIGATTO	P-121
Peldaño Elit Esquina - Elit step corner	60x60	24" x 24"	MATE	P-105		

Estas piezas se venden por unidad, a excepción de los rodapiés que se venden en cajas de 10 uds.  
These items are sold by pieces with the exception of the skirtings which are sold by boxes of 10 pieces each.  
Unité de vente à la pièce, sauf les plinthes vendus à la boîte de 10 unités.  
Die Formteile sind pro Stück verkauft außer die Sockel, die pro Karton mit 10 Stück verkauft sind.

≈ Dolmen Gris 60x60 Esp. rústico.



## Espesorado 20 mm

THICKNESS 20 mm ≈ ÉPAISSEUR 20 mm ≈ ÜBERSTÄRKE 20 mm

- 20 mm  **ESPESORADO**  
THICKNESS  
ÉPAISSEUR  
ÜBERSTÄRKE
-  **RECTIFICADO Y BISELADO**  
RECTIFIED AND BEVEL  
RECTIFIÉ ET BISEAUTÉ  
REKTIFIZIERT U. GEFASST
-  **RESISTENTE A LAS HELADAS**  
FROST RESISTANCE  
RÉSISTANCE AU GEL  
FROSTSICHER
- ≥ 12.600  **CARGA DE RUPTURA**  
BREAKING STRENGTH  
CHARGE DE RUPTURE  
BRUCHFEST
-  **RESISTENTE A LAS MANCHAS**  
STAIN RESISTANT  
RÉSISTANT AUX TÂCHES  
FLECKENRESISTENT
- Clase 3 **ANTI-SLIP**  
Grupo C **ANTI-SLIP**  
R - 12  **ANTIDESLIZANTE**  
ANTI-SLIP  
ANTIDÉRAPANT  
RUTSCHFEST
-  **DESTONIFICACIÓN INTENCIONADA**  
INTENTIONALLY NON-HOMOGENEOUS COLOUR  
DES VARIATION DE NUANCES INTENTIONNÉES  
DESIGNGEMÄSSE ENTFÄRBUNG
-  **RESISTENCIA DE LOS COLORES A LA LUZ**  
COLOUR RESISTANCE TO LIGHT  
RÉSISTANCE DES COULEURS À LA LUMIÈRE  
DER WIDERSTAND DER FARBE ANS LICHT

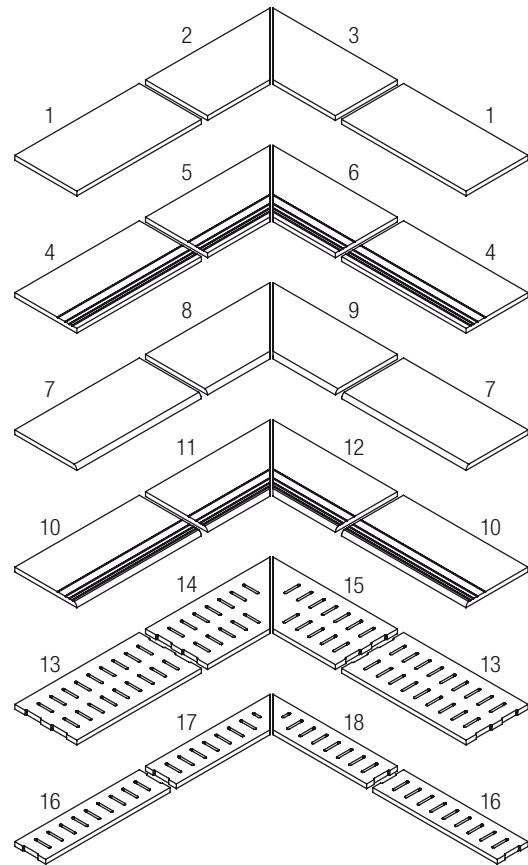

- 1- Peldaño Recto - Rectified step edge
- 2- Ángulo izquierdo Peldaño Recto - Rectified left mitred corner
- 3- Ángulo derecho Peldaño Recto - Rectified right mitred corner
- 4- Peldaño Recto Ranurado - Grooved step edge
- 5- Ángulo izquierdo Peldaño Recto Ranurado - Grooved left mitred corner
- 6- Ángulo derecho Peldaño Recto Ranurado - Grooved right mitred corner
- 7- Peldaño Canto Romo - Round edge
- 8- Ángulo izquierdo Peldaño Canto Romo - Right mitred round edge
- 9- Ángulo derecho Peldaño Canto Romo - Left mitred round edge
- 10- Peldaño Canto Romo Ranurado - Grooved stair tread
- 11- Ángulo izquierdo Peldaño Canto Romo Ranurado - Left mitred grooved stair tread
- 12- Ángulo derecho Peldaño Canto Romo Ranurado - Right mitred grooved stair tread
- 13- Rejilla - Grating
- 14- Ángulo izquierdo Rejilla - Left mitred grating
- 15- Ángulo derecho Rejilla - Right mitred grating
- 16- Rejilla - Grating
- 17- Ángulo izquierdo Rejilla - Left mitred grating
- 18- Ángulo derecho Rejilla - Right mitred grating

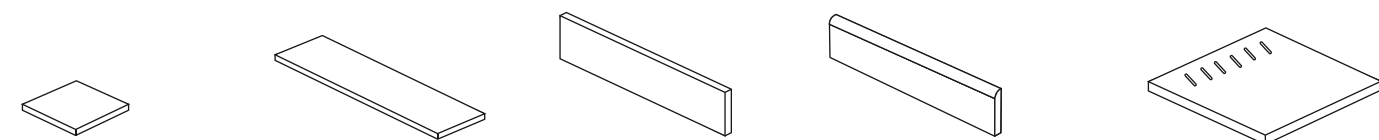

- |  |  |   |  |  |
|--|--|---|--|--|
| <p><b>Taco</b><br/>Insert<br/>Cabochon<br/>Einleger<br/>8 x 8 cm (3,2" x 3,2")</p> | <p><b>Listel</b><br/>Listel<br/>Listel<br/>Listelo<br/>8 x 45 cm (3,2" x 18")<br/>8 x 60 cm (3,2" x 24")</p> | <p><b>Rodapié Cortado</b><br/>Straight skirting<br/>Plinthe à bord droit<br/>Sockel geschnitten<br/>8 x 45 cm (3,2" x 18")<br/>8 x 60 cm (3,2" x 24")</p> | <p><b>Rodapié Canto Romo</b><br/>Skirting bullnose<br/>Plinthe à bord arrondie<br/>Sockel mit aufgerundete kante<br/>8 x 45 cm (3,2" x 18")<br/>8 x 60 cm (3,2" x 24")</p> | <p><b>Rejilla</b><br/>Grating<br/>Grille<br/>Raster<br/>60 x 60 cm (24" x 24")</p> |
|--|--|---|--|--|

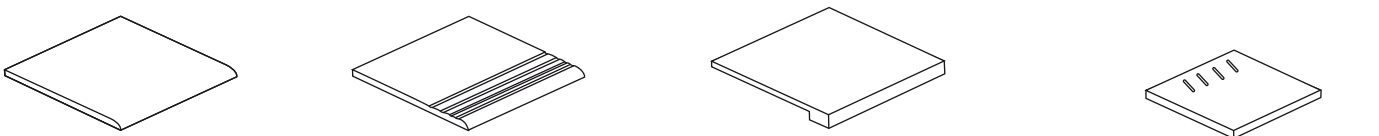

- |   |  |  |  |
|---|--|--|--|
| <p><b>Pieza con Canto Romo</b><br/>Rounded edge piece<br/>Pièce avec bord arrondie<br/>Stück mit aufgerundete kante<br/>45 x 45 cm (18" x 18")<br/>60 x 60 cm (24" x 24")</p> | <p><b>Peldaño Ranurado</b><br/>Grooved stair tread<br/>Nez de marche rainurée<br/>Stufe mit aufgerundete kante<br/>45 x 45 cm (18" x 18")<br/>60 x 60 cm (24" x 24")</p> | <p><b>Peldaño Elit con o sin ranura</b><br/>Grooved Elit Stair/Plain Elit Stair<br/>Nez de marche Elit avec ou sans rainure<br/>Integralstufe mit oder ohne rillen<br/>45 x 45 cm (18" x 18")<br/>60 x 60 cm (24" x 24")</p> | <p><b>Rejilla</b><br/>Grating<br/>Grille<br/>Raster<br/>45 x 45 cm (18" x 18")</p> |
|---|--|--|--|

## Opciones de colocación

LAYING SYSTEMS ≈ SYSTÈMES DE POSE ≈ VERLEGUNGSARTEN



**Colocación tradicional**  
Standard laying  
Pose traditionnelle  
Herkömmliche Verlegungsart



**Sobre césped**  
Laying on grass  
Pose sur pelouse  
Verlegung auf Wiese



**Sobre arena o grava**  
Laying on sand / gravel  
Pose sur sable ou sur gravier  
Verlegung auf Kies-oder Sand-Bett





















**Pavimento elevado**  
Raised Flooring System  
Pose surélevée  
Verlegung auf Stelzlagern



# XTREME 2.0

PORCELÁNICO~PORCELAIN TILE~GRÉS CÉRAME~FEINSTEINZEUG

<b>CARACTERÍSTICAS TÉCNICAS</b> <b>TECHNICAL CHARACTERISTICS</b>	<b>MODELOS</b> <b>MODELS</b>		<b>MODELOS</b> <b>MODELS</b>		<b>MODELOS</b> <b>MODELS</b>	
<p><b>FORMATOS~SIZES</b></p> <p>45 x 45 cm (18" x 18") Esp. 60 x 60 cm (24" x 24") Esp.</p>  <p>Consulte página 10~See page 10~ Voir page 10~Sehen Sie Seite 10</p> <p><b>ÁMBITOS DE USO~AREA OF USE</b></p> <p><b>ANTI - SLIP</b> 45°</p> <p>Idóneo para exteriores y piscinas. <i>Suitable for outdoor areas and swimming pools.</i> Idéal pour application extérieurs et piscines. <i>Ideal für außen und in Schwimmbädern.</i></p> <p><b>NORMA~NORM</b></p> <p>NORMA UNE-ENV 12633:2003 - Clase 3</p> <p>NORMA DIN 51130 - R - 12</p> <p>NORMA DIN 51097 (Pie descalzo) - Grupo C</p>	<p>≡ IRONWOOD ABETO</p> <hr/> <p>≡ IRONWOOD FRESNO</p> <hr/> <p>≡ IRONWOOD BAMBÚ</p> <hr/> <p>≡ IRONWOOD OLIVO</p> <hr/> <p>≡ IRONWOOD CIPRÉS</p> <hr/> <p>≡ IRONWOOD ÉBANO</p>	     	<p>≡ DOLMEN NACAR</p> <hr/> <p>≡ DOLMEN GRIS</p> <hr/> <p>≡ QUARCITY BEIGE</p> <hr/> <p>≡ QUARCITY GRAFITO</p> <hr/> <p>≡ QUANTUM BEIGE</p> <hr/> <p>≡ QUANTUM GRAFITO</p>	     	<p>≡ DOLMEN BEIGE</p> <hr/> <p>≡ DOLMEN GRAFITO</p> <hr/> <p>≡ QUARCITY GRIS</p> <hr/> <p>≡ QUARCITY NEGRO</p> <hr/> <p>≡ QUANTUM GRIS</p>	    

# XTREME 2.0

PORCELÁNICO~PORCELAIN TILE~GRÉS CÉRAME~FEINSTEINZEUG

≈ Quarcity Beige 60x60 Esp. rústico.



≈ Quarcity Grafito 60x60 Esp. rústico.

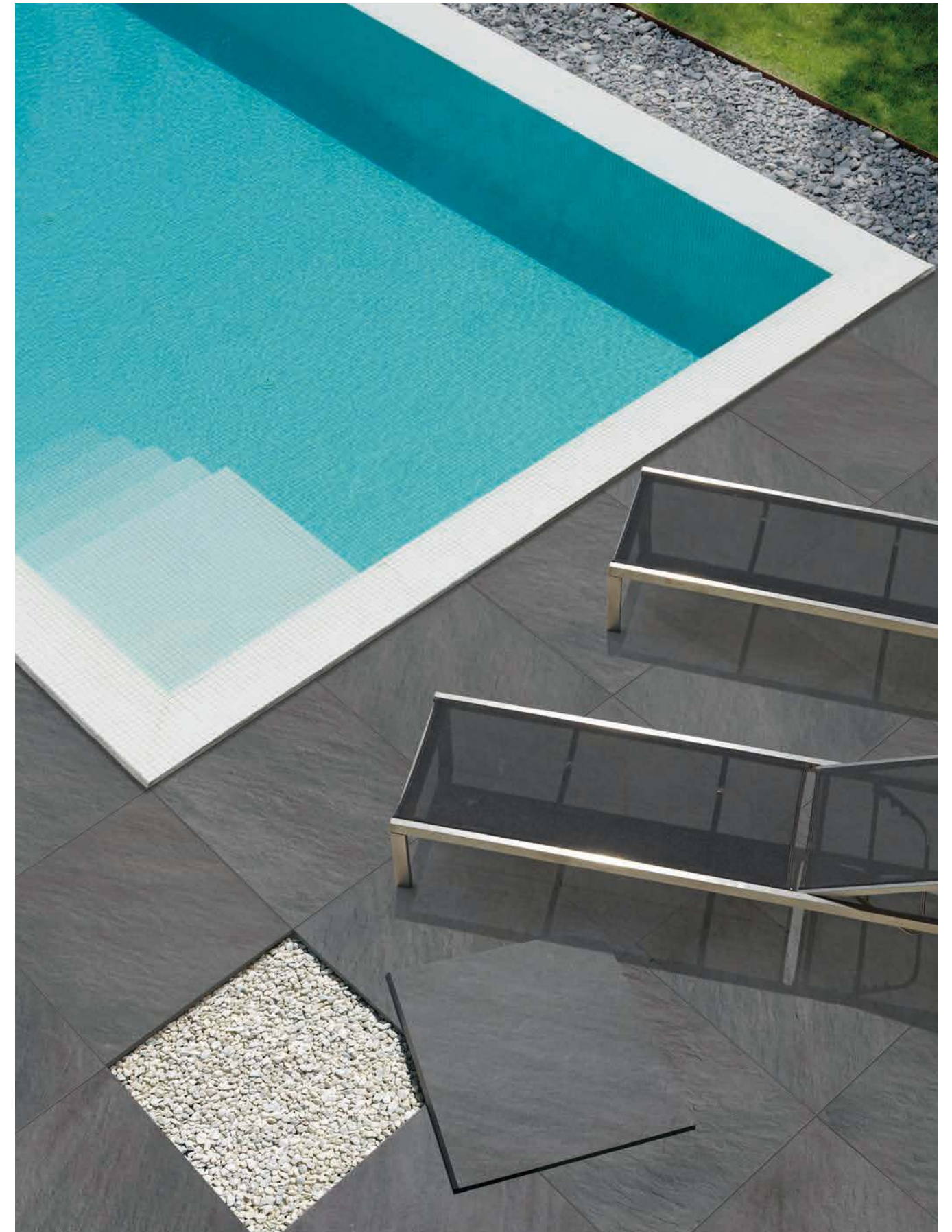

# XTREME 2.0

PORCELÁNICO~PORCELAIN TILE~GRÉS CÉRAME~FEINSTEINZEUG

∞ Dolmen Beige 60x60 Esp. rústico.



∞ Dolmen Beige 60x60 Esp. rústico.

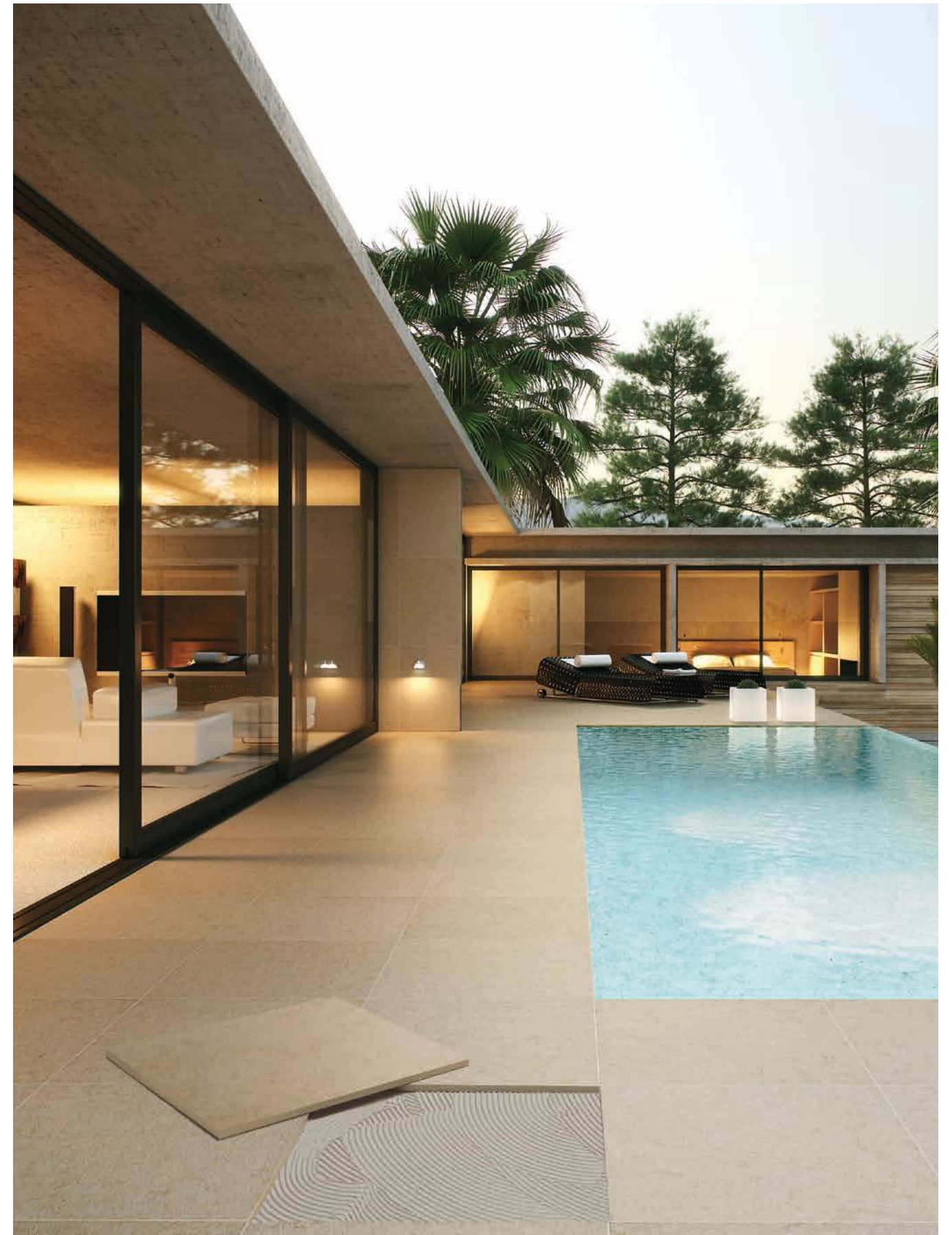

# XTREME 2.0

PORCELÁNICO~PORCELAIN TILE~GRÉS CÉRAME~FEINSTEINZEUG

≈ Dolmen Gris 60x60 Esp. rústico.

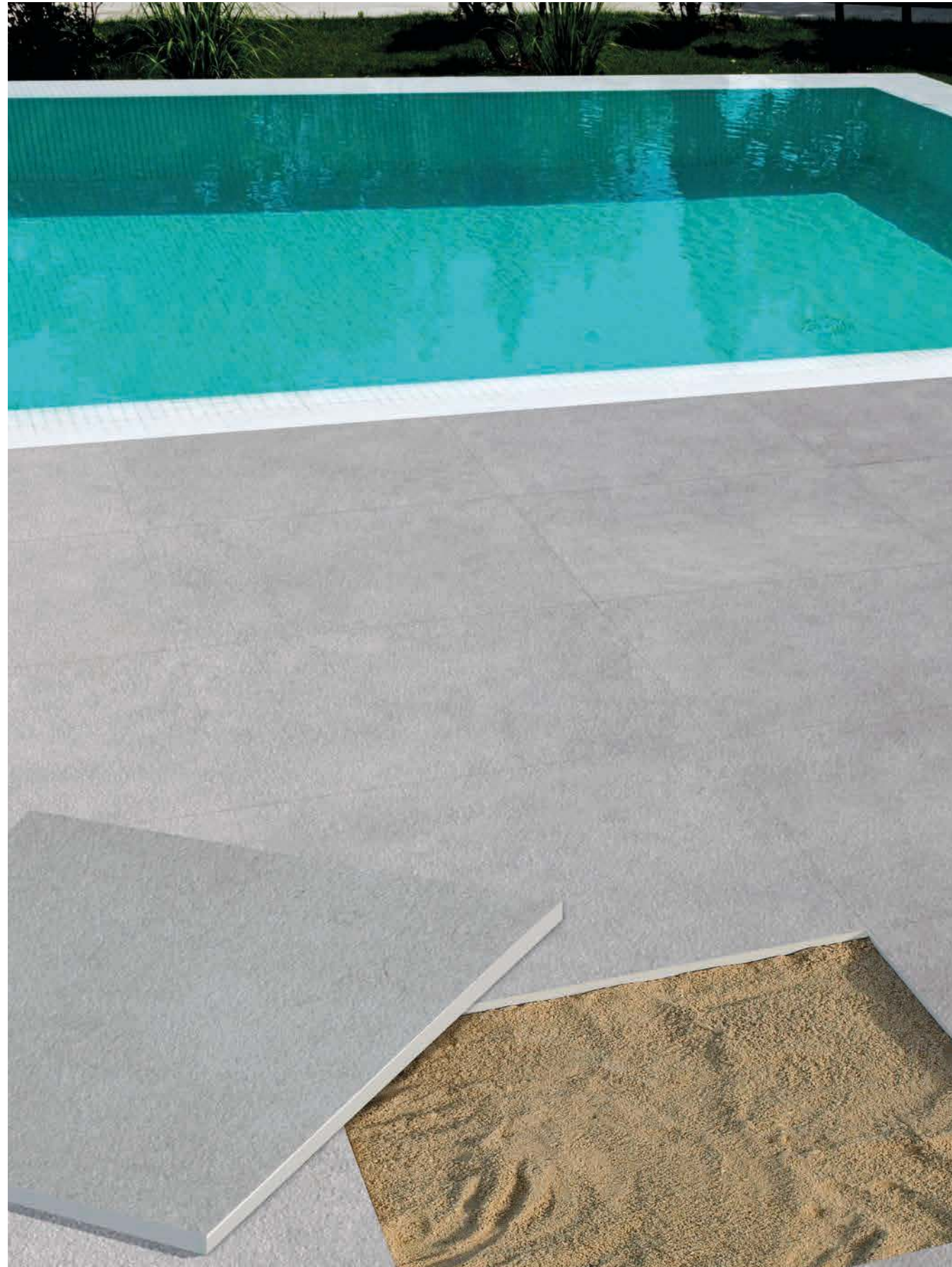

≈ Quarcity Negro 60x60 Esp. rústico.



# XTREME 2.0 // IRONWOOD

PORCELÁNICO~PORCELAIN TILE~GRÉS CÉRAME~FEINSTEINZEUG

W11 ABETO ≈



W12 FRESNO ≈



W13 BAMBÚ ≈



W14 OLIVO ≈



W15 CIPRÉS ≈



W16 ÉBANO ≈



20 mm.

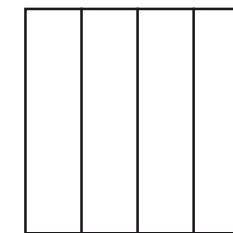

Esp. Natural B-110  
60 x 60 cm  
(24" x 24")

20 mm.

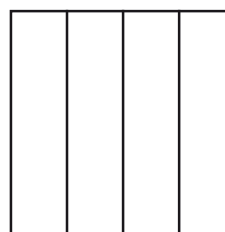

Esp. Natural B-110  
60 x 60 cm  
(24" x 24")

## PACKING LIST

PIEZAS BASE~BASIC TILES~ELÉMENTS DE BASE~GRUNDFLIESEN

CM	SIZE	ACABADO/FINISH	PIEZAS CAJA/ PIECES BOX	KG CAJA	M² CAJA	SQFT BOX	CAJAS/BOXES EUROPALET	M² EUROPALET	SQFT EUROPALET	KG EUROPALET
60 x 60	24" x 24"	ESP NATURAL	2	34,00	0,720	7,75	30	21,60	232,50	1.047,00

# XTREME 2.0 // DOLMEN

PORCELÁNICO~PORCELAIN TILE~GRÉS CÉRAME~FEINSTEINZEUG

D12 BEIGE ∨



D15 NACAR ∨



D11 GRIS ∨

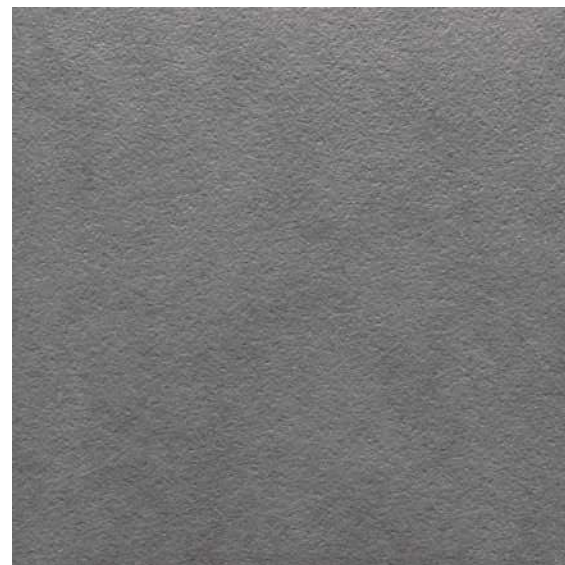

D14 GRAFITO ∨



20 mm.

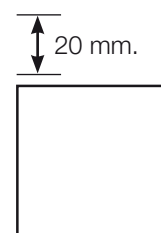

Esp. Rústico B-105  
60 x 60 cm  
(24" x 24")

Esp. Rústico B-85  
45 x 45 cm  
(18" x 18")

# XTREME 2.0 // QUARCITY

PORCELÁNICO~PORCELAIN TILE~GRÉS CÉRAME~FEINSTEINZEUG

Q02 BEIGE ∨



Q01 GRIS ∨



Q04 GRAFITO ∨

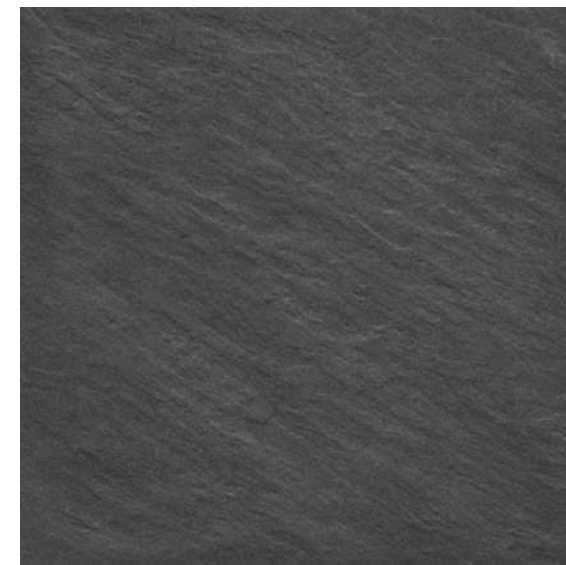

Q09 NEGRO ∨



20 mm.



Esp. Rústico B-105  
60 x 60 cm  
(24" x 24")

## PACKING LIST

PIEZAS BASE~BASIC TILES~ÉLÉMENTS DE BASE~GRUNDFLIESEN

CM	ACABADO/FINISH	PIEZAS CAJA/ PIECES BOX	KG CAJA	M² CAJA	CAJAS/BOXES EUROPALET	M² EUROPALET	KG EUROPALET
45 x 45	ESP RÚSTICO	2	18,80	0,405	39	15,79	760,20
60 x 60	ESP RÚSTICO	2	34,00	0,720	30	21,60	1.047,00

# XTREME 2.0 // QUANTUM

PORCELÁNICO≈PORCELAIN TILE≈GRÉS CÉRAME≈FEINSTEINZEUG

## Q22 BEIGE



## Q21 GRIS

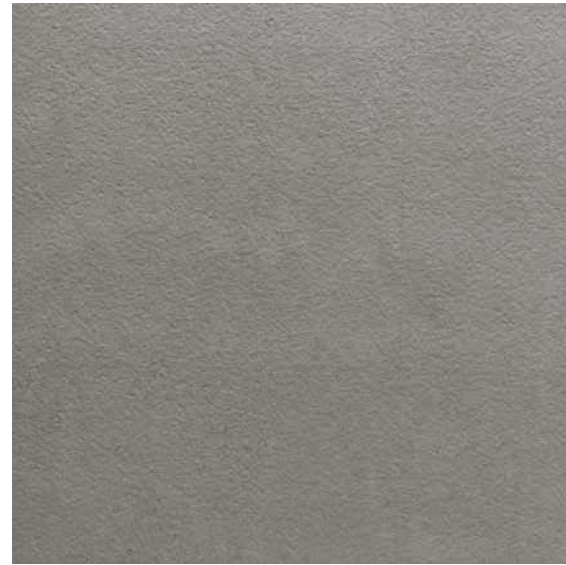

## Q24 GRAFITO

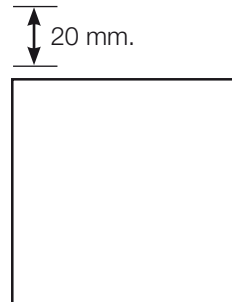
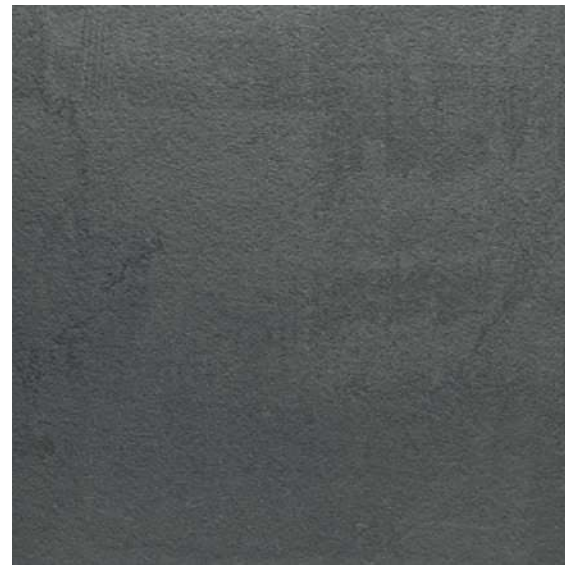

Esp. Rústico B-109  
60 x 60 cm  
(24" x 24")

### PACKING LIST

PIEZAS BASE≈BASIC TILES≈ELÉMENTS DE BASE≈GRUNDFLIESEN

CM	ACABADO/FINISH	PIEZAS CAJA/ PIECES BOX	KG CAJA	M² CAJA	CAJAS/BOXES EUROPALET	M² EUROPALET	KG EUROPALET
60 x 60	ESP RÚSTICO	2	34,00	0,720	30	21,60	1.047,00

# XTREME 2.0

PORCELÁNICO≈PORCELAIN TILE≈GRÉS CÉRAME≈FEINSTEINZEUG

## PIEZAS COMPLEMENTARIAS≈ACCESSORIES≈ ACCESSOIRES ET DECORATIONS≈FORMTEILE

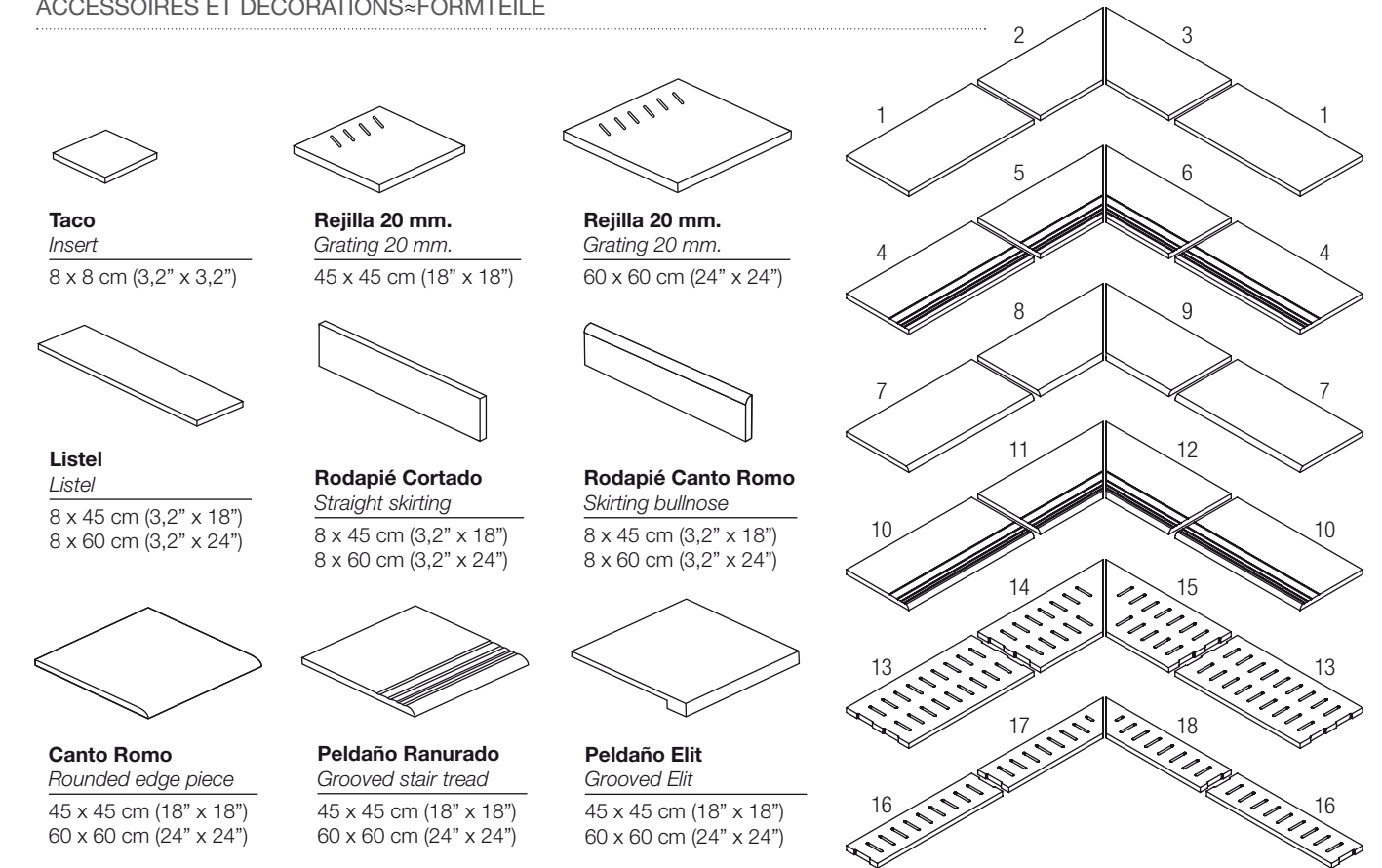

### Taco Insert

8 x 8 cm (3,2" x 3,2")

### Rejilla 20 mm. Grating 20 mm.

45 x 45 cm (18" x 18")

### Rejilla 20 mm. Grating 20 mm.

60 x 60 cm (24" x 24")

### Listel Listel

8 x 45 cm (3,2" x 18")  
8 x 60 cm (3,2" x 24")

### Rodapié Cortado Straight skirting

8 x 45 cm (3,2" x 18")  
8 x 60 cm (3,2" x 24")

### Rodapié Canto Romo Skirting bullnose

8 x 45 cm (3,2" x 18")  
8 x 60 cm (3,2" x 24")

### Canto Romo Rounded edge piece

45 x 45 cm (18" x 18")  
60 x 60 cm (24" x 24")

### Peldaño Ranurado Grooved stair tread

45 x 45 cm (18" x 18")  
60 x 60 cm (24" x 24")

### Peldaño Elit Grooved Elit

45 x 45 cm (18" x 18")  
60 x 60 cm (24" x 24")

### PACKING LIST

PIEZAS ESPECIALES≈SPECIAL ACCESSORIES≈ELÉMENTS SPÉCIAUX≈SPEZIALTEILE

#### ESPESORADO

Taco - Insert	8x8	3,2" x 3,2"	RÚSTICO	P-02
Rodapié Cortado - Straight skirting	8x45	3,2" x 18"	RÚSTICO	P-04
Rodapié Cortado - Straight skirting	8x60	3,2" x 24"	TODOS	P-06
Rodapié Canto Romo - Skirting bullnose	8x45	3,2" x 18"	RÚSTICO	P-05
Rodapié Canto Romo - Skirting bullnose	8x60	3,2" x 24"	TODOS	P-09
Listel	8x45	3,2" x 18"	RÚSTICO	P-04
Listel	8x60	3,2" x 24"	TODOS	P-06
Canto Romo 1 lado - Rounded edge piece 1 side	45x45	18" x 18"	RÚSTICO	P-22
Canto Romo 1 lado - Rounded edge piece 1 side	60x60	24" x 24"	TODOS	P-40
Canto Romo 2 lados - Rounded edge piece 2 sides	45x45	18" x 18"	RÚSTICO	P-27
Canto Romo 2 lados - Rounded edge piece 2 sides	60x60	24" x 24"	TODOS	P-47
Peldaño Ranurado - Grooved stair tread	45x45	18" x 18"	RÚSTICO	P-22
Peldaño Ranurado - Grooved stair tread	60x60	24" x 24"	TODOS	P-40
Peldaño Ranurado Esquina - Grooved stair tread corner	45x45	18" x 18"	RÚSTICO	P-27
Peldaño Ranurado Esquina - Grooved stair tread corner	60x60	24" x 24"	TODOS	P-47
Peldaño Elit - Elit step	45x45	18" x 18"	RÚSTICO	P-50
Peldaño Elit - Elit step	60x60	24" x 24"	TODOS	P-85
Peldaño Elit Esquina - Elit step corner	45x45	18" x 18"	RÚSTICO	P-79
Peldaño Elit Esquina - Elit step corner	60x60	24" x 24"	TODOS	P-132
Rejilla - Grating	45x45	18" x 18"	RÚSTICO	P-55
Rejilla - Grating	60x60	24" x 24"	TODOS	P-63

1- Peldaño Recto - Rectified step edge	30x60	12" x 24"	TODOS	P-24
2- Ángulo izquierdo Peldaño Recto - Rectified left mitred corner	30x60	12" x 24"	TODOS	P-29
3- Ángulo derecho Peldaño Recto - Rectified right mitred corner	30x60	12" x 24"	TODOS	P-29
4- Peldaño Recto Ranurado - Grooved step edge	30x60	12" x 24"	TODOS	P-27
5- Ángulo izquierdo Peldaño Recto Ranurado - Grooved left mitred corner	30x60	12" x 24"	TODOS	P-32
6- Ángulo derecho Peldaño Recto Ranurado - Grooved right mitred corner	30x60	12" x 24"	TODOS	P-32
7- Peldaño Canto Romo - Round edge	30x60	12" x 24"	TODOS	P-30
8- Ángulo izquierdo Peldaño Canto Romo - Right mitred round edge	30x60	12" x 24"	TODOS	P-35
9- Ángulo derecho Peldaño Canto Romo - Left mitred round edge	30x60	12" x 24"	TODOS	P-35
10- Peldaño Canto Romo Ranurado - Grooved stair tread	30x60	12" x 24"	TODOS	P-30
11- Ángulo izquierdo Peldaño Canto Romo Ranurado - Left mitred grooved stair tread	30x60	12" x 24"	TODOS	P-35
12- Ángulo derecho Peldaño Canto Romo Ranurado - Right mitred grooved stair tread	30x60	12" x 24"	TODOS	P-35
13- Rejilla - Grating	30x60	12" x 24"	TODOS	P-78
14- Ángulo izquierdo Rejilla - Left mitred grating	30x60	12" x 24"	TODOS	P-78
15- Ángulo derecho Rejilla - Right mitred grating	30x60	12" x 24"	TODOS	P-78
16- Rejilla - Grating	15x60	6" x 24"	TODOS	P-38
17- Ángulo izquierdo Rejilla - Left mitred grating	15x60	6" x 24"	TODOS	P-38
18- Ángulo derecho Rejilla - Right mitred grating	15x60	6" x 24"	TODOS	P-38

Estas piezas se venden por unidad, a excepción de los rodapiés que se venden en cajas de 5 uds.

These items are sold by pieces with the exception of the skirtings which are sold by boxes of 5 pieces each.

Unité de vente à la pièce, sauf les plinthes vendus à la boîte de 5 unités.

Die Formteile sind pro Stück verkauft außer die Sockel, die pro Karton mit 5 Stück verkauft sind.

# Información Técnica

TECHNICAL INFORMATION  
INFORMATIONS TECHNIQUES  
TECHNISCHE AUSKUNFT







# Expertos en calidad

QUALITY EXPERTS  
EXPERTS DE QUALITÉ  
QUALITÄTS-FACHLEUTE

## ES

Desde la fase más primaria de su fabricación, en la que se seleccionan las materias primas, hasta la obtención del producto final, el "Porcelánico Integral" de Alcalagres, se caracteriza por el compromiso que la compañía tiene con la calidad, la investigación, el desarrollo y el diseño. Las características técnicas finales de alta resistencia a la flexión, al tránsito intenso de personas, a la rodadura, a las heladas, al ataque químico, el bajo nivel de absorción de agua, < 0,1% y la variedad de formatos resultantes en el proceso fabril, hacen del Porcelánico Integral un material imprescindible para los profesionales, especialmente cuando se proponen abordar un nuevo proyecto con soluciones duraderas, resistentes y decorativas. En la línea de aportar el máximo de soluciones a los profesionales del sector, Alcalagres fabrica el Porcelánico Integral en formato de 300x300, 300x600, 400x400, 450x450, 600x600 y 450x900 siempre rectificado y monocalibre, dichos formatos se encuentran disponibles en diferentes series con acabados en mate, lucidato, rústico, natural o pulido en función de la serie a la que se haga referencia. Alcalagres, en su compromiso constante con la calidad, ha obtenido en Septiembre 2013 la certificación NF UPEC que garantiza unos resultados excepcionales de desgaste, ruptura, resistencia química y manchado.

## EN

From the initial manufacturing stage, in which the raw materials are selected until the end product is obtained, the Alcalagres Integral Porcelain Tile is characterised by the company's commitment to quality, research, development and design. The final technical characteristics of high resistance to flexion, intense movement of people, rolling, frost, chemical aggression, low level of water absorption, < 0.1% and the variety of formats available from the manufacturing process, make the Integral Porcelain Tile an essential material for professionals, particularly when faced with a new project requiring long lasting, resistant and decorative solutions. In its efforts to provide maximum solutions to professionals of the sector, Alcalagres manufactures rectified and single caliber Integral Porcelain Tiles in 300x300, 300x600, 400x400, 450x450, 600x600 and 450x900 formats, which are available in different series with mate, lucidato, rústico, natural or pulido finishes, depending on the intended use of the series in question. Alcalagres in its ongoing commitment to quality, obtained last September 2013 the certification NF UPEC that guarantees exceptional results of wear, breakage, chemical resistance and stained.

## FR

De la phase la plus primaire de sa fabrication, dans le cadre de laquelle les matières premières sont sélectionnées, à l'obtention du produit final, le « grès porcelainé intégral » d'Alcalagres reflète l'engagement de la société pour la qualité, la recherche, le développement et le design. Les caractéristiques techniques de haute résistance à la flexion, au trafic intense de personnes, au roulement, au gel et aux produits chimiques, de même que le faible niveau d'absorption d'eau, < 0,1 %, et la grande variété de formats résultant du procédé de production, font du grès porcelainé intégral un matériau indispensable pour les professionnels, en particulier lorsque ces derniers se proposent d'aborder de nouveaux projets avec des solutions durables, résistantes et décoratives. Dans un souci d'apporter un maximum de solutions aux professionnels du secteur, la société Alcalagres fabrique son grès porcelainé intégral dans les formats 300x300, 300x600, 400x400, 450x450, 600x600 et 450x900, toujours rectifiés et avec un calibre unique. Ces formats sont disponibles dans différentes séries présentant des finitions mate, lucidato, rústico, natural ou pulido en fonction de la série en question. Alcalagres dans son engagement continu vers la qualité a obtenu en Septembre 2013 la certification NF UPEC qui garantit des résultats exceptionnels à l'usure, rupture, résistance chimique et aux taches.

## DE

Bereits vom Augenblick der ersten Produktionsphase an, wenn die Rohstoffe ausgewählt werden, bis zum Erhalt des Endprodukts ist das „ganzscherbis durchgefärbte Feinsteinzeug“ von Alcalagres durch die Verpflichtung des Unternehmens für Qualität, Forschung, Entwicklung und Design geprägt. Die sich daraus ergebenden technischen Merkmale, also die hohe Biegefestigkeit, die Abriebbeständigkeit bei starkem Personenverkehr und bei Befahrung, die Beständigkeit bei Frost und chemischen Einwirkungen, die geringe Wasseraufnahme (< 0,1%) und die vielen verschiedenen Formate, die sich aus dem Herstellungsprozess ergeben, machen das ganzscherbis durchgefärbte Feinsteinzeug zu einem Material, das für professionelle Projekte unerlässlich ist, insbesondere wenn dafür dauerhafte, widerstandsfähige und dekorative Lösungen gesucht werden. Mit dem Ziel, den Fachleuten in der Branche ein optimales Lösungsangebot zur Verfügung zu stellen, wird bei Alcalagres ganzscherbis durchgefärbtes Feinsteinzeug in den Formaten 300x300, 300x600, 400x400, 450x450, 600x600 und 450x900 hergestellt, und zwar immer kalibriert und mit einem einzigen Kaliber. Diese Formate werden in verschiedenen Serien und, je nach der Serie, in den Ausführungen mate, lucidato, rústico, natural oder pulido angeboten. Alcalagres, in seine ständige Verpflichtung zur Qualität, erhielt in September 2013 die Zertifizierung NF UPEC, nach diesem Ergebnisse garantieren wir Abrieb, Bruch und chemische Beständigkeit unserer Produkte.

análisis características de materiales ≈ comparison of material characteristics

	Madera Wood	Acero Steel	Hormigón Concrete	Calizas Limestone	Mármol Marble	Granito Granite	"Porcelánico Integral" Integral Porcelain Tiles
Resistencia Flexión ≈ Bending strength							
Resistencia Helada ≈ Frost resistance							
Toleranc. Dimensionales ≈ Dimensional tolerances							
Expansión amb. Húmedo ≈ Moisture expansion							
Coef. Lineal Dilatación ≈ Linear expansion coefficient							
Resistencia Manchas ≈ Resistance to staining							
Corrosión Niebla Salina ≈ Salt-spray corrosion							
Degradación por acc. Solar ≈ Degradation from solar radiation							

muy alto / extreme  
 alto / high  
 medio / medium  
 bajo / low

# Antideslizante

ANTI-SLIP  
ANTIDÉRAPANT  
RUTSCHHEMMEND



## ■ ES

ALCALAGRES mantiene una política de inversión permanente en I+D logrando así ofrecer una amplia gama de modelos para todos los lugares donde se deben cumplir los valores exigidos de resistencia al deslizamiento. La necesidad de evitar resbalones y caídas es imperativa en exteriores, zonas húmedas interiores, aceras, plazas, vestíbulos, cocinas industriales, baños colectivos, piscinas, ...

El Código Técnico de la Edificación, atendiendo la demanda de calidad en los edificios y espacios urbanos, regula unas exigencias que afectan directamente a las baldosas cerámicas en el Documento Básico SU 1 de seguridad frente al riesgo de caídas.

El método establecido para determinar los coeficientes de resistencia al deslizamiento es el del Péndulo según la norma UNE-ENV 12633-2003. La clasificación del pavimento según su valor de resistencia al deslizamiento (Rd) determina la Clase del mismo, que en función de su localización, es exigida por las diferentes normas.

## ■ EN

ALCALAGRES is committed to ongoing investment into R&D. In this way, it can offer a range of models suitable for settings of all kinds where a specific slip resistance is required. It is essential to prevent slippery surfaces or falls outdoors, in wet indoor areas, on pavements, and in squares, lobbies, hallways, industrial kitchens, public toilets and swimming pools, among other places.

In response to the demand for high standards in buildings and urban spaces, the Spanish Building Code's Basic Safety Document SU 1 on the prevention of falls regulates certain requirements directly related to ceramic tiles.

The pendulum method is the established system of determining slip resistance values, in accordance with standard UNE-ENV 12633-2003. A floor covering's slip resistance value determines the class to which it belongs, with a certain class being required for specific locations, as regulated in different standards.

## ■ FR

ALCALAGRES met en œuvre une politique d'investissements permanents en R&D visant à être en mesure de proposer une vaste gamme de modèles valables pour tous les endroits où il est nécessaire de respecter les valeurs exigées de résistance à la glissance. Il est impératif d'éviter les dérapages et les chutes dans les espaces extérieurs, dans les zones humides intérieures, sur les trottoirs et les places, dans les vestibules, les cuisines industrielles, les bains collectifs, les piscines, etc.

Soucieux d'accroître la qualité des bâtiments et des espaces urbains, le Code Technique espagnol du Bâtiment impose, dans son Document de Base SU 1 de sécurité contre le risque de chutes, des exigences qui affectent directement les carreaux céramiques.

La méthode établie pour déterminer les coefficients de résistance à la glissance est celle du Pendule selon la norme UNE-ENV 12633-2003. La classification du revêtement de sol en fonction de sa valeur de résistance à la glissance détermine la Classe de celui-ci exigée par les différentes normes selon le lieu où il est posé.

## ■ DE

ALCALAGRES behält die Politik der permanenten Investition in F+E bei. Das führt dazu, dass das Unternehmen über ein umfangreiches Sortiment an Modellen verfügt, die überall dort verwendet werden können, wo die erforderlichen Rutschhemmungswerte eingehalten werden müssen. In Außenbereichen, Feuchtbereichen im Gebäudeinneren, Gehwegen, Plätzen, Foyers, Gewerbeküchen, kollektiven Bädern, Schwimmbädern usw. ist es absolut notwendig, eine Rutsch- und Sturzgefahr zu vermeiden.

Die spanische Technische Gebäudeordnung regelt mit ihrem Basisdokument SU1 über Sturzsicherheit bezüglich der Qualitätsforderungen in Gebäuden und städtischen Bereichen die Anforderungen, die sich direkt auf Keramikfliesen beziehen.

Das festgelegte Verfahren zur Bestimmung des Rutschwiderstandskoeffizienten ist das Pendelverfahren gemäß der Vorschrift UNE-ENV 12633-2003. Die Einstufung der Bodenbeläge entsprechend dem Rutschwiderstandswert (SRV – Slip Resistance Value) bestimmt die entsprechende Klasse, die je nach Standort von den verschiedenen Vorschriften für Bodenbeläge gefordert wird.

	UNE-ENV 12633:2003	DIN 51130	DIN 51097
Concept Rústico	Clase 3	R12	Grupo C
Dolmen Rústico	Clase 3	R12	Grupo C
Ironwood Natural 15x90 & 22,5x90	Clase 3	R11	
Ironwood Natural 60x60 20 mm.	Clase 3	R12	Grupo C
Lifestone Antideslizante	Clase 3	R10	Grupo C
Maderas Natural	Clase 3		
Onix Rústico	Clase 2	R10	Grupo C
Quantum Rústico	Clase 3	R12	Grupo C
Quarcity Rústico	Clase 3	R12	Grupo C
Rios Antideslizante	Clase 3		
Rios Trafic	Clase 3	R12	Grupo C
Roma Antideslizante	Clase 3	R10	Grupo C
Silex Rústico	Clase 2	R10	
Táctil	Clase 3		
Técnika Mate	Clase 1	R10	

# Aplicaciones especiales

SPECIAL APPLICATIONS  
APPLICATIONS SPÉCIALES  
SPEZIAL ANWENDUNGEN

---

## ■ ES

El porcelánico integral alcalagres está especialmente recomendado para su uso en grandes superficies o de alto tránsito y en aquellas zonas que exijan resistencia a los ácidos y requieran facilidad de limpieza.

Nuestra amplia gama de modelos y en especial los esponsorados de 300x300x12 y 400x400x14 forman parte de la imagen corporativa de la mayoría de las grandes firmas de supermercados, concesionarios, oficinas bancarias... en definitiva, nuestros materiales ofrecen el mejor de los resultados al menor coste posible, facilitando la fusión de la resistencia, la seguridad y la estética en un único producto.

Somos pioneros en la aplicación de técnicas de decoración y fabricación de piezas especiales en porcelánico. Ofrecemos nuestra experiencia en estos campos para que proyectos sencillos o de gran complejidad puedan ser diseñados y ejecutados sin dificultad.

## ■ EN

Alcalagres integral porcelain tiles are specially recommended for use in shopping centres or places subject to heavy traffic and in areas that must be acid resistant and easy to clean.

Our wide range of models, especially the extra-thick 300x300x12 and 400x400x14 tiles, form a part of the corporate image of the majority of large supermarket companies, vehicle dealerships and banks. Our materials offer the best results at the lowest possible cost, combining the very utmost in resistance, safety and appearance in a single product.

We are pioneers in the application of decorative techniques and the manufacture of special porcelain tile pieces. We offer our experience in these areas so that simple or highly complex projects can be designed and completed without difficulty.



## ■ FR

Le grès porcelainé intégral alcalagres est tout particulièrement recommandé dans les grandes surfaces commerciales et les espaces à trafic intense, ainsi que dans les zones exigeant une bonne résistance aux acides et une grande facilité de nettoyage.

Notre vaste gamme de modèles, et en particulier ceux de grande épaisseur en formats 300x300x12 et 400x400x14, fait partie de l'image de marque de la plupart des grandes chaînes de supermarchés, de concessionnaires, de succursales bancaires, etc. En définitive, nos matériaux garantissent le meilleur des résultats au moindre coût possible et allient résistance, sécurité et esthétique dans un seul produit.

Nous sommes pionniers dans l'application de techniques de décoration et de fabrication de pièces spéciales en grès porcelainé. Nous apportons notre expérience dans ces domaines pour que tout projet, du plus simple au plus complexe, puisse être mis sur pied et exécuté sans aucune difficulté.

## ■ DE

Das ganzscherbig durchgefärbte Feinsteinzeug von Alcalagres wird speziell zur Verwendung in Einkaufszentren, für stark begangene Flächen oder in all denjenigen Bereichen empfohlen, wo eine hohe Frostsicherheit gegen Säuren erforderlich ist und die leicht zu reinigen sein müssen.

Unser großes Sortiment an Modellen und insbesondere die dickeren Ausführungen in 300x300x12 und 400x400x14 gehören bereits zum Unternehmensimage der meisten großen Supermarktketten, Fahrzeughändler, Bankfilialen usw., kurz, unsere Materialien bieten beste Ergebnisse zum kleinstmöglichen Preis und machen es möglich, Widerstandsfähigkeit, Sicherheit und Ästhetik in einem einzigen Produkt zu vereinen.

Wir sind wegweisend in der Anwendung von Dekorationstechniken und der Herstellung von Formteilen aus Feinsteinzeug. Wir stellen unseren Kunden unsere Erfahrung auf diesen Gebieten zur Verfügung, damit einfache wie auch sehr komplizierte Projekte problemlos entworfen und ausgeführt werden können.





# Características técnicas

TECHNICAL CHARACTERISTICS  
 CARACTÉRISTIQUES TECHNIQUES  
 TECHNISCHE EIGENSCHAFTEN

## CARACTERÍSTICAS TÉCNICAS TECHNICAL CHARACTERISTICS

			UNE-EN ISO 10545 Test Nº	UNE EN 14411 <sup>(1)</sup> Grupo B1a E≤ 0.5% UGL	ALCALAGRES Valores 1ª calidad 1 <sup>st</sup> quality values
	LONGITUD Length and width	Desviación W	2	0.6%	± 0.2%
	ESPESOR Thickness	Desviación W	2	5.0%	± 5.0%
	RECTITUD DE LOS LADOS Warpage of edges		2	0.5%	± 0.2%
	ORTOGONALIDAD Wedging		2	0.6%	± 0.25%
	CURVATURA CENTRAL Central curvatura		2	0.5%	± 0.2%
	CURVATURA LATERAL Edge curvatura		2	0.5%	± 0.2%
	ALABEO Warpage		2	0.5%	± 0.2%
	ASPECTO SUPERFICIAL Surface quality		2	95.0%	Cumple
	ABSORCIÓN DE AGUA Water absorption		3	≤ 0.5% max 0.6 %	≤ 0.1%
	FUERZA DE ROTURA Breaking strength	e ≥ 7.5 mm	4	≥ 1300 N	≥ 2000 N <sup>(3)</sup>
	RESISTENCIA A LA FLEXIÓN Modulus of rupture		4	≥ 35 N/mm <sup>2</sup>	≥ 45 N/mm <sup>2</sup>
	RESISTENCIA AL IMPACTO Impact resistance		5	MD	0.85
	ABRASIÓN PROFUNDA Deep abrasion	UGL	6	< 175 mm <sup>3</sup>	< 145 mm <sup>3</sup>
	RESISTENCIA A LA ABRASIÓN Abrasion resistance		7	SF	Según modelo
	DILATACIÓN TÉRMICA LINEAL Linear thermal-expansion		8	MD	< 7.5x10 <sup>-6</sup> °C <sup>-1</sup>
	CHOQUE TÉRMICO Thermal shock		9	MD	Resiste
	EXPANSIÓN POR HUMEDAD Moisture Expansion		10	MD	Según modelo
	RESISTENCIA AL HIELO Frost resistance		12	Exigido	Resiste
	ACIDOS Y BASES (N-D-L-R-B) P <sup>(2)</sup> Acid and alkali resistance (N-D-L-R-B) P <sup>(2)</sup>	Ácidos baja concentración	13	MD	ULA/ULA <sup>(2)</sup>
		Ácidos alta concentración	13	MD	UHA/UHA <sup>(2)</sup>
		Bases baja concentración	13	MD	ULA/ULC <sup>(2)</sup>
		Bases alta concentración	13	MD	UHA/UHC <sup>(2)</sup>
	RESISTENCIA A PRODUCTOS QUÍMICOS DOMÉSTICOS Y REACTIVOS DE PISCINAS Household detergents and additives for swimming-pools	UGL	13	Mínimo UB	UA
	MANCHAS Stains	UGL	14	MD	4/5

## ES

Los más prestigiosos laboratorios del mundo han realizado pruebas sobre el porcelánico ALCALAGRES, obteniendo en todos los casos resultados superiores a los exigidos por las normas de aplicación.

## FR

Les plus prestigieuses laboratoires du monde ont réalisé des essais avec le grès cérame ALCALAGRES ayant obtenu dans tous les cas des résultats supérieurs à ceux exigés par les normes d'application.

## EN

ALCALAGRES porcelain tile has undergone testing at the most prestigious laboratories in the world, and exceeds the norms for testing in all areas.

## DE

Die renommiertesten Laboratorien der Welt haben das Feinsteinzeug ALCALAGRES geprüft. Hierbei wurden die geforderten Anwendungsergebnisse bei weitem übertroffen.

## NORMAS COMPLEMENTARIAS COMPLEMENTARY NORMS

	DESPLIZAMIENTO (Péndulo) Antislip (Pendulum)	UNE-ENV 12633	Clase 1 /Clase 2/ Clase 3	Según acabado
	DESPLIZAMIENTO (DIN) Antislip	DIN 51130	R9 / R10 / R11 / R12	Según acabado
	DESPLIZAMIENTO (Pies descalzos) Antislip (Barefoot)	DIN 51097	Grupo A-B-C	Según acabado
	MATERIAL RECICLADO Recycled material	ISO 14021		Según modelo
	RESISTENCIA DE LOS COLORES A LA LUZ Colour resistance to light	DIN 51094		Resiste



(1) Valor según Norma UNE EN 14411: W= Dimensión de fabricación • SF= Según el fabricante • MD= Método disponible.  
 Values according to UNE EN 14411: W= Manufacturer's dimensions • SF= According to manufacturer • MD= According to available test.  
 Valeur selon la Norme ISO 14411: W=Dimension de fabrication • SF=Selon le fabricant • MD=Méthode disponible  
 Werte nach ISO 14411: W=Fabrikationsmaße • SF= lt. Angaben des Herstellers • MD= Methode verfügbar

(2) Excepto ácido fluorhídrico. La sosa cáustica pura puede alterar el aspecto pulido pero no las características técnicas del material.  
 Except fluorhydric acid. Pure caustic soda can alter the polished finish, but will not affect the technical characteristics of the material.  
 Excepté l'acide fluorhydrique.  
 Mit Ausnahme von Fluorwasserstoffsäure.

(3) Mín 2000 N, variable según modelo.  
 Minimum 2000 N, may vary depending on the model.  
 Minimum 2000 N, variable selon modèle.  
 Minimal 2000 N, veränderliche auf jeden Modell.

# Instalación

## Colocación: recomendaciones

INSTALLATION TILE LAYING : TIPS AND ADVICE

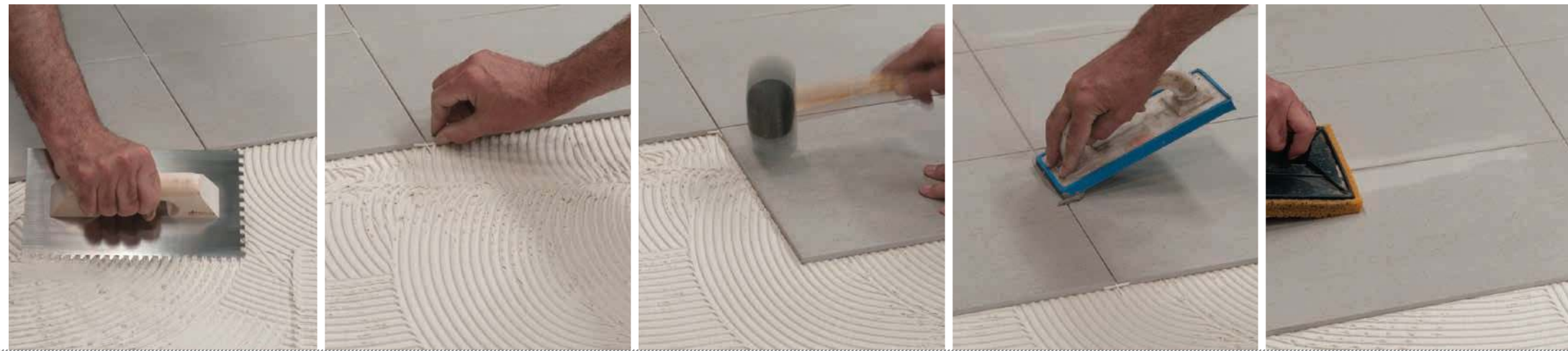

### ES

Un producto innovador, como el Porcelánico Integral ALCALAGRES exige que se empleen los sistemas y materiales más adecuados en su colocación. Su correcta manipulación por profesionales realzará la belleza del acabado final y asegurará su durabilidad, especialmente cuando se utilice en lugares de uso colectivo. La colocación de este material deberá realizarse con adhesivos cementosos (C2) adhesivos en dispersión (D2) o adhesivos de reacción (R2) todos ellos específicos para gres porcelánico, especialmente en pavimentos de exteriores, grandes superficies y en todos los revestimientos. Al usar este tipo de adhesivos siempre se deberán seguir las indicaciones del fabricante para su preparación y comprobar que, efectivamente, está recomendado para gres porcelánico. En el mercado actual existen gran variedad de marcas entre las que elegir. La utilización de morteros tradicionales NO aporta una adherencia suficiente.

En primer lugar el profesional de la colocación deberá verificar que el material suministrado se ajusta a lo especificado en el pedido, ALCALAGRES, S.A., especifica siempre en sus cajas modelo, tono y calibre, por lo que no acepta reclamaciones sobre materiales ya colocados por motivos de confusión. Existen modelos del catálogo de ALCALAGRES con una destonificación intencionada en su diseño y producción haciendo cada pieza diferente tal y como se encuentran las piedras naturales en la naturaleza. Si se realizan diseños atrevidos y personalizados se deberá realizar una planificación previa en el suelo sin adhesivo para observar el resultado final. Hay que prestar especial atención al sentido de vetas y motivos de decoración de la superficie de los modelos y establecer de ante mano el criterio a seguir. Una vez preparada, seca y limpia la capa de nivelación, colocar el Porcelánico Integral ALCALAGRES con un buen adhesivo de mortero cola, específico para porcelánico. Emplear una llana dentada de 6 mm para piezas 30x30 o medidas inferiores, a partir de esta medida emplear una llana dentada de 9 a 10 mm y si es preciso aplicar doble encolado (en el soporte y en el reverso de la pieza) con lo que se consigue reforzar la adhesión con el soporte. Es de suma importancia colocar las piezas debidamente niveladas evitando cejas y lograr de esta manera una superficie totalmente plana. Se recomienda emplear mazas de goma blanca para igualar las piezas, las mazas oscuras dejan marcas que obligan posteriormente a limpiezas especiales. Cuando se trabaje con formatos rectangulares se recomienda no colocarlos de forma trabada a mitad de pieza y hacerlo a 1/4 o a 1/5 de la pieza. Es muy importante que se respeten los tiempos de secado que especifique el fabricante del mortero cola y no se tran-

sitar por el pavimento antes de este plazo. Aunque el porcelánico integral de ALCALAGRES, S.A. es resistente al ataque, químico y a la abrasión, se aconseja protegerlo, una vez finalizado el montaje del pavimento de cara a la ejecución del resto de oficios. El material de rejunte debe ser adecuado para porcelánico, apropiado para cada tipo de colocación, uso del suelo o condiciones climáticas del entorno. Deberá ser aplicado con llana de goma dura para asegurar su penetración siguiendo siempre las instrucciones del fabricante (recomendaciones de uso). Una vez aplicado el relleno de las juntas, retirar el sobrante con una esponja y agua limpia antes que endurezca, con cuidado de no dañar la junta y siguiendo estrictamente las instrucciones del fabricante. Si queda algún resto de mortero de agarre o junta de cualquier clase, se deberá eliminar, siempre, bajo las indicaciones del fabricante y con los elementos que este determine. No emplear cemento blanco común ni material de juntas que contengan "negro de humo".

#### MANIPULADO DEL PORCELÁNICO

**Corte.** El Porcelánico Integral ALCALAGRES se caracteriza por su gran dureza lo que no impide que se pueda cortar cuando se realiza su instalación, con el fin de adaptarlo a la geometría del espacio donde vamos a colocarlo. - Los ingleses y cortes centrales para apliques de la luz o acometidas de tuberías deberá de hacerse con disco de diamante, refrigerado por agua - Los cortes rectos se realizan con facilidad con las máquinas más comunes que ya existen en el mercado adaptadas al uso para gres porcelánico. - Para cortes circulares de diferentes diámetros como entradas de tuberías, botes sifónicos, cierres de seguridad, etc, algunos fabricantes han desarrollado elementos de corte específicos que facilitan dichos corte y permiten un acabado satisfactorio.

**Perforación.** Para realizar perforaciones una vez colocado el porcelánico, no es necesario un taladro especial, basta con que cumpla con los siguientes requisitos: - Potencia  $\geq$  a 600W, selector de modo no percutor (rotación), selector de velocidades, porta brocas con apertura  $\geq$ 10mm, empuñadura adicional y tope de profundidad. - Se recomienda usar brocas específicas para porcelánico de carburo de tungsteno o de diamante, las cuales poseen diferentes formas de punta en función del uso que se requiera. En este caso, como en todos, seguiremos las especificaciones que nos indique el fabricante para cada uso.

Para ampliar la información, consulte nuestra página web: [www.alcalagres.com](http://www.alcalagres.com)

### EN

Laying an innovative product like ALCALAGRES integral porcelain tiles requires using the right materials and methodology. Expert tiling will enhance the beauty and guarantee a long lasting durability of a tiled surface, especially when the product is laid in a public area. As a general rule, cement-based tile adhesives (C2), dispersion adhesives (D2), or reaction resins (R2) are used to secure porcelain tiles, especially in big areas, outdoor surfaces and coverings in general. Follow the adhesive manufacturer's instructions and check that the product is recommended as a bonding agent to be used with porcelain gres tiles. There are a good number of products to choose from on the market. Traditional mortars are not recommended bonding agents.

Firstly, floor layers have to check that the materials they are about to work with are the ones indicated in the order. ALCALAGRES boxes indicate model, colour and calibre, and thus no claims will be accepted on laid floors. The ALCALAGRES range includes models whose individual tiles are manufactured in a way mirroring the variations of individual natural stone slabs or tiles. Creative, bespoke pattern designs need a preliminary laying plan. Just dry-lay the tiles on the floor to see what they will look like when your job is done. For your floor laying design, consider the tiles' veining and motifs. The subsurface must be flat, dry and clean before fixing the ALCALAGRES porcelain tiles with a good cement-based adhesive for specific use with porcelain tiles. Use a 6mm notched trowel with 30 x 30cm or smaller tiles, and a 9 to 10mm notched trowel with larger tiles or when a double-coat adhesive is applied to both the subsurface and the back of the tile to improve bonding. Make sure the tiles are flat and even. Use a white rubber mallet to level them out, since a dark coloured one will leave stains that are difficult to remove and require special cleaning methods. If you want to arrange rectangular tiles with a brickwork pattern, don't place tiles near to the middle of the adjacent one but 1/4 or 1/5 from the edge. Warning: Remember that tiles can be walked upon only when the adhesive has sealed. Check the adhesive manufacturer's instructions. Although ALCALAGRES porcelain tiles have good abrasion and chemical corrosion resistance, protecting the floor from damage by other improvement or construction work is highly recommended.

Only grout recommended for porcelain tiles should be used. There are special grouts for different laying methods, floor special use or purpose, and the weather. Grout must be applied with a hard rubber grout float that forces the grout into the joint. Follow

the grout manufacturer's instructions. Wipe off the excess grout before it sets with a sponge and water, taking care not to damage the joint and following the manufacturer's instructions. To remove any joint or cement residues use a cement remover as indicated by the manufacturer. Do not use white cement nor materials containing carbon black pigments.

#### HANDLING PORCELAIN TILES

**Cutting tiles.** Although ALCALAGRES porcelain tiles are much harder than standard ceramic tiles, you can cut them so that they fit into edges or corners. - For thin strips and central circles to fit tiles into edges, lights or pipes use a water-cooled diamond blade. - For straight cuts use a tile saw; there are many of them specific for porcelain gres. - For holes of all sizes to install pipes, traps, safety latches, etc., there are specific cutting tools. You will cut the holes easily and efficiently.

**Drilling tiles.** No special drill is required for drilling holes into tiles. However, they should meet the following requirements: - Power  $\geq$  600W. Select rotation, no hammer action mode. Drill bit holder  $\geq$ 10mm. Side-handle grip and depth stop. - Specialty drill bits with diamond or tungsten carbide tips that come in different shapes to suit all cutting applications. Follow the manufacturer's instructions.

For mor information, please, refer to our website:

[www.alcalagres.com](http://www.alcalagres.com)

## POSE RECOMMANDATIONS VERLEGUNGSVORSCHLÄGE

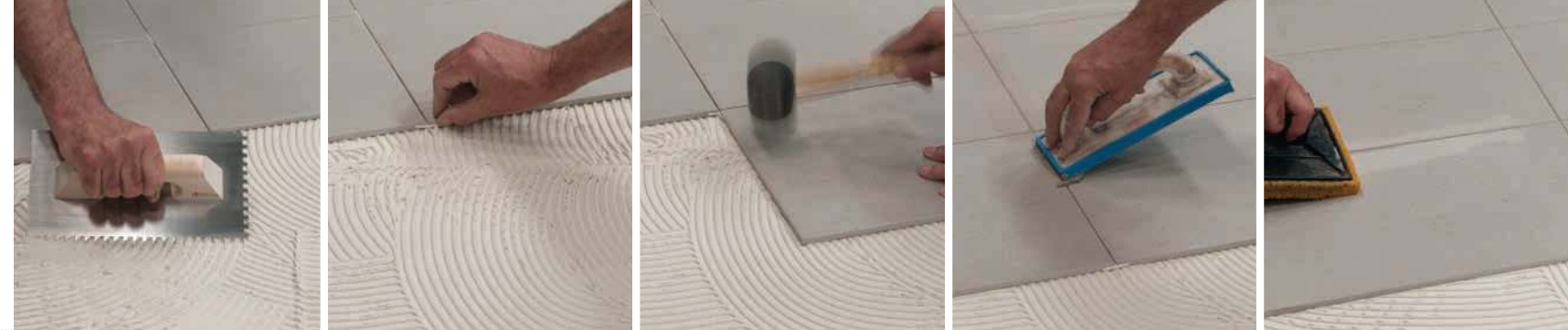

### FR

Un produit innovateur comme le grès porcelainé intégral ALCALAGRES demande l'utilisation de systèmes et de matériaux appropriés à sa pose. Sa bonne manipulation de la part des professionnels rehaussera la beauté de la finition finale et assurera sa durabilité, surtout dans les endroits très fréquentés. La pose de ce matériel devra être faite au moyen d'adhésifs-ciment (C2), d'adhésifs en dispersion (D2) ou d'adhésifs à réaction (R2), tous spécifiques au grès porcelainé et pour tous les revêtements en général, mais surtout pour les revêtements extérieurs et les grandes surfaces. Dans l'utilisation de ce type d'adhésifs, il conviendra de suivre à tout moment les indications du fabricant pour leur préparation et de bien vérifier qu'ils sont effectivement recommandés pour le grès porcelainé. Il existe sur le marché actuel une grande variété de marques parmi lesquelles vous pourrez choisir la meilleure. L'utilisation de mortiers traditionnels N'APPORTE PAS une adhérence suffisante.

En premier lieu, le professionnel de la pose devra vérifier que le matériau livré est conforme aux spécifications de la commande; ALCALAGRES, S.A. précise toujours sur ses emballages le modèle, la teinte et le calibre du produit et n'acceptera donc aucune réclamation concernant des matériaux déjà posés à cause d'éventuelles confusions. Certains modèles du catalogue d'ALCALAGRES comportent des différences de teinte et de design voulues dans la conception et la production, de la même manière que dans la nature, toutes les pierres sont différentes. Dans le cas de motifs d'avant-garde et personnalisés, il est recommandé de réaliser une planification préalable sur le sol sans adhésif pour anticiper le résultat final. On tiendra tout particulièrement compte du sens des veines et des motifs décoratifs de la surface des modèles en établissant au préalable le critère à suivre. Une fois que la couche de nivellement est prête, sèche et propre, poser le grès porcelainé intégral ALCALAGRES avec un bon mortier-colle spécifique pour ce matériau. Utiliser une truelle dentée de 6 mm pour les pièces 30x30 ou de dimensions inférieures ; pour des dimensions supérieures, utiliser une spatule dentée de 9 à 10 mm et si nécessaire, appliquer une seconde couche de colle (sur le support et au dos de la pièce) afin de renforcer l'adhésion au support. Il est extrêmement important de poser les pièces au même niveau, en évitant tout rebord ou dénivellation, pour obtenir une surface complètement plane. On recommande l'utilisation de maillets en caoutchouc blanc pour égaliser les pièces, les maillets foncés peuvent laisser des traces dont l'élimination requiert ensuite des produits spécifiques. Si vous travaillez avec des formats rectangulaires, nous vous recommandons de ne pas les poser en décalé en coupant à la moitié du carreau, mais à 1/4 ou à 1/5. Il est très important de respecter les temps de séchage in-

diqués par le fabricant de mortier-colle et de ne pas circuler sur le revêtement avant la fin du délai spécifié. Bien que le grès porcelainé intégral d'ALCALAGRES, S.A. soit résistant aux attaques chimiques et à l'abrasion, nous vous conseillons, une fois la pose terminée, de le protéger en vue des travaux ultérieurs à réaliser par le reste des corps de métier. Le matériau de jointoiement doit être approprié au grès porcelainé et à chaque type de pose, utilisation du sol ou conditions climatiques du site. Il devra être appliqué avec une truelle en caoutchouc dur pour assurer une bonne pénétration, en suivant dans tous les cas les instructions du fabricant (recommandations d'utilisation). Une fois le produit de jointoiement appliqué, ôter le surplus à l'aide d'une éponge imbibée d'eau propre avant qu'il ne durcisse, en faisant attention à ne pas endommager le joint et en suivant scrupuleusement les instructions du fabricant. Éliminer tout reste de mortier ou de joint en suivant scrupuleusement les indications du fabricant et avec les éléments préconisés par ce dernier. Ne pas utiliser de ciment blanc ordinaire ni de matériau de jointoiement contenant du « noir de fumée ».

#### MANIPULATION DU MATÉRIAU

**Découpe.** Bien que le grès porcelainé intégral ALCALAGRES se caractérise par sa grande dureté, il peut néanmoins être découpé pour effectuer la pose, afin de l'adapter à la géométrie de l'espace. - Les coupes à onglets et centrales pour appliques d'éclairage ou raccords de tuyaux devront être réalisées avec des disques-diamant réfrigérés à l'eau. - Les coupes droites seront facilement réalisées avec les machines ordinaires existant sur le marché et déjà adaptées à la découpe du grès porcelainé. - Pour les coupes circulaires de différents diamètres telles qu'entrées de tuyaux, siphons, fermetures de sécurité, etc., certains fabricants ont développé des outils de coupe spécifiques qui facilitent la découpe et permettent d'obtenir une finition satisfaisante.

**Perçage.** Pour percer le grès porcelainé une fois posé, il n'est pas nécessaire d'utiliser une perceuse spéciale ; il suffit qu'elle respecte un minimum de conditions : - Puissance  $\geq$  à 600W, sélecteur de mode sans percuteur (rotation), sélecteur de vitesses, porte-forets avec ouverture  $\geq$  10mm, poignée supplémentaire et butée de profondeur. - On recommande l'utilisation de forets spéciaux pour grès porcelainé en carbure de tungstène ou diamant, dont les différentes formes de pointe s'adaptent au type d'utilisation requise. Ici, comme dans tous les cas, nous suivons les spécifications indiquées par le fabricant pour chaque type d'utilisation.

Pour information additionnel, vous pouvez consulter notre page web: [www.alcalagres.com](http://www.alcalagres.com)

### DE

Für die Verlegung eines innovativen Produktes wie es das integrale Feinsteinzeug von ALCALAGRES ist, müssen auch geeignete Systeme und Materialien verwendet werden. Die korrekte Handhabung durch Spezialisten garantiert ein schönes Endergebnis und eine gute Haltbarkeit, vor allem wenn es an kollektiv genutzten Plätzen verlegt wird. Diese Fliesen müssen mit speziellen Zementklebern (C2), Dispersionsklebern (D2) oder Reaktionsklebern (R2) für Feinsteinzeug verlegt werden, vor allem Bodenfliesen im Außenbereich, große Flächen und Wandfliesen aller Art. Bei Verwendung von Klebern dieser Art müssen immer die Hinweise des Herstellers für deren Zubereitung beachtet werden und vor allem muss man sicherstellen, dass der Kleber wirklich für Feinsteinzeug empfohlen wird. Derzeit sind viele verschiedene Marken im Handel erhältlich, aus denen man die jeweils am besten geeignete aussuchen kann. Die Verwendung von traditionellem Mörtel gewährleistet KEINE ausreichende Haftung.

Zunächst hat der Fliesenleger zu prüfen, ob das gelieferte Material mit den Angaben in der Bestellung übereinstimmt; auf den Verpackungskartons von ALCALAGRES, S.A. ist immer das Modell, Farbton und Kaliber angegeben, daher werden Reklamationen wegen Verwechslung bei bereits verlegten Materialien nicht akzeptiert. ALCALAGRES offeriert in seinem Katalog auch Modelle mit einer beabsichtigten Farbabstufung beim Design und bei der Produktion, so dass jede Fliese unterschiedlich ist, so wie man auch Natursteine in der Natur vorfindet. Bei gewagten und personalisierten Entwürfen muss zunächst eine Probeverlegung auf dem Untergrund ohne Kleber durchgeführt werden, um das Endergebnis zu prüfen. Besonderes Augenmerk ist auf die Musterausrichtung und Abstimmung der Fliesenoberfläche zu legen, und es müssen von vornherein die zu befolgenden Kriterien festgelegt werden. Nachdem die Nivellierschicht aufgebracht, trocken und sauber ist, wird das Feinsteinzeug von ALCALAGRES mit einem guten Klebemörtel speziell für Feinsteinzeug verlegt. Verwenden Sie eine 6 mm-Zahnpachtel für Fliesen bis zu einer Größe von 30 x 30, und bei größeren Abmessungen eine Zahnpachtel mit 9 bis 10 mm Zahnung. Wenn nötig tragen Sie den Kleber doppelt auf (auf dem Untergrund und auf der Rückseite der Fliesen), damit wird die Haftung auf dem Untergrund erhöht. Achten Sie besonders darauf, die Fliesen sorgfältig zu nivellieren, um Kantenüberstände zu vermeiden und so eine vollkommen ebene Oberfläche zu erhalten. Es empfiehlt sich einen weißen Gummihammer zum Nivellieren der Fliesen zu verwenden, denn dunkle Hämmer hinterlassen Spuren, die danach mit Spezialreinigern entfernt werden müssen. Wenn rechteckige Formate verlegt werden, empfiehlt es sich diese nicht um die Hälfte versetzt zu legen sondern um 1/4 oder 1/5 der Fliese. Es ist sehr wichtig, die vom Hersteller angegebenen Trocknungszeiten für den Klebemörtel einzuhalten und den Bodenbelag

nicht vorher zu begehen. Obwohl das integrale Feinsteinzeug von ALCALAGRES, S.A. sowohl chemisch wie auch gegen Abrieb beständig ist, empfiehlt es sich den fertig verlegten Boden während der Durchführung der übrigen Arbeiten entsprechend zu schützen. Die Fugenmasse muss zum Verfugen von Feinsteinzeug geeignet sein; ebenso muss sie an die jeweilige Verlegungsart, die Verwendung des Bodens oder die klimatischen Umweltbedingungen angepasst sein. Sie sollte den Anweisungen des Herstellers folgend (Gebrauchsempfehlungen) mit einer Hartgummispachtel aufgetragen werden, um besser in die Fugen einzudringen. Nach dem Ausfügen der Fliesen, muss überschüssiges Material mit einem Schwamm und sauberem Wasser entfernt werden, bevor es hart wird. Dabei ist vorsichtig vorzugehen, um die Fuge nicht zu beschädigen und immer den Anweisungen des Herstellers zu folgen. Wo immer Reste von Klebemörtel oder Fugenmasse haften bleiben, müssen diese entsprechend den Anweisungen des Herstellers und mit den von diesem angegebenen Mitteln entfernt werden. Verwenden Sie weder normalen Weißzement noch Ruß enthaltendes Fugenmaterial.

#### VERARBEITUNG VON FEINSTEINZEUG

**Schneiden.** Das Feinsteinzeug von ALCALAGRES zeichnet sich durch seine große Härte aus. Dennoch kann es bei der Verlegung zugeschnitten werden, um es an die jeweilige Raumgeometrie anzupassen. - Gehrungen sowie Ausschnitte in der Mitte für die Anbringung von Beleuchtungskörpern oder Rohrleitungen müssen mit wassergekühlter Diamantscheibe durchgeführt werden. - Die geraden Schnitte, werden ganz einfach mit den gängigen, im Handel erhältlichen Maschinen zum Schneiden von Feinsteinzeug durchgeführt. - Für kreisrunde Ausschnitte unterschiedlicher Durchmesser wie etwa für den Durchgang von Rohren, Sifonen, Sicherheitsschlössern usw. haben die Hersteller spezielle Schneidelemente entwickelt, die das Durchführen solcher Schnitte erleichtern und ein zufriedenstellendes Ergebnis ermöglichen.

**Bohren.** Um in bereits verlegte Feinsteinzeugfliesen Löcher zu bohren, braucht man keinen Spezialbohrer. Es reicht, dass er folgende Voraussetzungen erfüllt: - Leistung  $\geq$  600W, Einstellung für nur Bohren, nicht Schlagbohren, Geschwindigkeitseinstellung, Bohrfutter mit einer Öffnung von  $\geq$  10mm, Zusatzhaltegriff und Tiefenanschlag. - Es wird empfohlen spezielle Bohrer aus Wolframcarbid oder Diamantbohrer für Feinsteinzeug zu verwenden, die je nach dem wofür sie benötigt werden, eine unterschiedliche Form der Bohrspitze aufweisen. Wie immer ist auch hier den Angaben des Herstellers für jeden Anwendungsfall Folge zu leisten.

Um diese Auskunft zu breiten, besuchen sie unsere Webseite: [www.alcalagres.com](http://www.alcalagres.com)

# Limpieza y mantenimiento

MAINTENANCE

NETTOYAGE ET MAINTENANCE

REINIGUNG u. PFLEGE

## ES

El Porcelánico Integral ALCALAGRES posee una belleza que puede quedar enmascarada una vez se ha terminado su instalación, las pequeñas acumulaciones de cemento que se han generado al instalarlo, si no se retiran a tiempo, pueden afectar de forma seria al resultado final, por lo que, una vez acabado el proceso de rejuntado y habiendo dejado un tiempo de espera prudencial para que el material de agarre y rejuntado se haya secado adecuadamente, se debe proceder a una primera limpieza.

La resistencia al ataque químico del gres porcelánico permite la limpieza de las superficies con detergentes concentrados, quita-cementos o desincrustantes, diluidos en agua o concentrados pero comprobando siempre que ningún producto que se emplee contenga Ácido fluorhídrico, ya que produce daños en el gres porcelánico y en cualquier otro material de origen cerámico. Estos limpiadores serán aplicados de la forma y en la concentración que detalle el fabricante en el envase, de igual manera hay que atender en todo momento las precauciones de uso que el fabricante determine.

Antes de proceder a la utilización del producto de limpieza sobre la superficie a limpiar, es recomendable probar sus efectos en un lugar poco visible o en una baldosa de las de reserva, dejar actuar el producto y observar sus efectos transcurrido un tiempo prudencial.

Uno de los productos probados y recomendados por ALCALAGRES S.A. para la primera limpieza es el limpiador KERANET de la firma MAPEI.

El porcelánico integral ALCALAGRES, no requiere ningún mantenimiento especial, para su limpieza diaria se puede utilizar agua muy caliente con un detergente neutro siempre siguiendo las indicaciones del fabricante del limpiador. Para los acabados antideslizantes se aconseja diluir ácido clorhídrico (agua fuerte) en agua para facilitar su limpieza. Con los acabados rústicos puede ser conveniente el empleo de un cepillo de fibra dura para extraer la suciedad que se acumule en su superficie rugosa.

Para grandes superficies se recomienda el empleo de máquinas industriales de limpieza con agua caliente. En ningún caso emplear ceras ni jabones aceitosos o coloreados y seguir instrucciones del fabricante de las máquinas con respecto al uso de detergentes.

El mantenimiento del porcelánico pulido requiere una mayor atención, especialmente con los colores lisos y claros, ya que el proceso del pulido altera ligeramente la porosidad con respecto al porcelánico natural.

El porcelánico integral pulido ALCALAGRES, se suministra con un protector de superficie que tiene como finalidad facilitar la limpieza de los diferentes productos usados en las obras de colocación. Para su limpieza diaria, es suficiente con una mopa ligeramente húmeda y recuperará perfectamente el brillo característico de la superficie pulida.

En caso de derramar cualquier líquido sobre el pavimento se recomienda actuar con diligencia. En zonas como talleres, bares, cocinas industriales, etc. se puede realizar la limpieza con productos específicos que ya existen en el mercado, y que facilitan la desaparición de marcas de goma, grasa, pintura... etc.,. Es importante conocer el origen de la mancha para utilizar el disolvente adecuado.

El uso de productos con componentes ácidos no ataca al porcelánico integral ALCALAGRES (excepto el ácido fluorhídrico) pero su empleo puede afectar a la seguridad de las personas y a otros elementos decorativos o constructivos, por lo que se deberán utilizar con precaución y siempre siguiendo las indicaciones del fabricante del producto químico. Se ha comprobado que la Sosa Cáustica concentrada depositada durante algún tiempo sobre el porcelánico integral altera el aspecto pulido de este material, pero no afecta a sus características técnicas. ALCALAGRES, S.A. no se hace responsable de los daños que estos productos puedan ocasionar en otros materiales diferentes al porcelánico integral.

Los complementos decorativos que contienen efectos de metal o cristal se deben tratar con cuidado tanto en su colocación como en su mantenimiento. Estos materiales no tienen las mismas cualidades técnicas que el porcelánico integral por lo que su comportamiento ante productos abrasivos físicos o líquidos pueden dañarlos. Tener especial cuidado al aplicar el material de rejuntado, limpiar inmediatamente con una bayeta o esponja suave muy humedecidas. Si se observan defectos en estas piezas, no colocarlas. No se aceptan reclamaciones de piezas ya colocadas.

En las entradas de locales de uso público es aconsejable instalar felpudos industriales, especialmente si el acceso es directo desde la calle. Con esta precaución se evitarán deslizamientos por "agua planning" y se conseguirá una mayor durabilidad del material, no obstante debemos destacar que ALCALAGRES, S.A. fabrica actualmente, multitud de modelos en acabado antideslizante clase 3 según la UNE-ENV 12633:2003, con los que las situaciones de peligro en las entradas de locales públicos quedan erradicadas.

## EN

ALCALAGRES porcelain tiles are a beautiful accent that can be overshadowed by cement chunks and grout spots left after flooring installation. If these are not removed in time, they can prevent the floor from showing its real beauty and thus affect the general appearance of the room. You have to wait for the grout to set and then clean the floor for the first time.

Since porcelain gres is resistant to chemical corrosion, it can be cleaned with strong detergents, concrete removers or descalers, but be sure you read the cleaning product's label carefully to check that it does not contain hydrogen fluoride, since it damages porcelain gres and other types of ceramic tiles. Follow the manufacturer's instructions and ratio suggestions.

Before applying the product on the whole floor, try it on a small area or on one of your extra tiles. Leave it for a while and see the final result. ALCALAGRES S.A. has tested and recommends KERANET from MAPEI for the first cleaning of your tile flooring.

ALCALAGRES integral porcelain tiles do not require special maintenance. Use very hot water and a neutral detergent in everyday cleaning. For anti-slip finishes it is recommended to dilute hydrochloric acid with water to facilitate the cleaning process. Use a hard-fibre brush on unfinished or textured finish and antiskid tiles to brush dust off their rouge surface.

Industrial cleaning machines that use hot water are ideal for large surface areas. Avoid wax polish, or oily or coloured soap and follow the machine manufacturer's instructions on what detergent you should choose.

Polished porcelain requires more careful maintenance, especially light coloured tiles, as polishing increases slightly the tiles' porosity as compared to unfinished tiles.

ALCALAGRES polished porcelain tiles have a surface protector that makes cleaning of laying materials easy. For everyday cleaning, water is a good mopping solution for the tiles, which will immediately show their characteristic brightness.

Address any spills immediately to avoid permanent stains.

To clean tiles installed in workshops, bars, industrial kitchens, etc. you can always buy commercial cleaners that remove rubber, grease, paint, etc. Knowing the origin of the stain helps decide which solvent you should apply to remove it.

Although acid products –except those containing hydrogen fluoride– do not affect ALCALAGRES porcelain gres, they can be unsafe for both people and decorative or structural objects. Use them with caution, following the manufacturers' instructions. Concentrated caustic soda on floor tiles can affect the look of the polished surface, even if it does not alter its basic properties. ALCALAGRES shall not be liable for any damages resulting from the use or application of products on materials other than porcelain gres.

Metal or glass decorative accessories should be handled with care during and after the tiling work. These materials do not feature the characteristics as porcelain gres, and thus abrasive products or corrosive chemicals can damage them. Apply grout carefully, clean immediately after completion of the work with a wet soft sponge or cloth. Do not fix defective accessories, as the company does not accept claims on fixed pieces.

Special doormats should be placed at the entrance of public buildings, especially if they can be accessed directly from the street. Doormats prevent aquaplaning water, dust, snow, etc. from entering the space, and thus they extend the durability of the tiles. However, ALCALAGRES S.A. manufactures a score of floor tiles of slow slip potential (UNE-ENV 12633:2003, Class 3) to avoid potentially dangerous situations at the entrance of public spaces.

## RECOMENDACIONES DE PRODUCTOS PARA LIMPIEZA Y MANTENIMIENTO

CLEANING AND MAINTENANCE PRODUCTS AND TIPS

RECOMMANDATIONS DE PRODUITS POUR LE NETTOYAGE ET LA MAINTENANCE TACHE PRODUIT CHIMIQUE DÉTERGENT

EMPFOHLENE PRODUKTE ZUR REINIGUNG u. PFLEGE FLECKENART CHEMISCHES PRODUKT REINIGER

MANCHAS STAIN TACHE ART DES FLECKS	PRODUCTO QUÍMICO COMPOUND PRODUIT CHIMIQUE CHEMISCHES PRODUKT	DETERGENTE DETERGENT DÉTERGENT REINIGER
<b>Tomate, Frutas, Chocolate y Salsas.</b> Tomato, fruit chocolate, sauce Tomate, Fruits, Chocolat et Sauces Tomaten, Obst, Schokolade und Soßen	<b>Amoniaco. Ácido Clorhídrico ClH 10%</b> Ammonia. hydrochloric acid (HCl) 10% Ammoniaque. Acide chlorhydrique ClH 10% Ammoniak; Salzsäure ClH 10%	<b>Detergente alcalino</b> Alkaline detergent Détergent alcalin Alkanischer Reiniger
<b>Grasa vegetal/animal. Cerveza., Helados, Café, Aceite de linaza y Vino.</b> Oil, grease, beer, ice cream, coffee, linseed oil, wine. Graisse végétale/animale, Bière, Glaces, Café, Huile de lin et Vin. Pflanzl./tierische Fette; Bier, Eis, Kaffee, Leinsamenöl und Wein	<b>Ácido Clorhídrico ClH 10% Potasio</b> HCl 10%, potassium. Acide chlorhydrique ClH 10% Potassium Salzsäure ClH 10% Kalium	<b>Detergente alcalino.</b> Alkaline detergent Détergent alcalin Alkanischer Reiniger
<b>Sangre</b> Blood Sang Blut	<b>Hipoclorotileno</b> Hypo-chlorite ethylene Hypochlorite de sodium Hypo-Chloräthylene	<b>Detergente alcalino</b> Alkaline detergent Détergent alcalin Alkanischer Reiniger
<b>Goma de zapato o Neumático</b> Rubber sole, tyre Gomme de chaussure ou pneumatique Gummisohlen oder Reifergummi	<b>Diluente nítrico, trielina..... Amoniaco. ClH 10%. Tricloro-etileno.</b> Nitric solvent, trichloroethylene, ammonia HCl 10% Diluant nitrique, térébenthine..... Ammoniaque. ClH 10%. Trichloréthylène. Salpetersaures Lösungsmittel, Waschbenzin... Ammoniak. ClH 10%. Trichloräthylene	<b>Disolvente orgánico</b> Organic solvent Dissolvant organique Organisches Lösungsmittel
<b>Aceites lubricantes, Lápiz y Betún</b> Huiles lubrifiantes, Crayon à papier et Cirage. Oxide et restes métalliques. Schmieröle, Bleistift und Schuhcreme.	<b>Tricloro-etileno. Acetona</b> Trichloroethylene, acetone Trichloréthylène. Acétone. Trichloräthylene. Aceton.	<b>Disolvente orgánico</b> Organic solvent Dissolvant organique Organisches Lösungsmittel
<b>Resinas y Laca de esmalte</b> Resin, lacquer Résines et Vernis à ongles Harze und Nagellack	<b>Agua regia, diluente nítrico. Tricloro-etileno. Acetona</b> Aqua regia, trichloroethylene, nitrous solvent, acetone Eau régale, diluant nitrique. Trichloréthylène. Acétone Königswasser, salpetersaures Lösungsmittel. Trichloräthylene. Aceton.	<b>Disolvente orgánico</b> Organic solvent Dissolvant organique Organisches Lösungsmittel
<b>Tintas</b> Ink Encres Tinte	<b>Solución diluida de hipoclorito de sodio. Ácido sulfúrico o nítrico.</b> Diluted sodium hypochlorite, sulphuric or nitric acid Solution diluée d'hypochlorite de sodium. Acide sulfurique ou nitrique. Verdünnte Natriumhypochlorit-Lösung. Schwefelsäure oder Salpetersäure.	<b>Detergente ácido</b> Acid detergent Dissolvant (dérivés du pétrole). Saures Reinigungsmittel
<b>Restos de cementos</b> <b>Efloreencias calcáreas</b> Cement chunk, calcareous efflorescence Restes de ciments Efflorescences calcaires Zementreste Kalkablagerungen	<b>ClH 10%</b> HCl 10% ClH 10% ClH 10%	<b>Detergente ácido</b> Acid detergent Détergent acide Saures Reinigungsmittel
<b>Óxido</b> Rust Rouille Rost	<b>ClH.Ácido Sulfúrico(H<sub>2</sub>SO<sub>4</sub>)</b> HCl, sulphuric acid (H <sub>2</sub> SO <sub>4</sub> ) ClH. Acide sulfurique (H <sub>2</sub> SO <sub>4</sub> ) ClH.Schwefelsäure (H <sub>2</sub> SO <sub>4</sub> )	<b>Detergente ácido</b> Acid detergent. Détergent acide Saures Reinigungsmittel
<b>Nicotina</b> Nicotine Nicotine Nikotin	<b>Ácido cítrico</b> Citric acid Acide citrique Zitronensäure	<b>Detergente ácido</b> Acid detergent Détergent acide Saures Reinigungsmittel

**MUY IMPORTANTE:** Esta tabla es sólo indicativa, ALCALAGRES, S.A. no es responsable del mal uso que se pueda hacer con los productos aquí recomendados. Se deberán seguir escrupulosamente las indicaciones de los envases. Se recomienda realizar una prueba en una pequeña zona. La Sosa Cáustica (NaOH) si se emplea pura puede alterar el aspecto del material pulido aunque no afecta a sus características técnicas. No emplear nunca productos que contengan Ácido Fluorhídrico. **IMPORTANT NOTICE:** This information is provided for guidance purposes only. ALCALAGRES S.A. shall not be liable for any damages resulting from the misuse of recommended products. Try the products first on a small area. Follow the manufacturer's instructions carefully. Caustic soda (NaOH) can change the appearance of polished tiles, not their technical characteristics. Avoid using products containing hydrogen fluoride. **TRES IMPORTANT:** Ce tableau est uniquement donné à titre indicatif. ALCALAGRES, S.A. ne sera pas tenu pour responsable de la mauvaise utilisation qui pourrait être faite des produits recommandés ici. L'utilisateur devra suivre scrupuleusement les indications figurant sur les emballages. Il est recommandé de faire un essai sur une petite surface. La soude caustique (NaOH) utilisée à l'état pur peut altérer l'aspect du matériau poli, mais pas ses caractéristiques techniques. Ne jamais utiliser de produits contenant de l'acide fluorhydrique. **SEHR WICHTIG:** Diese Tabelle dient nur zur Orientierung; ALCALAGRES, S.A. übernimmt keine Haftung für den unsachgemäßen Gebrauch der hier empfohlenen Produkte. Die Anwendungshinweise auf den Verpackungen sind strikt einzuhalten. Es wird empfohlen an einer unauffälligen Stelle eine Probe zu machen. Natronlauge (NaOH) kann, wenn sie pur verwendet wird, das Aussehen des polierten Materials verändern, ohne deshalb die technischen Merkmale zu beeinflussen. Verwenden Sie niemals Produkte die Fluorwasserstoffsäure enthalten.

## FR

Le grès porcelainé intégral ALCALAGRES possède une beauté qui peut perdre de son éclat une fois la pose terminée si les restes de ciment ne sont pas retirés à temps car ils peuvent affecter sérieusement le résultat final. Ainsi, une fois le jointoiement terminé et après avoir laissé un temps raisonnable pour le séchage adéquat du matériau de collage et de jointoiement, il convient de procéder à un premier nettoyage.

La résistance du grès porcelainé aux attaques chimiques permet le nettoyage des surfaces avec des détergents concentrés et des produits spéciaux pour enlever le ciment ou désincrustants, dilués dans l'eau ou concentrés, mais en faisant bien attention à ce qu'aucun des produits employés ne contienne d'acide fluorhydrique, très agressif pour le grès porcelainé et tout autre matériau d'origine céramique. Ces produits nettoyeurs seront appliqués sous la forme et suivant la concentration indiqués par le fabricant sur l'emballage, en veillant à tout moment à respecter les précautions d'utilisation préconisées. Avant de procéder à l'utilisation du produit de nettoyage sur la surface à nettoyer, il est recommandé de faire un essai sur un endroit peu visible ou sur un carreau de réserve, de laisser le produit agir et d'observer ses effets passé un délai raisonnable. Un des produits testés et recommandés par ALCALAGRES S.A. pour le premier nettoyage est le nettoyeur KERANET de la firme MAPEI.

Le grès porcelainé intégral ALCALAGRES n'exige aucun entretien particulier. Pour son nettoyage quotidien, on utilisera de l'eau très chaude et un détergent neutre, en suivant toujours les indications du fabricant du produit. Pour les finitions antidérapantes nous conseillons de diluer acide chlorhydrique avec de l'eau pour faciliter le nettoyage. Pour les finitions rustiques et antidérapantes, il convient d'utiliser une brosse à crins durs pour extraire les saletés qui s'accumulent sur la surface rugueuse.

Pour les grandes surfaces, on utilisera des machines industrielles de nettoyage à eau chaude. Ne jamais utiliser de cires ni de savons huileux ou colorés et suivre les instructions du fabricant des machines concernant l'usage de détergents.

L'entretien du grès porcelainé poli requiert quant à lui un peu plus de soin, notamment dans le cas des couleurs unies et claires, étant donné que l'opération de polissage altère légèrement la porosité par rapport au grès porcelainé naturel.

Le grès porcelainé intégral poli ALCALAGRES est fourni avec un protecteur de surface qui a pour but de faciliter le nettoyage

des différents produits utilisés lors des opérations de pose. Pour l'entretien quotidien, une serpillère légèrement humide suffira pour rendre aux surfaces polies tout l'éclat qui les caractérise.

Si un liquide quelconque se répandait sur le revêtement, nous vous recommandons d'agir avec célérité et précaution.

Dans des zones telles qu'ateliers, bars, cuisines industrielles, etc., le nettoyage peut être réalisé avec des produits spécifiques existant déjà sur le marché, qui facilitent en plus l'élimination des traces de caoutchouc, graisse, peinture, etc. Il est important de connaître l'origine de la tache afin d'utiliser le dissolvant approprié.

Les produits contenant des composants acides n'entament pas le grès porcelainé intégral ALCALAGRES (excepté l'acide fluorhydrique) mais ils peuvent toutefois être dangereux pour les personnes et abîmer d'autres éléments décoratifs ou constructifs ; ils devront donc être utilisés avec précaution et en suivant à tout moment les indications du fabricant du produit chimique. Des essais ont prouvé que la soude caustique concentrée et déposée pendant un certain temps sur le grès porcelainé intégral altère l'aspect poli du matériau mais pas ses caractéristiques techniques. ALCALAGRES, S.A. ne sera pas tenu pour responsable des dommages que ces produits pourraient causer sur des matériaux autres que le grès porcelainé intégral.

Les compléments décoratifs contenant des effets de métal ou de verre/cristal doivent être traités avec le plus grand soin, aussi bien lors de la pose que durant la maintenance. Ces matériaux ne possèdent pas les mêmes qualités techniques que le grès porcelainé intégral et l'emploi de produits abrasifs physiques ou liquides pourrait les endommager. Faire particulièrement attention lors de l'application du matériau de jointoiement, nettoyer immédiatement avec un chiffon ou éponge douce imbibée d'eau. En cas de défauts visibles sur certaines pièces, nous vous recommandons de ne pas les poser. Aucune réclamation concernant des pièces déjà posées ne sera acceptée.

Des paillasons industriels devront être placés à l'entrée des établissements publics, surtout si l'accès donne directement sur la rue. Cette mesure servira à éviter les glissements et permettra en outre d'assurer une plus longue durée de vie au matériau. Remarquons toutefois qu'ALCALAGRES, S.A. fabrique actuellement une multitude de modèles à finition antidérapante, classe 3 suivant l'UNEENV 12633:2003, qui permettent d'éliminer les situations à risque à l'entrée des établissements publics.

## DE

Unmittelbar nach der Verlegung kommt die Schönheit des integralen Feinsteinzeugs von ALCALAGRES oft nicht gleich zur Geltung. Kleine Zementansammlungen, die sich eventuell bei der Verlegung gebildet haben, können eine schlimme Wirkung auf das Endergebnis haben, wenn sie nicht rechtzeitig entfernt werden. Daher muss man nach dem Verfugen und nach einer angemessenen Wartezeit, damit das Klebematerial und die Fugenmasse gut trocknen kann, eine erste Reinigung vornehmen. Da das Feinsteinzeug chemisch sehr beständig ist, können die Oberflächen mit in Wasser verdünnten oder konzentrierten Reinigungskonzentraten, Zemententfernern oder Entzunderungsmitteln gereinigt werden, wobei man immer darauf achten muss, dass keines der verwendeten Produkte Fluorwasserstoffsäure enthält, da solche Produkte das Feinsteinzeug sowie jedes andere Material keramischen Ursprungs angreifen. Die Reiniger werden in der vom Hersteller auf der Packung angegebenen Form und Konzentration verwendet. Auch ist immer den vom Hersteller angegebenen Vorsichtsmaßnahmen bei der Verwendung der Reiniger Folge zu leisten.

Bevor man den Reiniger auf die zu reinigende Oberfläche aufträgt, empfiehlt es sich eine Probe an einer unauffälligen Stelle oder auf einer Reservefliese durchzuführen, das Produkt einwirken zu lassen und nach einer gewissen Zeit das Ergebnis zu überprüfen.

Eines der von ALCALAGRES S.A. für die erste Reinigung erprobten und empfohlenen Produkte ist der Reiniger KERANET der Firma MAPEI.

Das integrale Feinsteinzeug von ALCALAGRES benötigt keine spezielle Instandhaltung. Für die tägliche Reinigung kann sehr heißes Wasser mit einem neutralen Reinigungsmittel, wie immer entsprechend den Angaben des Herstellers des Reinigers verwendet werden. Um die Reinigung des trittsicheren Ausfertigungen, würden wir Ihnen im Wasser auflösenden Salzsäure zu empfehlen. Bei rustikalen und rutschfesten Ausführungen ist eventuell die Verwendung einer Hartfaserbürste angebracht, um den Schmutz, der sich in der rauhen Oberfläche ansammelt, zu entfernen.

Bei großen Oberflächen empfiehlt sich die Verwendung von industriellen Reinigungsmaschinen mit heißem Wasser. Es dürfen keinesfalls Wachse oder ölhaltige oder farbige Seifen verwendet werden. Den auf den Maschinen angegebenen Anweisungen des Herstellers betreffend die Verwendung von Reinigungsmittel ist immer Folge zu leisten.

Die Instandhaltung polierten Feinsteinzeugs erfordert ein größeres Augenmerk, vor allem bei hellen und einheitlichen Farben, da beim Polieren die Porosität gegenüber unpoliertem Feinsteinzeug leicht verändert wird.

Das polierte integrale Feinsteinzeug von ALCALAGRES wird mit einer Schutzfolie geliefert, damit die bei der Verlegung durch die verwendeten Produkte verursachten Verunreinigungen leichter entfernt werden können. Für die tägliche Reinigung reicht ein leicht angefeuchteter Schwamm, um den charakteristischen Glanz der polierten Oberfläche wieder hervorzuheben.

Falls eine Flüssigkeit auf den Boden geschüttet wird, sollte diese rasch beseitigt werden.

In Werkstätten, Bars, Industrieküchen usw. kann eine Reinigung mit Spezialmitteln vorgenommen werden, die bereits im Handel erhältlich sind und die Entfernung von Gummi-, Fett-, Farbspuren usw. erleichtern. Das Wissen um die Herkunft eines Flecks ist wichtig, damit man das geeignete Lösungsmittel anwenden kann.

Die Verwendung von säurehaltigen Produkten stellt keine Gefahr für das integrale Feinsteinzeug von ALCALAGRES dar (ausgenommen der Fluorwasserstoffsäure), aber solche Produkte können die Sicherheit der Personen und anderer dekorativer oder baulicher Elemente gefährden, weshalb diese stets mit höchster Sorgfalt und immer entsprechend den Anweisungen des Herstellers des chemischen Produktes zu verwenden sind. Weiters hat man festgestellt, dass konzentrierte Natronlauge, nach einer gewissen Zeit auf dem Feinsteinzeug dessen poliertes Aussehen verändert, ohne jedoch seine technischen Merkmale zu ändern. ALCALAGRES, S.A. haftet nicht für Schäden, die diese Produkte an anderen Materialien verursachen können. Dekorative Elemente, die Metall- oder Glaseffekte beinhalten, müssen sorgsam behandelt werden, sowohl bei deren Verlegung, als auch bei der Instandhaltung. Diese Materialien haben nicht die gleichen technischen Merkmale wie das Feinsteinzeug und daher können sie durch physische oder flüssige Scheuermittel angegriffen werden. Mit besonderer Sorgfalt ist bei der Verteilung der Fugenmasse vorzugehen. Reste sind sofort mit einem sehr stark angefeuchteten Schwamm oder weichen Tuch zu entfernen. Wenn Sie Materialfehler bemerken, die entsprechende Fliese nicht verlegen. Es werden keine Reklamationen für bereits verlegte Fliesen angenommen.

An den Eingängen in öffentliche Lokale empfiehlt sich die Anbringung industrieller Fußmatten, wenn der Zugang direkt von der Straße her erfolgt. Diese Vorsichtsmaßnahme verhindert das Ausrutschen durch Aquaplaning und sichert eine längere Haltbarkeit des Materials. Allerdings muss hinzugefügt werden, dass ALCALAGRES, S.A. derzeit auch zahlreiche Modelle in rutschfester Ausführung der Klasse 3 nach der Norm UNE-ENV 12633:2003 herstellt, womit Gefahrensituationen an den Eingängen zu öffentlichen Lokalen ausgeschaltet werden.



# Información de interés

NOTES  
INFORMATION COMPLÉMENTAIRE  
INFORMATIONEN



## ■ ES

Dado el origen natural de las materias primas que integran el gres porcelánico, se producen pequeñas variaciones cromáticas y dimensionales en las baldosas durante el proceso de fabricación, antes de su encajado, alcalagres las selecciona rigurosamente por tono y calibre según establecen los procedimientos de ensayo de las normas UNE en 14411 (ISO 13006) y ANSI A 137.1. El material que se suministra según dichas normas no podrá ser objeto de reclamación.

Alcalagres se compromete al suministro de sus materiales unificados de calibre por formato; lo que permite combinaciones del mismo formato, pero con diferentes acabados. En el material procedente de diferentes fabricaciones no es posible suministrar una tonalidad idéntica, por lo que pueden existir pequeñas variaciones de tonos entre el producto presentado en exposiciones y muestrarios, y el suministrado. En ciertas ocasiones dichas variaciones de tono pueden manifestarse entre las piezas especiales y el material principal, por proceder de distintas partidas de fabricación.

Los modelos de ciertas series son fabricados de forma intencionada con una ligera discontinuidad en la intensidad de sus colores y decoración, tal y como se encuentran en la naturaleza. La diversidad de estas vetas debe ser aceptada por el cliente y no dará lugar a reclamación.

No se recomienda colocar el material a matajunta, rompejunta o trabado a la mitad de su longitud. Así mismo, el material de rejunte ha de ser específico para porcelánico, no se debe emplear cemento blanco ni materiales que contengan negro humo.

Las piezas con decoración de metal o cristal deben ser tratadas con cuidado durante su colocación y limpieza, ya que estas partes no tienen la misma resistencia y características que el resto del porcelánico. Por exigencias de producción, alcalagres se reserva el derecho de introducir modificaciones en sus productos sin previo aviso. Los colores de las fotografías de modelos presentados en este catálogo pueden variar ligeramente respecto al material suministrado. Toda la información que contiene este catálogo ha sido escrupulosamente revisada, no obstante no tiene valor contractual. El departamento técnico y comercial de alcalagres atenderá gustosamente cualquier solicitud de información adicional que se le formule.

## ■ EN

Because of the natural origins of the raw materials that form the porcelain ceramic tile, slight chromatic and dimensional variations may occur during the production process. ALCALAGRES rigorously selects corresponding tones and caliber according to the testing procedures of ISO-13006 and ANSI A 137.1 standards prior to packing. ALCALAGRES undertakes to supply materials with the same calibre for each format, thus permitting combinations of the same format, with different finishes.

Industry standards consider such variations to be normal. Variations in tone may exist between products from different batches and between products displayed in exhibitions and sample books and the material supplied. In addition, tonal variations may exist between special pieces and the tile sourced from different batches. Models in some series are intentionally manufactured with slightly uneven colour tones and decoration, like nature itself. The diversity of these veins must be accepted by the customer, and no returns will be accepted. Rectangular tiles should be staggered to a maximum of 1/4 or 1/5 of the length of the tile. Only grout recommended for porcelain tiles should be used, do not use white cement nor materials containing carbon black pigments. Decorated tiles that include metal or glass must be treated with care when laid or cleaned, because the surface does not have the same resistance or characteristics as the rest of porcelain tiles. For production reasons ALCALAGRES reserves the right to make modifications to its products, without the need for any prior notice. Because of the demands of its production process, ALCALAGRES reserves the right to modify its products without prior warning. The colours in the photographs presented in this catalogue may vary slightly from the real product. While ALCALAGRES has made every effort to ensure that the information herein is correct, the company assumes no responsibility for errors. The Technical and Commercial Departments of ALCALAGRES will be pleased to respond to all requests for further information. Products that are perfect for the most demanding projects where importance is given to design.

## ■ FR

Compte tenu de l'origine naturelle des matières premières qui composent notre grès cérame, de légères variations chromatiques et dimensionnelles se produisent sur les dalles pendant le processus de fabrication. Avant leur conditionnement, ALCALAGRES S.A. les classe rigoureusement par tons et par calibres comme le stipulent les procédures d'essai des normes UNE EN 14411 (ISO-13006) et ANSI A137.1. Le matériel sélectionné selon ces normes ne pourra pas faire l'objet de réclamations. ALCALAGRES S.A. s'engage à livrer ses matériaux en garantissant l'uniformité de leurs calibres et formats, ce qui permet de combiner des pièces d'un même format mais de finitions différentes. Pour le matériel procédant de différentes fabrications, il est impossible de fournir des tons identiques. Par conséquent il peut exister de légères variations de ton entre le produit présenté dans les expositions, les échantillons et celui fourni au client. Ces variations de ton peuvent aussi se manifester entre les pièces spéciales et le matériel principal quand ceux-ci proviennent de différents lots de fabrication. Les modèles de certaines séries sont intentionnellement fabriqués avec une légère discontinuité d'intensité des couleurs et de la décoration, comme cela se produit dans la nature. La diversité de ces veines doit être acceptée par le client, et aucune réclamation ne sera admise à cet égard. Il n'est pas conseillé de poser les formats rectangulaires en réalisant des joints décalés à la moitié de leur longueur. Les pièces à décoration en métal ou en verre doivent être manipulées avec le plus grand soin pendant la pose et le nettoyage, car ces pièces ne possèdent pas la même résistance ni les caractéristiques des autres produits en grès cérame. La pose à joint coupé des formats rectangulaires n'est pas conseillée. Pour des exigences de production, ALCALAGRES S.A. se réserve le droit d'introduire des modifications dans ses produits sans avis préalable. Les couleurs des photographies des modèles présentés dans ce catalogue peuvent varier légèrement par rapport aux matériaux fournis. Toute l'information contenue dans ce catalogue a été scrupuleusement révisée, néanmoins elle n'a aucune valeur contractuelle. Le Département Technique et Commercial d'ALCALAGRES S.A. répondra volontiers à toute demande d'information complémentaire qui lui sera adressée.

## ■ DE

Da die Rohstoffe von Feinsteinzeug natürlichen Ursprungs sind, können bei der Herstellung der Fliesen kleinere Unterschiede bei der Farbe und den Abmessungen auftreten. Vor der Verpackung prüft ALCALAGRES rigoros alle Produkte auf Farbtöne, Kaliber, so wie es die ISO-Norm en14411, 13006 und ANSI A 137.1 bezüglich der Prüfverfahren vorschreiben. Das Material, das nach diesen Kriterien geliefert wird, kann nicht Gegenstand von Beanstandungen sein. ALCALAGRES verpflichtet sich zur Lieferung seiner Materialien mit einheitlichem Kaliber pro Format, Kombinationen des gleichen Formats, jedoch mit verschiedenen Ausführungen möglich sind. Dass kleinere Punkte in anderer Farbe vorhanden sind. Diese werden nach den Prüfverfahren für diese Produktarten als normal angesehen. Bei Material aus unterschiedlichen Produktionen ist es nicht möglich gleiche Tonalitäten zu liefern. Dadurch können kleinere Unterschiede zwischen den Tönen der ausgestellten Produkte in Ausstellungen und Ausstellern und den Lieferungen entstehen. Unter gewissen Umständen können solche Farbtonunterschiede auch zwischen Sonder- und Grundteilen entstehen, da diese aus unterschiedlichen Produktionseinheiten stammen. Die Modelle bestimmter Serien sind absichtlich mit einer leichten Ungleichmäßigkeit ihrer Farbtintensität und Dekoration hergestellt-eben so, wie sich auch in der Natur vorkommen. Die Verschiedenartigkeit dieser Maßerungen muss vom Kunden angenommen werden und stelle kleinen Beanstandungsgrund dar. Wir empfehlen rechteckige Formate nicht im Halbverband zu verlegen. Es ist ebenso zu beachten, dass Fugenmasse zum Verfugen von Feinsteinzeug geeignet sein muss. Verwenden Sie weder normalen Weißzement noch Ruß enthaltendes Fugenmaterial. Fliesenteile mit Metall-oder Glasdekor müssen während des Verlegens und der Reinigung sorgfältig behandelt werden, da diese Teile nicht dieselbe Widerstandsfähigkeit und die Eigenschaften des übrigen Feinsteinzeugs haben. Aus Produktionsgründen behält sich ALCALAGRES das Recht vor, ohne Vorankündigungen Änderungen bei den Produkten vorzunehmen. Die Farben der abgebildeten Modelle in diesem Katalog können sich leicht von denen des gelieferten Materials unterscheiden. Alle Informationen in diesem Katalog wurden genauestens geprüft, haben aber dennoch keinerlei Vertragswert. Die technische Abteilung sowie die Verkaufsabteilung von ALCALAGRES stehen Ihnen gerne für alle weitere Fragen zur Verfügung.



Ctra. de Alcalá de Henares a Camarma, km. 4,1, 28816 Camarma de Esteruelas. Madrid (Spain)  
T. +34 91 886 59 20 · F. +34 91 885 76 35 · [www.alcalagres.com](http://www.alcalagres.com)

