

---

20  
15

---

#MY  
ABK

THIS COPY BELONGS TO: .....



---

#MMY

ABK

---

# 20 15

---

Oggi più che mai ABK è tutta TUA.

La nostra passione ci ha portato a selezionare le migliori espressioni della ceramica contemporanea, pensate per essere quotidianamente al servizio della TUA creatività.

Today more than ever ABK is all YOURS.

Our passion has led us to select the best expressions of contemporary ceramics, designed to be daily serving YOUR creativity.

---

20  
15

#MY  
ABK

ABK è da oltre 20 anni sinonimo di estetica e creatività, ancora oggi le nostre superfici devono prima di tutto “emozionare”. Per questo il catalogo 2015 è pensato come un contenitore di idee aperto alle contaminazioni stilistiche provenienti da moda, architettura e arredo. L’innovazione e la ricerca si uniscono ad uno stile personale per trasformare il prodotto ceramico in soluzioni dal design esclusivo e tecnologicamente all’avanguardia.

ABK is over 20 years synonym for aesthetics and creativity, even today our surfaces must first “excite”. For this reason the catalogue 2015 is designed as a container of ideas open to the stylistic influences from fashion, architecture and furniture. Innovation and research combine with a personal style to transform ceramic product in exclusive design solutions and technologically advanced.

FO

# 20

---

## TECHNOLOGY

ABK si rinnova proponendo nuove metodologie industriali attraverso soluzioni rivoluzionarie in grado di semplificare l'utilizzo anche dei grandi formati, trasporto, maneggevolezza, posa.

ABK is renewed offering new manufacturing methodologies through revolutionary solutions that allow to simplify the use, transport, handling and installation even of the large sizes.

# 40

---

## CUSTOM MADE

ABK propone collezioni complete che sono parte integrante di un progetto globale sui materiali e permettono soluzioni sempre diverse e molto personalizzate. Una vasta scelta di finiture, colori, formati, decorazioni e pezzi speciali, consentono di rifinire ogni progetto con cura sartoriale.

ABK offers complete collections that are integrant part of a global project on materials and allow different and very personalized solutions. A wide choice of finishes, colors, sizes, decorations and special pieces allow to finish each project with fine tailoring.

# 30

---

## ECO-FRIENDSHIP

Per migliorare la qualità della vita e il rispetto dell'ambiente nell'ottica di un'edilizia sostenibile, ABK ha messo a punto l'esclusivo impasto ceramico ECO-BODY, composto al 40% minimo da materiale riciclato recuperato da altre lavorazioni industriali. ECO-BODY è ufficialmente certificato LEED.

To improve the quality of life and the respect for the environment in perspective of a sustainable eco-building, ABK has developed the exclusive ceramic mixture ECO-BODY, made with a 40% minimum pre-consumer recycled material from other industrial processes. ECO-BODY is officially certified LEED.

20  
15

_____	262	AQUA
_____	274	ATELIER
_____	150	CABANE
_____	74	DOCKS
_____	114	DOLPHIN
_____	56	DOWNTOWN
_____	104	EVOLUTION
_____	164	FOSSIL
_____	178	GRACE PAV.
_____	238	GRACE RIV.
_____	206	JERUSALEM
_____	290	LEVEL
_____	252	MARBLEWAY
_____	94	PAPIER PAV.
_____	222	PAPIER RIV.
_____	188	PETRAIA
_____	296	PLAY WOOD
_____	30	RE-WORK
_____	230	SECRET
_____	132	SOLERAS
_____	10	UNIKA
_____	280	VELVET
_____	268	VISION
_____	158	WOODWAY 90
_____	302	WOODWAY 60
_____	214	ZANZIBAR PAV.
_____	284	ZANZIBAR RIV.

## INDEX BY SIZE

## INDICE PER FORMATO

GRES PORCELLANATO PAVIMENTI E RIVESTIMENTI  
PORCELAIN STONEWARE FLOOR & WALL TILESRIVESTIMENTI CONTEMPORANEI  
CONTEMPORARY WALL TILES

<b>40x170</b>	DOLPHIN	114
	SOLERAS	132

<b>20x170</b>	DOLPHIN	114
	SOLERAS	132

<b>60x120</b>	UNIKA	10
---------------	-------	----

<b>30x120</b>	UNIKA	10
---------------	-------	----

<b>20x120</b>	DOLPHIN	114
	SOLERAS	132

<b>41,5x81</b>	RE-WORK	30
----------------	---------	----

<b>80x80</b>	DOCKS	74
	DOWNTOWN	56
	RE-WORK	30

<b>40x80</b>	DOCKS	74
	DOWNTOWN	56
	FOSSIL	164
	RE-WORK	30
	UNIKA	10

<b>20x80</b>	CABANE	150
	DOCKS	74
	DOWNTOWN	56
	FOSSIL	164
	SOLERAS	132
	RE-WORK	30

<b>13,5x80</b>	CABANE	150
	SOLERAS	132

<b>15x90</b>	WOODWAY 90	158
--------------	------------	-----

<b>60x60</b>	DOCKS	74
	DOWNTOWN	56
	EVOLUTION	104
	GRACE	178
	SOLERAS	132
	PAPIER	94
	RE-WORK	30
	UNIKA	10

<b>30x60</b>	DOCKS	74
	DOWNTOWN	56
	EVOLUTION	104
	FOSSIL	164
	RE-WORK	30
	UNIKA	10

<b>15x60</b>	DOCKS	74
	UNIKA	10

<b>50x50</b>	EVOLUTION	104
	FOSSIL	164
	JERUSALEM	206
	PETRAIA	188
	ZANZIBAR	214

<b>33,3x50</b>	EVOLUTION	104
	JERUSALEM	206

<b>16,65x50</b>	EVOLUTION	104
-----------------	-----------	-----

<b>33,3x33,3</b>	EVOLUTION	104
	JERUSALEM	206
	MARBLEWAY	252
	PETRAIA	188
	VELVET	280
	ZANZIBAR	214

<b>16,65x33,3</b>	PETRAIA	188
-------------------	---------	-----

<b>16,65x16,65</b>	JERUSALEM	206
	PETRAIA	188

<b>11x33,3</b>	EVOLUTION	104
----------------	-----------	-----

<b>25x25</b>	PETRAIA	188
--------------	---------	-----

<b>30x30</b>	DOWNTOWN	56
--------------	----------	----

<b>10x30</b>	UNIKA	10
--------------	-------	----

<b>20x40</b>	RE-WORK	30
	UNIKA	10

<b>7x28</b>	DOLPHIN	114
-------------	---------	-----

<b>20x20</b>	RE-WORK	30
	UNIKA	10

<b>10x10</b>	JERUSALEM	206
	PETRAIA	188

<b>30x75</b>	GRACE	238
	PAPIER	222
	SECRET	230

<b>33,3x60</b>	MARBLEWAY	252
----------------	-----------	-----

<b>20x60</b>	AQUA	262
	VISION	268

<b>25x50</b>	ATELIER	274
	VELVET	280

<b>20x50</b>	ZANZIBAR	284
--------------	----------	-----

## BUILDING SOLUTIONS

<b>20,2x80,2</b>	PLAY WOOD	296
------------------	-----------	-----

<b>60x60</b>	LEVEL	290
--------------	-------	-----

<b>30x60</b>	LEVEL	290
--------------	-------	-----

<b>15x60</b>	WOODWAY 60	302
--------------	------------	-----



---

20  
15

---

#MY  
ABK

|

G R E S P O R C E L L A N A T O  
P A V I M E N T I E R I V E S T I M E N T I

PORCELAIN STONEWARE  
FLOOR & WALL TILES

---

_____	10	UNIKA
_____	30	RE-WORK
_____	56	DOWNTOWN
_____	74	DOCKS
_____	94	PAPIER
_____	104	EVOLUTION
_____	114	DOLPHIN
_____	132	SOLERAS
_____	150	CABANE
_____	158	WOODWAY 90
_____	164	FOSSIL
_____	178	GRACE
_____	188	PETRAIA
_____	206	JERUSALEM
_____	214	ZANZIBAR

---

# UNIKA

## GRES PORCELLANATO A MASSA COLORATA

FULL BODY COLOURED PORCELAIN STONEWARE

CLASSIFICAZIONE SECONDO NORME  
UNI EN 14411 (ISO 13006) ALLEGATO G-Gruppo Bla  
CLASSIFICATION IN ACCORDANCE  
WITH UNI EN 14411 (ISO 13006) ANNEX G-Group Bla

## SUPERFICI E FINITURE

SURFACES AND FINISHES

Naturale rettificato / Natural rectified  
Antique rettificato / Honed rectified  
Bocciardato / Structured

## FORMATI

SIZES

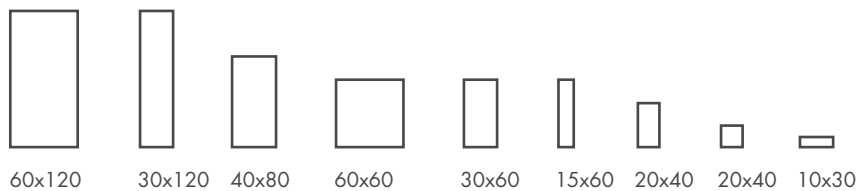

60x120  
MIX FLOOR

60x80  
MIX WALL

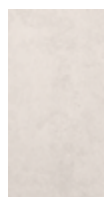

CREAM



ECRU



BRONZE



GREY

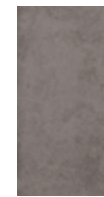

SMOKE









**UNIKA**

CREAM





60x120 ☞ 2  
 UNIKA CREAM  
**UKR3405A** rett. F 68,90  
**UKL3405A** ANTIQUE rett. F 81,90

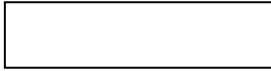

30x120 ☞ 4  
 UNIKA CREAM  
**UKR57050** rett. F 68,90

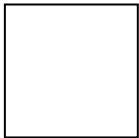

60x60 ☞ 3  
 UNIKA CREAM  
**UKN01050** nat. F 46,90  
**UKR01050** rett. F 53,90  
**UKL01050** ANTIQUE rett. F 64,90

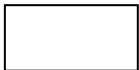

30x60 ☞ 6  
 UNIKA CREAM  
**UKR03050** rett. F 49,90



10x30 ☞ 18  
 UNIKA CREAM  
**UKR11050** rett. F 64,90

MIX FLOOR 60x120

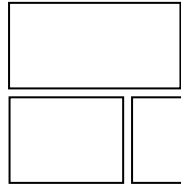

Nella confezione:  
 60x120 ☞ 1  
 60x80 ☞ 1  
 60x40 ☞ 1

60x120 ☞ 2  
 UNIKA CREAM MIX FLOOR  
**UKR3406A** rett. F 81,90

MIX WALL 60x80

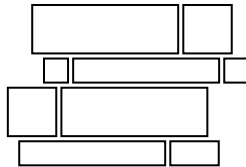

Nella confezione:  
 20x60 ☞ 4  
 20x20 ☞ 4  
 10x60 ☞ 4  
 10x20 ☞ 2  
 10x10 ☞ 4

60x80 ☞ 2  
 UNIKA CREAM MIX WALL  
**UKR20050** rett. F 74,90

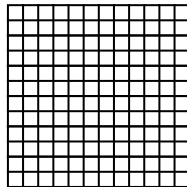

30x30 ☞ 4  
 MOS. OPUS MINI CREAM  
**UKR09052** rett. F 252,90

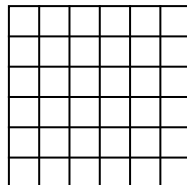

30x30 ☞ 6  
 MOS. QUADRETTI CREAM  
**UKR09051** rett. F 101,90

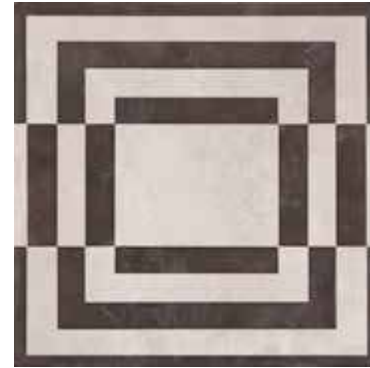

60x60 ☞ 2  
 DEC. LINK CREAM  
**UKR01055** rett. PZ 101,90

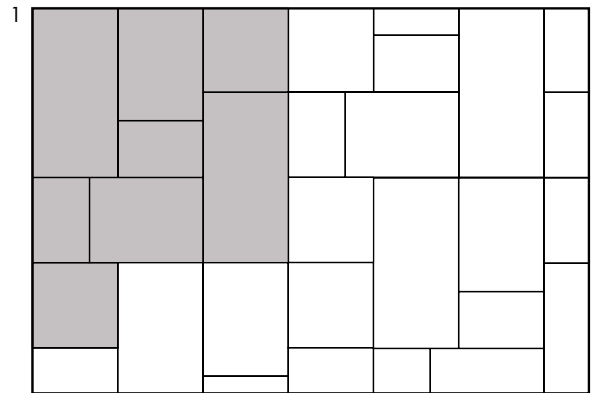

60x120 MIX FLOOR 80 %  
 60x60 20 %

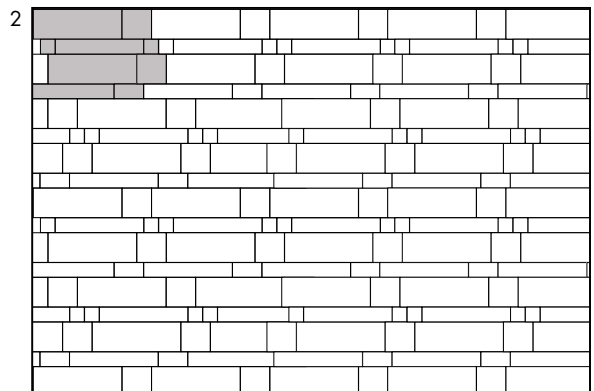

60x80 MIX WALL 100 %



**UNIKA**

ECRU



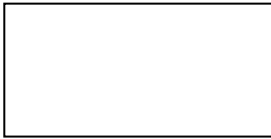

60x120 ☞ 2  
 UNIKA ECRU  
**UKR3410A** rett. F 68,90  
**UKL3410A** ANTIQUE rett. F 81,90

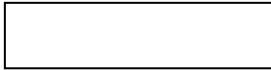

30x120 ☞ 4  
 UNIKA ECRU  
**UKR57100** rett. F 68,90

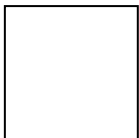

60x60 ☞ 3  
 UNIKA ECRU  
**UKN01100** nat. F 46,90  
**UKR01100** rett. F 53,90  
**UKL01100** ANTIQUE rett. F 64,90

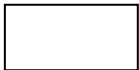

30x60 ☞ 6  
 UNIKA ECRU  
**UKR03100** rett. F 49,90



10x30 ☞ 18  
 UNIKA ECRU  
**UKR11100** rett. F 64,90

MIX FLOOR 60x120

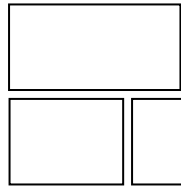

Nella confezione:  
 60x120 ☞ 1  
 60x80 ☞ 1  
 60x40 ☞ 1

60x120 ☞ 2  
 UNIKA ECRU MIX FLOOR  
**UKR3411A** rett. F 81,90

MIX WALL 60x80

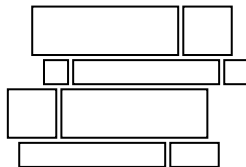

Nella confezione:  
 20x60 ☞ 4  
 20x20 ☞ 4  
 10x60 ☞ 4  
 10x20 ☞ 2  
 10x10 ☞ 4

60x80 ☞ 2  
 UNIKA ECRU MIX WALL  
**UKR20100** rett. F 74,90

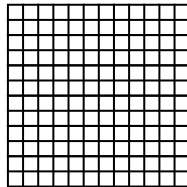

30x30 ☞ 4  
 MOS. OPUS MINI ECRU  
**UKR09102** rett. F 252,90

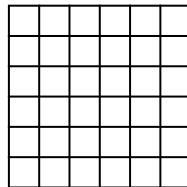

30x30 ☞ 6  
 MOS. QUADRETTI ECRU  
**UKR09101** rett. F 101,90



60x60 ☞ 2  
 DEC. LINK ECRU  
**UKR01105** rett. PZ 101,90

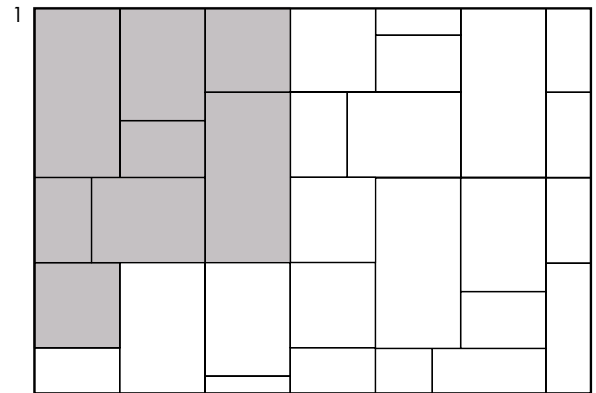

60x120 MIX FLOOR 80 %  
 60x60 20 %

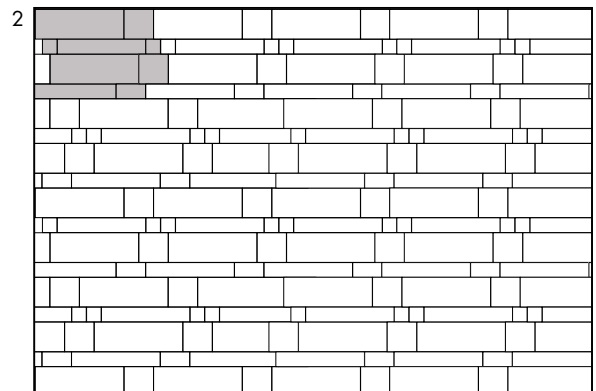

60x80 MIX WALL 100 %

**UNIKA**

BRONZE



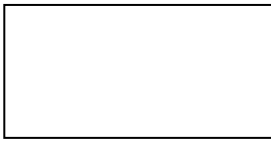

60x120 ☞ 2  
 UNIKA BRONZE  
**UKR3430A** rett. F 68,90  
**UKL3430A** ANTIQUE rett. F 81,90



30x120 ☞ 4  
 UNIKA BRONZE  
**UKR57300** rett. F 68,90

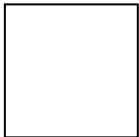

60x60 ☞ 3  
 UNIKA BRONZE  
**UKN01300** nat. F 46,90  
**UKR01300** rett. F 53,90  
**UKL01300** ANTIQUE rett. F 64,90

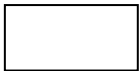

30x60 ☞ 6  
 UNIKA BRONZE  
**UKR03300** rett. F 49,90



10x30 ☞ 18  
 UNIKA BRONZE  
**UKR11300** rett. F 64,90

MIX FLOOR 60x120



Nella confezione:  
 60x120 ☞ 1  
 60x80 ☞ 1  
 60x40 ☞ 1



60x120 ☞ 2  
 UNIKA BRONZE MIX FLOOR  
**UKR3431A** rett. F 81,90

MIX WALL 60x80

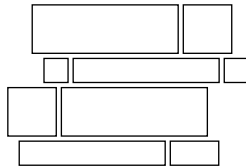

Nella confezione:  
 20x60 ☞ 4  
 20x20 ☞ 4  
 10x60 ☞ 4  
 10x20 ☞ 2  
 10x10 ☞ 4

60x80 ☞ 2  
 UNIKA BRONZE MIX WALL  
**UKR20300** rett. F 74,90

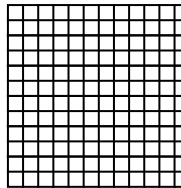

30x30 ☞ 4  
 MOS. OPUS MINI BRONZE  
**UKR09302** F 252,90

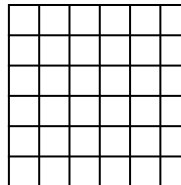

30x30 ☞ 6  
 MOS. QUADRETTI BRONZE  
**UKR09301** rett. F 101,90

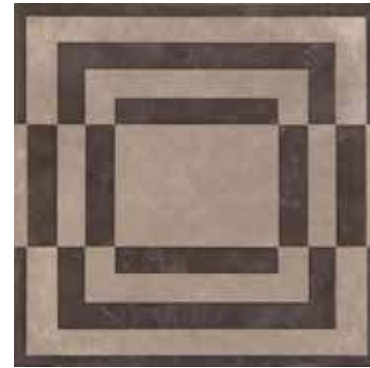

60x60 ☞ 2  
 DEC. LINK BRONZE  
**UKR01305** rett. PZ 101,90

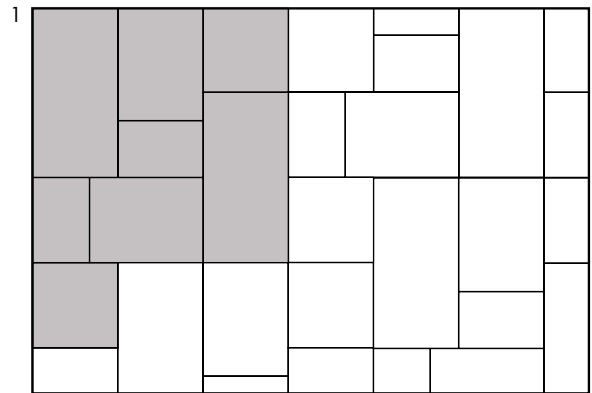

60x120 MIX FLOOR 80 %  
 60x60 20 %

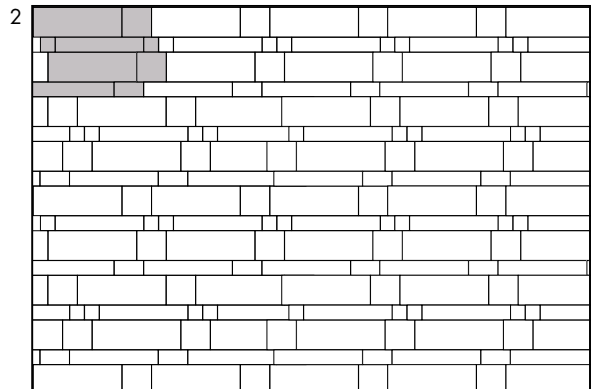

60x80 MIX WALL 100 %

**UNIKA**

GREY





60x120 ☞ 2  
 UNIKA GREY  
**UKR3415A** rett. F 68,90  
**UKL3415A** ANTIQUE rett. F 81,90



30x120 ☞ 4  
 UNIKA GREY  
**UKR57150** rett. F 68,90

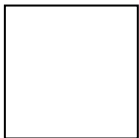

60x60 ☞ 3  
 UNIKA GREY  
**UKN01150** nat. F 46,90  
**UKR01150** rett. F 53,90  
**UKL01150** ANTIQUE rett. F 64,90

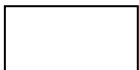

30x60 ☞ 6  
 UNIKA GREY  
**UKR03150** rett. F 49,90



10x30 ☞ 18  
 UNIKA GREY  
**UKR11150** rett. F 64,90

MIX FLOOR 60x120

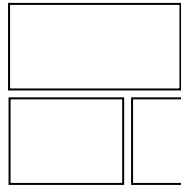

Nella confezione:  
 60x120 ☞ 1  
 60x80 ☞ 1  
 60x40 ☞ 1

60x120 ☞ 2  
 UNIKA GREY MIX FLOOR  
**UKR3416A** rett. F 81,90

MIX WALL 60x80

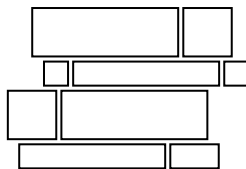

Nella confezione:  
 20x60 ☞ 4  
 20x20 ☞ 4  
 10x60 ☞ 4  
 10x20 ☞ 2  
 10x10 ☞ 4

60x80 ☞ 2  
 UNIKA GREY MIX WALL  
**UKR20150** rett. F 74,90

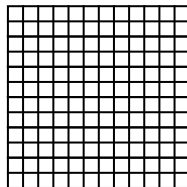

30x30 ☞ 4  
 MOS. OPUS MINI GREY  
**UKR09152** F 252,90

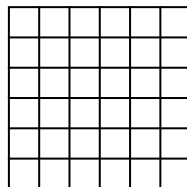

30x30 ☞ 6  
 MOS. QUADRETTI GREY  
**UKR09151** rett. F 101,90



60x60 ☞ 2  
 DEC. LINK GREY  
**UKR01155** rett. PZ 101,90

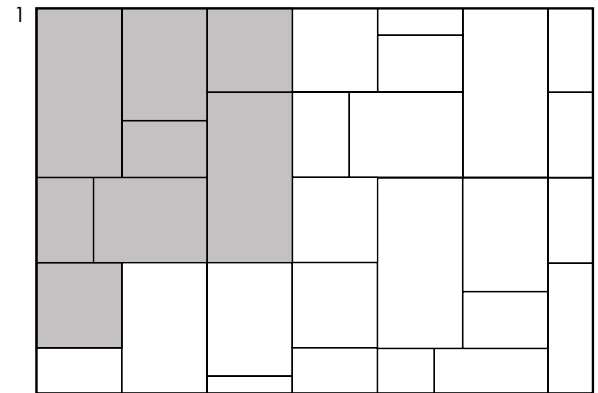

60x120 MIX FLOOR 80 %  
 60x60 20 %

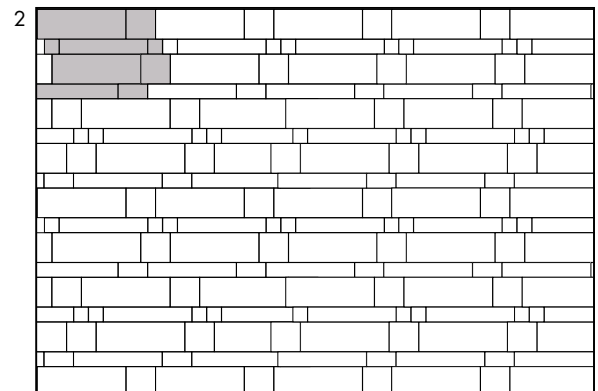

60x80 MIX WALL 100 %

**UNIKA**

SMOKE



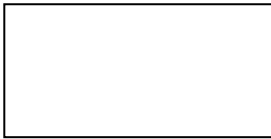

60x120 ☞ 2  
 UNIKA SMOKE  
**UKR3420A** rett. F 68,90  
**UKL3420A** ANTIQUE rett. F 81,90

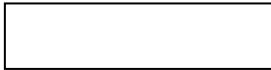

30x120 ☞ 4  
 UNIKA SMOKE  
**UKR57200** rett. F 68,90

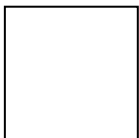

60x60 ☞ 3  
 UNIKA SMOKE  
**UKN01200** nat. F 46,90  
**UKR01200** rett. F 53,90  
**UKL01200** ANTIQUE rett. F 64,90



30x60 ☞ 6  
 UNIKA SMOKE  
**UKR03200** rett. F 49,90



10x30 ☞ 18  
 UNIKA SMOKE  
**UKR11200** rett. F 64,90

MIX FLOOR 60x120

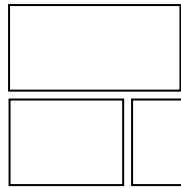

Nella confezione:  
 60x120 ☞ 1  
 60x80 ☞ 1  
 60x40 ☞ 1

60x120 ☞ 2  
 UNIKA SMOKE MIX FLOOR  
**UKR3421A** rett. F 81,90

MIX WALL 60x80

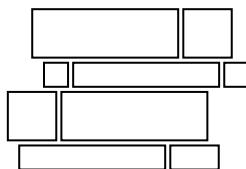

Nella confezione:  
 20x60 ☞ 4  
 20x20 ☞ 4  
 10x60 ☞ 4  
 10x20 ☞ 2  
 10x10 ☞ 4

60x80 ☞ 2  
 UNIKA SMOKE MIX WALL  
**UKR20200** rett. F 74,90

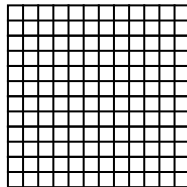

30x30 ☞ 4  
 MOS. OPUS MINI SMOKE  
**UKR09200** rett. F 252,90

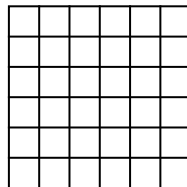

30x30 ☞ 6  
 MOS. QUADRETTI SMOKE  
**UKR09201** rett. F 101,90



60x60 ☞ 2  
 DEC. LINK SMOKE  
**UKR01205** rett. PZ 101,90

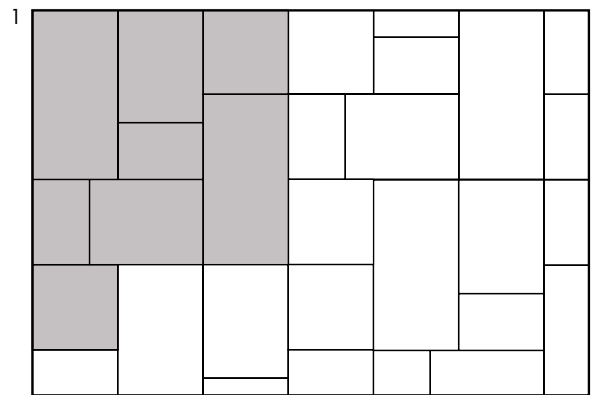

60x120 MIX FLOOR 80 %  
 60x60 20 %

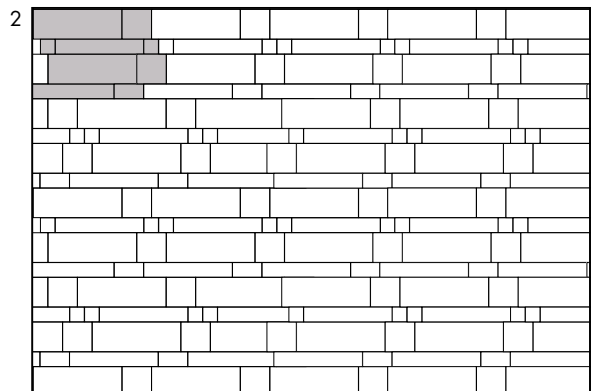

60x80 MIX WALL 100 %



# UNIKA



60x60  3  
UNIKA GAME ECRU  
**UKR01400** rett. F 64,90  
(UNIKA ECRU + DOLPHIN CLAY)



60x60  3  
UNIKA GAME GREY  
**UKR01450** rett. F 64,90  
(UNIKA GREY + DOLPHIN GREY)



60x60  3  
**UNIKA GAME SMOKE**  
**UKR01500** rett. F 64,90  
 (UNIKA SMOKE + DOLPHIN COAL)



60x60  3  
**UNIKA FREEDOM**  
**UKR01350** rett. F 64,90



10x60  3  
**LISTONE WOM**  
**UKR01161** rett. PZ 34,90



10x10  6  
**TOZZETTO WOM MIX 6**  
**UKR01162** rett. PZ 14,90



1,5x30  4  
**FASCIA VETRO PLATINO**  
**R1R03207** PZ 22,90



1,5x30  4  
**FASCIA VETRO BRONZO**  
**R1R03157** PZ 22,90



1,5x30  4  
**FASCIA VETRO ORO**  
**R1R03106** PZ 22,90

(Vetro e metalli preziosi - Glass and precious metals)



4x30  4  
**FASCIA ARDESIA BRONZO**  
**RER09054** PZ 20,90



4x30  4  
**FASCIA ARDESIA GRIGIO**  
**RER09204** PZ 20,90

(Pietra naturale - Natural stone)

# UNIKA OUTDOOR



ECRU

9 mm

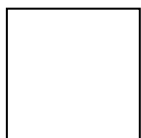

60x60 3  
UNIKA ECRU

**UKN01600** bocc. nat. F 46,90  
**UKR01600** bocc. rett. F 53,90

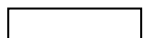

15x60 12  
UNIKA ECRU

**UKR04600** bocc. rett. F 57,90



20x40 15  
UNIKA ECRU

**UKN18100** bocc. nat. F 33,90



20x20 30  
UNIKA ECRU

**UKN22100** bocc. nat. F 33,90

20 mm



40x80 2  
UNIKA ECRU

**UKN51100** bocc. nat. F 91,90



GREY

9 mm



60x60 3  
UNIKA GREY

**UKN01650** bocc. nat. F 46,90  
**UKR01650** bocc. rett. F 53,90

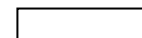

15x60 12  
UNIKA GREY

**UKR04650** bocc. rett. F 57,90



20x40 15  
UNIKA GREY

**UKN18150** bocc. nat. F 33,90



20x20 30  
UNIKA GREY

**UKN22150** bocc. nat. F 33,90

20 mm



40x80 2  
UNIKA GREY

**UKN51150** bocc. nat. F 91,90

# 20 MM

Lastra di 20 mm realizzata con la tecnologia del gres porcellanato, unisce la facilità di posa alle eccellenti prestazioni tecniche.

20 mm slab made using technical porcelain stoneware, combining ease of installation with excellent technical performance.

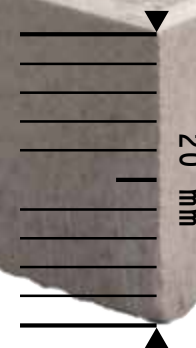

SMOKE

9 mm



60x60 3  
UNIKA SMOKE

**UKN01700** bocc. nat. F 46,90  
**UKR01700** bocc. rett. F 53,90

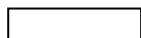

15x60 12  
UNIKA SMOKE

**UKR04700** bocc. rett. F 57,90



POSA TRADIZIONALE

La posa tradizionale è ideale per la realizzazione di pavimentazioni carrabili.

TRADITIONAL INSTALLATION

traditional installation is ideal for floorings that will be driven over by vehicles.



POSA SOPRAELEVATA

La posa sopraelevata consente il drenaggio delle acque piovane e la possibilità di ricavare uno spazio ispezionabile per il passaggio di impianti elettrici.

RAISED INSTALLATION

Raised installation enables rainwater to drain away and accessible space to be created for the inspection of electrical wiring.



A SECCO SU GHIAIA

La posa su ghiaia permette il perfetto drenaggio delle acque piovane.

DRY INSTALLATION ON GRAVEL

Installing on gravel enables perfect drainage of rainwater.



A SECCO SU ERBA

La posa diretta su erba permette di creare percorsi e camminamenti integrandosi perfettamente nell'ambiente.

DRY INSTALLATION ON GRASS

Installing directly on top of grass enables the creation of paths and walkways that blend in perfectly with the surroundings.



A SECCO SU SABBIA

La posa su sabbia permette di creare percorsi e camminamenti per spiagge e stabilimenti balneari.

DRY INSTALLATION ON SAND

Installing on top of sand is ideal for creating paths and walkways on beaches and beach bars.

20 mm



40x80 2  
UNIKA SMOKE

**UKN51200** bocc. nat. F 91,90

# WALL & PORCELAIN

UNA NUOVA CONCEZIONE DEL RIVESTIMENTO CERAMICO.

Abk ha pensato a una nuova idea di rivestimento in gres porcellanato, considerato come un elemento a se stante dal quale scegliere diverse tipologie stilistiche: dallo stile neutro alle campiture piene, dai mosaici lisci ai muretti tridimensionali, all'iperdecorativo con progettazioni di decorazioni a grande dimensione.

WALL & PORCELAIN coniuga le migliori caratteristiche del porcellanato quali resistenza, carico di rottura, grandi formati con le più funzionali caratteristiche dei prodotti da rivestimento come peso, facilità di posa e di lavorazione. È ideale come complemento da abbinare alle diverse tipologie estetiche di pavimenti in gres porcellanato tradizionale.



60x120 12  
UNIKA ILLUSION CREAM  
UKR34070 rett. F 81,90



60x120 12  
UNIKA ILLUSION GREY  
UKR34170 rett. F 81,90



60x120 12  
UNIKA ILLUSION SMOKE  
UKR34220 rett. F 81,90

NEW CERAMIC WALL COVERING CONCEPT.

Abk has conceived a new idea for porcelain wall coverings: an element in its own right, available in a wide range of styles: from the neutral style of solid colour backgrounds, from smooth mosaics and three-dimensional low walls to the ultra decorative style with large size decoration designs.

WALL & PORCELAIN combines the best features of porcelain stoneware, such as resistance, tensile strength and large formats with the most functional characteristics of wall coverings such as weight, easy installation and handling. It is ideal to be combined with the different aesthetic solutions of traditional porcelain stoneware floor tiles.

## CHARACTERISTIC

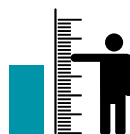

Piastrelle di grande formato, tutte con bordo RETTIFICATO.

Tiles with large size, all with RECTIFIED edges.



FACILITÀ di posa per maneggevolezza e MAGGIORE lavorabilità del prodotto per il posatore.

EASY to lay and handle and EASY-TO-WORK by the fitter.



MINORE peso e spessore per ridurre le problematiche di trasporto.

REDUCED weight and thickness to decrease transport problems.



ELIMINAZIONE dell'eventuale problema del cavillo tardivo post posa e GARANZIA di perfetta planarità.

ELIMINATION of the after-laying quibble and GUARANTEE of perfect planarity.



MAGGIORE aderenza del prodotto alla superficie per le caratteristiche di elasticità del prodotto e per il peso.

SUPERIOR adherence of the product to the surface thanks to the product elasticity and weight.

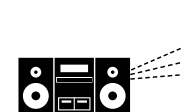

MAGGIORE isolamento termico ed acustico, le onde sonore sono assorbite e non rimbalzate.

IMPROVED thermal and acoustic insulation: sound waves are absorbed and do not bounce off.



Tutti i prodotti sono rettificati a secco per RIDURRE l'impatto ambientale.







All products are dry rectified in order to REDUCE the environmental impact.



Certificazione LEED per riduzione del consumo di materie prime naturali, riduzione del materiale da conferire in discarica, utilizzo di materiali derivanti da altre lavorazioni.





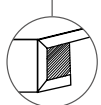

LEED certification for reduced consumption of natural raw materials, reduction of material to be dispatched to the landfill, use of recycled material resulting from other working processes.

## PEZZI SPECIALI / SPECIAL TRIMS

		CREAM	ECRU	BRONZE	GREY	SMOKE
	BATTISCOPA rett. 6,5x60 PZ 7,90  10	<b>UKR01051</b>	<b>UKR01101</b>	<b>UKR01301</b>	<b>UKR01151</b>	<b>UKR01201</b>
	ELEMENTO L MONOL. 15x30x3,5 PZ 14,90  8	-	<b>UKN018101</b>	-	<b>UKN018151</b>	-
	GRADONE TOP rett. 32x120x3x3 PZ 172,90  1	<b>UKR34051</b>	<b>UKR34101</b>	<b>UKR34301</b>	<b>UKR34151</b>	<b>UKR34201</b>



## IMBALLI / PACKAGING

FORMATO NOMINALE NOMINAL SIZE	FORMATO REALE REAL SIZE	 Thickness	 Pcs/Box	 Mq/Box	 Kg/Box	 Box/Pallet	 Mq/Pallet	 Kg/Pallet
60x120 / 24"x48" rett.	59,6x119,4	9	2	1,44	28,20	24	34,56	692
60x120 mix floor	-	9	2	1,44	27,20	25	36,00	720
30x120 / 12"x48" rett.	29,7x119,4	9	4	1,44	28,20	36	51,84	1002
60x80 mix wall	-	9	2	0,96	20,35	54	51,84	1119
60x60 / 24"x24" nat.	-	9	3	1,08	21,20	40	43,20	868
60x60 / 24"x24" rett.	59,6x59,6	9	3	1,08	21,20	40	43,20	868
30x60 / 12"x24" rett.	29,7x59,6	9	6	1,08	21,20	40	43,20	868
15x60 / 6"x24" rett.	14,75x59,6	9	12	1,08	21,20	40	43,20	868
10x30 / 4"x12" rett.	9,76x29,7	9	18	0,54	11,60	64	34,56	763
60x120 wall&porcelain rett.	59,6x119,4	9	2	1,44	26,20	24	34,56	650
40x80 nat. 20 mm	-	20	2	0,64	28,26	24	15,36	698
20x40 nat.	-	9	15	1,20	21,00	64	76,80	1364
20x20 nat.	-	9	30	1,20	21,00	64	76,80	1364

L'unità minima di vendita per tutti gli articoli (fondi, decori e pezzi speciali) è la scatola completa. / The minimum sales quantity for all items (plain tiles, decorations and special trims) is one full box. Pezzi speciali e decori per effetto delle lavorazioni, possono presentare variazioni di tonalità. / Due to working process special trims and decors, may show variation in tonality.

## SIGILLANTI COORDINATI PER FUGHE / COORDINATED GROUT SEALANTS

**HARDKOLL**

CODICE SIGILLANTE SEALANT CODE	ABBINAMENTO MATCHING
SI218B kromos manhattan 0-8	Ecrú - Grey
SI219B kromos grigio cemento 0-8	Bronze
SI217M kromos grigio luce 0-8	Cream
SI220B kromos antracite 0-8	Smoke

# RE-WORK

## GRES PORCELLANATO A MASSA COLORATA

FULL BODY COLOURED PORCELAIN STONEWARE

CLASSIFICAZIONE SECONDO NORME  
UNI EN 14411 (ISO 13006) ALLEGATO G-Gruppo B1a  
CLASSIFICATION IN ACCORDANCE  
WITH UNI EN 14411 (ISO 13006) ANNEX G-Group B1a

## SUPERFICI E FINITURE

SURFACES AND FINISHES

Naturale / Natural  
Naturale rettificato / Natural rectified  
Patinato rettificato / Honed rectified  
Lines rettificato / Lines rectified  
Naturale R11 / Natural R11

## FORMATI

SIZES

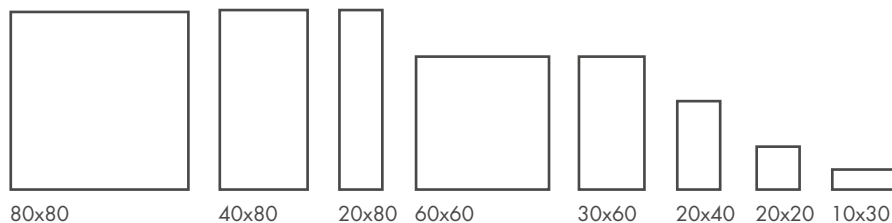

MULTI FOG



MULTI BEIGE



SINGLE 1  
BONE



SINGLE 1  
WARM



SINGLE 2  
WHITE



SINGLE 2  
GREY



SINGLE 3  
SILVER



SINGLE 3  
BLACK











# RE-WORK

MULTI FOG





40x80  3  
RE-WORK MULTI FOG  
**RER51400** rett. F 53,90

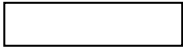

20x80  7  
RE-WORK MULTI FOG  
**RER49400** rett. F 58,90



20x80  7  
RE-WORK MULTI LINES FOG  
**RER49500** rett. F 58,90

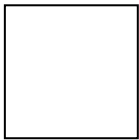

60x60  3  
RE-WORK MULTI FOG  
**RER01400** rett. F 53,90  
**RELO1400** patinato rett. F 64,90

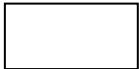

30x60  6  
RE-WORK MULTI FOG  
**REN03500** nat. F 38,90

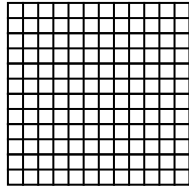

30x30  4  
MOS. OPUS MINI MULTI FOG  
**RER09403** rett. F 252,90



30x60  6  
MULTI FOG BRICK  
**REN03400** nat. F 40,90



30x60  2  
ANGOLARE MULTI FOG BRICK  
**REN03401** nat. PZ 32,90



80x80  1 cp  
COMP. SOUL FOG 4 pz.  
**RER49402** rett. PZ 199,90



4x30  4  
FASCIA ARDESIA GRIGIO  
**RER09204** rett. PZ 20,90  
(Pietra naturale - Natural stone)



1,5x30  4  
FASCIA VETRO PLATINO  
**R1R03207** PZ 22,90  
(Vetro e metalli preziosi - Glass and precious metals)



1,5x60  2  
MATITA METAL (alluminio - aluminium)  
**DWR01001** PZ 15,90



1,5x80  3  
MATITA METAL (alluminio - aluminium)  
**DKR51051** PZ 19,90



2x80  3  
LISTELLO FOGLIA ARGENTO  
**FSR51210** PZ 39,90

# RE-WORK

MULTI BEIGE





40x80  3  
RE-WORK MULTI BEIGE  
**RER51350** rett. F 53,90

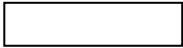

20x80  7  
RE-WORK MULTI BEIGE  
**RER49350** rett. F 58,90



20x80  7  
RE-WORK MULTI LINES BEIGE  
**RER49450** rett. F 58,90

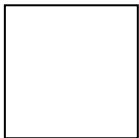

60x60  3  
RE-WORK MULTI BEIGE  
**RER01350** rett. F 53,90  
**RELO1350** patinato rett. F 64,90

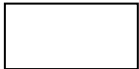

30x60  6  
RE-WORK MULTI BEIGE  
**REN03450** nat. F 38,90

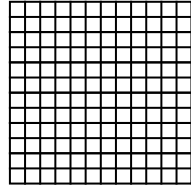

30x30  4  
MOS. OPUS MINI MULTI BEIGE  
**RER09353** rett. F 252,90



30x60  6  
MULTI BEIGE BRICK  
**REN03350** nat. F 40,90



30x60  2  
ANGOLARE MULTI BEIGE BRICK  
**REN03351** nat. PZ 32,90



80x80  1 cp  
COMP. SOUL BEIGE 4 pz.  
**RER49352** rett. PZ 199,90



4x30  4  
FASCIA ARDESIA BRONZO  
**RER09054** rett. PZ 20,90  
(Pietra naturale - Natural stone)



1,5x30  4  
FASCIA VETRO BRONZO  
**RIR03157** PZ 22,90  
(Vetro e metalli preziosi - Glass and precious metals)



1,5x60  2  
MATITA METAL (alluminio - aluminium)  
**DWR01001** PZ 15,90



1,5x80  3  
MATITA METAL (alluminio - aluminium)  
**DKR51051** PZ 19,90



2x80  3  
LISTELLO FOGLIA ORO  
**FSR51160** PZ 39,90



# RE-WORK

Single 2 White 30x60 - 60x60 rett. - Mosaico Opus Micro White - Fascia Ardesia Bronzo rett. 4x30





# RE-WORK

SINGLE 1 BONE



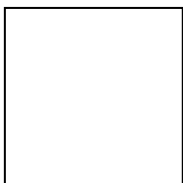

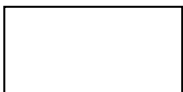

80x80  2  
RE-WORK SINGLE 1 BONE  
**RER52050** rett. F 68,90

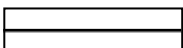

41,5x81  3  
RE-WORK SINGLE 1 BONE  
**REN50050** nat. F 46,90

40x80  3  
RE-WORK SINGLE 1 BONE  
**RER51050** rett. F 53,90



20x80  4  
RE-WORK LISTELLATO 3D SINGLE 1 BONE  
**REB49051** rett. F 199,90



60x60  3  
RE-WORK SINGLE 1 BONE  
**REN01050** nat. F 46,90  
**RER01050** rett. F 53,90  
**REL01050** patinato rett. F 64,90



30x60  6  
RE-WORK SINGLE 1 BONE  
**RER03050** rett. F 49,90



10x30  18  
RE-WORK SINGLE 1 BONE  
**RER11050** rett. F 64,90

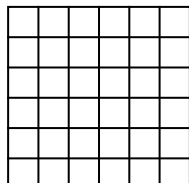

30x30  6  
MOS. QUAD. SINGLE 1 BONE  
**RER09051** rett. F 101,90



30x30  4  
MOS. OPUS MICRO SINGLE 1 BONE  
**RER09052** rett. PZ 39,90



4x30  4  
FASCIA ARDESIA BRONZO  
**RER09054** rett. PZ 20,90  
(Pietra naturale - Natural stone)



1,5x30  4  
FASCIA VETRO BRONZO  
**R1R03157** PZ 22,90  
(Vetro e metalli preziosi - Glass and precious metals)



1,5x60  4  
MATITA METAL (alluminio - aluminium)  
**DWR01001** PZ 15,90



1,5x80  3  
MATITA METAL (alluminio - aluminium)  
**DKR51051** PZ 19,90





2x80  3  
LISTELLO FOGLIA ORO  
**FSR51160** PZ 39,90

# RE-WORK

SINGLE 1 WARM

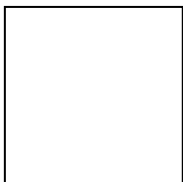



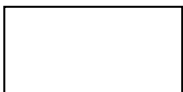

80x80  2  
RE-WORK SINGLE 1 WARM  
**RER52100** rett. F 68,90

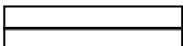

41,5x81  3  
RE-WORK SINGLE 1 WARM  
**REN50100** nat. F 46,90

40x80  3  
RE-WORK SINGLE 1 WARM  
**RER51100** rett. F 53,90



20x80  4  
RE-WORK LISTELLATO 3D SINGLE 1 WARM  
**RE49101** rett. F 199,90



60x60  3  
RE-WORK SINGLE 1 WARM  
**REN01100** nat. F 46,90  
**RER01100** rett. F 53,90  
**RELO1100** patinato rett. F 64,90



30x60  6  
RE-WORK SINGLE 1 WARM  
**RER03100** rett. F 49,90



10x30  18  
RE-WORK SINGLE 1 WARM  
**RER11100** rett. F 64,90

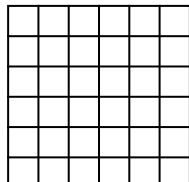

30x30  6  
MOS. QUAD. SINGLE 1 WARM  
**RER09101** rett. F 101,90



30x30  4  
MOS. OPUS MICRO SINGLE 1 WARM  
**RER09102** rett. PZ 39,90



4x30  4  
FASCIA ARDESIA BRONZO  
**RER09054** rett. PZ 20,90  
(Pietra naturale - Natural stone)



1,5x30  4  
FASCIA VETRO BRONZO  
**R1R03157** PZ 22,90  
(Vetro e metalli preziosi - Glass and precious metals)



1,5x60  4  
MATITA METAL (alluminio - aluminium)  
**DWR01001** PZ 15,90



1,5x80  3  
MATITA METAL (alluminio - aluminium)  
**DKR51051** PZ 19,90





2x80  3  
LISTELLO FOGLIA ORO  
**FSR51160** PZ 39,90

# RE-WORK

SINGLE 2 WHITE

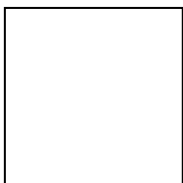



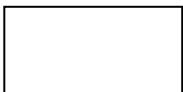

80x80  2  
RE-WORK SINGLE 2 WHITE  
**RER52150** rett. F 68,90

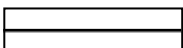

41,5x81  3  
RE-WORK SINGLE 2 WHITE  
**REN50150** nat. F 46,90

40x80  3  
RE-WORK SINGLE 2 WHITE  
**RER51150** rett. F 53,90



20x80  4  
RE-WORK LISTELLATO 3D SINGLE 2 WHITE  
**RER49151** rett. F 199,90



60x60  3  
RE-WORK SINGLE 2 WHITE  
**REN01150** nat. F 46,90  
**RER01150** rett. F 53,90  
**REL01150** patinato rett. F 64,90



30x60  6  
RE-WORK SINGLE 2 WHITE  
**RER03150** rett. F 49,90



10x30  18  
RE-WORK SINGLE 2 WHITE  
**RER11150** rett. F 64,90

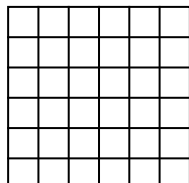

30x30  6  
MOS. QUAD. SINGLE 2 WHITE  
**RER09151** rett. F 101,90



30x30  4  
MOS. OPUS MICRO SINGLE 2 WHITE  
**RER09152** rett. PZ 39,90



4x30  4  
FASCIA ARDESIA BRONZO  
**RER09054** rett. PZ 20,90  
(Pietra naturale - Natural stone)



1,5x30  4  
FASCIA VETRO BRONZO  
**R1R03157** PZ 22,90  
(Vetro e metalli preziosi - Glass and precious metals)



1,5x60  4  
MATITA METAL (alluminio - aluminium)  
**DWR01001** PZ 15,90



1,5x80  3  
MATITA METAL (alluminio - aluminium)  
**DKR51051** PZ 19,90





2x80  3  
LISTELLO FOGLIA ARGENTO  
**FSR51210** PZ 39,90

# RE-WORK

SINGLE 2 GREY

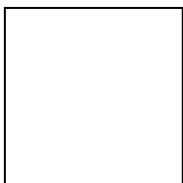



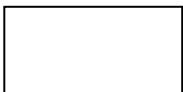

80x80  2  
RE-WORK SINGLE 2 GREY  
**RER52200** rett. F 68,90

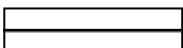

41,5x81  3  
RE-WORK SINGLE 2 GREY  
**REN50200** nat. F 46,90

40x80  3  
RE-WORK SINGLE 2 GREY  
**RER51200** rett. F 53,90



20x80  4  
RE-WORK LISTELLATO 3D SINGLE 2 GREY  
**RER49201** rett. F 199,90



60x60  3  
RE-WORK SINGLE 2 GREY  
**REN01200** nat. F 46,90  
**RER01200** rett. F 53,90  
**RELO1200** patinato rett. F 64,90



30x60  6  
RE-WORK SINGLE 2 GREY  
**RER03200** rett. F 49,90



10x30  18  
RE-WORK SINGLE 2 GREY  
**RER11200** rett. F 64,90

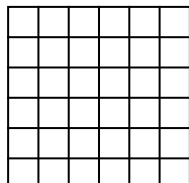

30x30  6  
MOS. QUAD. SINGLE 2 GREY  
**RER09201** rett. F 101,90

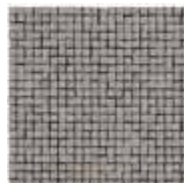

30x30  4  
MOS. OPUS MICRO SINGLE 2 GREY  
**RER09202** rett. PZ 39,90



4x30  4  
FASCIA ARDESIA GRIGIO  
**RER09204** rett. PZ 20,90  
(Pietra naturale - Natural stone)



1,5x30  4  
FASCIA VETRO PLATINO  
**R1R03207** PZ 22,90  
(Vetro e metalli preziosi - Glass and precious metals)



1,5x60  4  
MATITA METAL (alluminio - aluminium)  
**DWR01001** PZ 15,90



1,5x80  3  
MATITA METAL (alluminio - aluminium)  
**DKR51051** PZ 19,90



2x80  3  
LISTELLO FOGLIA ARGENTO  
**FSR51210** PZ 39,90



# RE-WORK

SINGLE 3 SILVER



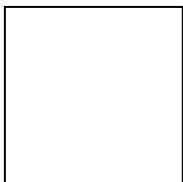

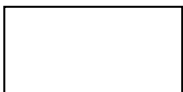

80x80  2  
RE-WORK SINGLE 3 SILVER  
**RER52250** rett. F 68,90

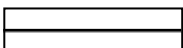

41,5x81  3  
RE-WORK SINGLE 3 SILVER  
**REN50250** nat. F 46,90

40x80  3  
RE-WORK SINGLE 3 SILVER  
**RER51250** rett. F 53,90



20x80  4  
RE-WORK LISTELLATO 3D SINGLE 3 SILVER  
**RER49251** rett. F 199,90



60x60  3  
RE-WORK SINGLE 3 SILVER  
**REN01250** nat. F 46,90  
**RER01250** rett. F 53,90  
**REL01250** patinato rett. F 64,90



30x60  6  
RE-WORK SINGLE 3 SILVER  
**RER03250** rett. F 49,90



10x30  18  
RE-WORK SINGLE 3 SILVER  
**RER11250** rett. F 64,90

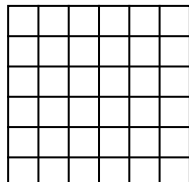

30x30  6  
MOS. QUAD. SINGLE 3 SILVER  
**RER09251** rett. F 101,90

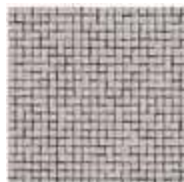

30x30  4  
MOS. OPUS MICRO SINGLE 3 SILVER  
**RER09252** rett. PZ 39,90



4x30  4  
FASCIA ARDESIA GRIGIO  
**RER09204** rett. PZ 20,90  
(Pietra naturale - Natural stone)



1,5x30  4  
FASCIA VETRO PLATINO  
**R1R03207** PZ 22,90  
(Vetro e metalli preziosi - Glass and precious metals)



1,5x60  4  
MATITA METAL (alluminio - aluminium)  
**DWR01001** PZ 15,90



1,5x80  3  
MATITA METAL (alluminio - aluminium)  
**DKR51051** PZ 19,90





2x80  3  
LISTELLO FOGLIA ARGENTO  
**FSR51210** PZ 39,90

# RE-WORK

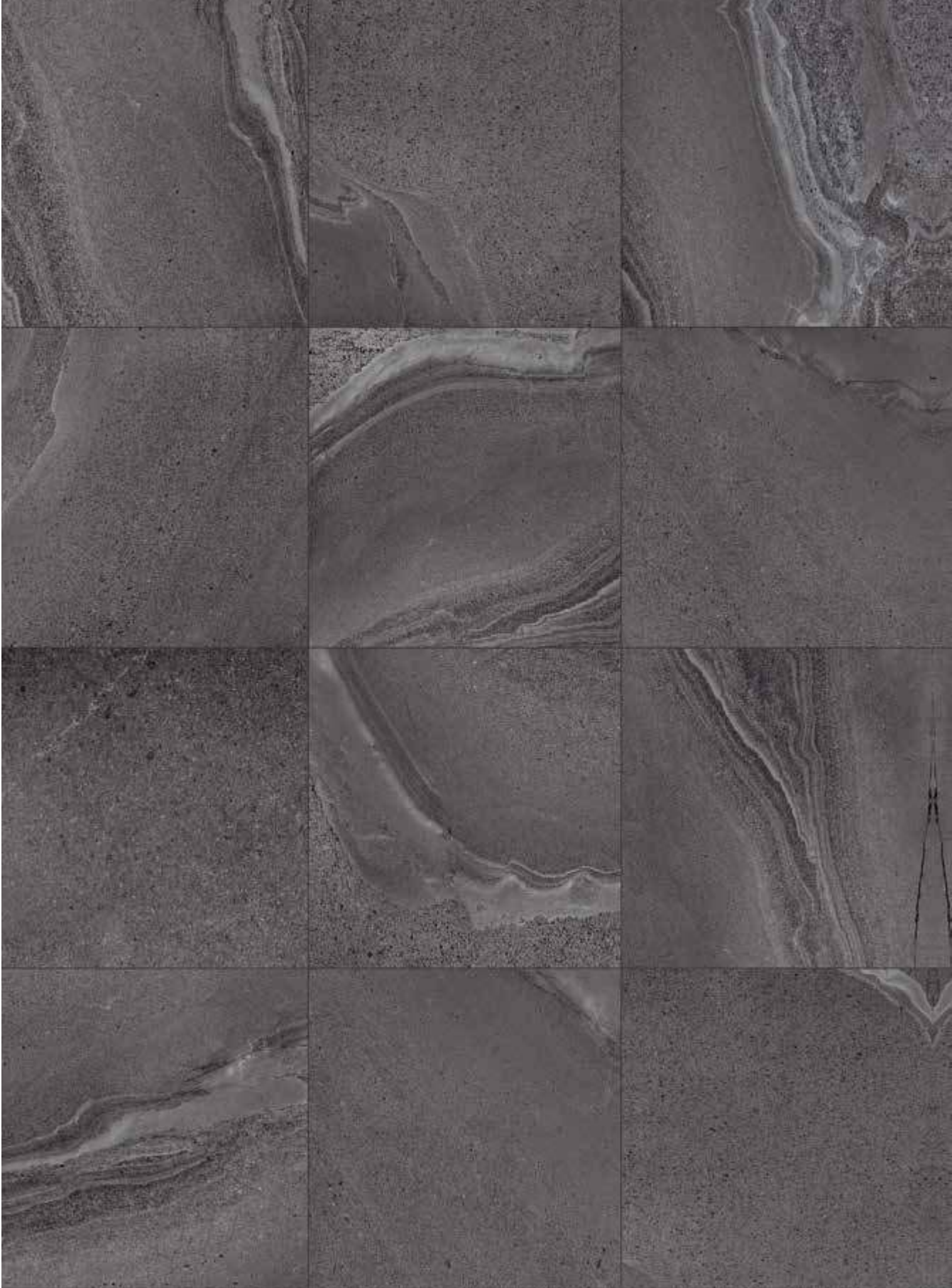
SINGLE 3 BLACK

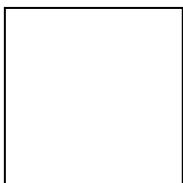



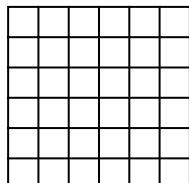

80x80  2  
RE-WORK SINGLE 3 BLACK  
**RER52300** rett. F 68,90



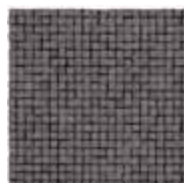

30x30  6  
MOS. QUAD. SINGLE 3 BLACK  
**RER09301** rett. F 101,90



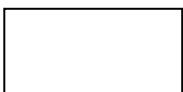

30x30  4  
MOS. OPUS MICRO SINGLE 3 BLACK  
**RER09302** rett. PZ 39,90

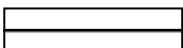

41,5x81  3  
RE-WORK SINGLE 3 BLACK  
**REN50300** nat. F 46,90

40x80  3  
RE-WORK SINGLE 3 BLACK  
**RER51300** rett. F 53,90



20x80  4  
RE-WORK LISTELLATO 3D SINGLE 3 BLACK  
**RER49301** rett. F 199,90



60x60  3  
RE-WORK SINGLE 3 BLACK  
**REN01300** nat. F 46,90  
**RER01300** rett. F 53,90  
**RELO1300** patinato rett. F 64,90



30x60  6  
RE-WORK SINGLE 3 BLACK  
**RER03300** rett. F 49,90



10x30  18  
RE-WORK SINGLE 3 BLACK  
**RER11300** rett. F 64,90



4x30  4  
FASCIA ARDESIA GRIGIO  
**RER09204** rett. PZ 20,90

(Pietra naturale - Natural stone)



1,5x30  4  
FASCIA VETRO PLATINO  
**R1R03207** PZ 22,90

(Vetro e metalli preziosi - Glass and precious metals)



1,5x60  4  
MATITA METAL (alluminio - aluminium)  
**DWR01001** PZ 15,90



1,5x80  3  
MATITA METAL (alluminio - aluminium)  
**DKR51051** PZ 19,90



2x80  3  
LISTELLO FOGLIA ARGENTO  
**FSR51210** PZ 39,90

# RE-WORK OUTDOOR



MULTI FOG

9 mm



20x40  15  
RE-WORK MULTI FOG

**REN18400** nat. F 33,90



20x20  30  
RE-WORK MULTI FOG

**REN22400** nat. F 33,90

20 mm



40x80  2  
RE-WORK MULTI FOG 20

**REN51400** nat. F 91,90



MULTI BEIGE

9 mm



20x40  15  
RE-WORK MULTI BEIGE

**REN18350** nat. F 33,90



20x20  30  
RE-WORK MULTI BEIGE

**REN22350** nat. F 33,90

20 mm

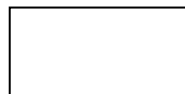

40x80  2  
RE-WORK MULTI BEIGE 20

**REN51350** nat. F 91,90

## 20 MM

Lastra di 20 mm realizzata con la tecnologia del gres porcellanato, unisce la facilità di posa alle eccellenti prestazioni tecniche.

20 mm slab made using technical porcelain stoneware, combining ease of installation with excellent technical performance.

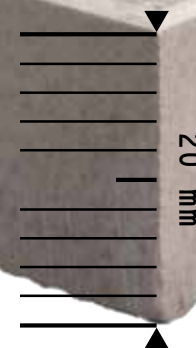

### POSA TRADIZIONALE

La posa tradizionale è ideale per la realizzazione di pavimentazioni carrabili.

### TRADITIONAL INSTALLATION

traditional installation is ideal for floorings that will be driven over by vehicles.



### POSA SOPRAELEVATA

La posa sopraelevata consente il drenaggio delle acque piovane e la possibilità di ricavare uno spazio ispezionabile per il passaggio di impianti elettrici.

### RAISED INSTALLATION

Raised installation enables rainwater to drain away and accessible space to be created for the inspection of electrical wiring.



### A SECCO SU GHIAIA

La posa su ghiaia permette il perfetto drenaggio delle acque piovane.

### DRY INSTALLATION ON GRAVEL

Installing on gravel enables perfect drainage of rainwater.



### A SECCO SU ERBA

La posa diretta su erba permette di creare percorsi e camminamenti integrandosi perfettamente nell'ambiente.

### DRY INSTALLATION ON GRASS

Installing directly on top of grass enables the creation of paths and walkways that blend in perfectly with the surroundings.



### A SECCO SU SABBIA

La posa su sabbia permette di creare percorsi e camminamenti per spiagge e stabilimenti balneari.









### DRY INSTALLATION ON SAND

Installing on top of sand is ideal for creating paths and walkways on beaches and beach bars.





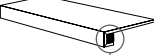

# RE-WORK

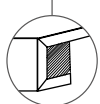
## PEZZI SPECIALI / SPECIAL TRIMS

		MULTI FOG	MULTI BEIGE	SINGLE 1 BONE	SINGLE 1 WARM	SINGLE 2 WHITE	SINGLE 2 GREY	SINGLE 3 SILVER	SINGLE 3 BLACK
	BATTISCOPIA rett. 6,5x80 PZ 8,90  8	-	-	RER52051	RER52101	RER52151	RER52201	RER52251	RER52301
	BATTISCOPIA rett. 6,5x60 PZ 7,90  10	RER01401	RER01351	RER01051	RER01101	RER01151	RER01201	RER01251	RER01301
	ELEMENTO L MONOL. 15x30x3,5 PZ 14,90  8	REN18401	REN18351	-	-	-	-	-	-
	GRADONE TOP rett. 33x60x3x3 PZ 79,90  2	RER03402	RER03352	RER03052	RER03102	RER03152	RER03202	RER03252	RER03302



## IMBALLI / PACKAGING

FORMATO NOMINALE NOMINAL SIZE	FORMATO REALE REAL SIZE	 Thickness	 Pcs/Box	 Mq/Box	 Kg/Box	 Box/Pallet	 Mq/Pallet	 Kg/Pallet
80x80 / 32"x32" rett.	80x80	11	2	1,28	32,50	40	51,20	1320
41,5x81 / 16.6"x32.4" nat.	-	9	3	1,01	19,50	30	30,30	605
40x80 / 16"x32" nat. 20 mm	-	20	2	0,64	28,26	24	15,36	698
40x80 / 16"x32" rett.	40x80	9	3	0,96	19,50	30	28,80	605
20x80 / 8"x32" rett.	19,9x80	9	7	1,12	21,00	42	47,04	1002
60x60 / 24"x24" nat./rett.	59,6x59,6	9	3	1,08	21,20	40	43,20	868
30x60 / 12"x24" rett.	29,7x59,6	9	6	1,08	21,20	40	43,20	868
30x60 / 12"x24" nat.	-	9	6	1,08	20,50	40	43,20	840
10x30 / 4"x12" rett.	9,76x29,7	9	18	0,54	11,60	64	34,56	763
20x40 / 8"x16" nat.	-	9	15	1,20	21,00	64	76,80	1364
20x20 / 8"x8" nat.	-	9	30	1,20	21,00	64	76,80	1364

L'unità minima di vendita per tutti gli articoli (fondi, decori e pezzi speciali) è la scatola completa. / The minimum sales quantity for all items (plain tiles, decorations and special trims) is one full box. Pezzi speciali e decori per effetto delle lavorazioni, possono presentare variazioni di tonalità. / Due to working process special trims and decors, may show variation in tonality.

## SIGILLANTI COORDINATI PER FUGHE / COORDINATED GROUT SEALANTS

**HARD KOLL**

CODICE SIGILLANTE SEALANT CODE	ABBINAMENTO MATCHING
SI218B kromos manhattan 0-8	Multi fog - Multi beige - Single 1 bone - Single 3 silver
SI219B kromos grigio cemento 0-8	Single 1 warm
SI217M kromos grigio luce 0-8	Single 2 white
SI220B kromos antracite 0-8	Single 2 grey - Single 3 black



# DOWNTOWN

## GRES PORCELLANATO A MASSA COLORATA

FULL BODY COLOURED PORCELAIN STONEWARE

CLASSIFICAZIONE SECONDO NORME  
UNI EN 14411 (ISO 13006) ALLEGATO G-Gruppo B1a  
CLASSIFICATION IN ACCORDANCE  
WITH UNI EN 14411 (ISO 13006) ANNEX G-Group B1a

## SUPERFICI E FINITURE

SURFACES AND FINISHES

Naturale / Natural  
Naturale rettificato / Natural rectified  
Lappato rettificato / Honed rectified  
Walk naturale / Walk natural

## FORMATI

SIZES

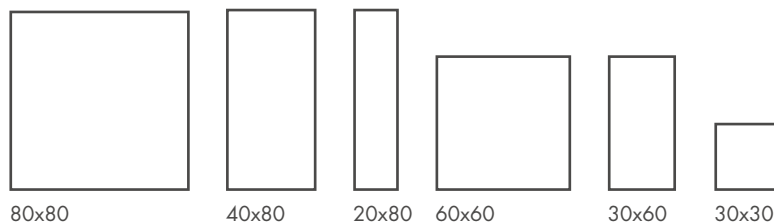



**INTERIORS**  
**NOUJI**  
2

# DOWNTOWN

Ivory rett. 30x60 - RANDOM Ivory rett. 60x60 - 30x60





# DOWNTOWN

IVORY



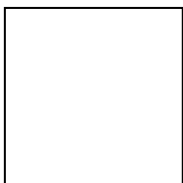

80x80 2  
DOWNTOWN IVORY  
**DWR52050** rett. F 68,90  
**DWL52050** lapp. rett. F 81,90

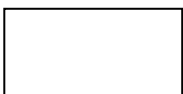

40x80 3  
DOWNTOWN IVORY  
**DWR51050** rett. F 53,90  
**DWL51050** lapp. rett. F 64,90

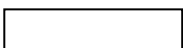

20x80 7  
DOWNTOWN IVORY  
**DWR4905A** rett. F 58,90

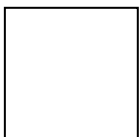

60x60 3  
DOWNTOWN IVORY  
**DWN01050** nat. F 46,90  
**DWR01050** rett. F 53,90  
**DWL01050** lapp rett. F 64,90



30x60 6  
DOWNTOWN IVORY  
**DWR03050** rett. F 49,90  
**DWL03050** lapp. rett. F 59,90

Nella confezione:

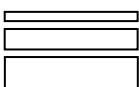

5x60 2  
10x60 2  
15x60 2

30x60 6  
DOWNTOWN IVORY  
**DWR00050** mix sizes rett. F 74,90



30x30 6  
DOWNTOWN IVORY  
**DWR09050** rett. F 53,90

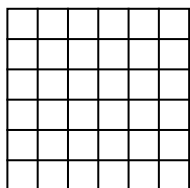

30x30 6  
MOSAICO QUADRETTI IVORY  
**DWR09051** rett. F 101,90  
**DWR03500** walk F 101,90



30x40 4  
MOSAICO BRICK IVORY/ASH  
**DWR51051** rett. PZ 21,90  
**DWL51051** lappato PZ 21,90

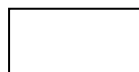

30x60 6  
DOWNTOWN IVORY  
**DWN03500** walk nat. F 38,90



# **DOWNTOWN**

ECRU





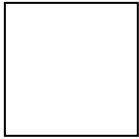

40x80  3  
 DOWNTOWN ECRU  
**DWR51000** rett. F 53,90  
**DWL51000** lapp. rett. F 64,90



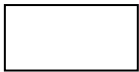

60x60  3  
 DOWNTOWN ECRU  
**DWN01100** nat. F 46,90  
**DWR01100** rett. F 53,90  
**DWL01100** lapp rett. F 64,90

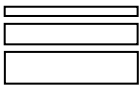

30x60  6  
 DOWNTOWN ECRU  
**DWR03100** rett. F 49,90  
**DWL03100** lapp. rett. F 59,90

Nella confezione:



5x60  2

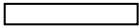

10x60  2

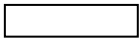



15x60  2

30x60  6  
 DOWNTOWN ECRU MIX SIZES  
**DWR00100** rett. F 74,90

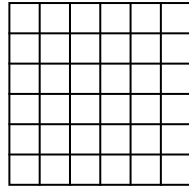

30x30  6  
 DOWNTOWN ECRU  
**DWR09100** rett. F 53,90



30x30  6  
 MOSAICO QUADRETTI ECRU  
**DWR09101** rett. F 101,90



30x40  4  
 MOSAICO BRICK ECRU/EARTH  
**DWR51001** rett. PZ 21,90  
**DWL51001** lappato PZ 21,90



# DOWNTOWN

EARTH





40x80 3  
 DOWNTOWN EARTH  
**DWR51150** rett. F 53,90  
**DWL51150** lapp. rett. F 64,90

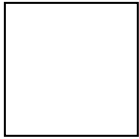

60x60 3  
 DOWNTOWN EARTH  
**DWN01150** nat. F 46,90  
**DWR01150** rett. F 53,90  
**DWL01150** lapp rett. F 64,90

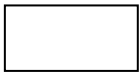

30x60 6  
 DOWNTOWN EARTH  
**DWR03150** rett. F 49,90  
**DWL03150** lapp. rett. F 59,90

Nella confezione:

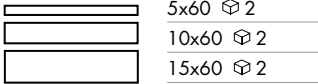

30x60 6  
 DOWNTOWN EARTH MIX SIZES  
**DWR00150** rett. F 74,90



30x30 6  
 DOWNTOWN EARTH  
**DWR09150** rett. F 53,90

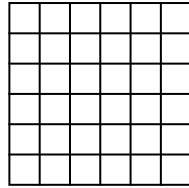

30x30 6  
 MOSAICO QUADRETTI EARTH  
**DWR09151** rett. F 101,90  
**DWR03550** walk F 101,90



30x40 4  
 MOSAICO BRICK ECRU/EARTH  
**DWR51001** rett. PZ 21,90  
**DWL51001** lappato PZ 21,90

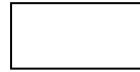

30x60 6  
 DOWNTOWN EARTH  
**DWN03550** walk nat. F 38,90

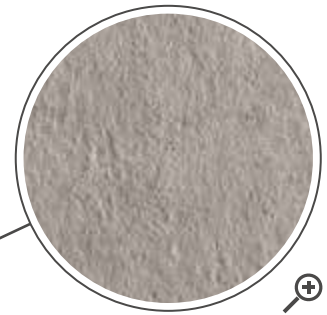

# **DOWNTOWN**

ASH



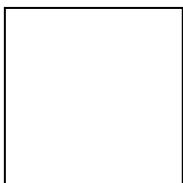

80x80 2  
DOWNTOWN ASH  
**DWR52200** rett. F 68,90  
**DWL52200** lapp. rett. F 81,90

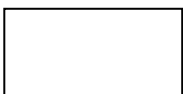

40x80 3  
DOWNTOWN ASH  
**DWR51200** rett. F 53,90  
**DWL51200** lapp. rett. F 64,90

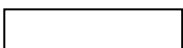

20x80 7  
DOWNTOWN ASH  
**DWR4920A** rett. F 58,90

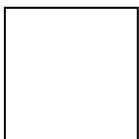

60x60 3  
DOWNTOWN ASH  
**DWN01200** nat. F 46,90  
**DWR01200** rett. F 53,90  
**DWL01200** lapp rett. F 64,90



30x60 6  
DOWNTOWN ASH  
**DWR03200** rett. F 49,90  
**DWL03200** lapp. rett. F 59,90

Nella confezione:



5x60 2



10x60 2

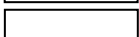

15x60 2

30x60 6  
DOWNTOWN ASH MIX SIZES  
**DWR00200** rett. F 74,90



30x30 6  
DOWNTOWN ASH  
**DWR09200** rett. F 53,90

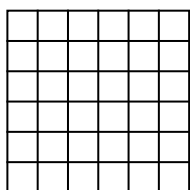

30x30 6  
MOSAICO QUADRETTI ASH  
**DWR09201** rett. F 101,90  
**DWR03600** walk F 101,90



30x40 4  
MOSAICO BRICK IVORY/ASH  
**DWR51051** rett. PZ 21,90  
**DWL51051** lappato PZ 21,90



30x60 2  
DEC. ONE WAY ARROW ASH  
**DWR03201** rett. PZ 44,90



30x60 2  
DEC. ONE WAY LINE ASH  
**DWR03202** rett. PZ 44,90

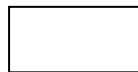

30x60 6  
DOWNTOWN ASH  
**DWN03600** walk nat. F 38,90

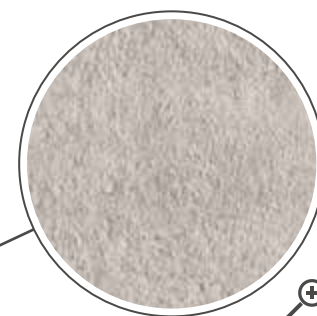

**DOWNTOWN**

GRAPHITE



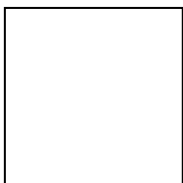

80x80  2  
 DOWNTOWN GRAPHITE  
**DWR52250** rett. F 68,90  
**DWL52250** lapp. rett. F 81,90

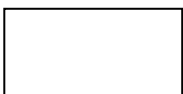

40x80  3  
 DOWNTOWN GRAPHITE  
**DWR51250** rett. F 53,90  
**DWL51250** lapp. rett. F 64,90

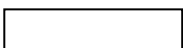

20x80  7  
 DOWNTOWN GRAPHITE  
**DWR4925A** rett. F 58,90

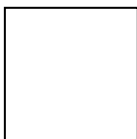



60x60  3  
 DOWNTOWN GRAPHITE  
**DWN01250** nat. F 46,90  
**DWR01250** rett. F 53,90  
**DWL01250** lapp rett. F 64,90

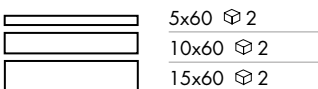

30x60  6  
 DOWNTOWN GRAPHITE  
**DWR03250** rett. F 49,90  
**DWL03250** lapp. rett. F 59,90

Nella confezione:



30x60  6  
 DOWNTOWN GRAPHITE MIX SIZES  
**DWR00250** rett. F 74,90



30x30  6  
 DOWNTOWN GRAPHITE  
**DWR09251** rett. F 53,90

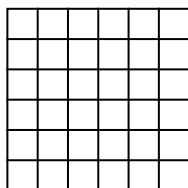

30x30  6  
 MOSAICO QUADRETTI GRAPHITE  
**DWR09251** rett. F 101,90





30x60  2  
 DEC. ONE WAY ARROW GRAPHITE  
**DWR03251** rett. PZ 44,90

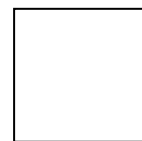
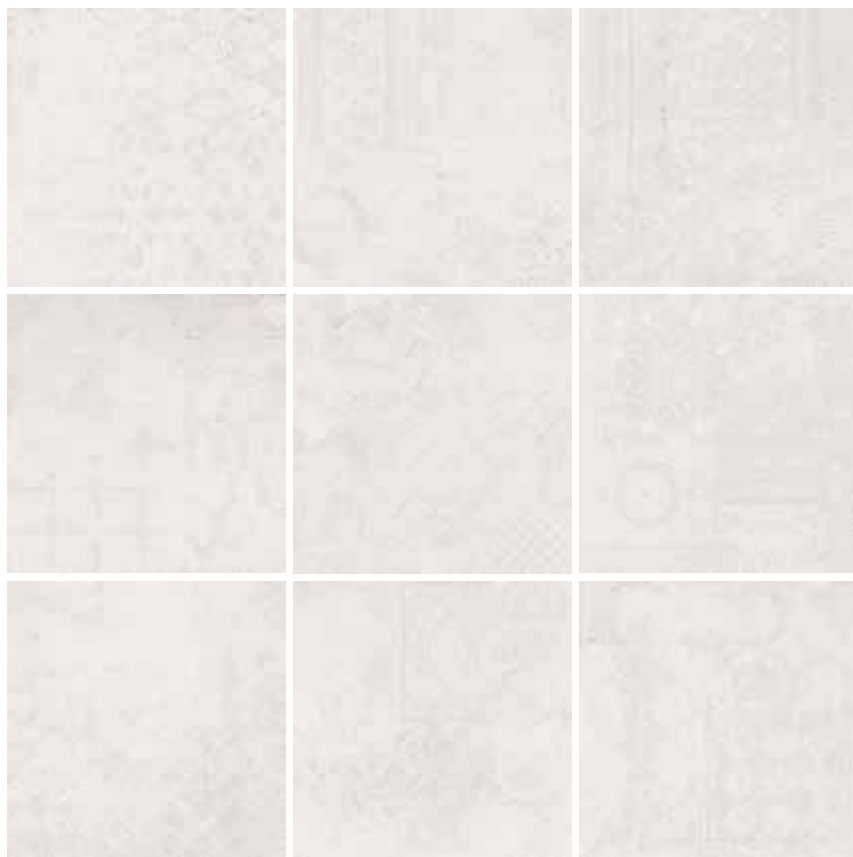

30x60  2  
 DEC. ONE WAY LINE GRAPHITE  
**DWR03252** rett. PZ 44,90

# DOWNTOWN



60x60  3  
DOWNTOWN IVORY RANDOM  
**DWR01060** rett. F 64,90



30x60  6  
DOWNTOWN IVORY RANDOM  
**DWR03060** rett. F 59,90



5x60  4  
LIST. DOWNTOWN IVORY RANDOM  
**DWR01061** rett. PZ 5,90

## FASCIA VETRO PLATINO

1,5x30  4  
\* FASCIA VETRO PLATINO  
**R1R03207** PZ 22,90

1,5x60  2

MATITA METAL (alluminio - aluminium)  
**DWR01001** PZ 15,90

1,5x80  3

MATITA METAL (alluminio - aluminium)  
**DKR51051** PZ 19,90

2x80  3

LISTELLO FOGLIA ARGENTO  
**FSR51210** PZ 39,90

\* Articoli realizzati in vetro e metalli preziosi; l'utilizzo a pavimento è indicato solo in ambito residenziale.  
Items produced with glass and precious metals: the floor use is suitable for residential area only.

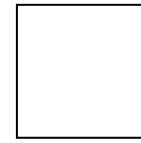

60x60  3  
 DOWNTOWN ECRU RANDOM  
**DWR01110** rett. F 64,90

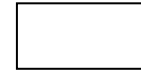

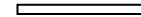

30x60  6  
 DOWNTOWN ECRU RANDOM  
**DWR03110** rett. F 59,90





5x60  4  
 LIST. DOWNTOWN ECRU RANDOM  
**DWR01111** rett. PZ 5,90

  
 1,5x30  4  
 \* FASCIA VETRO ORO  
**R1R03106** PZ 22,90

  
 1,5x30  4  
 \* FASCIA VETRO BRONZO  
**R1R03157** PZ 22,90

  
 1,5x60  2  
 MATITA METAL (alluminio - aluminium)  
**DWR01001** PZ 15,90

  
 1,5x80  3  
 MATITA METAL (alluminio - aluminium)  
**DKR51051** PZ 19,90

  
 2x80  3  
 LISTELLO FOGLIA ORO  
**FSR51160** PZ 39,90

\* Articoli realizzati in vetro e metalli preziosi; l'utilizzo a pavimento è indicato solo in ambito residenziale.  
 Items produced with glass and precious metals: the floor use is suitable for residential area only.







# DOWNTOWN

floor ECRU rett. 60x60 - ECRU RANDOM rett. 60x60





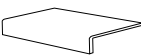

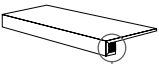

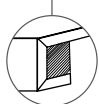
# DOWNTOWN

## PEZZI SPECIALI / SPECIAL TRIMS

		IVORY	ECRU	EARTH	ASH	GRAPHITE
 BATTISCOPA rett. 6,5x80 PZ 8,90  8		<b>DWR52051</b>	-	-	<b>DWR52201</b>	<b>DWR52251</b>
 BATTISCOPA rett. 6,5x60 PZ 7,90  10		<b>DWR01051</b>	<b>DWR01101</b>	<b>DWR01151</b>	<b>DWR01201</b>	<b>DWR01251</b>
 ELEMENTO L walk MONOL. 16,5x60x5 PZ 32,90  4		<b>DWN03501</b>	-	<b>DWN03551</b>	<b>DWN03601</b>	-
 GRADONE TOP rett. 33x60x3x3 PZ 79,90  2		<b>DWR01052</b>	<b>DWR01102</b>	<b>DWR01152</b>	<b>DWR01202</b>	<b>DWR01252</b>



## IMBALLI / PACKAGING

FORMATO NOMINALE NOMINAL SIZE	FORMATO REALE REAL SIZE	 Thickness	 Pcs/Box	 Mq/Box	 Kg/Box	 Box/Pallet	 Mq/Pallet	 Kg/Pallet
80x80 / 32"x32" rett.	80x80	11	2	1,28	32,50	40	51,20	1320
40x80 / 16"x32" rett.	40x80	9	3	0,96	19,50	30	28,80	605
20x80 / 8"x32" rett.	19,9x80	9	7	1,12	21,00	42	47,04	1002
60x60 / 24"x24" nat./rett.	59,6x59,6	9	3	1,08	21,20	40	43,20	868
30x60 / 12"x24" rett.	29,7x59,6	9	6	1,08	21,20	40	43,20	868
30x60 / 12"x24" nat.	-	9	6	1,08	20,50	40	43,20	840
30x30 / 12"x12" rett.	29,7x29,7	9	12	1,08	21,20	48	51,84	1038

L'unità minima di vendita per tutti gli articoli (fondi, decori e pezzi speciali) è la scatola completa. / The minimum sales quantity for all items (plain tiles, decorations and special trims) is one full box. Pezzi speciali e decori per effetto delle lavorazioni, possono presentare variazioni di tonalità. / Due to working process special trims and decors, may show variation in tonality.

## SIGILLANTI COORDINATI PER FUGHE / COORDINATED GROUT SEALANTS

**HARD KOLL**

CODICE SIGILLANTE SEALANT CODE	ABBINAMENTO MATCHING
SI217M kromos grigio luce 0-8	Downtown ivory
SI218B kromos manhattan 0-8	Downtown ecru
SI219B kromos grigio cemento 0-8	Downtown earth
SI218B kromos manhattan 0-8	Downtown ash
SI220B kromos antracite 0-8	Downtown graphite

# DOCKS

## GRES PORCELLANATO A MASSA COLORATA

FULL BODY COLOURED PORCELAIN STONEWARE

CLASSIFICAZIONE SECONDO NORME  
UNI EN 14411 (ISO 13006) ALLEGATO G-Gruppo B1a  
CLASSIFICATION IN ACCORDANCE  
WITH UNI EN 14411 (ISO 13006) ANNEX G-Group B1a

## SUPERFICI E FINITURE

SURFACES AND FINISHES

Naturale / Natural  
Naturale rettificato / Natural rectified  
Patinato rettificato / Honed rectified  
Walk naturale / Walk natural  
Form rettificato / Form rectified

## FORMATI

SIZES

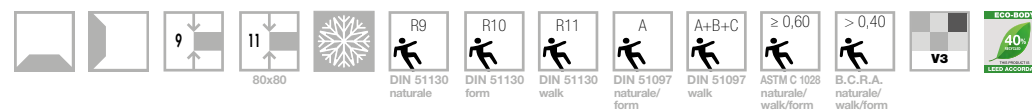
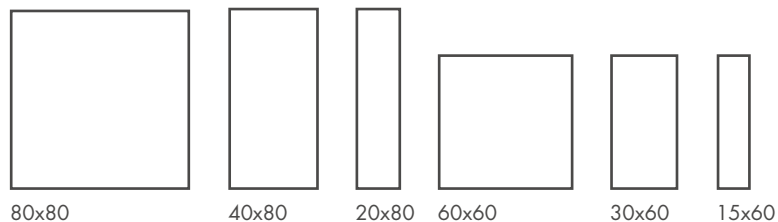



# DOCKS

Grey 20x80 pat. rett. - Black 40x80 rett.





# DOCKS

BLACK



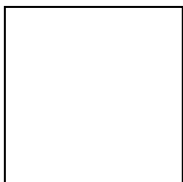

80x80 ☞ 2  
DOCKS BLACK

**DKR52200** rett. F 68,90  
**DKL52200** patinato rett. F 81,90

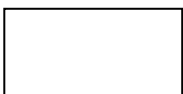

40x80 ☞ 3  
DOCKS BLACK

**DKR5120C** rett. F 53,90  
**DKL5120C** patinato rett. F 64,90

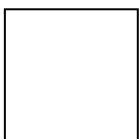

60x60 ☞ 3  
DOCKS BLACK

**DKN01200** nat. F 46,90  
**DKR01200** rett. F 53,90  
**DKL01200** patinato rett. F 64,90



30x60 ☞ 6  
DOCKS BLACK

**DKN03200** nat. F 38,90  
**DKR03200** rett. F 49,90  
**DKL03200** patinato rett. F 59,90

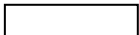

15x60 ☞ 12  
DOCKS BLACK

**DKR04200** rett. F 57,90

Nella confezione:



5x60 ☞ 2

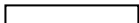

10x60 ☞ 2



15x60 ☞ 2

30x60 ☞ 6  
DOCKS BLACK MIX SIZES

**DKR00200** rett. F 74,90

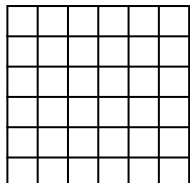

30x30 ☞ 6  
MOSAICO QUADRETTI BLACK

**DKR09201** F 101,90



30x40 ☞ 4  
MOSAICO BRICK GREY/BLACK

**DKR51152** PZ 21,90



# DOCKS

GREY



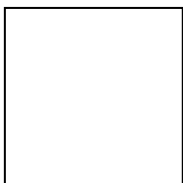

80x80 2  
DOCKS GREY  
**DKR52150** rett. F 68,90  
**DKL52150** patinato rett. F 81,90

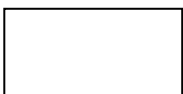

40x80 3  
DOCKS GREY  
**DKR5115C** rett. F 53,90  
**DKL5115C** patinato rett. F 64,90

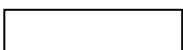

20x80 7  
DOCKS GREY  
**DKR4915A** rett. F 58,90  
**DKL4915A** patinato rett. F 67,90

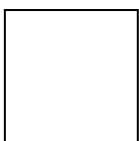

60x60 3  
DOCKS GREY  
**DKN01150** nat. F 46,90  
**DKR01150** rett. F 53,90  
**DKL01150** patinato rett. F 64,90

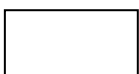

30x60 6  
DOCKS GREY  
**DKN03150** nat. F 38,90  
**DKR03150** rett. F 49,90  
**DKL03150** patinato rett. F 59,90

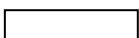

15x60 12  
DOCKS GREY  
**DKR04150** rett. F 57,90

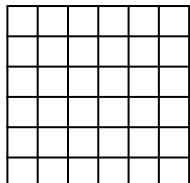

30x30 6  
MOSAICO QUADRETTI GREY  
**DKR09151** F 101,90

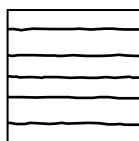

60x60 3  
DOCKS FORM GREY  
**DKR01600** rett. F 53,90

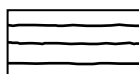

30x60 6  
DOCKS FORM GREY  
**DKR03600** rett. F 49,90

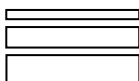

30x60 6  
DOCKS GREY MIX SIZES  
**DKR00150** rett. F 74,90

Nella confezione:

5x60 2

10x60 2

15x60 2



30x40 4  
MOSAICO BRICK GREY/BLACK  
**DKR51152** PZ 21,90

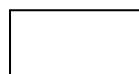

30x60 6  
DOCKS GREY  
**DKN03750** walk nat. F 38,90

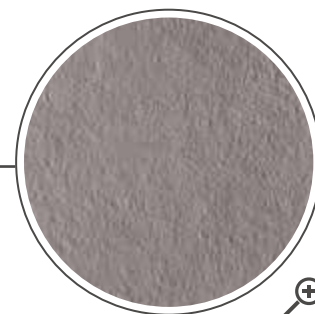

# DOCKS

SILVER



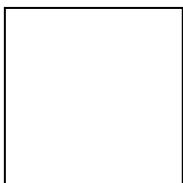

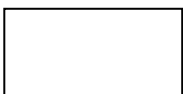

80x80  2  
DOCKS SILVER  
**DKR52100** rett. F 68,90  
**DKL52100** patinato rett. F 81,90

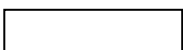

40x80  3  
DOCKS SILVER  
**DKR5110C** rett. F 53,90  
**DKL5110C** patinato rett. F 64,90



20x80  7  
DOCKS SILVER  
**DKR4910A** rett. F 58,90  
**DKL4910A** patinato rett. F 67,90

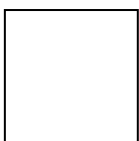

60x60  3  
DOCKS SILVER  
**DKN01100** nat. F 46,90  
**DKR01100** rett. F 53,90  
**DKL01100** patinato rett. F 64,90

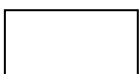

30x60  6  
DOCKS SILVER  
**DKN03100** nat. F 38,90  
**DKR03100** rett. F 49,90  
**DKL03100** patinato rett. F 59,90

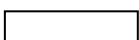

15x60  12  
DOCKS SILVER  
**DKR04100** rett. F 57,90

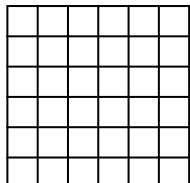

30x30  6  
MOSAICO QUADRETTI SILVER  
**DKR09101** F 101,90

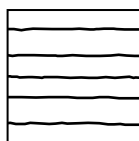

60x60  3  
DOCKS FORM SILVER  
**DKR01550** rett. F 53,90

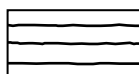

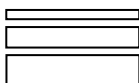

30x60  6  
DOCKS FORM SILVER  
**DKR03550** rett. F 49,90



30x60  6  
DOCKS SILVER MIX SIZES  
**DKR00100** rett. F 74,90

Nella confezione:

5x60  2

10x60  2

15x60  2



30x40  4  
MOSAICO BRICK WHITE/SILVER  
**DKR51052** PZ 21,90

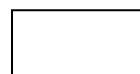

30x60  6  
DOCKS SILVER  
**DKN03700** walk nat. F 38,90

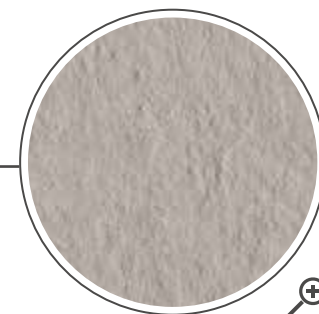

# DOCKS

WHITE

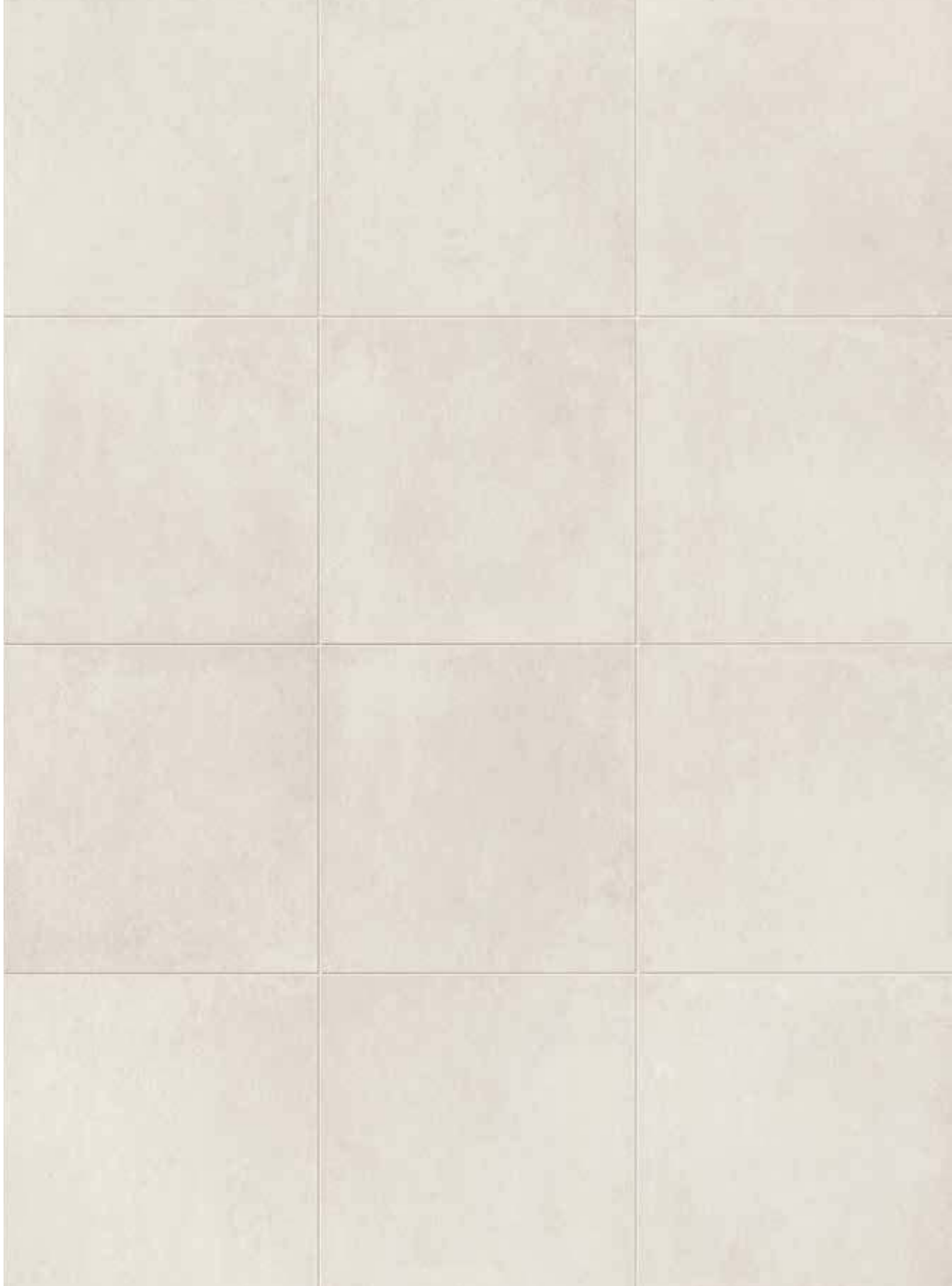



40x80 3  
DOCKS WHITE

**DKR5105C** rett. F 53,90  
**DKL5105C** patinato rett. F 64,90

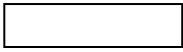

20x80 7  
DOCKS WHITE

**DKR4905A** rett. F 58,90  
**DKL4905A** patinato rett. F 67,90

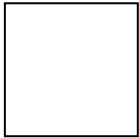

60x60 3  
DOCKS WHITE

**DKR01050** rett. F 53,90  
**DKL01050** patinato rett. F 64,90



30x60 6  
DOCKS WHITE

**DKR03050** rett. F 49,90  
**DKL03050** patinato rett. F 59,90



15x60 12  
DOCKS WHITE

**DKR04050** rett. F 57,90

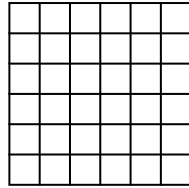

30x30 6  
MOSAICO QUADRETTI WHITE

**DKR09051** F 101,90

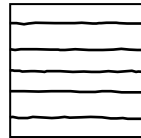

60x60 3  
DOCKS FORM WHITE

**DKR01500** rett. F 53,90

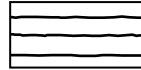

30x60 6  
DOCKS FORM WHITE

**DKR03500** rett. F 49,90

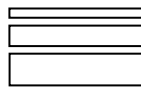

30x60 6  
DOCKS WHITE MIX SIZES

**DKR00050** rett. F 74,90

Nella confezione:

5x60 2

10x60 2

15x60 2



30x40 4  
MOSAICO BRICK WHITE/SILVER

**DKR51052** PZ 21,90

# DOCKS

BONE



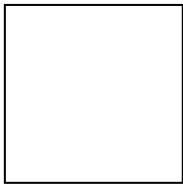

80x80  2  
DOCKS BONE  
**DKR52250** rett. F 68,90  
**DKL52250** patinato rett. F 81,90

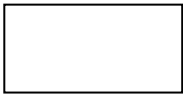

40x80  3  
DOCKS BONE  
**DKR5125C** rett. F 53,90  
**DKL5125C** patinato rett. F 64,90



20x80  7  
DOCKS BONE  
**DKR4925A** rett. F 58,90  
**DKL4925A** patinato rett. F 67,90

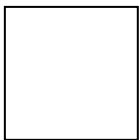

60x60  3  
DOCKS BONE  
**DKN01250** nat. F 46,90  
**DKR01250** rett. F 53,90  
**DKL01250** patinato rett. F 64,90

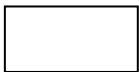

30x60  6  
DOCKS BONE  
**DKN03250** nat. F 38,90  
**DKR03250** rett. F 49,90  
**DKL03250** patinato rett. F 59,90

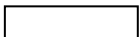

15x60  12  
DOCKS BONE  
**DKR04250** rett. F 57,90

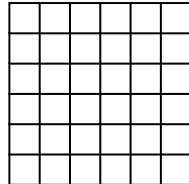

30x30  6  
MOSAICO QUADRETTI BONE  
**DKR09251** F 101,90

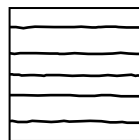



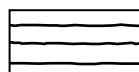

60x60  3  
DOCKS FORM BONE  
**DKR01650** rett. F 53,90

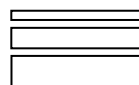

30x60  6  
DOCKS FORM BONE  
**DKR03650** rett. F 49,90



Nella confezione:  
5x60  2  
10x60  2  
15x60  2  
30x60  6  
DOCKS BONE MIX SIZES  
**DKR00250** rett. F 74,90



30x40  4  
MOSAICO BRICK BONE/WARM  
**DKR51252** PZ 21,90



# DOCKS

WARM





40x80 3  
DOCKS WARM

**DKR5130C** rett. F 53,90

**DKL5130C** patinato rett. F 64,90

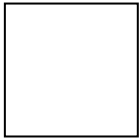

60x60 3  
DOCKS WARM

**DKR01300** rett. F 53,90

**DKL01300** patinato rett. F 64,90



30x60 6  
DOCKS WARM

**DKR03300** rett. F 49,90

**DKL03300** patinato rett. F 59,90

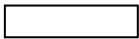

15x60 12  
DOCKS WARM

**DKR04300** rett. F 57,90

Nella confezione:

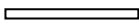

5x60 2



10x60 2



15x60 2

30x60 6  
DOCKS WARM MIX SIZES

**DKR00300** rett. F 74,90

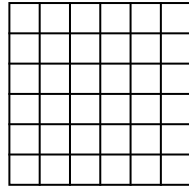

30x30 6  
MOSAICO QUADRETTI WARM

**DKR09301** F 101,90



30x40 4  
MOSAICO BRICK BONE/WARM

**DKR51252** PZ 21,90

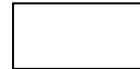

30x60 6  
DOCKS WARM

**DKN03800** walk nat. F 38,90

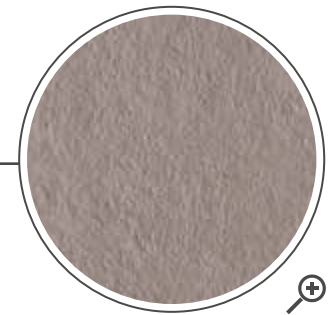

# DOCKS



30x240  1 cp./box  
COMP. OPERA RED 4 PZ SX  
**DKR03260** rett. PZ 159,90  
(prezzo a cp.)

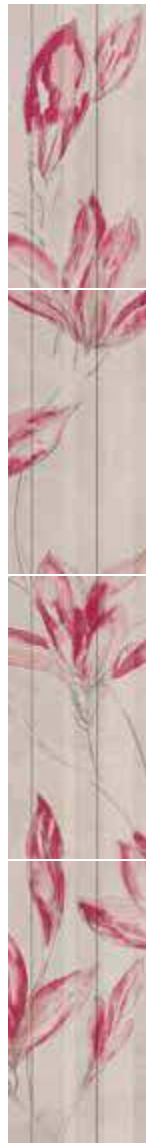

30x240  1 cp./box  
COMP. OPERA RED 4 PZ DX  
**DKR03261** rett. PZ 159,90  
(prezzo a cp.)



10x60  4  
LIST. OPERA RED  
**DKR03262** rett. PZ 26,90



30x240  1 cp./box  
COMP. OPERA BLUE 4 PZ SX  
**DKR03060** rett. PZ 159,90  
(prezzo a cp.)



30x240  1 cp./box  
COMP. OPERA BLUE 4 PZ DX  
**DKR03061** rett. PZ 159,90  
(prezzo a cp.)



10x60  4  
LIST. OPERA BLUE  
**DKR03062** rett. PZ 26,90



30x60  4  
DEC. MURALES BONE MIX 4  
**DKR03263** rett. PZ 43,90



30x60  4  
DEC. MURALES WHITE MIX 4  
**DKR03063** rett. PZ 43,90





30x60  4  
DEC. MURALES SILVER MIX 4  
**DKR03113** rett. PZ 43,90



2x60  4  
MAT. MURALES BRONZE  
**DKR03064** rett. PZ 13,90



15x60  2  
DEC. SPLASH BLUE MIX 2  
**DKL04051** rett. PZ 39,90

2x60  4  
MATITA SPLASH BLUE  
**DKL04052** rett. PZ 13,90



15x60  2  
DEC. SPLASH ARANCIO MIX 2  
**DKL04251** rett. PZ 39,90

2x60  4  
MATITA SPLASH ARANCIO  
**DKL04252** rett. PZ 13,90

1,5x30  4  
\* FASCIA VETRO PLATINO  
**R1R03207** PZ 22,90

1,5x30  4  
\* FASCIA VETRO BRONZO  
**R1R03157** PZ 22,90

1,5x80  3  
MATITA METAL (alluminio - aluminium)  
**DKR51051** PZ 19,90

\* Articoli realizzati in vetro e metalli preziosi; l'utilizzo a pavimento è indicato solo in ambito residenziale.  
Items produced with glass and precious metals: the floor use is suitable for residential area only.

# DOCKS

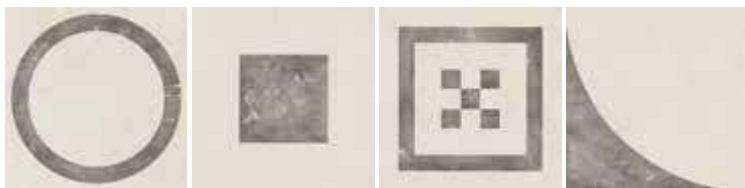

30x30  4  
 DECORO COMBI 4 BIANCO/NERO  
**DKR01062** rett. F 26,90



30x30  4  
 DECORO COMBI 4 BEIGE/ROSSO  
**DKR01262** rett. F 26,90



30x30  4  
 DECORO COMBI 4 GRIGIO/NERO  
**DKR01112** rett. F 26,90



30x30  4  
 DECORO COMBI 4 GRIGIO/ROSSO  
**DKR01113** rett. F 26,90



20x80  3  
 DEC. VINTAGE LIGHT MIX 3  
**DKR49053** rett. PZ 48,90



20x80  3  
 DEC. VINTAGE DARK MIX 3  
**DKR49054** rett. PZ 48,90

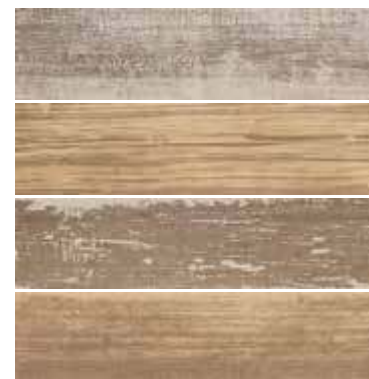







15x60  4  
 DEC. VINTAGE MIX 4  
**DKR04051** rett. PZ 26,90

# DOCKS

## PEZZI SPECIALI / SPECIAL TRIMS

	BLACK	GREY	SILVER	WHITE	BONE	WARM
 BATTISCOPIA nat. 7,5x60 PZ 7,90  10	<b>DKN01201</b>	<b>DKN01151</b>	<b>DKN01101</b>	-	<b>DKN01251</b>	-
 BATTISCOPIA rett. 7,5x60 PZ 7,90  10	<b>DKR01201</b>	<b>DKR01151</b>	<b>DKR01101</b>	<b>DKR01051</b>	<b>DKR01251</b>	<b>DKR01301</b>
 BATTISCOPIA rett. 5x80 PZ 8,90  8	<b>DKR52201</b>	<b>DKR52151</b>	<b>DKR52101</b>	-	<b>DKR52251</b>	-
 GRADONE TOP rett. 33x60x3x3 PZ 79,90  2	<b>DKR03205</b>	<b>DKR03155</b>	<b>DKR03105</b>	<b>DKR03055</b>	<b>DKR03255</b>	<b>DKR03305</b>
 ELEM. L WALK 16,5x60x5 PZ 32,90  4	-	<b>DKN03751 GREY WALK</b>	<b>DKN03701 SILVER WALK</b>	-	-	<b>DKN03801 WARM WALK</b>

## IMBALLI / PACKAGING

FORMATO NOMINALE NOMINAL SIZE	FORMATO REALE REAL SIZE	 Thickness	 Pcs/Box	 Mq/Box	 Kg/Box	 Box/Pallet	 Mq/Pallet	 Kg/Pallet
80x80 / 32"x32" rett.	80x80	11	2	1,28	32,50	40	51,20	1320
40x80 / 16"x32" rett.	40x80	9	3	0,96	19,50	30	28,80	605
20x80 / 8"x32" rett.	19,9x80	9	7	1,12	21,00	42	47,04	1002
60x60 / 24"x24" nat./rett.	59,6x59,6	9	3	1,08	21,20	40	43,20	868
30x60 / 12"x24" rett.	29,7x59,6	9	6	1,08	21,20	40	43,20	868
30x60 / 12"x24" mix sizes rett.	29,7x59,6	9	6	1,08	21,20	40	43,20	868
30x60 / 12"x24" nat.	-	9	6	1,08	20,50	40	43,20	840
15x60 / 6"x24" rett.	14,75x59,6	9	12	1,08	21,20	40	43,20	868

L'unità minima di vendita per tutti gli articoli (fondi, decori e pezzi speciali) è la scatola completa. / The minimum sales quantity for all items (plain tiles, decorations and special trims) is one full box. Pezzi speciali e decori per effetto delle lavorazioni, possono presentare variazioni di tonalità. / Due to working process special trims and decors, may show variation in tonality.

## SIGILLANTI COORDINATI PER FUGHE / COORDINATED GROUT SEALANTS

**HARD KOLL**

CODICE SIGILLANTE SEALANT CODE	ABBINAMENTO MATCHING
SI219B kromos grigio cemento 0-8	Docks silver
SI220B kromos antracite 0-8	Docks grey - Docks black
SI217M kromos grigio luce 0-8	Docks white - Docks bone
SI218B kromos manhattan 0-8	Docks warm

# PAPIER

## GRES PORCELLANATO A MASSA COLORATA

FULL BODY COLOURED PORCELAIN STONEWARE

CLASSIFICAZIONE SECONDO NORME  
UNI EN 14411 (ISO 13006) ALLEGATO G-Gruppo B1a  
CLASSIFICATION IN ACCORDANCE  
WITH UNI EN 14411 (ISO 13006) ANNEX G-Group B1a

## SUPERFICI E FINITURE

SURFACES AND FINISHES

Naturale rettificato / Natural rectified

## FORMATI

SIZES



60x60

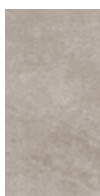

GRIGIO



ANTRACITE



CORDA

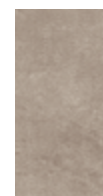

NOCCIOLA



DIN 51130  
naturale



DIN 51097  
naturale



ASTM C 1028  
naturale



B.C.R.A.  
naturale











# PAPIER

GRIGIO

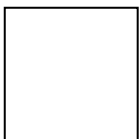

60x60  3  
PAPIER GRIGIO

**PPR01250** rett.

F 53,90

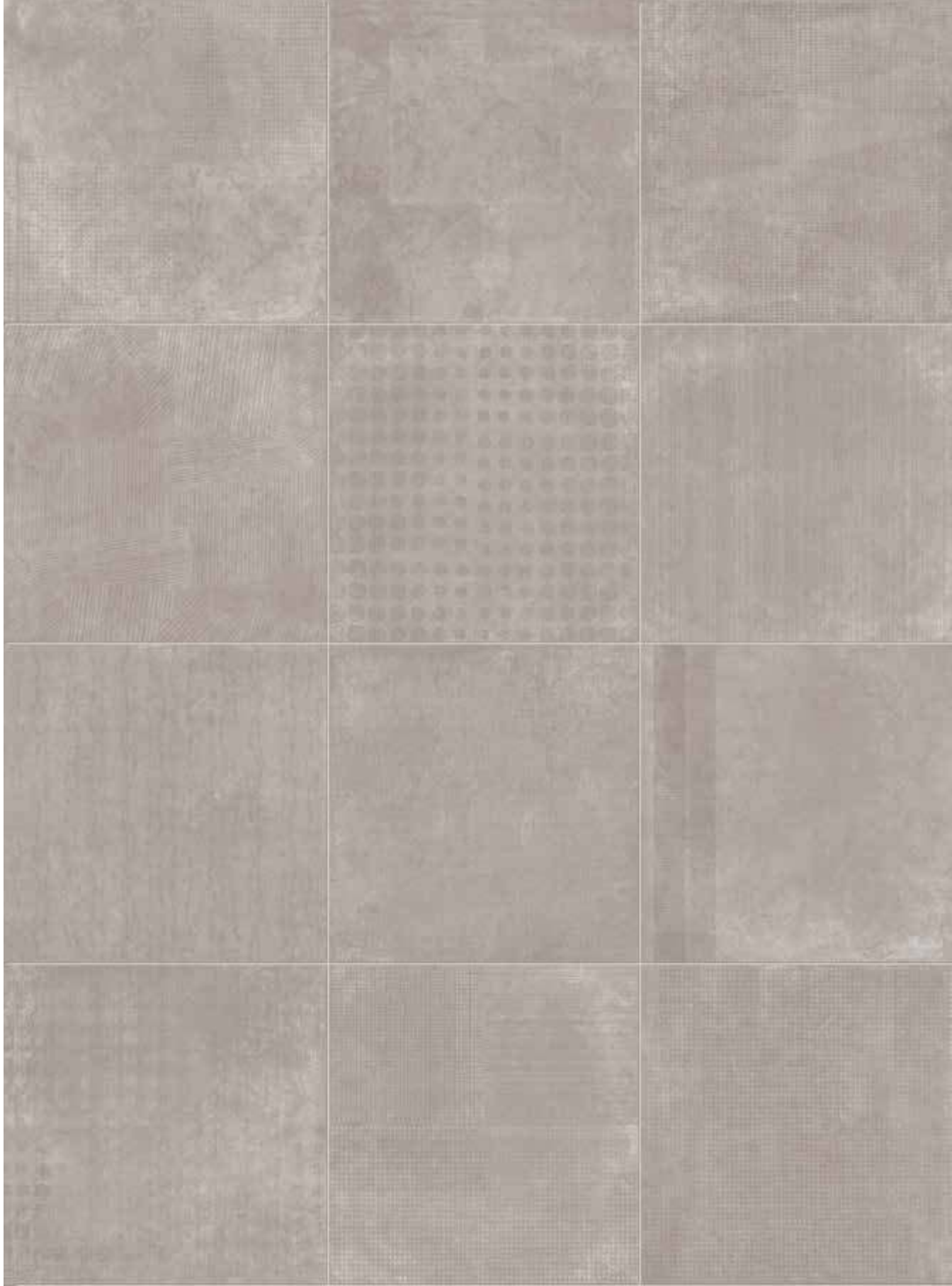

# PAPIER

ANTRACITE

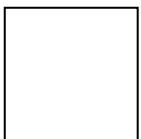

60x60  3  
PAPIER ANTRACITE

**PPR01300** rett.

F 53,90



# PAPIER

CORDA

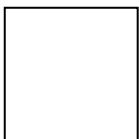

60x60  3  
PAPIER CORDA

**PPR01100** rett.

F 53,90

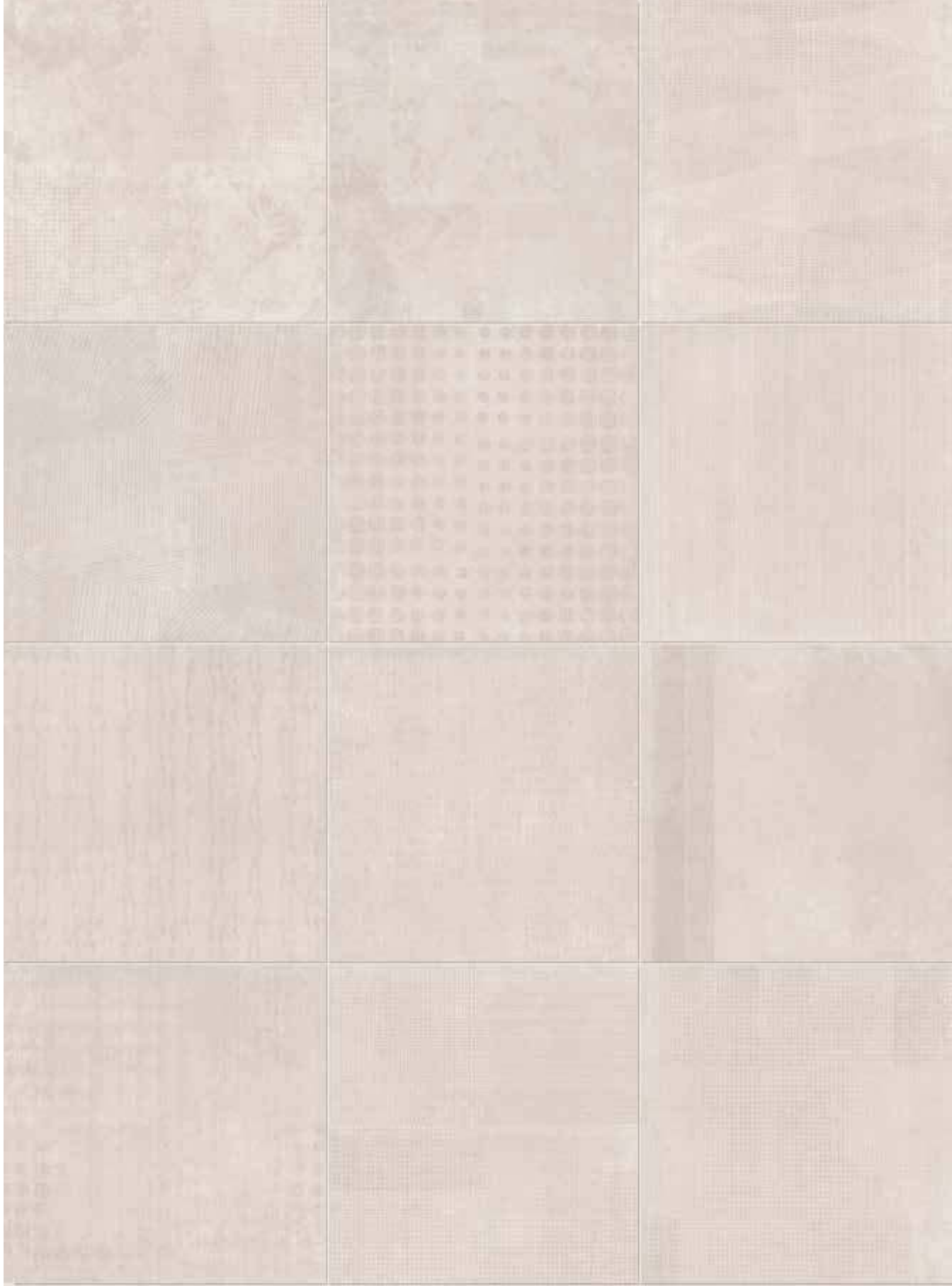

# PAPIER

NOCCIOLA

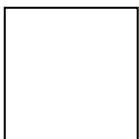

60x60  3  
PAPIER NOCCIOLA

**PPR01150** rett.



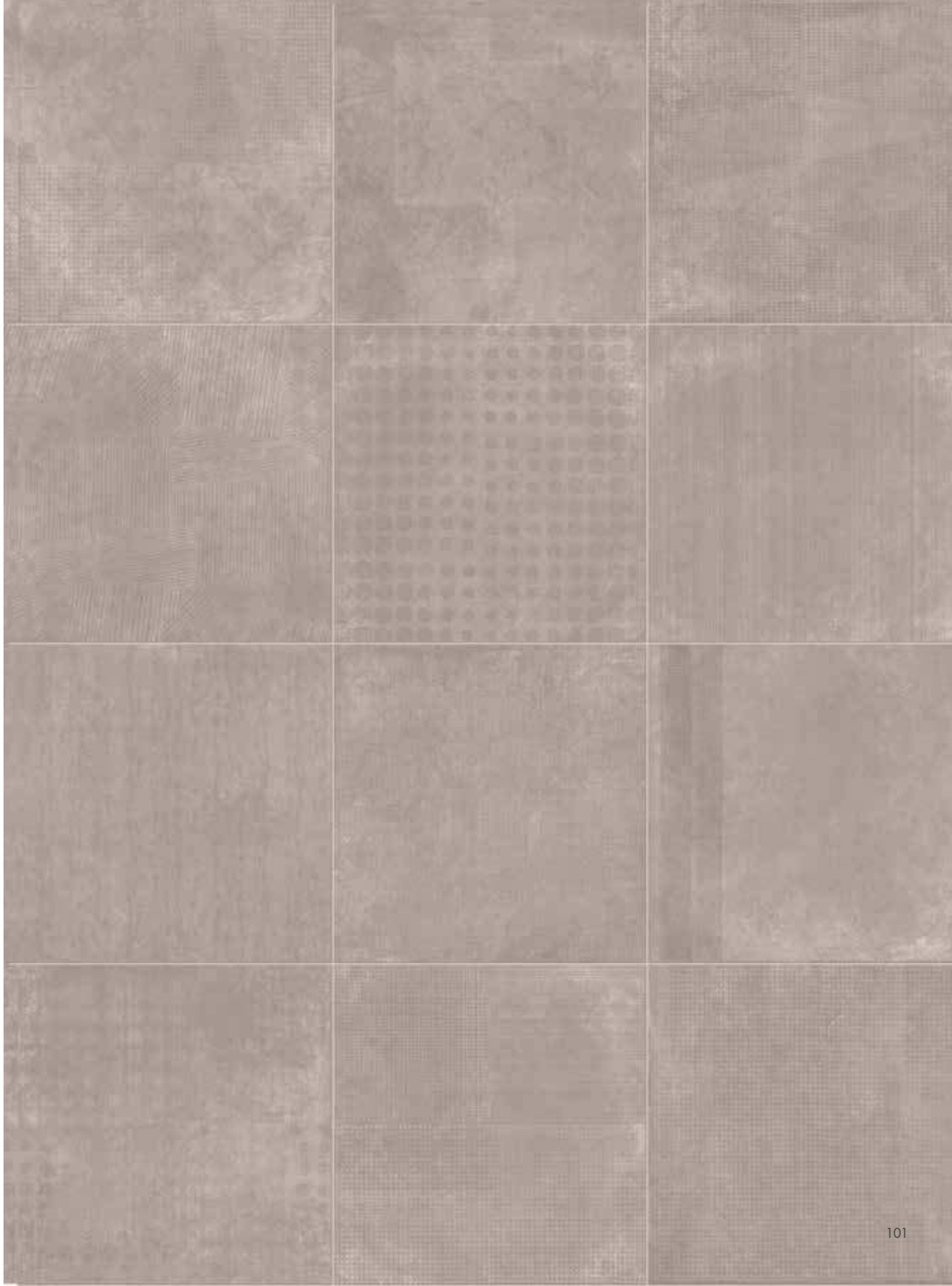



F 53,90



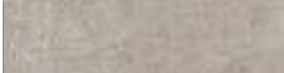







# PAPIER

## PEZZI SPECIALI / SPECIAL TRIMS

					
		PAPER GRIGIO	PAPER ANTRACITE	PAPER CORDA	PAPER NOCCIOLA
	BATTISCOPA rett. 6,5x60 PZ 7,90  10	<b>PPR01251</b>	<b>PPR01301</b>	<b>PPR01101</b>	<b>PPR01151</b>

## IMBALLI / PACKAGING

FORMATO NOMINALE NOMINAL SIZE	FORMATO REALE REAL SIZE	 Thickness	 Pcs/Box	 Mq/Box	 Kg/Box	 Box/Pallet	 Mq/Pallet	 Kg/Pallet
60x60 / 24"x24" rett.	59,6x59,6	9	3	1,08	21,20	40	43,20	868

L'unità minima di vendita per tutti gli articoli (fondi, decori e pezzi speciali) è la scatola completa. / The minimum sales quantity for all items (plain tiles, decorations and special trims) is one full box. Pezzi speciali e decori per effetto delle lavorazioni, possono presentare variazioni di tonalità. / Due to working process special trims and decors, may show variation in tonality.

## SIGILLANTI COORDINATI PER FUGHE / COORDINATED GROUT SEALANTS

**HARDKOLL**

CODICE SIGILLANTE SEALANT CODE	ABBINAMENTO MATCHING
SI219B kromos grigio cemento 0-8	Papier grigio
SI220B kromos antracite 0-8	Papier antracite
SI217M kromos grigio luce 0-8	Papier corda
SI218B kromos manhattan 0-8	Papier nocciola



# EVOLUTION

## GRES PORCELLANATO A MASSA COLORATA

FULL BODY COLOURED PORCELAIN STONEWARE

CLASSIFICAZIONE SECONDO NORME  
UNI EN 14411 (ISO 13006) ALLEGATO G-Gruppo B1a  
CLASSIFICATION IN ACCORDANCE  
WITH UNI EN 14411 (ISO 13006) ANNEX G-Group B1a

## SUPERFICI E FINITURE

SURFACES AND FINISHES

Satinato naturale / Satin natural  
Satinato rettificato / Satin rectified  
Lappato rettificato / Honed rectified

## FORMATI

SIZES





# EVOLUTION

CAFFÉ

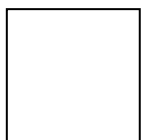
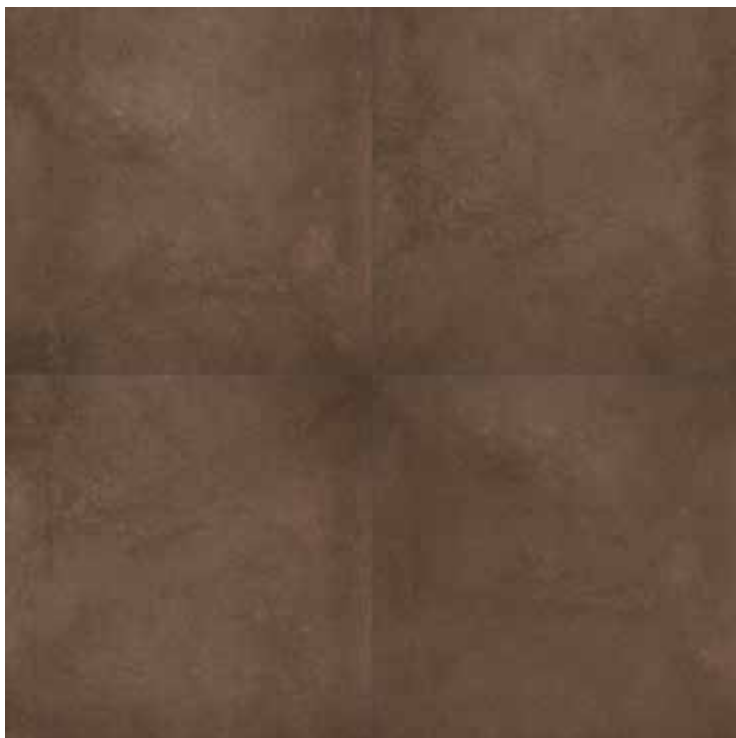

60x60  3  
EVOLUTION CAFFÉ

**EEN3250C** satinato nat. F 46,90

**EES3250D** satinato rett. F 53,90

**EEL3250D** lappato rett. F 64,90



30x60  6  
EVOLUTION CAFFÉ

**EES3750D** satinato rett. F 49,90

**EEL3750D** lappato rett. F 59,90



50x50  4  
EVOLUTION CAFFÉ

**EEN300B** satinato nat. F 38,90

**EES300A** satinato rett. F 46,90



33,3x50  6  
EVOLUTION CAFFÉ

**EES650** satinato rett. F 46,90

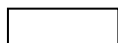

16,65x50  12  
EVOLUTION CAFFÉ

**EES2750A** satinato rett. F 55,90



33,3x33,3  11  
EVOLUTION CAFFÉ

**EEN1250C** satinato nat. F 36,90

**EES1250** satinato rett. F 42,90



11x33,3  33  
EVOLUTION CAFFÉ

**EES1550** satinato rett. F 57,90

COORDINATI DA RIVESTIMENTO / WALL COORDINATED DECORS

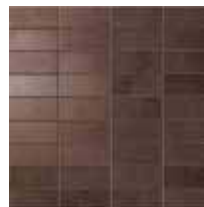

33,3x33,3  5  
MOS. RETTANGOLI CAFFÉ

**EES1270** sat. rett. PZ 21,90



33,3x33,3  5  
MOS. STICKS CAFFÉ

**EES1273** sat. rett. PZ 22,90



33,3x33,3  5  
MOS. MET. RIP. CAFFÉ

**EES1272** sat. rett. PZ 15,90



33,3x33,3  5  
MOS. METALLO CAFFÉ

**EES1271** sat. rett. PZ 32,90

# EVOLUTION

## AVORIO

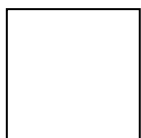

60x60  3  
EVOLUTION AVORIO

**EEN3150C** satinato nat. F 46,90

**EES3150D** satinato rett. F 53,90

**EEL3150D** lappato rett. F 64,90



30x60  6  
EVOLUTION AVORIO

**EES3650D** satinato rett. F 49,90

**EEL3650D** lappato rett. F 59,90



50x50  4  
EVOLUTION AVORIO

**EEN200B** satinato nat. F 38,90

**EES200A** satinato rett. F 46,90

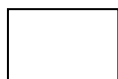

33,3x50  6  
EVOLUTION AVORIO

**EES550** satinato rett. F 46,90

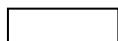

16,65x50  12  
EVOLUTION AVORIO

**EES2650A** satinato rett. F 55,90



33,3x33,3  11  
EVOLUTION AVORIO

**EEN1150C** satinato nat. F 36,90

**EES1150** satinato rett. F 42,90



11x33,3  33  
EVOLUTION AVORIO

**EES1450** satinato rett. F 57,90

### COORDINATI DA RIVESTIMENTO / WALL COORDINATED DECORS



33,3x33,3  5  
MOS. RETTANGOLI AVORIO

**EES1170** sat. rett. PZ 21,90



33,3x33,3  5  
MOS. STICKS AVORIO

**EES1173** sat. rett. PZ 22,90



33,3x33,3  5  
MOS. MET. RIP. AVORIO

**EES1172** sat. rett. PZ 15,90



33,3x33,3  5  
MOS. METALLO AVORIO

**EES1171** sat. rett. PZ 32,90

# EVOLUTION

## TORTORA



### COORDINATI DA RIVESTIMENTO / WALL COORDINATED DECORS



33,3x33,3  5  
MOS. RETTANGOLI TORTORA  
**EES1020** sat. rett. PZ 21,90



33,3x33,3  5  
MOS. STICKS TORTORA  
**EES1023** sat. rett. PZ 22,90



33,3x33,3  5  
MOS. MET. RIP. TORTORA  
**EES1022** sat. rett. PZ 15,90



33,3x33,3  5  
MOS. METALLO TORTORA  
**EES1021** sat. rett. PZ 32,90



60x60  3  
EVOLUTION TORTORA

**EEN3000C** satinato nat. F 46,90

**EES3000D** satinato rett. F 53,90

**EEL3000D** lappato rett. F 64,90



33,3x50  6  
EVOLUTION TORTORA  
**EES400** satinato rett. F 46,90

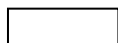

16,65x50  12  
EVOLUTION TORTORA  
**EES2500A** satinato rett. F 55,90

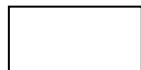

30x60  6  
EVOLUTION TORTORA

**EES3500D** satinato rett. F 49,90

**EEL3500D** lappato rett. F 59,90



33,3x33,3  11  
EVOLUTION TORTORA

**EEN1000C** satinato nat. F 36,90

**EES1000** satinato rett. F 42,90

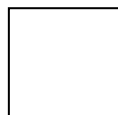

50x50  4  
EVOLUTION TORTORA

**EEN050B** satinato nat. F 38,90

**EES050A** satinato rett. F 46,90



11x33,3  33  
EVOLUTION TORTORA

**EES1300** satinato rett. F 57,90

# EVOLUTION

## FUMO

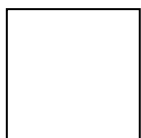

60x60  3  
EVOLUTION FUMO

**EEN3100C** satinato nat. F 46,90

**EES3100D** satinato rett. F 53,90

**EEL3100D** lappato rett. F 64,90



30x60  6  
EVOLUTION FUMO

**EES3600D** satinato rett. F 49,90

**EEL3600D** lappato rett. F 59,90

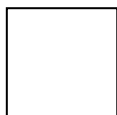

50x50  4  
EVOLUTION FUMO

**EEN150B** satinato nat. F 38,90

**EES150A** satinato rett. F 46,90

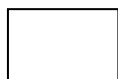

33,3x50  6  
EVOLUTION FUMO

**EES500** satinato rett. F 46,90

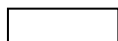

16,65x50  12  
EVOLUTION FUMO

**EES2600A** satinato rett. F 55,90



33,3x33,3  11  
EVOLUTION FUMO

**EEN1100C** satinato nat. F 36,90

**EES1100** satinato rett. F 42,90



11x33,3  33  
EVOLUTION FUMO

**EES1400** satinato rett. F 57,90

## COORDINATI DA RIVESTIMENTO / WALL COORDINATED DECORS



33,3x33,3  5  
MOS. RETTANGOLI FUMO

**EES1120** sat. rett. PZ 21,90



33,3x33,3  5  
MOS. STICKS FUMO

**EES1123** sat. rett. PZ 22,90



33,3x33,3  5  
MOS. MET. RIP. FUMO

**EES1122** sat. rett. PZ 15,90



33,3x33,3  5  
MOS. METALLO FUMO

**EES1121** sat. rett. PZ 32,90

# EVOLUTION

## CARBONE

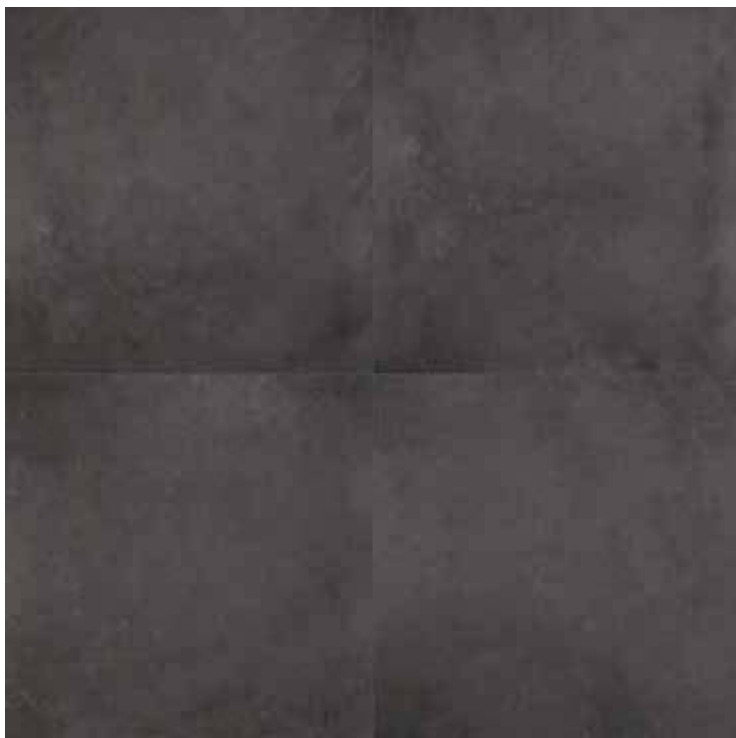

60x60  3

EVOLUTION CARBONE

**EEN3050C** satinato nat. F 46,90

**EES3050D** satinato rett. F 53,90

**EEL3050D** lappato rett. F 64,90



30x60  6

EVOLUTION CARBONE

**EES3550D** satinato rett. F 49,90

**EEL3550D** lappato rett. F 59,90





50x50  4

EVOLUTION CARBONE

**EEN100B** satinato nat. F 38,90

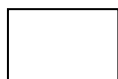
**EES100A** satinato rett. F 46,90



33,3x50  6

EVOLUTION CARBONE

**EES450** satinato rett. F 46,90

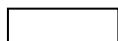

16,65x50  12

EVOLUTION CARBONE

**EES2550A** satinato rett. F 55,90



33,3x33,3  11

EVOLUTION CARBONE

**EEN1050C** satinato nat. F 36,90

**EES1050** satinato rett. F 42,90



11x33,3  33

EVOLUTION CARBONE

**EES1350** satinato rett. F 57,90

## COORDINATI DA RIVESTIMENTO / WALL COORDINATED DECORS



33,3x33,3  5

MOS. RETTANGOLI CARBONE

**EES1070** sat. rett. PZ 21,90



33,3x33,3  5

MOS. STICKS CARBONE

**EES1073** sat. rett. PZ 22,90



33,3x33,3  5

MOS. MET. RIP. CARBONE

**EES1072** sat. rett. PZ 15,90



33,3x33,3  5

MOS. METALLO CARBONE

**EES1071** sat. rett. PZ 32,90

# EVOLUTION



11x33,3 12  
FORMELLA CHIC ANTRACITE  
EES1319 rett. PZ 30,90



4x33,3 12  
LIST. CHIC ANTRACITE  
EES1315 rett. PZ 17,90



2,5x33,3 12  
CORD. CHIC ANTRACITE  
EES1316 rett. PZ 12,90



\*3x33,3 12  
LIST. NET GRIGIO  
EES1467 rett. PZ 16,90



\*1,5x33,3 24  
CORD. NET GRIGIO  
EES1468 rett. PZ 12,90



\*\*3x33,3 6  
F. MOON TORTORA/CARBONE  
EEL1055 lapp. rett. PZ 24,90



\*\*3x33,3 6  
F. MOON TORTORA/FUMO  
EEL1005 lapp. rett. PZ 24,90



4x33,3 12  
LIST. CHIC BRONZO  
EES1465 rett. PZ 17,90



2,5x33,3 12  
CORD. CHIC BRONZO  
EES1466 rett. PZ 12,90



\*3x33,3 12  
LIST. NET PANNA  
EES1317 rett. PZ 16,90



\*1,5x33,3 24  
CORD. NET PANNA  
EES1318 rett. PZ 12,90



\*\*3x33,3 6  
F. MOON AVORIO/OLIVA  
EEL1155 lapp. rett. PZ 24,90



\*\*3x33,3 6  
F. MOON BEIGE/CAFFÉ  
EEL1755 lapp. rett. PZ 24,90



3x33,3 6  
FASCIA URBAN (alluminio - aluminium)  
EES1001 rett. PZ 15,90



1,5x33,3 12  
LIST. URBAN (alluminio - aluminium)  
EES1301 rett. PZ 13,90



5x5 12  
TOZZ. URBAN (alluminio - aluminium)  
EES1003 rett. PZ 6,90



1x33,3 12  
MATITA SPEED PLATINO (vetro - glass)  
EES1560 rett. PZ 21,90



1x33,3 12  
MATITA SPEED ROSSO (vetro - glass)  
EES1310 rett. PZ 21,90

\* Dec. soggetto a stonizzazione.  
Colour-shaded decorative tile.

\*\* Decoro realizzato in vetro, porcellanato, legno e alluminio  
Decorative piece in glass, porcelain stoneware, wood  
and aluminium











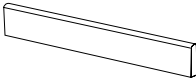

# EVOLUTION

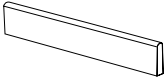
Caffè 33,3x33,3 satinato rett.





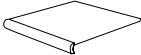



# EVOLUTION

## PEZZI SPECIALI / SPECIAL TRIMS

		CAFFÈ	AVORIO	TORTORA	FUMO	CARBONE
	BATTISCOPIA sat. nat. 10x60 PZ 7,90  10	<b>EEN3251S</b>	<b>EEN3151S</b>	<b>EEN3001S</b>	<b>EEN3101S</b>	<b>EEN3051S</b>
	BATTISCOPIA sat. rett. 10x60 PZ 7,90  10	<b>EES3252</b>	<b>EES3152</b>	<b>EES3002</b>	<b>EES3102</b>	<b>EES3052</b>
	BATTISCOPIA sat. nat. 10x50 PZ 5,90  12	<b>EEN308S</b>	<b>EEN208S</b>	<b>EEN058S</b>	<b>EEN158S</b>	<b>EEN108S</b>
	BATTISCOPIA sat. rett. 10x50 PZ 5,90  12	<b>EES308S</b>	<b>EES208S</b>	<b>EES058S</b>	<b>EES158S</b>	<b>EES108S</b>
	BATTISCOPIA sat. nat. 8x33,3 PZ 3,90  18	<b>EEN1274</b>	<b>EEN1174</b>	<b>EEN1024</b>	<b>EEN1124</b>	<b>EEN1074</b>
	BATTISCOPIA sat. rett. 8x33,3 PZ 3,90  18	<b>EES1274</b>	<b>EES1174</b>	<b>EES1024</b>	<b>EES1124</b>	<b>EES1074</b>
	GRAD. TOR. sat. rett. 33,3x33,3 PZ 23,90  6	<b>EES1276</b>	<b>EES1176</b>	<b>EES1026</b>	<b>EES1126</b>	<b>EES1076</b>

## IMBALLI / PACKAGING

FORMATO NOMINALE NOMINAL SIZE	FORMATO REALE REAL SIZE	 Thickness	 Pcs/Box	 Mq/Box	 Kg/Box	 Box/Pallet	 Mq/Pallet	 Kg/Pallet
60x60 / 24"x24" nat./rett.	59,6x59,6 rett.	9	3	1,08	21,20	40	43,20	868
30x60 / 12"x24" rett.	29,7x59,6	9	6	1,08	21,20	40	43,20	868
50x50 / 20"x20" nat./rett.	49,3x49,3 rett.	9	4	1,00	20,00	36	36,00	740
33,3x50 / 13"x20" rett.	32,8x49,3	9	6	1,00	20,40	44	44,00	918
33,3x33,3 / 13"x13" nat.	-	9	11	1,22	24,00	44	53,68	1076
33,3x33,3 / 13"x13" rett.	32,8x32,8	9	11	1,22	24,00	40	48,80	1076
16,65x50 / 6.5"x20" rett.	16,3x49,3	9	12	1,00	20,40	36	36,00	755
11x33,3 / 4.3"x13" rett.	10,8x32,8	9	33	1,22	24,00	36	43,92	884

L'unità minima di vendita per tutti gli articoli (fondi, decori e pezzi speciali) è la scatola completa. / The minimum sales quantity for all items (plain tiles, decorations and special trims) is one full box. Pezzi speciali e decori per effetto delle lavorazioni, possono presentare variazioni di tonalità. / Due to working process special trims and decors, may show variation in tonality.

## SIGILLANTI COORDINATI PER FUGHE / COORDINATED GROUT SEALANTS

**HARD KOLL**

CODICE SIGILLANTE SEALANT CODE	ABBINAMENTO MATCHING
SI271S kromos tortora 0-8	Evolution tortora
SI274S kromos carbone 0-8	Evolution carbone
SI272S kromos fumo 0-8	Evolution fumo
SI270S kromos avorio 0-8	Evolution avorio
SI273S kromos cacao 0-8	Evolution caffè

# DOLPHIN

## GRES PORCELLANATO A MASSA COLORATA

FULL BODY COLOURED PORCELAIN STONEWARE

CLASSIFICAZIONE SECONDO NORME  
UNI EN 14411 (ISO 13006) ALLEGATO G-Gruppo Bla GL  
CLASSIFICATION IN ACCORDANCE  
WITH UNI EN 14411 (ISO 13006) ANNEX G-Group Bla GL

## SUPERFICI E FINITURE

SURFACES AND FINISHES

Naturale rettificato / Natural rectified  
Aged rettificato / Structured rectified

## FORMATI

SIZES

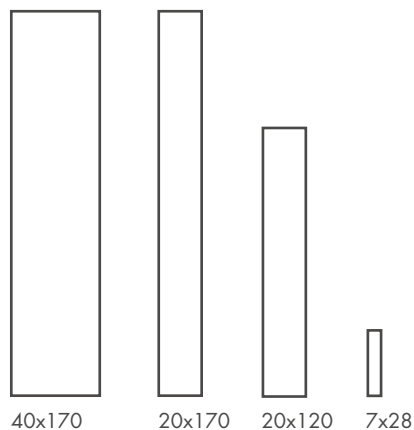

**AUTO-LEVELING**  
Facile installazione - Easy laying

**INSTA-TILE**  
DRY FIXING

( pag. 310 - 311 )



one  
must  
dash



i fall in  
love  
all over  
again





(esterno) dolphin oak aged 20x120 - grey aged 20x120 - (interno) oak 20x120



# DOLPHIN

MILK



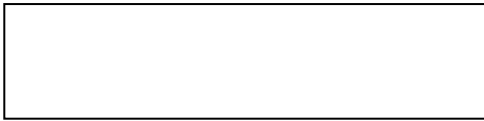



40x170  2  
DOLPHIN MILK  
**DPR56050** rett. F 91,90

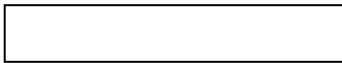

20x170  3  
DOLPHIN MILK  
**DPR55050** rett. F 91,90



20x120  4  
DOLPHIN MILK  
**DPR35050** rett. F 68,90

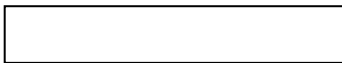

20x120  4  
DOLPHIN MILK  
**DPR35500** aged rett. F 68,90

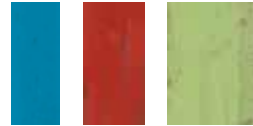

20x15  6  
SNIP PAINT MIX 6 (5x20+10x20+15x20)  
**DPR35106** rett. PZ 119,90  
(prezzo a cp.)



# DOLPHIN

CLAY



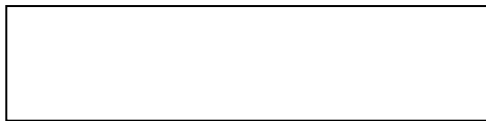

40x170  2  
DOLPHIN CLAY  
**DPR56100** rett. F 91,90

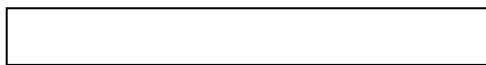

20x170  3  
DOLPHIN CLAY  
**DPR55100** rett. F 91,90



20x120  4  
DOLPHIN CLAY  
**DPR35100** rett. F 68,90

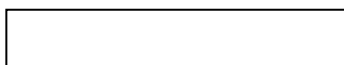

20x120  4  
DOLPHIN CLAY  
**DPR35650** aged rett. F 68,90



20x15  6  
SNIP PAINT MIX 6 (5x20+10x20+15x20)  
**DPR35106** rett. PZ 119,90  
(prezzo a cp.)





20x120  3  
LISTONE CLAY PAINT MIX 3  
**DPR35105** rett. PZ 85,90

# DOLPHIN

OAK

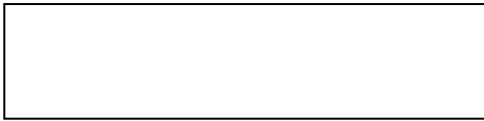





40x170  2  
DOLPHIN OAK  
DPR56150 rett. F 91,90

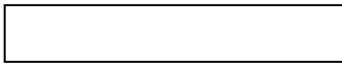

20x170  3  
DOLPHIN OAK  
DPR55160 rett. F 91,90



20x120  4  
DOLPHIN OAK  
DPR35150 rett. F 68,90

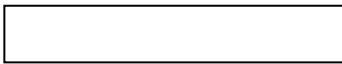

20x120  4  
DOLPHIN OAK  
DPR35550 aged rett. F 68,90



7x28  50  
DOLPHIN OAK SESTINO  
DPR35160 rett. F 99,90



20x15  6  
SNIP PAINT MIX 6 (5x20+10x20+15x20)  
DPR35106 rett. PZ 119,90  
(prezzo a cp.)

**DOLPHIN**

MOON



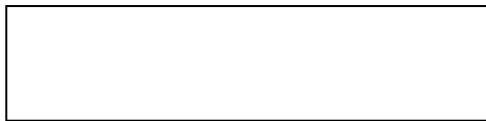

40x170  2  
DOLPHIN MOON  
**DPR56200** rett. F 91,90

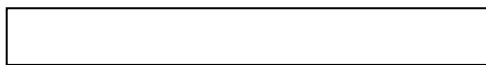

20x170  3  
DOLPHIN MOON  
**DPR55200** rett. F 91,90



20x120  4  
DOLPHIN MOON  
**DPR35200** rett. F 68,90

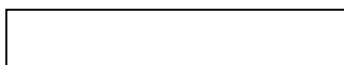

20x120  4  
DOLPHIN MOON  
**DPR35700** aged rett. F 68,90



20x15  6  
SNIP PAINT MIX 6 (5x20+10x20+15x20)  
**DPR35106** rett. PZ 119,90  
(prezzo a cp.)





20x120  3  
LISTONE GREY ENAMEL MIX 3  
**DPR35255** rett. PZ 85,90

# DOLPHIN

GREY

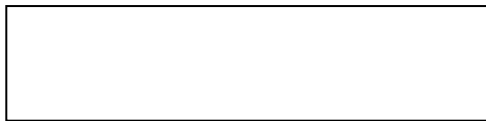



40x170  2  
DOLPHIN GREY  
**DPR56250** rett. F 91,90



20x170  3  
DOLPHIN GREY  
**DPR55250** rett. F 91,90



20x120  4  
DOLPHIN GREY  
**DPR35250** rett. F 68,90

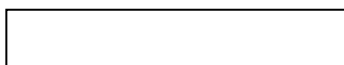

20x120  4  
DOLPHIN GREY  
**DPR35600** aged rett. F 68,90



20x15  6  
SNIP PAINT MIX 6 (5x20+10x20+15x20)  
**DPR35106** rett. PZ 119,90  
(prezzo a cp.)



20x120  3  
LISTONE GREY ENAMEL MIX 3  
**DPR35255** rett. PZ 85,90



# DOLPHIN

COAL



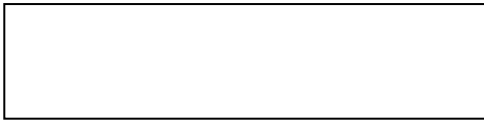



40x170  2  
DOLPHIN COAL  
**DPR56300** rett. F 91,90

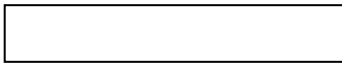

20x170  3  
DOLPHIN COAL  
**DPR55300** rett. F 91,90



20x120  4  
DOLPHIN COAL  
**DPR35300** rett. F 68,90

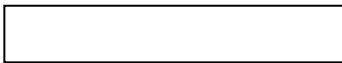

20x120  4  
DOLPHIN COAL  
**DPR35750** aged rett. F 68,90



7x28  50  
DOLPHIN COAL SESTINO  
**DPR35310** rett. F 99,90

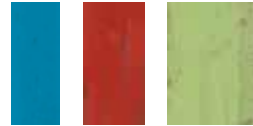
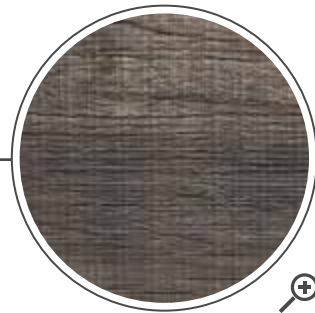

20x15  6  
SNIP PAINT MIX 6 (5x20+10x20+15x20)  
**DPR35106** rett. PZ 119,90  
(prezzo a cp.)

## SCHEMA DI POSA / INSTALLATION PATTERNS

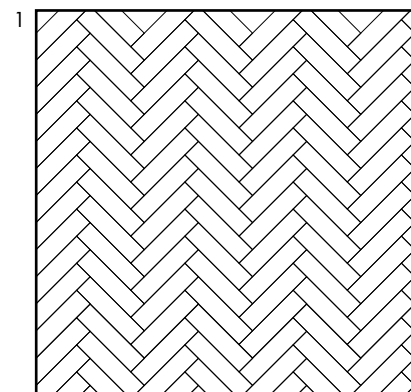

7x28 SESTINO

100 %

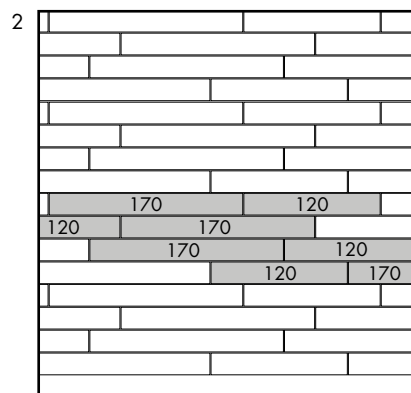

20x120

41,40 %

20x170

58,60 %

( MODULO FISSO )

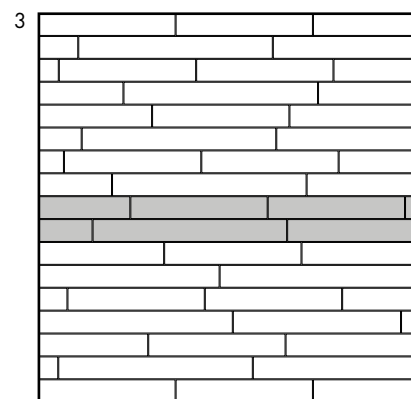

20x120

50 %

20x170

50 %

( A FILE ALTERNATE )





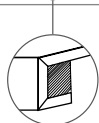

# DOLPHIN

## PEZZI SPECIALI / SPECIAL TRIMS

	MILK	CLAY	OAK	MOON	GREY	COAL
 BATTISCOPA rett. 6,5x120 PZ 10,90  6	DPR35051	DPR35101	DPR35151	DPR35201	DPR35251	DPR35301
 ELEMENTO L 15x60x4 PZ 45,90  4	DPR35501 MILK AGED	DPR35651 CLAY AGED	DPR35551 OAK AGED	DPR35701 MOON AGED	DPR35601 GREY AGED	DPR35751 COAL AGED
 GRADONE TOP rett. 32x120x3x3 PZ 172,90  1	DPR35052	DPR35102	DPR35152	DPR35202	DPR35252	DPR35302



## IMBALLI / PACKAGING

FORMATO NOMINALE NOMINAL SIZE	FORMATO REALE REAL SIZE	 Thickness	 Pcs/Box	 Mq/Box	 Kg/Box	 Box/Pallet	 Mq/Pallet	 Kg/Pallet
40x170 / 16"x68" rett.	40x170	9	2	1,36	27,00	28	38,08	800
20x170 / 8"x68" rett.	19,9x170	9	3	1,02	21,00	42	42,84	900
20x120 / 8"x48" rett.	19,9x119,4	9	4	0,96	18,20	54	51,84	1008
7x28 / 3"x11" rett.	-	9	50	0,98	19,00	-	-	-

L'unità minima di vendita per tutti gli articoli (fondi, decori e pezzi speciali) è la scatola completa. / The minimum sales quantity for all items (plain tiles, decorations and special trims) is one full box. Pezzi speciali e decori per effetto delle lavorazioni, possono presentare variazioni di tonalità. / Due to working process special trims and decors, may show variation in tonality.

## SIGILLANTI COORDINATI PER FUGHE / COORDINATED GROUT SEALANTS

**HARD KOLL**

CODICE SIGILLANTE SEALANT CODE	ABBINAMENTO MATCHING
SI218B kromos manhattan 0-8	Dolphin moon / grey / milk
SI220B kromos antracite 0-8	Dolphin coal/ oak
SI238B kromos tabacco 0-8	Dolphin clay

# SOLERAS

## GRES PORCELLANATO A MASSA COLORATA

FULL BODY COLOURED PORCELAIN STONEWARE

CLASSIFICAZIONE SECONDO NORME  
UNI EN 14411 (ISO 13006) ALLEGATO G-Gruppo Bla GL  
CLASSIFICATION IN ACCORDANCE  
WITH UNI EN 14411 (ISO 13006) ANNEX G-Group Bla GL

## SUPERFICI E FINITURE

SURFACES AND FINISHES

Naturale rettificato / Natural rectified  
Grip rettificato / Structured rectified

## FORMATI

SIZES

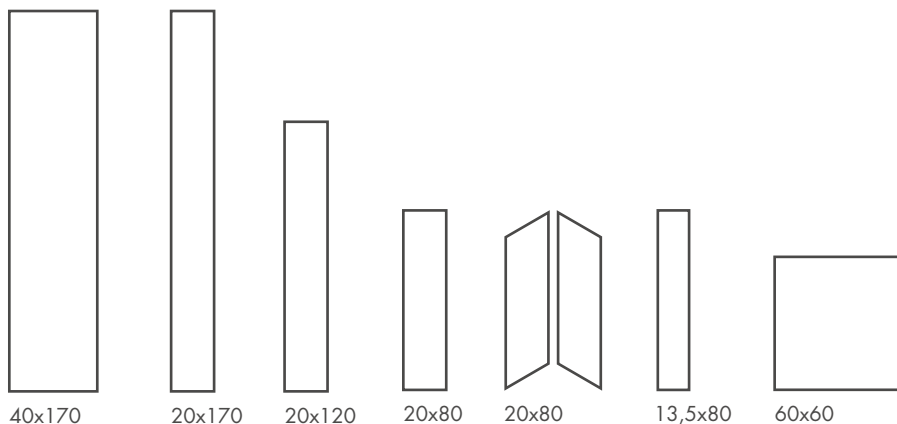

**AUTO-LEVELING**  
Facile installazione - Easy laying

**INSTA-TILE**  
DRY FIXING

( pag. 310 - 311 )









**SOLERAS**

NATURALE







40x170  2  
SOLERAS NATURALE  
**S1R56200** rett. F 91,90

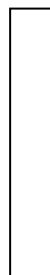

20x170  3  
SOLERAS NATURALE  
**S1R55200** rett. F 91,90



20x120  4  
SOLERAS NATURALE  
**S1R35200** rett. F 68,90



20x80  7  
SOLERAS NATURALE  
**S1R4920A** rett. F 57,90



13,5x80  10  
SOLERAS NATURALE  
**S1R48200** rett. F 62,90

20x80  7  
SOLERAS NATURALE GRIP  
**S1R49650** rett. F 57,90



5x40  4  
\*LISTELLO WOOD  
**DKR51055** rett. PZ 19,90

\*Antico legno alpino recuperato da costruzioni dismesse e trattato per l'utilizzo in parete e a pavimento.

**Ogni pezzo è unico e irripetibile.**  
Antique alpin wood, recovered from discontinued buildings and treated for floor and wall use. Every single piece turns out to be different and unique.

# SOLERAS

BEIGE





20x120  4  
SOLERAS BEIGE  
**S1R35300** rett. F 68,90



20x80  7  
SOLERAS BEIGE  
**S1R4930A** rett. F 57,90



13,5x80  10  
SOLERAS BEIGE  
**S1R48300** rett. F 62,90



5x40  4  
**\*LISTELLO WOOD**  
**DKR51055** rett. PZ 19,90

\*Antico legno alpino recuperato da costruzioni dismesse e trattato per l'utilizzo in parete e a pavimento.

**Ogni pezzo è unico e irripetibile.**  
Antique alpin wood, recovered from discontinued buildings and treated for floor and wall use. Every single piece turns out to be different and unique.

**SOLERAS**

AVANA





40x170 2  
SOLERAS AVANA  
**S1R56250** rett. F 91,90



20x170 3  
SOLERAS AVANA  
**S1R55250** rett. F 91,90

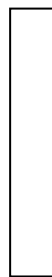

20x120 4  
SOLERAS AVANA  
**S1R35250** rett. F 68,90



20x80 7  
SOLERAS AVANA  
**S1R4925A** rett. F 57,90



13,5x80 10  
SOLERAS AVANA  
**S1R48250** rett. F 62,90

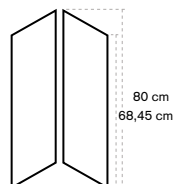

20x80 6  
SOLERAS AVANA FRENCH PATTERN  
**S1R49260** rett. F 91,90



20x80 7  
SOLERAS AVANA GRIP  
**S1R49700** rett. F 57,90

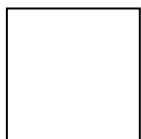

60x60 3  
SOLERAS AVANA  
**S1R01250** rett. F 53,90



5x80 4  
LIST. SOLERAS AVANA  
**S1R49255** rett. PZ 6,90



5x40 4  
\*LISTELLO WOOD  
**DKR51055** rett. PZ 19,90

\*Antico legno alpino recuperato da costruzioni dismesse e trattato per l'utilizzo in parete e a pavimento.

Ogni pezzo è unico e irripetibile.

Antique alpin wood, recovered from discontinued buildings and treated for floor and wall use. Every single piece turns out to be different and unique.



5x60 8  
LISTONE BEIGE  
**S1R01255** rett. F 104,90



5x5 8  
TOZZETTO BEIGE  
**S1R01256** rett. F 104,90

**SOLERAS**

BIANCO





40x170  2  
 SOLERAS BIANCO  
**S1R56050** rett. F 91,90



20x170  3  
 SOLERAS BIANCO  
**S1R55050** rett. F 91,90

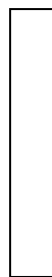

20x120  4  
 SOLERAS BIANCO  
**S1R35050** rett. F 68,90



20x80  7  
 SOLERAS BIANCO  
**S1R4905A** rett. F 57,90

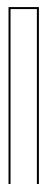

13,5x80  10  
 SOLERAS BIANCO  
**S1R48050** rett. F 62,90

20x80  7  
 SOLERAS BIANCO GRIP  
**S1R49500** rett. F 57,90



5x40  4  
 \*LISTELLO WOOD  
**DKR51055** rett. PZ 19,90

\*Antico legno alpino recuperato da costruzioni dismesse e trattato per l'utilizzo in parete e a pavimento.

**Ogni pezzo è unico e irripetibile.**  
 Antique alpin wood, recovered from discontinued buildings and treated for floor and wall use. Every single piece turns out to be different and unique.



# SOLERAS

GRIGIO





40x170 2  
SOLERAS GRIGIO  
**S1R56100** rett. F 91,90



20x170 3  
SOLERAS GRIGIO  
**S1R55100** rett. F 91,90

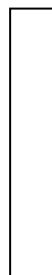

20x120 4  
SOLERAS GRIGIO  
**S1R35100** rett. F 68,90



20x80 7  
SOLERAS GRIGIO  
**S1R4910A** rett. F 57,90



13,5x80 10  
SOLERAS GRIGIO  
**S1R48100** rett. F 62,90

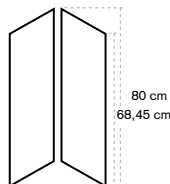

20x80 6  
SOLERAS GRIGIO FRENCH PATTERN  
**S1R49110** rett. F 91,90

20x80 7  
SOLERAS GRIGIO GRIP  
**S1R49550** rett. F 57,90

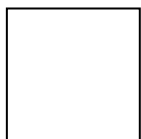

60x60 3  
SOLERAS GRIGIO  
**S1R01100** rett. F 53,90



5x40 4  
\*LISTELLO WOOD  
**DKR51055** rett. PZ 19,90

\*Antico legno alpino recuperato da costruzioni dismesse e trattato per l'utilizzo in parete e a pavimento.

Ogni pezzo è unico e irripetibile.  
Antique alpin wood, recovered from discontinued buildings and treated for floor and wall use. Every single piece turns out to be different and unique.



5x60 8  
LISTONE GRIGIO  
**S1R01105** rett. F 104,90





5x5 8  
TOZZETTO GRIGIO  
**S1R01106** rett. F 104,90

**SOLERAS**

ANTRACITE

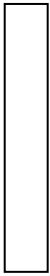



20x120  4  
SOLERAS ANTRACITE  
**S1R35150** rett. F 68,90

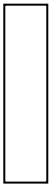

20x80  7  
SOLERAS ANTRACITE  
**S1R4915A** rett. F 57,90



13,5x80  10  
SOLERAS ANTRACITE  
**S1R48150** rett. F 62,90



5x80  4  
LIST. SOLERAS ANTRACITE  
**S1R49155** rett. PZ 6,90



5x40  4  
\*LISTELLO WOOD  
**DKR51055** rett. PZ 19,90

\*Antico legno alpino recuperato da costruzioni dismesse e trattato per l'utilizzo in parete e a pavimento.

**Ogni pezzo è unico e irripetibile.**

Antique alpin wood, recovered from discontinued buildings and treated for floor and wall use. Every single piece turns out to be different and unique.

# SOLERAS

## SCHEMA DI POSA / INSTALLATION PATTERNS

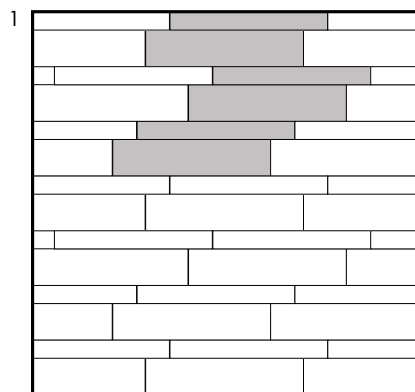

40x170	66,7 %
20x170	33,3 %

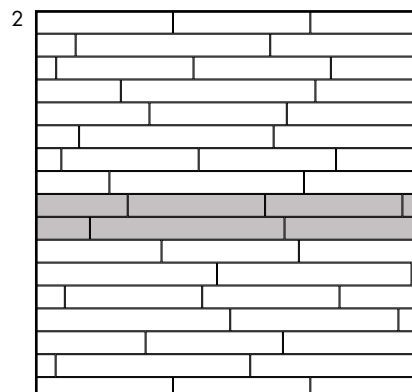

20x170	50 %
20x120	50 %

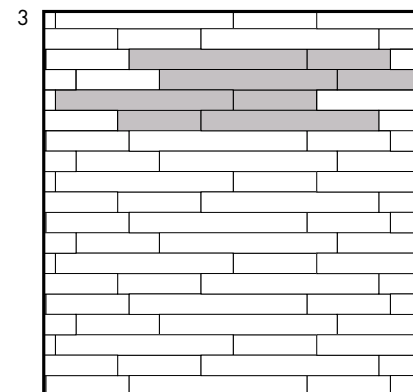

20x170	68 %
20x80	32 %

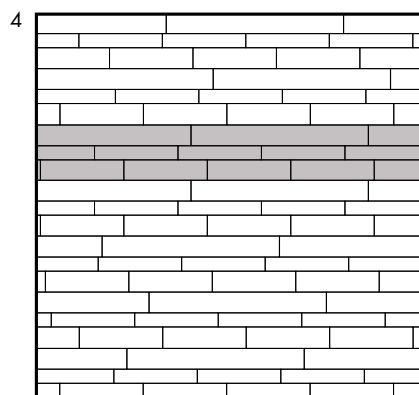

20x170	37,5 %
20x80	37,5 %
13,5x80	25,0 %

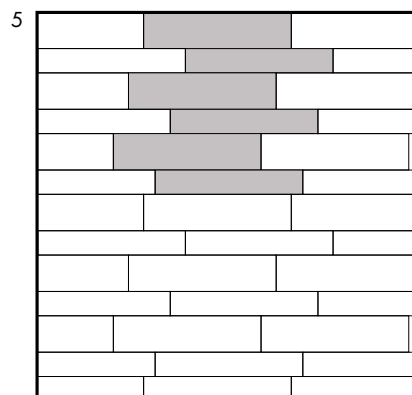

20x80	59,7 %
13,5x80	40,3 %

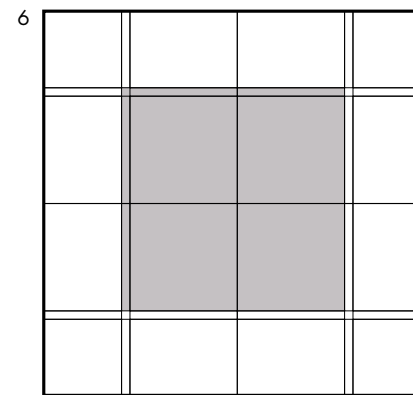







60x60	92,16 %
5x60 LISTONE	7,68 %
5x5 TOZZETTO	0,16 %

# SOLERAS

## PEZZI SPECIALI / SPECIAL TRIMS

	NATURALE	BEIGE	AVANA	BIANCO	GRIGIO	ANTRACITE
 GRADONE TOP rett. 32x120x3x3 PZ 172,90  1	<b>S1R55202</b>	<b>S1R55302</b>	<b>S1R55252</b>	<b>S1R55052</b>	<b>S1R55102</b>	<b>S1R55152</b>
 BATTISCOPA 6,5x80 PZ 8,90  8	<b>S1R49201</b>	<b>S1R49301</b>	<b>S1R49251</b>	<b>S1R49051</b>	<b>S1R49101</b>	<b>S1R49151</b>
 COMP. SCALINO rett. 35x80x4 PZ 82,90 (prezzo a comp.)  1 cp/box	<b>S1R49206</b>	<b>S1R49306</b>	<b>S1R49256</b>	<b>S1R49056</b>	<b>S1R49106</b>	<b>S1R49156</b>
 AE rett. 12,5x40x3 PZ 27,90  4	<b>S1R49207</b>	<b>S1R49307</b>	<b>S1R49257</b>	<b>S1R49057</b>	<b>S1R49107</b>	<b>S1R49157</b>

## IMBALLI / PACKAGING

FORMATO NOMINALE NOMINAL SIZE	FORMATO REALE REAL SIZE	 Thickness	 Pcs/Box	 Mq/Box	 Kg/Box	 Box/Pallet	 Mq/Pallet	 Kg/Pallet
40x170 / 16"x68" rett.	40x170	9	2	1,36	27,00	28	38,08	800
20x170 / 8"x68" rett.	19,9x170	9	3	1,02	21,00	42	42,84	900
20x120 / 8"x48" rett.	19,9x119,4	9	4	0,96	18,20	54	51,84	1008
20x80 / 8"x32" rett.	19,9x80	9	7	1,12	21,00	42	47,04	1002
20x80 / 8"x32" French Pattern	19,9x80	9	6	0,82	17,38	30	24,60	542
13,5x80 / 5.3"x32" rett.	13,2x80	9	10	1,08	20,00	40	43,20	820
60x60 / 24"x24" rett.	59,6x59,6	9	3	1,08	21,20	40	43,20	868

L'unità minima di vendita per tutti gli articoli (fondi, decori e pezzi speciali) è la scatola completa. / The minimum sales quantity for all items (plain tiles, decorations and special trims) is one full box. Pezzi speciali e decori per effetto delle lavorazioni, possono presentare variazioni di tonalità. / Due to working process special trims and decors, may show variation in tonality.

## SIGILLANTI COORDINATI PER FUGHE / COORDINATED GROUT SEALANTS

**HARDKOLL**

CODICE SIGILLANTE SEALANT CODE	ABBINAMENTO MATCHING
SI217M kromos grigio luce 0-8	Soleras bianco
SI218B kromos manhattan 0-8	Soleras grigio
SI220B kromos antracite 0-8	Soleras antracite
SI234B kromos bahama beige 0-8	Soleras naturale
SI234B kromos bahama beige 0-8	Soleras avana
SI234B kromos bahama beige 0-8	Soleras beige

# CABANE

## GRES PORCELLANATO

PORCELAIN STONEWARE

CLASSIFICAZIONE SECONDO NORME  
UNI EN 14411 (ISO 13006) ALLEGATO G-Gruppo Bla GL  
CLASSIFICATION IN ACCORDANCE  
WITH UNI EN 14411 (ISO 13006) ANNEX G-Group Bla GL

## SUPERFICI E FINITURE

SURFACES AND FINISHES

Naturale rettificato / Natural rectified

## FORMATI

SIZES



20x80 13,5x80



CORDA



AVORIO



BIANCO



GRIGIO



DIN 51130  
naturale



DIN 51097  
naturale



ASTM C 1028  
naturale



B.C.R.A.  
naturale



bianco/grigio



avorio/corda









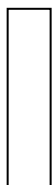

# CABANE

CORDA



20x80  7  
CABANE CORDA  
**CBR4915A** rett. F 57,90

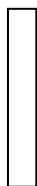

13,5x80  10  
CABANE CORDA  
**CBR48150** rett. F 62,90

AVORIO

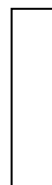

20x80  7  
CABANE AVORIO  
**CBR4910A** rett. F 57,90



13,5x80  10  
CABANE AVORIO  
**CBR48100** rett. F 62,90

## BIANCO



20x80  7  
CABANE BIANCO  
**CBR4905A** rett. F 57,90



13,5x80  10  
CABANE BIANCO  
**CBR48050** rett. F 62,90

## GRIGIO

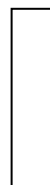

20x80  7  
CABANE GRIGIO  
**CBR4920A** rett. F 57,90



13,5x80  10  
CABANE GRIGIO  
**CBR48200** rett. F 62,90









# CABANE

## PEZZI SPECIALI / SPECIAL TRIMS

					
		CORDA	AVORIO	BIANCO	GRIGIO
	BATTISCOPA rett. 6,5x80 PZ 8,90  8	<b>CBR49151</b>	<b>CBR49101</b>	<b>CBR49051</b>	<b>CBR49201</b>
	COMP. SCALINO rett. 35x80x4 PZ 82,90 (prezzo a comp.)  1cp/box	<b>CBR49155</b>	<b>CBR49105</b>	<b>CBR49055</b>	<b>CBR49205</b>

## IMBALLI / PACKAGING

FORMATO NOMINALE NOMINAL SIZE	FORMATO REALE REAL SIZE	 Thickness	 Pcs/Box	 Mq/Box	 Kg/Box	 Box/Pallet	 Mq/Pallet	 Kg/Pallet
20x80 / 8"x32" rett.	19,9x80	9	7	1,12	21,00	42	47,04	1002
13,5x80 / 5.3"x32" rett.	13,2x80	9	10	1,08	20,00	40	43,20	820

L'unità minima di vendita per tutti gli articoli (fondi, decori e pezzi speciali) è la scatola completa. / The minimum sales quantity for all items (plain tiles, decorations and special trims) is one full box. Pezzi speciali e decori per effetto delle lavorazioni, possono presentare variazioni di tonalità. / Due to working process special trims and decors, may show variation in tonality.

## SIGILLANTI COORDINATI PER FUGHE / COORDINATED GROUT SEALANTS

**HARD KOLL**

CODICE SIGILLANTE SEALANT CODE	ABBINAMENTO MATCHING
SI232B kromos avorio 0-8	Cabane avorio
SI234B kromos bahama beige 0-8	Cabane corda
SI213B kromos bianco 0-8 SI1 17M kromos grigio luce 0-8	Cabane bianco
SI218B kromos manhattan 0-8	Cabane grigio

# WOODWAY 90

---

## GRES PORCELLANATO

PORCELAIN STONEWARE

CLASSIFICAZIONE SECONDO NORME  
UNI EN 14411 (ISO 13006) ALLEGATO G-Gruppo Bla GL  
CLASSIFICATION IN ACCORDANCE  
WITH UNI EN 14411 (ISO 13006) ANNEX G-Group Bla GL

---

## SUPERFICI E FINITURE

SURFACES AND FINISHES

Naturale rettificato / Natural rectified

---

## FORMATI

SIZES



15x90

---



ROVERE



JATOBÀ



SUCUPIRA



NOCE

---







# WOODWAY 90

ROVERE



15x90  6  
WOODWAY ROVERE  
**WOR45400** rett. F 62,90

JATOBÀ

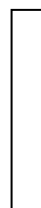

15x90  6  
WOODWAY JATOBÀ  
**WOR45450** rett. F 62,90

## SUCUPIRA



15x90  6  
WOODWAY SUCUPIRA  
**WOR45500** rett. F 62,90

## NOCE

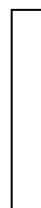

15x90  6  
WOODWAY NOCE  
**WOR45550** rett. F 62,90

# WOODWAY 90

Rovere rett. 15x90







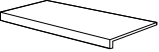

# WOODWAY 90

## PEZZI SPECIALI / SPECIAL TRIMS

PEZZI SPECIALI / SPECIAL TRIMS		ROVERE	JATOBÀ	SUCUPIRA	NOCE
	BATTISCOPA 7,5x45 rett. PZ 7,90 $\boxtimes$ 12	<b>WOR1340S</b>	<b>WOR1345S</b>	<b>WOR1350S</b>	<b>WOR1355S</b>
	GRADINO L 30x90x4 PZ 124,90 $\boxtimes$ 1	<b>WOR45401</b>	<b>WOR45451</b>	<b>WOR45501</b>	<b>WOR45551</b>

## IMBALLI / PACKAGING

FORMATO NOMINALE NOMINAL SIZE	FORMATO REALE REAL SIZE	 Thickness	 Pcs/Box	 Mq/Box	 Kg/Box	 Box/Pallet	 Mq/Pallet	 Kg/Pallet
15x90 / 6"x36" rett.	14,7x89,7	10	6	0,81	19,60	64	51,84	1275

L'unità minima di vendita per tutti gli articoli (fondi, decori e pezzi speciali) è la scatola completa. / The minimum sales quantity for all items (plain tiles, decorations and special trims) is one full box. Pezzi speciali e decori per effetto delle lavorazioni, possono presentare variazioni di tonalità. / Due to working process special trims and decors, may show variation in tonality.

## SIGILLANTI COORDINATI PER FUGHE / COORDINATED GROUT SEALANTS

**HARDKOLL**

CODICE SIGILLANTE SEALANT CODE	ABBINAMENTO MATCHING
SI238B kromos tabacco 0-8	Woodway - rovere
SI134B kromos marrone 0-8	Woodway - sucupira - noce
SI128B kromos cotto 0-8	Woodway - jatobà

# FOSSIL

## GRES PORCELLANATO

PORCELAIN STONEWARE

CLASSIFICAZIONE SECONDO NORME  
UNI EN 14411 (ISO 13006) ALLEGATO G-Gruppo Bla GL  
CLASSIFICATION IN ACCORDANCE  
WITH UNI EN 14411 (ISO 13006) ANNEX G-Group Bla GL

## SUPERFICI E FINITURE

SURFACES AND FINISHES

Naturale / Natural  
Naturale rettificato / Natural rectified  
Lappato rettificato / Honed rectified

## FORMATI

SIZES

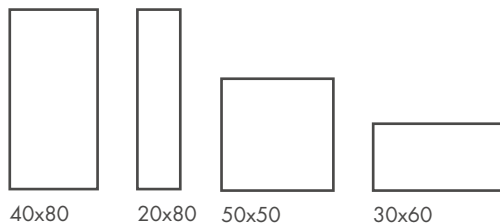









# FOSSIL

LIGHT GREY



DELUXE



40x80  3  
FOSSIL LIGHT GREY

<b>FSR5120C</b>	rett.	F 58,90
<b>FSL5120C</b>	lappato rett.	F 67,90

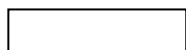

20x80  7  
FOSSIL LIGHT GREY

<b>FSR4920A</b>	rett.	F 67,90
<b>FSL4920A</b>	lappato rett.	F 76,90

5x40  4  
\*LISTELLO WOOD

<b>DKR51055</b>	rett.	PZ 19,90
-----------------	-------	----------

1,5x80  3  
MATITA METAL (alluminio - aluminium)  
**DKR51051** PZ 19,90

BLUE



DELUXE



40x80  3  
FOSSIL BLUE

<b>FSR5125C</b>	rett.	F 58,90
<b>FSL5125C</b>	lappato rett.	F 67,90

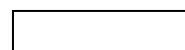

20x80  7  
FOSSIL BLUE

<b>FSR4925A</b>	rett.	F 67,90
<b>FSL4925A</b>	lappato rett.	F 76,90

2x80  3  
LISTELLO FOGLIA ARGENTO

<b>FSR51210</b>	PZ 39,90
-----------------	----------

2x80  3  
LISTELLO FOGLIA ORO  
**FSR51160** PZ 39,90

## BROWN



DELUXE



40x80  3  
FOSSIL BROWN

<b>FSR5115C</b>	rett.	F 58,90
<b>FSL5115C</b>	lappato rett.	F 67,90

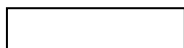

20x80  7  
FOSSIL BROWN

<b>FSR4915A</b>	rett.	F 67,90
<b>FSL4915A</b>	lappato rett.	F 76,90

1,5x30  4  
\*\* FASCIA VETRO ORO

<b>R1R03106</b>	PZ 22,90
-----------------	----------

1,5x30  4  
\*\* FASCIA VETRO BRONZO

<b>R1R03157</b>	PZ 22,90
-----------------	----------

1,5x30  4  
\*\* FASCIA VETRO PLATINO

<b>R1R03207</b>	PZ 22,90
-----------------	----------

## BEIGE



DELUXE

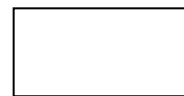

40x80  3  
FOSSIL BEIGE

<b>FSR5110C</b>	rett.	F 58,90
<b>FSL5110C</b>	lappato rett.	F 67,90

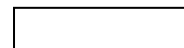

20x80  7  
FOSSIL BEIGE

<b>FSR4910A</b>	rett.	F 67,90
<b>FSL4910A</b>	lappato rett.	F 76,90

\* Antico legno alpino recuperato da costruzioni dismesse e trattato per l'utilizzo in parete e a pavimento.  
Ogni pezzo è unico e irripetibile.  
Antique alpin wood, recovered from discontinued buildings and treated for floor and wall use.  
Every single piece turns out to be different and unique.

\*\* Articoli realizzati in marmo vetro e metalli preziosi; l'utilizzo a pavimento è indicato solo in ambito residenziale.  
Items produced with marble glass and precious metals: the floor use is suitable for residential area only.





# FOSSIL

LIGHT GREY



STONE



30x60   
FOSSIL LIGHT GREY  
**FSN03200** F 38,90



50x50   
FOSSIL LIGHT GREY  
**FSN24200** F 38,90



30x30   
MOS. QUADRETTI FOSSIL LIGHT GREY  
**FSN03210** F 101,90



30x30   
MOS. QUADRETTI FOSSIL MIX L. GREY/BLUE  
**FSN03211** F 101,90



30x30   
MOS. MURETTO FOSSIL LIGHT GREY  
**FSN03215** F 106,90

COORDINATI DA RIVESTIMENTO / WALL COORDINATED DECORS



30x60   
BLEND FOSSIL MIX GREY  
**FSN03550** F 40,90



30x60   
ANGOLARE BLEND FOSSIL MIX GREY  
**FSN03551** PZ 32,90



5x33,3   
\* FASCIA ARS COLD  
**FSN03214** PZ 33,90



1,5x30   
\* FASCIA VETRO PLATINO  
**R1R03207** PZ 22,90



30x30   
MOS. MINI FOSSIL MIX LIGHT GREY/BLUE  
**FSN03216** PZ 26,90

\* Articoli realizzati in marmo vetro e metalli preziosi; l'utilizzo a pavimento è indicato solo in ambito residenziale.  
Items produced with marble glass and precious metals: the floor use is suitable for residential area only.

# FOSSIL

## BLUE



### STONE

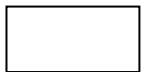

30x60  6  
FOSSIL BLUE  
**FSN03250** F 38,90



50x50  4  
FOSSIL BLUE  
**FSN24250** F 38,90



30x30  6  
MOS. QUADRETTI FOSSIL BLUE  
**FSN03260** F 101,90



30x30  6  
MOS. QUADRETTI FOSSIL MIX L. GREY/BLUE  
**FSN03211** F 101,90



30x30  6  
MOS. MURETTO FOSSIL BLUE  
**FSN03265** F 106,90

### COORDINATI DA RIVESTIMENTO / WALL COORDINATED DECORS



30x60  6  
BLEND FOSSIL MIX GREY  
**FSN03550** F 40,90



30x60  2  
ANGOLARE BLEND FOSSIL MIX GREY  
**FSN03551** PZ 32,90



5x33,3  4  
\* FASCIA ARS COLD  
**FSN03214** PZ 33,90



1,5x30  4  
\* FASCIA VETRO PLATINO  
**R1R03207** PZ 22,90



1,5x30  4  
\* FASCIA VETRO BRONZO  
**R1R03157** PZ 22,90



30x30  4  
MOS. MINI FOSSIL MIX LIGHT GREY/BLUE  
**FSN03216** PZ 26,90

# FOSSIL

BROWN



STONE

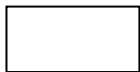

30x60  6  
FOSSIL BROWN  
**FSN03150**

F 38,90



50x50  4  
FOSSIL BROWN  
**FSN24150**

F 38,90



30x30  6  
MOS. QUADRETTI FOSSIL BROWN  
**FSN03160**

F 101,90



30x30  6  
MOS. QUADRETTI FOSSIL MIX CRE/BE/BR.  
**FSN03061**

F 101,90



30x30  6  
MOS. MURETTO FOSSIL BROWN  
**FSN03165**

F 106,90

COORDINATI DA RIVESTIMENTO / WALL COORDINATED DECORS



30x60  6  
BLEND FOSSIL MIX CREAM  
**FSN03500**

F 40,90



30x60  2  
ANGOLARE BLEND FOSSIL MIX CREAM  
**FSN03501**

PZ 32,90



5x33,3  4  
\* FASCIA ARS HOT  
**FSN03064**

PZ 33,90



1,5x30  4  
\* FASCIA VETRO ORO  
**R1R03106**

PZ 22,90



1,5x30  4  
\* FASCIA VETRO BRONZO  
**R1R03157**

PZ 22,90



30x30  4  
MOS. MINI FOSSIL MIX CRE/BE/BR.  
**FSN03066**

PZ 26,90

\* Articoli realizzati in marmo vetro e metalli preziosi; l'utilizzo a pavimento è indicato solo in ambito residenziale.  
Items produced with marble glass and precious metals: the floor use is suitable for residential area only.

# FOSSIL

## BEIGE



### STONE

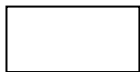

30x60  6  
FOSSIL BEIGE  
**FSN03100** F 38,90



50x50  4  
FOSSIL BEIGE  
**FSN24100** F 38,90



30x30  6  
MOS. QUADRETTI FOSSIL BEIGE  
**FSN03110** F 101,90



30x30  6  
MOS. QUADRETTI FOSSIL MIX CRE/BE/BR.  
**FSN03061** F 101,90



30x30  6  
MOS. MURETTO FOSSIL BEIGE  
**FSN03115** F 106,90

### COORDINATI DA RIVESTIMENTO / WALL COORDINATED DECORS



30x60  6  
BLEND FOSSIL MIX CREAM  
**FSN03500** F 40,90



30x60  2  
ANGOLARE BLEND FOSSIL MIX CREAM  
**FSN03501** PZ 32,90



5x33,3  4  
\* FASCIA ARS HOT  
**FSN03064** PZ 33,90



1,5x30  4  
\* FASCIA VETRO ORO  
**R1R03106** PZ 22,90



1,5x30  4  
\* FASCIA VETRO BRONZO  
**R1R03157** PZ 22,90



30x30  4  
MOS. MINI FOSSIL MIX CRE/BE/BR.  
**FSN03066** PZ 26,90



# FOSSIL

## CREAM



### STONE



30x60  6  
FOSSIL CREAM  
**FSN03050**

F 38,90



50x50  4  
FOSSIL CREAM  
**FSN24050**

F 38,90



30x30  6  
MOS. QUADRETTI FOSSIL CREAM  
**FSN03060**

F 101,90



30x30  6  
MOS. QUADRETTI FOSSIL MIX CRE/BE/BR.  
**FSN03061**

F 101,90



30x30  6  
MOS. MURETTO FOSSIL CREAM  
**FSN03065**

F 106,90

### COORDINATI DA RIVESTIMENTO / WALL COORDINATED DECORS



30x60  6  
BLEND FOSSIL MIX CREAM  
**FSN03500**

F 40,90



30x60  2  
ANGOLARE BLEND FOSSIL MIX CREAM  
**FSN03501**

PZ 32,90



5x33,3  4  
\* FASCIA ARS HOT  
**FSN03064**

PZ 33,90



1,5x30  4  
\* FASCIA VETRO ORO  
**R1R03106**

PZ 22,90



1,5x30  4  
\* FASCIA VETRO BRONZO  
**R1R03157**

PZ 22,90







30x30  4  
MOS. MINI FOSSIL MIX CRE/BE/BR.  
**FSN03066**

PZ 26,90







\* Articoli realizzati in marmo vetro e metalli preziosi; l'utilizzo a pavimento è indicato solo in ambito residenziale.  
Items produced with marble glass and precious metals: the floor use is suitable for residential area only.

# FOSSIL

## PEZZI SPECIALI / SPECIAL TRIMS

		LIGHT GREY	BLUE	BROWN	BEIGE	CREAM
	BATTISCOPA rett. 6,5x80 PZ 8,90  8	<b>FSR51201</b>	<b>FSR51251</b>	<b>FSR51151</b>	<b>FSR51101</b>	-
	BATTISCOPA 8x50 PZ 5,90  12	<b>FSN24201</b>	<b>FSN24251</b>	<b>FSN24151</b>	<b>FSN24101</b>	<b>FSN24051</b>
	GRADINO L rett. 33x40x4 PZ 41,90  1	<b>FSR51205</b>	<b>FSR51255</b>	<b>FSR51155</b>	<b>FSR51105</b>	-

## IMBALLI / PACKAGING

FORMATO NOMINALE NOMINAL SIZE	FORMATO REALE REAL SIZE	 Thickness	 Pcs/Box	 Mq/Box	 Kg/Box	 Box/Pallet	 Mq/Pallet	 Kg/Pallet
40x80 / 16"x32" rett.	40x80	9	3	0,96	19,50	30	28,80	605
20x80 / 8"x32" rett.	19,9x80	9	7	1,12	21,00	42	47,04	1002
30x60 / 12"x24" nat.		9	6	1,08	20,50	40	43,20	840
50x50 / 20"x20" nat.		9	4	1,00	20,00	36	36,00	740

L'unità minima di vendita per tutti gli articoli (fondi, decori e pezzi speciali) è la scatola completa. / The minimum sales quantity for all items (plain tiles, decorations and special trims) is one full box.  
Pezzi speciali e decori per effetto delle lavorazioni, possono presentare variazioni di tonalità. / Due to working process special trims and decors, may show variation in tonality.

## SIGILLANTI COORDINATI PER FUGHE / COORDINATED GROUT SEALANTS

**HARD KOLL**

CODICE SIGILLANTE SEALANT CODE	ABBINAMENTO MATCHING
SI217M kromos grigio luce 0-8	Fossil beige
SI217M kromos grigio luce 0-8	Fossil light grey
SI218B kromos manhattan 0-8	Fossil brown
SI270S kromos avorio 0-8	Fossil cream
SI218B kromos manhattan 0-8	Fossil blue

# GRACE

## GRES PORCELLANATO

PORCELAIN STONEWARE

CLASSIFICAZIONE SECONDO NORME  
UNI EN 14411 (ISO 13006) ALLEGATO G-Gruppo Bla GL  
CLASSIFICATION IN ACCORDANCE  
WITH UNI EN 14411 (ISO 13006) ANNEX G-Group Bla GL

## SUPERFICI E FINITURE

SURFACES AND FINISHES

Lappato rettificato / Honed rectified

## FORMATI

SIZES



60x60



ALABASTRO



MARFIL



PULPIS GRIGIO

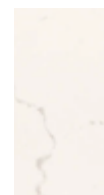

STATUARIO











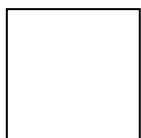

# GRACE

## ALABASTRO

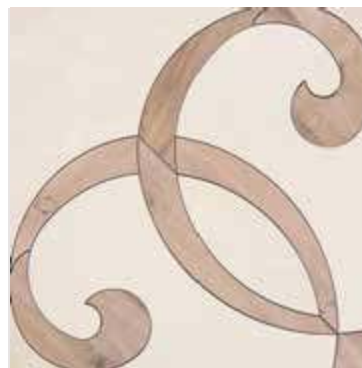

60x60  3  
◆ GRACE ALABASTRO lapp. extra  
**GRL01100** rett. F 64,90



60x60  2  
◆ DEC. INTARSIO ALABASTRO  
**GRL01102** rett. PZ 199,90  
(ALABASTRO - SOLERAS AVANA)

### ◆ LAPPATO EXTRA

È un trattamento protettivo brevettato specifico per superfici ceramiche lappate a campo pieno realizzato con tecnologia e materiali di ultima generazione. Applica una protezione invisibile che lascia inalterate nel tempo le caratteristiche estetiche del prodotto e l'elevato grado di lucentezza. È resistente alle macchie ed allo sporco.

Si pulisce con grande facilità e non richiede particolare manutenzione.

La manutenzione ordinaria deve essere eseguita con prodotti neutri, privi di cere o patine lucidanti, per non togliere al pavimento l'originale lucentezza derivata dal trattamento.

It's a patented protective treatment for specific glossy polished ceramic surfaces realized with the latest technology and materials.

Applies an invisible protection that maintains the aesthetic characteristics of the product and leaves the high glossy effect.

It's stains and dirt resistant.

Easy to clean and requires no special maintenance.

182 The ordinary maintenance must be realized with neutral, wax or polishing glaze free products, in order to preserve the original surface glossiness derived from the treatment.

# GRACE

## MARFIL

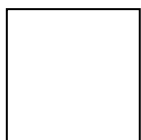

◆ 60x60  3  
◆ GRACE MARFIL lapp. extra  
GRL01250 rett. F 64,90



60x60  2  
◆ DEC. INTARSIO MARFIL  
GRL01252 rett. PZ 199,90  
(MARFIL - SOLERAS AVANA)

### ◆ LAPPATO EXTRA

È un trattamento protettivo brevettato specifico per superfici ceramiche lappate a campo pieno realizzato con tecnologia e materiali di ultima generazione. Applica una protezione invisibile che lascia inalterate nel tempo le caratteristiche estetiche del prodotto e l'elevato grado di lucentezza. È resistente alle macchie ed allo sporco.

Si pulisce con grande facilità e non richiede particolare manutenzione.

La manutenzione ordinaria deve essere eseguita con prodotti neutri, privi di cere o patine lucidanti, per non togliere al pavimento l'originale lucentezza derivata dal trattamento.

It's a patented protective treatment for specific glossy polished ceramic surfaces realized with the latest technology and materials.

Applies an invisible protection that maintains the aesthetic characteristics of the product and leaves the high glossy effect.

It's stains and dirt resistant.

Easy to clean and requires no special maintenance.

The ordinary maintenance must be realized with neutral, wax or polishing glaze free products, in order to preserve the original surface glossiness derived from the treatment.



# GRACE

## PULPIS GRIGIO

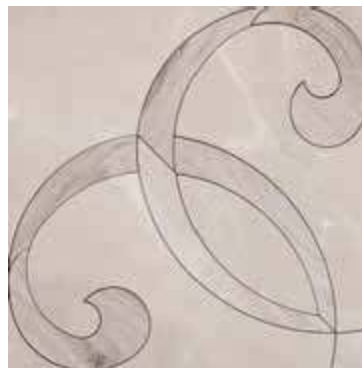

60x60  2  
◆ DEC. INTARSIO PULPIS GRIGIO  
**GRL01202** rett. PZ 199,90

(PULPIS GRIGIO - SOLERAS GRIGIO)

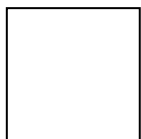

60x60  3  
◆ GRACE PULPIS GRIGIO lapp. extra  
**GRL01200** rett. F 64,90

### ◆ LAPPATO EXTRA

È un trattamento protettivo brevettato specifico per superfici ceramiche lappate a campo pieno realizzato con tecnologia e materiali di ultima generazione.

Applica una protezione invisibile che lascia inalterate nel tempo le caratteristiche estetiche del prodotto e l'elevato grado di lucentezza.

È resistente alle macchie ed allo sporco.

Si pulisce con grande facilità e non richiede particolare manutenzione.

La manutenzione ordinaria deve essere eseguita con prodotti neutri, privi di cere o patine lucidanti, per non togliere al pavimento l'originale lucentezza derivata dal trattamento.

It's a patented protective treatment for specific glossy polished ceramic surfaces realized with the latest technology and materials.

Applies an invisible protection that maintains the aesthetic characteristics of the product and leaves the high glossy effect.

It's stains and dirt resistant.

Easy to clean and requires no special maintenance.

184 The ordinary maintenance must be realized with neutral, wax or polishing glaze free products, in order to preserve the original surface glossiness derived from the treatment.

# GRACE

## STATUARIO

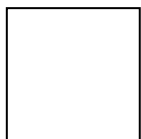

◆ 60x60  3  
◆ GRACE MARFIL lapp. extra  
**GRL01050** rett. F 64,90

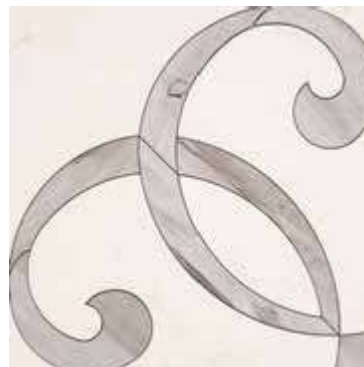

60x60  2  
◆ DEC. INTARSIO STATUARIO  
**GRL01052** rett. PZ 199,90  
(STATUARIO - SOLERAS GRIGIO)

### ◆ LAPPATO EXTRA

È un trattamento protettivo brevettato specifico per superfici ceramiche lappate a campo pieno realizzato con tecnologia e materiali di ultima generazione. Applica una protezione invisibile che lascia inalterate nel tempo le caratteristiche estetiche del prodotto e l'elevato grado di lucentezza. È resistente alle macchie ed allo sporco.

Si pulisce con grande facilità e non richiede particolare manutenzione.

La manutenzione ordinaria deve essere eseguita con prodotti neutri, privi di cere o patine lucidanti, per non togliere al pavimento l'originale lucentezza derivata dal trattamento.

It's a patented protective treatment for specific glossy polished ceramic surfaces realized with the latest technology and materials.

Applies an invisible protection that maintains the aesthetic characteristics of the product and leaves the high glossy effect.

It's stains and dirt resistant.





Easy to clean and requires no special maintenance.

The ordinary maintenance must be realized with neutral, wax or polishing glaze free products, in order to preserve the original surface glossiness derived from the treatment.









# GRACE

## PEZZI SPECIALI / SPECIAL TRIMS

					
		ALABASTRO	MARFIL	PULPIS GRIGIO	STATUARIO
	BATTISCOPA lapp. extra rett. 6,5x60 PZ 8,90 📏 10 ✦	<b>GRL01101</b>	<b>GRL01251</b>	<b>GRL01201</b>	<b>GRL01051</b>

## IMBALLI / PACKAGING

FORMATO NOMINALE NOMINAL SIZE	FORMATO REALE REAL SIZE	 Thickness	 Pcs/Box	 Mq/Box	 Kg/Box	 Box/Pallet	 Mq/Pallet	 Kg/Pallet
60x60 / 24"x24" rett.	59,6x59,6	10	3	1,08	23,00	40	43,20	940

L'unità minima di vendita per tutti gli articoli (fondi, decori e pezzi speciali) è la scatola completa. / The minimum sales quantity for all items (plain tiles, decorations and special trims) is one full box.  
Pezzi speciali e decori per effetto delle lavorazioni, possono presentare variazioni di tonalità. / Due to working process special trims and decors, may show variation in tonality.

## SIGILLANTI COORDINATI PER FUGHE / COORDINATED GROUT SEALANTS

**HARD KOLL**

CODICE SIGILLANTE SEALANT CODE	ABBINAMENTO MATCHING
SI217M kromos grigio luce 0-8	Grace alabastro
S234B kromos bahama beige 0-8	Grace marfil
SI217M kromos grigio luce 0-8	Grace pulpis grigio
SI217M kromos grigio luce 0-8	Grace statuario

# PETRAIA

## GRES PORCELLANATO

PORCELAIN STONEWARE

CLASSIFICAZIONE SECONDO NORME  
UNI EN 14411 (ISO 13006) ALLEGATO G-Gruppo Bla GL  
CLASSIFICATION IN ACCORDANCE  
WITH UNI EN 14411 (ISO 13006) ANNEX G-Group Bla GL

## SUPERFICI E FINITURE

SURFACES AND FINISHES

Naturale / Natural  
Grip

## FORMATI

SIZES



 Monocottura da rivestimento  
Single-fired wall tiles

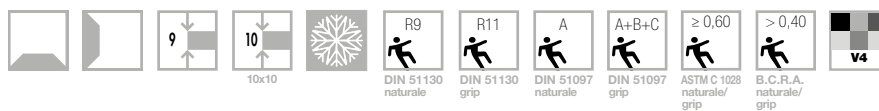



# PETRAIA

ROSSO

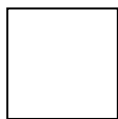

50x50  4  
PETRAIA ROSSO  
-A6117.OA

F 36,90



33,3x33,3  11  
PETRAIA ROSSO

-A8537.H F 31,90  
-A8537.GH grip F 36,90



25x25  18  
PETRAIA ROSSO  
-A5017.0

F 36,90



16,65x33,3  22  
PETRAIA ROSSO TAVELLA DA PRESSA  
-A8537.PC F 36,90  
-A8537.PGC grip F 36,90



16,65x16,65  44  
PETRAIA ROSSO TOZZETTO  
-A8537.8P F 42,90



33,3x33,3  5  
MOS. QUADRETTI ROSSO  
-A8537.U

PZ 16,90



33,3x33,3  5  
MOS. QUADRETTI OCRA/CO./RO.  
-A8525.UM

PZ 16,90



25x35  8  
PARQUET

-A5017.A

PZ 17,90



12,5x25  8  
FRECCIA TRIANGOLI

-A5017.H

PZ 11,90



4x36  10  
RACCORDO PARQUET

-A5017.M

PZ 9,90



12,5x25  8  
FRECCIA RETTANGOLI

-A5017.G

PZ 9,90



12,5x12,5  12  
TOZZETTO ARALDICO (2 SOGG.)

-A5017.B

PZ 17,90



2,5x12,5  20  
Q. ROUND ROSSO

-A5017.11

PZ 6,90



2,5x1  20  
SGUSCIA ROSSO

-A5017.12

PZ 12,90

# PETRAIA

## COTTO

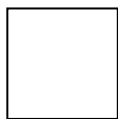

50x50  4  
PETRAIA COTTO  
-A6107.OA

F 36,90



33,3x33,3  11  
PETRAIA COTTO

-A8527.H F 31,90  
-A8527.GH grip F 36,90



25x25  18  
PETRAIA COTTO  
-A500.70

F 36,90



16,65x33,3  22  
PETRAIA COTTO TAVELLA DA PRESSA  
-A8527.PC F 36,90  
-A8527.PGC grip F 36,90



16,65x16,65  44  
PETRAIA COTTO TOZZETTO  
-A8527.8P F 42,90



33,3x33,3  5  
MOS. QUADRETTI COTTO  
-A8527.U PZ 16,90



33,3x33,3  5  
MOS. QUADRETTI OCRA/CO./RO.  
-A8525.UM PZ 16,90



25x35  8  
PARQUET  
-A5007.A PZ 17,90



12,5x25  8  
FRECCIA TRIANGOLI  
-A5017.H PZ 11,90



4x36  10  
RACCORDO PARQUET  
-A5007.M PZ 9,90



12,5x25  8  
FRECCIA RETTANGOLI  
-A50007.G PZ 9,90



12,5x12,5  12  
TOZZETTO ARALDICO (2 SOGG.)  
-A5017.B PZ 17,90



2,5x12,5  20  
Q. ROUND COTTO  
-A5007.11 PZ 6,90



2,5x1  20  
SGUSCIA COTTO  
-A5007.12 PZ 12,90



# PETRAIA

OCRA

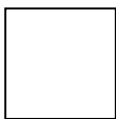

50x50  4  
PETRAIA OCRA  
-A6105.OA

F 36,90



33,3x33,3  11  
PETRAIA OCRA  
-A8525.H  
-A8525.GH grip

F 31,90  
F 36,90



25x25  18  
PETRAIA OCRA  
-A5005.0

F 36,90



16,65x33,3  22  
PETRAIA OCRA TAVELLA DA PRESSA  
-A8525.PC  
-A8525.PGC grip

F 36,90  
F 36,90



16,65x16,65  44  
PETRAIA OCRA TOZZETTO  
-A8525.8P

F 42,90



33,3x33,3  5  
MOS. QUADRETTI OCRA  
-A8525.U

PZ 16,90



33,3x33,3  5  
MOS. QUADRETTI OCRA/CO./RO.  
-A8525.UM

PZ 16,90



25x35  8  
PARQUET  
-A5005.A

PZ 17,90



12,5x25  8  
FRECCIA TRIANGOLI  
-A5017.H

PZ 11,90



4x36  10  
RACCORDO PARQUET  
-A5005.M

PZ 9,90



12,5x25  8  
FRECCIA RETTANGOLI  
-A5005.G

PZ 9,90



12,5x12,5  12  
TOZZETTO ARALDICO (2 SOGG.)  
-A5005.B

PZ 17,90



2,5x12,5  20  
Q. ROUND OCRA  
-A5005.11

PZ 6,90



2,5x1  20  
SGUSCIA OCRA  
-A5005.12

PZ 12,90



5x12,5  12  
V-CAP OCRA  
-A5005.4

PZ 8,90



5x5  20  
C-CAP OCRA  
-A5005.5

PZ 16,90

# PETRAIA

BEIGE

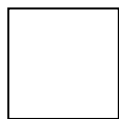

50x50  4  
PETRAIA BEIGE  
-A61000.A

F 36,90



33,3x33,3  11  
PETRAIA BEIGE  
-A8520.H  
-A8520.GH grip

F 31,90  
F 36,90



25x25  18  
PETRAIA BEIGE  
-A5000.0

F 36,90



16,65x33,3  22  
PETRAIA BEIGE TAVELLA DA PRESSA  
-A8520.PC  
-A8520.PGC grip

F 36,90  
F 36,90



16,65x16,65  44  
PETRAIA BEIGE TOZZETTO  
-A8520.8P

F 42,90



33,3x33,3  5  
MOS. QUADRETTI BEIGE  
-A8520.U

PZ 16,90



33,3x33,3  5  
MOS. QUADRETTI BEIGE/NERO  
-A8520.UM

PZ 16,90



25x35  8  
PARQUET  
-A5000.A

PZ 17,90



12,5x25  8  
FRECCIA TRIANGOLI  
-A5000.H

PZ 11,90



4x36  10  
RACCORDO PARQUET  
-A5000.M

PZ 9,90



12,5x25  8  
FRECCIA RETTANGOLI  
-A5000.G

PZ 9,90



12,5x12,5  12  
TOZZETTO ARALDICO (2 SOGG.)  
-A5000.B

PZ 17,90



2,5x12,5  20  
Q. ROUND BEIGE  
-A5006.G

PZ 6,90



2,5x1  20  
SGUSCIA BEIGE  
-A5000.12

PZ 12,90

# PETRAIA

## ALMOND

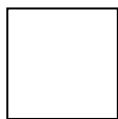

50x50  $\boxtimes$  4  
PETRAIA ALMOND  
-A6104.OA F 36,90



33,3x33,3  $\boxtimes$  11  
PETRAIA ALMOND  
-A8524.H F 31,90



25x25  $\boxtimes$  18  
PETRAIA ALMOND  
-A5004.0 F 36,90



16,65x33,3  $\boxtimes$  22  
PETRAIA ALMOND TAVELLA DA PRESSA  
-A8524.PC F 36,90



33,3x33,3  $\boxtimes$  5  
MOS. QUADRETTI ALMOND  
-A8524.U PZ 16,90



33,3x33,3  $\boxtimes$  5  
MOS. QUADRETTI ALMOND/VERDE  
-A8524.UM PZ 16,90



25x35  $\boxtimes$  8  
PARQUET  
-A5004.A PZ 17,90



12,5x25  $\boxtimes$  8  
FRECCIA TRIANGOLI  
-A5004.H PZ 11,90



4x36  $\boxtimes$  10  
RACCORDO PARQUET  
-A5004.M PZ 9,90



12,5x25  $\boxtimes$  8  
FRECCIA RETTANGOLI  
-A5004.G PZ 9,90



12,5x12,5  $\boxtimes$  12  
TOZZETTO ARALDICO (2 SOGG.)  
-A5004.B PZ 17,90

# PETRAIA

VERDE



33,3x33,3  11  
PETRAIA VERDE  
-A8528.H

F 31,90



25x25  18  
PETRAIA VERDE  
-A5008.0

F 36,90



16,65x33,3  22  
PETRAIA VERDE TAVELLA DA PRESSA  
-A8528.PC

F 36,90



33,3x33,3  5  
MOS. QUADRETTI VERDE  
-A8528.U

PZ 16,90



33,3x33,3  5  
MOS. QUADRETTI VERDE/ALMOND  
-A8524.UM

PZ 16,90



25x35  8  
PARQUET  
-A5008.A

PZ 17,90



12,5x25  8  
FRECCIA TRIANGOLI  
-A5008.H

PZ 11,90



4x36  10  
RACCORDO PARQUET  
-A5008.M

PZ 9,90



12,5x25  8  
FRECCIA RETTANGOLI  
-A5008.G

PZ 9,90



12,5x12,5  12  
TOZZETTO ARALDICO (2 SOGG.)  
-A5008.B

PZ 17,90

# PETRAIA

NERO



33,3x33,3  $\boxtimes$  11  
PETRAIA NERO  
-A8526.H

F 31,90



25x25  $\boxtimes$  18  
PETRAIA NERO  
-A5006.0

F 36,90



16,65x33,3  $\boxtimes$  22  
PETRAIA NERO TAVELLA DA PRESSA  
-A8526.PC

F 36,90



33,3x33,3  $\boxtimes$  5  
MOS. QUADRETTI NERO  
-A8526.U

PZ 16,90



33,3x33,3  $\boxtimes$  5  
MOS. QUADRETTI BEIGE/NERO  
-A8520.UM

PZ 16,90



25x35  $\boxtimes$  8  
PARQUET

-A5006.A

PZ 17,90



4x36  $\boxtimes$  10  
RACCORDO PARQUET

-A5006.M

PZ 9,90



12,5x25  $\boxtimes$  8  
FRECCIA RETTANGOLI

-A5006.G

PZ 9,90



12,5x12,5  $\boxtimes$  12  
TOZZETTO ARALDICO (2 SOGG.)  
-A5006.B

PZ 17,90



Ocra 25x25

COORDINATI DA PAVIMENTO ABBINABILI A PETRAIA OCRA - ROSSO - COTTO. / FLOOR COORDINATED DECORS WHICH MATCH THE OCRA, ROSSO AND COTTO PETRAIA PLAIN TILES.



12,5x25  $\oplus$  12  
LISTELLO DECORATO  
-A5017.V PZ 12,90



12,5x25  $\oplus$  12  
LISTELLO DECORATO  
-A5017.S PZ 12,90



12,5x25  $\oplus$  12  
LISTELLO DECORATO  
-A5017.Q PZ 12,90



12,5x25  $\oplus$  12  
LISTELLO DECORATO  
-A5017.J PZ 12,90



25x25  $\oplus$  12  
INSERTO CHIANTI  
-A5007.F PZ 17,90



12,5x12,5  $\oplus$  12  
TOZZETTO DECORATO  
-A5017.W PZ 9,90



12,5x12,5  $\oplus$  12  
TOZZETTO DECORATO  
-A5017.X PZ 9,90



12,5x12,5  $\oplus$  12  
TOZZETTO DECORATO  
-A5017.P PZ 9,90



12,5x12,5  $\oplus$  12  
TOZZETTO DECORATO  
-A5017.K PZ 9,90

Si consiglia di pulire la superficie senza utilizzare prodotti contenenti sostanze abrasive.  
Do not use products containing abrasive substances to clean the decorative element.



# PETRAIA

MONOCOTTURA DA RIVESTIMENTO  
SINGLE-FIRED WALL TILES



10x10  $\boxtimes$  68  
PETRAIA ROSSO  
-A2017.0 F 40,90



5x20  $\boxtimes$  12  
TORELLO ROSSO  
-A2017.26 PZ 13,90



5x3  $\boxtimes$  12  
ANG. TORELLO ROSSO  
-A2017.27 PZ 13,90



2x20  $\boxtimes$  12  
BOMBATO ROSSO  
-A2017.28 PZ 9,90



2x2  $\boxtimes$  12  
ANG. BOMBATO ROSSO  
-A2017.29 PZ 13,90



10x10  $\boxtimes$  12  
DEC. SOFFIO MIX ROSSO  
-A2017.A PZ 10,90



10x10  $\boxtimes$  12  
DEC. FIORITO MIX ROSSO  
-A2017.C PZ 7,90



5x20  $\boxtimes$  24  
LIST. SOFFIO ROSSO  
-A2017.B PZ 15,90



5x10  $\boxtimes$  12  
LIST. FIORITO MIX ROSSO  
-A2017.D PZ 4,90



10x10  $\boxtimes$  12  
DEC. ULIVETO MIX ROSSO  
-A2017.I PZ 12,90



10x10  68  
 PETRAIA COTTO  
 -A2007.0 F 40,90



5x20  12  
 TORELLO COTTO  
 -A2007.26 PZ 13,90



5x3  12  
 ANG. TORELLO COTTO  
 -A2007.27 PZ 13,90



2x20  12  
 BOMBATO COTTO  
 -A2007.28 PZ 9,90



2x2  12  
 ANG. BOMBATO COTTO  
 -A2007.29 PZ 13,90



10x10  12  
 DEC. SOFFIO MIX COTTO  
 -A2007.A PZ 10,90



10x10  12  
 DEC. FIORITO MIX COTTO  
 -A2007.C PZ 7,90



5x20  24  
 LIST. SOFFIO COTTO  
 -A2007.B PZ 15,90



5x10  12  
 LIST. FIORITO MIX COTTO  
 -A2007.D PZ 4,90



10x10  12  
 DEC. ULIVETO MIX COTTO  
 -A2007.I PZ 12,90



10x10  68  
 PETRAIA OCRA  
 -A2005.0 F 40,90



5x20  12  
 TORELLO OCRA  
 -A2005.26 PZ 13,90



5x3  12  
 ANG. TORELLO OCRA  
 -A2005.27 PZ 13,90



2x20  12  
 BOMBATO OCRA  
 -A2005.28 PZ 9,90



2x2  12  
 ANG. BOMBATO OCRA  
 -A2005.29 PZ 13,90



10x10  12  
 DEC. SOFFIO MIX OCRA  
 -A2005.A PZ 10,90



10x10  12  
 DEC. FIORITO MIX OCRA  
 -A2005.C PZ 7,90



5x20  24  
 LIST. SOFFIO OCRA  
 -A2005.B PZ 15,90



5x10  12  
 LIST. FIORITO MIX OCRA  
 -A2005.D PZ 4,90



10x10  12  
 DEC. ULIVETO MIX OCRA  
 -A2005.I PZ 12,90



10x10  12  
 FORM. FRUCTIS MIX OC/CO/RO.  
 -A2005.M PZ 26,90



3,5x20  12  
 LIST. FRUCTIS OC/CO/RO.  
 -A2005.N PZ 17,90



10x10  12  
 LIST. MAIOLICA MIX ALMOND  
 -A2000.G PZ 17,90



5x20  12  
 LIST. MAIOLICA MIX ALMOND  
 -A2000.H PZ 17,90



# PETRAIA

MONOCOTTURA DA RIVESTIMENTO  
SINGLE-FIRED WALL TILES



10x10  $\square$  68  
PETRAIA BEIGE  
-A2000.0 F 40,90



5x20  $\square$  12  
TORELLO BEIGE  
-A2000.26 PZ 13,90



5x3  $\square$  12  
ANG. TORELLO BEIGE  
-A2000.27 PZ 13,90



2x20  $\square$  12  
BOMBATO BEIGE  
-A2000.28 PZ 9,90



2x2  $\square$  12  
ANG. BOMBATO BEIGE  
-A2000.29 PZ 13,90



10x10  $\square$  12  
DEC. SOFFIO MIX BEIGE  
-A2000.A PZ 10,90



10x10  $\square$  12  
DEC. FIORITO MIX BEIGE  
-A2000.C PZ 7,90



5x20  $\square$  24  
LIST. SOFFIO BEIGE  
-A2000.B PZ 15,90



5x10  $\square$  12  
LIST. FIORITO MIX BEIGE  
-A2000.D PZ 4,90



10x10  $\square$  12  
DEC. ULIVETO MIX BEIGE  
-A2000.I PZ 12,90





10x10 68  
 PETRAIA ALMOND  
 -A2004.0 F 40,90



5x20 12  
 TORELLO ALMOND  
 -A2004.26 PZ 13,90



5x3 12  
 ANG. TORELLO ALMOND  
 -A2004.27 PZ 13,90



2x20 12  
 BOMBATO ALMOND  
 -A2004.28 PZ 9,90



2x2 12  
 ANG. BOMBATO ALMOND  
 -A2004.29 PZ 13,90



10x10 12  
 DEC. SOFFIO MIX ALMOND  
 -A2004.A PZ 10,90



10x10 12  
 DEC. FIORITO MIX ALMOND  
 -A2004.C PZ 7,90



5x20 24  
 LIST. SOFFIO ALMOND  
 -A2004.B PZ 15,90



5x10 12  
 LIST. FIORITO MIX ALMOND  
 -A2004.D PZ 4,90



10x10 12  
 DEC. ULIVETO MIX ALMOND  
 -A2004.I PZ 12,90



10x10 68  
 PETRAIA BIANCO  
 -A2001.0 F 40,90



5x20 12  
 TORELLO BIANCO  
 -A2001.26 PZ 13,90



5x3 12  
 ANG. TORELLO BIANCO  
 -A2001.27 PZ 13,90



2x20 12  
 BOMBATO BIANCO  
 -A2001.28 PZ 9,90



2x2 12  
 ANG. BOMBATO BIANCO  
 -A2001.29 PZ 13,90



10x10 12  
 DEC. SOFFIO MIX BIANCO  
 -A2001.A PZ 10,90



10x10 12  
 DEC. FIORITO MIX BIANCO  
 -A2001.C PZ 7,90



10x10 12  
 DEC. SOFFIO MIX BIANCO  
 -A2001.A PZ 10,90



5x10 12  
 LIST. FIORITO MIX BIANCO  
 -A2001.D PZ 4,90



10x10 12  
 DEC. ULIVETO MIX BIANCO  
 -A2001.I PZ 12,90



10x10 12  
 FORM. FRUCTIS MIX OC/CO/RO.  
 -A2001.M PZ 26,90



3,5x20 12  
 LIST. FRUCTIS BE/BI/AL.  
 -A2001.N PZ 17,90



10x10 12  
 FORM. MAIOLICA MIX ALMOND  
 -A2000.G PZ 17,90



5x20 12  
 LIST. MAIOLICA ALMOND  
 -A2000.H PZ 17,90



10x10 12  
 FORM. MAIOLICA MIX BIANCO  
 -A2001.G PZ 17,90



5x20 12  
 LIST. MAIOLICA BIANCO  
 -A2001.H PZ 17,90

# PETRAIA

MONOCOTTURA DA RIVESTIMENTO  
SINGLE-FIRED WALL TILES



10x10 68  
PETRAIA VERDE  
-A2008.0 PZ 40,90



5x20 12  
TORELLO VERDE  
-A2008.26 PZ 13,90



5x3 12  
ANG. TORELLO VERDE  
-A2008.27 PZ 13,90



2x20 12  
BOMBATO VERDE  
-A2008.28 PZ 9,90



2x2 12  
ANG. BOMBATO VERDE  
-A2008.29 PZ 13,90



10x10 12  
DEC. SOFFIO MIX VERDE  
-A2008.A PZ 10,90



10x10 12  
DEC. FIORITO MIX VERDE  
-A2008.C PZ 7,90



5x20 24  
LIST. SOFFIO VERDE  
-A2008.B PZ 15,90



5x10 12  
LIST. FIORITO MIX VERDE  
-A2008.D PZ 4,90



10x10 12  
DEC. ULIVETO MIX VERDE  
-A2008.I PZ 12,90



10x10 68  
PETRAIA NERO  
-A2006.0 F 40,90



5x20 12  
TORELLO NERO  
-A2006.26 PZ 13,90



5x3 12  
ANG. TORELLO NERO  
-A2006.27 PZ 13,90



2x20 12  
BOMBATO NERO  
-A2006.28 PZ 9,90



2x2 12  
ANG. BOMBATO NERO  
-A2006.29 PZ 13,90



10x10 12  
DEC. SOFFIO MIX NERO  
-A2006.A PZ 10,90



10x10 12  
DEC. FIORITO MIX NERO  
-A2006.C PZ 7,90



5x20 24  
LIST. SOFFIO NERO  
-A2006.B PZ 15,90



5x10 12  
LIST. FIORITO MIX NERO  
-A2006.D PZ 4,90



10x10 12  
DEC. ULIVETO MIX NERO  
-A2006.I PZ 12,90



10x10 12  
FORM. FRUCTIS MIX VERDE/NERO  
-A2008.M PZ 26,90



3,5x20 12  
LIST. FRUCTIS VERDE/NERO  
-A2008.N PZ 17,90

# PETRAIA

COORDINATI PER IL RIVESTIMENTO DI STRUTTURE IN MURATURA / COORDINATED TRIMS FOR BRICKWORK TILING

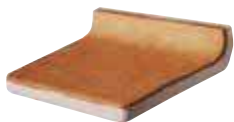

10x10  12  
PETRAIA BATTISTRACCIO PZ 20,90

-A2001.22	BIANCO
-A2004.22	ALMOND
-A2000.22	BEIGE
-A2005.22	OCRA
-A2007.22	COTTO
-A2017.22	ROSSO
-A2008.22	VERDE
-A2006.22	NERO

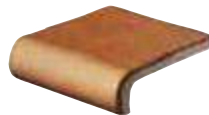

10x10  12  
PETRAIA PIANO LAVORO PZ 20,90

-A2001.18	BIANCO
-A2004.18	ALMOND
-A2000.18	BEIGE
-A2005.18	OCRA
-A2007.18	COTTO
-A2017.18	ROSSO
-A2008.18	VERDE
-A2006.18	NERO



10x10  8  
PETRAIA SPIGOLO PZ 24,90

-A2001.19	BIANCO
-A2004.19	ALMOND
-A2000.19	BEIGE
-A2005.19	OCRA
-A2007.19	COTTO
-A2017.19	ROSSO
-A2008.19	VERDE
-A2006.19	NERO



3x10  12  
PETRAIA Q.ROUND PZ 8,90

-A2001.11	BIANCO
-A2004.11	ALMOND
-A2000.11	BEIGE
-A2005.11	OCRA
-A2007.11	COTTO
-A2017.11	ROSSO
-A2008.11	VERDE
-A2006.11	NERO



3x3  12  
PETRAIA ANG. Q.ROUND PZ 19,90

-A2001.12	BIANCO
-A2004.12	ALMOND
-A2000.12	BEIGE
-A2005.12	OCRA
-A2007.12	COTTO
-A2017.12	ROSSO
-A2008.12	VERDE
-A2006.12	NERO



5x10  12  
PETRAIA V-CAP PZ 9,90

-A2001.4	BIANCO
-A2004.4	ALMOND
-A2000.4	BEIGE
-A2005.4	OCRA
-A2007.4	COTTO
-A2017.4	ROSSO
-A2008.4	VERDE
-A2006.4	NERO



5x3  12  
PETRAIA ANG. V-CAP PZ 22,90

-A2001.5	BIANCO
-A2004.5	ALMOND
-A2000.5	BEIGE
-A2005.5	OCRA
-A2007.5	COTTO
-A2017.5	ROSSO
-A2008.5	VERDE
-A2006.5	NERO





**PETRAIA**

Verde 10x10 - Cotto 10x10

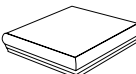

# PETRAIA

## PEZZI SPECIALI / SPECIAL TRIMS

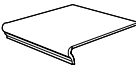
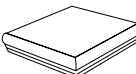
		ROSSO	COTTO	OCRA	BEIGE	ALMOND	VERDE	NERO
	BATTISCOPA 8x33,3 PZ 3,90 ☞ 18	-A8537.6	-A8527.6	-A8525.6	-A8520.6	-A8524.6	-A8528.6	-A8526.6
	BATTISCOPA 7,5x25 PZ 3,90 ☞ 18	-A5017.6	-A5007.6	-A5005.6	-A5000.6	-A5004.6	-A5008.6	-A5006.6
	GRADINO TORELLO 33,3x33,3 PZ 23,90 ☞ 6	-A8537.4	-A8527.4	-A8525.4	-A8520.4	-A8524.4	-A8528.4	-A8526.4
	ANGOLARE TORELLO 33,3x33,3 PZ 42,90 ☞ 2	-A8537.5	-A8527.5	-A8525.5	-A8520.5	-A8524.5	-A8528.5	-A8526.5
	ELEM. L. MONOLITICO 33,3x16,65x5 PZ 17,90 ☞ 8	-A8537.3	-A8527.3	-A8525.3	-A85203.	-	-	-
	ELEM. L. MONOLITICO GRIP 33,3x16,65x5 PZ 17,90 ☞ 8	-A85373.G	-A85273.G	-A85253.G	-A85203.G	-	-	-
	GRAD. MONOLITICO 30x33,3 PZ 35,90 ☞ 6	-A8537.11	-A8527.11	-A8525.11	-	-	-	-
	ANG. MONOLITICO 33,3x33,3 PZ 69,90 ☞ 4	-A8537.12	-A8527.12	-A8525.12	-	-	-	-

## IMBALLI / PACKAGING

FORMATO NOMINALE NOMINAL SIZE	FORMATO REALE REAL SIZE	☞ Thickness	☞ Pcs/Box	☞ Mq/Box	☞ Kg/Box	☞ Box/Pallet	☞ Mq/Pallet	☞ Kg/Pallet
50x50 / 20"x20"	-	9	4	1,00	20,00	36	36,00	740
33,3x33,3 / 13"x13"	-	9	11	1,22	21,50	44	53,68	966
25x25 / 10"x10"	-	9	18	1,13	21,50	54	61,02	1180
16,65x33,3 / 6.5"x13"	-	9	22	1,22	21,50	44	53,68	966
16,65x16,65/ 6.5"x6.5"	-	9	44	1,22	25,00	40	48,80	1020
10x10 / 4"x4"	-	10	68	0,68	13,00	72	48,96	956

L'unità minima di vendita per tutti gli articoli (fondi, decori e pezzi speciali) è la scatola completa. / The minimum sales quantity for all items (plain tiles, decorations and special trims) is one full box. Pezzi speciali e decori per effetto delle lavorazioni, possono presentare variazioni di tonalità. / Due to working process special trims and decors, may show variation in tonality.

## SIGILLANTI COORDINATI PER FUGHE / COORDINATED GROUT SEALANTS

**HARDKOLL**

CODICE SIGILLANTE SEALANT CODE	ABBINAMENTO MATCHING
SI220B kromos antracite 0-8 SI219B kromos grigio cemento 0-8	Petraia rosso - nero - verde
SI234B kromos bahama beige 0-8	Petraia almond - beige
SI219B kromos grigio cemento 0-8	Petraia cotto - ocra

# JERUSALEM

## GRES PORCELLANATO

PORCELAIN STONEWARE

CLASSIFICAZIONE SECONDO NORME  
UNI EN 14411 (ISO 13006) ALLEGATO G-Gruppo B1a GL  
CLASSIFICATION IN ACCORDANCE  
WITH UNI EN 14411 (ISO 13006) ANNEX G-Group B1a GL

## SUPERFICI E FINITURE

SURFACES AND FINISHES

Naturale / Natural

## FORMATI

SIZES

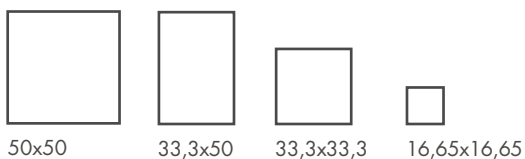

 Monocottura da rivestimento  
Single-fired wall tiles



BEIGE      ALMOND      OCRA







# JERUSALEM

BEIGE

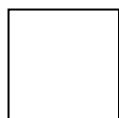

50x50  4  
JERUSALEM BEIGE  
**JE350A** F 36,90



33,3x33,3  11  
JERUSALEM BEIGE  
**JE250C** F 31,90



16,65x16,65  44  
JERUSALEM BEIGE  
**JE750** F 42,90



33,3x33,3  5  
MOSAICO MURETTO BEIGE  
**JE269** PZ 20,90



33,3x33,3  5  
MOS. MURETTO BEIGE/NOCE  
**JE263** PZ 20,90



16x33,3  12  
FASCIA ULIVO OC./ALM./BE.  
**JE406** PZ 23,90



16x16  4  
ANG. FASCIA ULIVO OC./ALM./BE.  
**JE407** PZ 12,90



9,5x33,3  12  
FASCIA CIOTOLI  
**JE110** PZ 25,90



9,5x9,5  4  
ANGOLO CIOTOLI  
**JE111** PZ 18,90



9,5x33,3  12  
FASCIA RIPOSO CIOTOLI  
**JE112** PZ 18,90

# JERUSALEM

## ALMOND

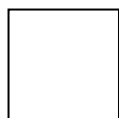

50x50  4  
JERUSALEM ALMOND  
**JE200A** F 36,90



33,3x33,3  11  
JERUSALEM ALMOND  
**JE100C** F 31,90



16,65x16,65  44  
JERUSALEM ALMOND  
**JE700** F 42,90



33,3x33,3  5  
MOSAICO MURETTO ALMOND  
**JE119** PZ 20,90



33,3x33,3  5  
MOS. MURETTO OCRA/ALMOND  
**JE113** PZ 20,90



16x33,3  12  
FASCIA ULIVO OC./ALM./BE.  
**JE406** PZ 23,90



16x16  4  
ANG. FASCIA ULIVO OC./ALM./BE.  
**JE407** PZ 12,90



9,5x33,3  12  
FASCIA CIOTOLI  
**JE110** PZ 25,90



9,5x9,5  4  
ANGOLO CIOTOLI  
**JE111** PZ 18,90



9,5x33,3  12  
FASCIA RIPOSO CIOTOLI  
**JE112** PZ 18,90

# JERUSALEM

OCRA

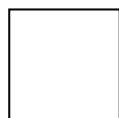

50x50  4  
JERUSALEM OCRA  
**JE500A**

F 36,90

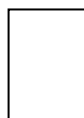

33,3x50  6  
JERUSALEM OCRA  
**JE450**

F 36,90



33,3x33,3  11  
JERUSALEM OCRA  
**JE400C**

F 31,90



16,65x16,65  44  
JERUSALEM OCRA  
**JE800**

F 42,90



33,3x33,3  5  
MOSAICO MURETTO OCRA/ALMOND  
**JE113**

PZ 20,90



16x33,3  12  
FASCIA ULIVO OC./ALM./BE.  
**JE406**

PZ 23,90



16x16  4  
ANG. FASCIA ULIVO OC./ALM./BE.  
**JE407**

PZ 12,90



9,5x33,3  12  
FASCIA CIOTOLI  
**JE110**

PZ 25,90



9,5x9,5  4  
ANGOLO CIOTOLI  
**JE111**

PZ 18,90



9,5x33,3  12  
FASCIA RIPOSO CIOTOLI  
**JE112**

PZ 18,90

# JERUSALEM

MONOCOTTURA DA RIVESTIMENTO  
SINGLE-FIRED WALL TILES



10x10  68  
JERUSALEM ALMOND  
**JE2000** F 40,90



10x10  68  
JERUSALEM BEIGE  
**JE2100** F 40,90



10x10  68  
JERUSALEM OCRA  
**JE2200** F 40,90



10x10  68  
JERUSALEM NOCE  
**JE2300** F 40,90



10x10  12  
FORM. SIMBOLO MIX ALMOND  
**JE2040** PZ 12,90



10x10  12  
FORM. SIMBOLO MIX BEIGE  
**JE2140** PZ 12,90



10x10  12  
FORM. SIMBOLO MIX OCRA  
**JE2240** PZ 12,90



10x10  12  
FORM. SIMBOLO MIX NOCE  
**JE2340** PZ 12,90



5x20  12  
LISTELLO SIMBOLO ALMOND  
**JE2041** PZ 16,90



5x20  12  
LISTELLO SIMBOLO BEIGE  
**JE2141** PZ 16,90



5x20  12  
LISTELLO SIMBOLO OCRA  
**JE2241** PZ 16,90



5x20  12  
LISTELLO SIMBOLO NOCE  
**JE2341** PZ 16,90



3x20  24  
\*TOR. SIMBOLO ALMOND  
**JE2042** PZ 8,90



3x20  24  
\*TOR. SIMBOLO BEIGE  
**JE2142** PZ 8,90



3x20  24  
\*TOR. SIMBOLO OCRA  
**JE2242** PZ 8,90



3x20  24  
\*TOR. SIMBOLO NOCE  
**JE2342** PZ 8,90



3x2  24  
ANG. TORELLO SIMBOLO ALMOND  
**JE2043** PZ 15,90



3x2  24  
ANG. TORELLO SIMBOLO BEIGE  
**JE2143** PZ 15,90



3x2  24  
ANG. TORELLO SIMBOLO OCRA  
**JE2243** PZ 15,90



3x2  24  
ANG. TORELLO SIMBOLO NOCE  
**JE2343** PZ 15,90

\*Lato superiore smaltato. / Glazed upper side.

\*\*Decoro realizzato in marmo. / Marble decorative tile.

# JERUSALEM

MONOCOTTURA DA RIVESTIMENTO  
SINGLE-FIRED WALL TILES



20x30  $\boxtimes$  6  
STRUTTURA UTENSILI BE/OC/NO/RO.  
**JE2152** PZ 109,90



10x10  $\boxtimes$  12  
FORM. UTENSILI MIX BE/OC/NO/RO.  
**JE2150** PZ 28,90



3x20  $\boxtimes$  12  
LIST. UTENSILI BE/OC/NO/RO.  
**JE2151** PZ 16,90



10x0  $\boxtimes$  12  
FORM. RIFUGIO ALM/BE/OC/NO/RO.  
**JE2055** PZ 29,90



2,5x20  $\boxtimes$  12  
LIST. RIFUGIO ALM/BE/OC/NO/RO.  
**JE2056** PZ 15,90



10x10  $\boxtimes$  12  
\*\*DECORO DOMINO ALMOND  
**JE2030** PZ 29,90



5x20  $\boxtimes$  12  
\*\*LISTELLO DOMINO ALMOND  
**JE2031** PZ 29,90

COORDINATI PER IL RIVESTIMENTO DI STRUTTURE IN MURATURA / COORDINATED TRIMS FOR BRICKWORK TILING



10x10  $\boxtimes$  8  
BATTISTRACCIO PZ 20,90

**JE2005** | ALMOND  
**JE2105** | BEIGE  
**JE2205** | OCRA  
**JE2305** | NOCE



10x10  $\boxtimes$  6  
PIANO LAVORO PZ 20,90

**JE2001** | ALMOND  
**JE2101** | BEIGE  
**JE2201** | OCRA  
**JE2301** | NOCE



10x10  $\boxtimes$  2  
SPIGOLO PZ 24,90

**JE2002** | ALMOND  
**JE2102** | BEIGE  
**JE2202** | OCRA  
**JE2302** | NOCE



3x10  $\boxtimes$  6  
Q.ROUND PZ 8,90

**JE2013** | ALMOND  
**JE2113** | BEIGE  
**JE2213** | OCRA  
**JE2313** | NOCE



5x10  $\boxtimes$  6  
VCAP PZ 9,90

**JE2010** | ALMOND  
**JE2110** | BEIGE  
**JE2210** | OCRA  
**JE2310** | NOCE



5x3  $\boxtimes$  4  
ANG. VCAP PZ 22,90







**JE2011** | ALMOND  
**JE2111** | BEIGE  
**JE2211** | OCRA  
**JE2311** | NOCE

# JERUSALEM

## PEZZI SPECIALI / SPECIAL TRIMS

				
		BEIGE	ALMOND	OCRA
	BATTISCOPIA 8x33,3 PZ 3,90  18	JE251	JE101	JE401
	GRADINO 33,3x33,3 PZ 23,90  6	JE252	JE102	JE402
	ANGOLARE 33,3x33,3 PZ 42,90  2	JE253	JE103	JE403

## IMBALLI / PACKAGING

FORMATO NOMINALE NOMINAL SIZE	FORMATO REALE REAL SIZE	 Thickness	 Pcs/Box	 Mq/Box	 Kg/Box	 Box/Pallet	 Mq/Pallet	 Kg/Pallet
50x50 / 20"x20"	-	9	4	1,00	20,00	36	36,00	740
33,3x50 / 13"x20"	-	9	6	1,00	20,40	44	44,00	918
33,3x33,3 / 13"x13"	-	9	11	1,22	24,00	44	53,68	1076
16,65x16,65 / 6.5"x6.5"	-	9	44	1,22	25,00	44	53,68	1020
10x10 / 4"x4"	-	10	68	0,68	13,00	72	48,96	956

L'unità minima di vendita per tutti gli articoli (fondi, decori e pezzi speciali) è la scatola completa. / The minimum sales quantity for all items (plain tiles, decorations and special trims) is one full box. Pezzi speciali e decori per effetto delle lavorazioni, possono presentare variazioni di tonalità. / Due to working process special trims and decors, may show variation in tonality.

## SIGILLANTI COORDINATI PER FUGHE / COORDINATED GROUT SEALANTS

**HARD KOLL**

CODICE SIGILLANTE SEALANT CODE	ABBINAMENTO MATCHING
SI233B kromos jasmin 0-8	Jerusalem beige
SI232B kromos avorio 0-8	Jerusalem almond
SI233B kromos jasmin 0-8	Jerusalem ocra

# ZANZIBAR

## GRES PORCELLANATO

PORCELAIN STONEWARE

CLASSIFICAZIONE SECONDO NORME  
UNI EN 14411 (ISO 13006) ALLEGATO G-Gruppo Bla GL  
CLASSIFICATION IN ACCORDANCE  
WITH UNI EN 14411 (ISO 13006) ANNEX G-Group Bla GL

## SUPERFICI E FINITURE

SURFACES AND FINISHES

Naturale / Natural

## FORMATI

SIZES



50x50



33,3x33,3



SABBIA CHIARO



SABBIA SCURO



GRIGIO CHIARO



GRIGIO SCURO







# ZANZIBAR

## SABBIA CHIARO

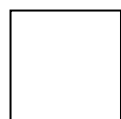

50x50  4  
ZANZIBAR SABBIA CHIARO  
**ZA5000A** F 36,90



33,3x33,3  11  
ZANZIBAR SABBIA CHIARO  
**ZA6000C** F 31,90



33,3x33,3  5  
MOS. QUADRETTI SABBIA CHIARO  
**ZA6010** PZ 16,90



33,3x33,3  6  
MOS. BRICK SABBIA CHIARO  
**ZA6011** PZ 14,90

## SABBIA SCURO

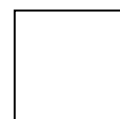

50x50  4  
ZANZIBAR SABBIA SCURO  
**ZA5500A** F 36,90



33,3x33,3  11  
ZANZIBAR SABBIA SCURO  
**ZA6500C** F 31,90



33,3x33,3  5  
MOS. QUADRETTI SABBIA SCURO  
**ZA6510** PZ 16,90



33,3x33,3  6  
MOS. BRICK SABBIA SCURO  
**ZA6511** PZ 14,90



2x33,3  12  
\*FASCIA SENSI SABBIA/OCRA  
**ZA6015** PZ 22,90

\*Coordinato da pavimento realizzato in pietra naturale e alluminio, ogni pezzo é unico e irripetibile.  
Floor coordinated tile made by combining the use of aluminum and natural stone. Every single piece  
turns out to be different and unique.

## GRIGIO CHIARO

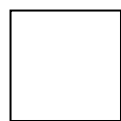

50x50  4  
ZANZIBAR GRIGIO CHIARO  
**ZA5050A** F 36,90



33,3x33,3  11  
ZANZIBAR GRIGIO CHIARO  
**ZA6050C** F 31,90



33,3x33,3  5  
MOS. QUADRETTI GRIGIO CHIARO  
**ZA6060** PZ 16,90



33,3x33,3  6  
MOS. BRICK GRIGIO CHIARO  
**ZA6061** PZ 14,90

## GRIGIO SCURO

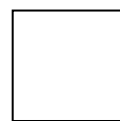

50x50  4  
ZANZIBAR GRIGIO SCURO  
**ZA5550A** F 36,90



33,3x33,3  11  
ZANZIBAR GRIGIO SCURO  
**ZA6550C** F 31,90



33,3x33,3  5  
MOS. QUADRETTI GRIGIO SCURO  
**ZA6560** PZ 16,90



33,3x33,3  6  
MOS. BRICK GRIGIO SCURO  
**ZA6561** PZ 14,90



2x33,3  12  
\*FASCIA SENSI GRIGIA  
**ZA6065** PZ 22,90

\*Coordinato da pavimento realizzato in pietra naturale e alluminio, ogni pezzo é unico e irripetibile.  
Floor coordinated tile made by combining the use of aluminum and natural stone. Every single piece turns out to be different and unique.









# ZANZIBAR

## PEZZI SPECIALI / SPECIAL TRIMS

					
		SABBIA CHIARO	SABBIA SCURO	GRIGIO CHIARO	GRIGIO SCURO
	BATTISCOPA 8x33,3 PZ 3,90  18	<b>ZA6001</b>	<b>ZA6501</b>	<b>ZA6051</b>	<b>ZA6551</b>
	GRADINO TOR. 33,3x33,3 PZ 23,90  6	<b>ZA6002</b>	<b>ZA6502</b>	<b>ZA6052</b>	<b>ZA6552</b>
	ANGOLARE TOR. 33,3x33,3 PZ 42,90  2	<b>ZA6003</b>	<b>ZA6503</b>	<b>ZA6053</b>	<b>ZA6553</b>

## IMBALLI / PACKAGING

FORMATO NOMINALE NOMINAL SIZE	FORMATO REALE REAL SIZE	 Thickness	 Pcs/Box	 Mq/Box	 Kg/Box	 Box/Pallet	 Mq/Pallet	 Kg/Pallet
50x50 / 20"x20"	-	9	4	1,00	20,00	36	36,00	740
33,3x33,3 / 13"x13"	-	9	11	1,22	24,00	44	53,68	1076

L'unità minima di vendita per tutti gli articoli (fondi, decori e pezzi speciali) è la scatola completa. / The minimum sales quantity for all items (plain tiles, decorations and special trims) is one full box. Pezzi speciali e decori per effetto delle lavorazioni, possono presentare variazioni di tonalità. / Due to working process special trims and decors, may show variation in tonality.

## SIGILLANTI COORDINATI PER FUGHE / COORDINATED GROUT SEALANTS

**HARD KOLL**

CODICE SIGILLANTE SEALANT CODE	ABBINAMENTO MATCHING
SI234B kromos bahama beige 0-8	Zanzibar sabbia chiaro
SI234B kromos bahama beige 0-8	Zanzibar sabbia scuro
SI217B kromos grigio luce 0-8	Zanzibar grigio chiaro
SI219B kromos grigio cemento 0-8	Zanzibar grigio scuro

---

20  
15

---

#MY  
ABK

|

RIVESTIMENTI  
CONTEMPORANEI

CONTEMPORARY WALL TILES

---

_____	222	PAPIER
_____	230	SECRET
_____	238	GRACE
_____	252	MARBLEWAY
_____	262	AQUA
_____	268	VISION
_____	274	ATELIER
_____	280	VELVET
_____	284	ZANZIBAR

---

# PAPIER

---

## BICOTTURA IN PASTA BIANCA

DOUBLE-FIRED WHITE BODY TILES

CLASSIFICAZIONE SECONDO NORME  
UNI EN 14411 (ISO 13006) ALLEGATO G-Gruppo BIII GL  
CLASSIFICATION IN ACCORDANCE  
WITH UNI EN 14411 (ISO 13006) ANNEX G-Group BIII GL

---

## FORMATI

SIZES



30x75

---



60x60

Pavimento coordinato in gres porcellanato / Coordinating porcelain floor tiles (pag. 94)

---

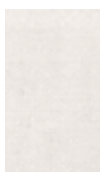

COTONE



CORDA

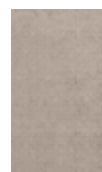

NOCCIOLA



SALVIA

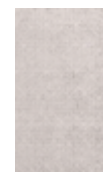

GRIGIO

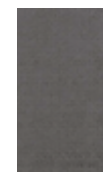

ANTRACITE

---







# PAPIER

Salvia 30x75 - Cotone 30x75 - dec. samarcanda Cotone - dec. samarcanda Salvia - list. samarcanda Topazio





# PAPIER



30x75  5  
PAPIER COTONE  
PPN53050 F 48,90



30x75  5  
PAPIER CORDA  
PPN53100 F 48,90



30x75  5  
PAPIER GRIGIO  
PPN53250 F 48,90



30x75  5  
PAPIER ANTRACITE  
PPN53300 F 48,90



30x75  2  
DEC. SAMARCANDA COTONE  
PPN53057 PZ 52,90



30x75  2  
DEC. SAMARCANDA ANTRACITE  
PPN53307 PZ 52,90

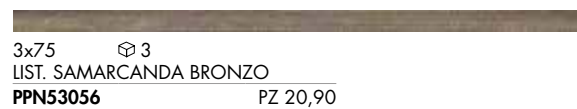

3x75  3  
LIST. SAMARCANDA BRONZO  
PPN53056 PZ 20,90



3x75  3  
LIST. SAMARCANDA BRONZO  
PPN53056 PZ 20,90



30x75  5  
PAPIER NOCCIOLA  
PPN53150 F 48,90



30x75  5  
PAPIER SALVIA  
PPN53200 F 48,90



30x75  2  
DEC. SAMARCANDA SALVIA  
PPN53207 PZ 52,90



3x75  3  
LIST. SAMARCANDA TOPAZIO  
PPN53206 PZ 20,90

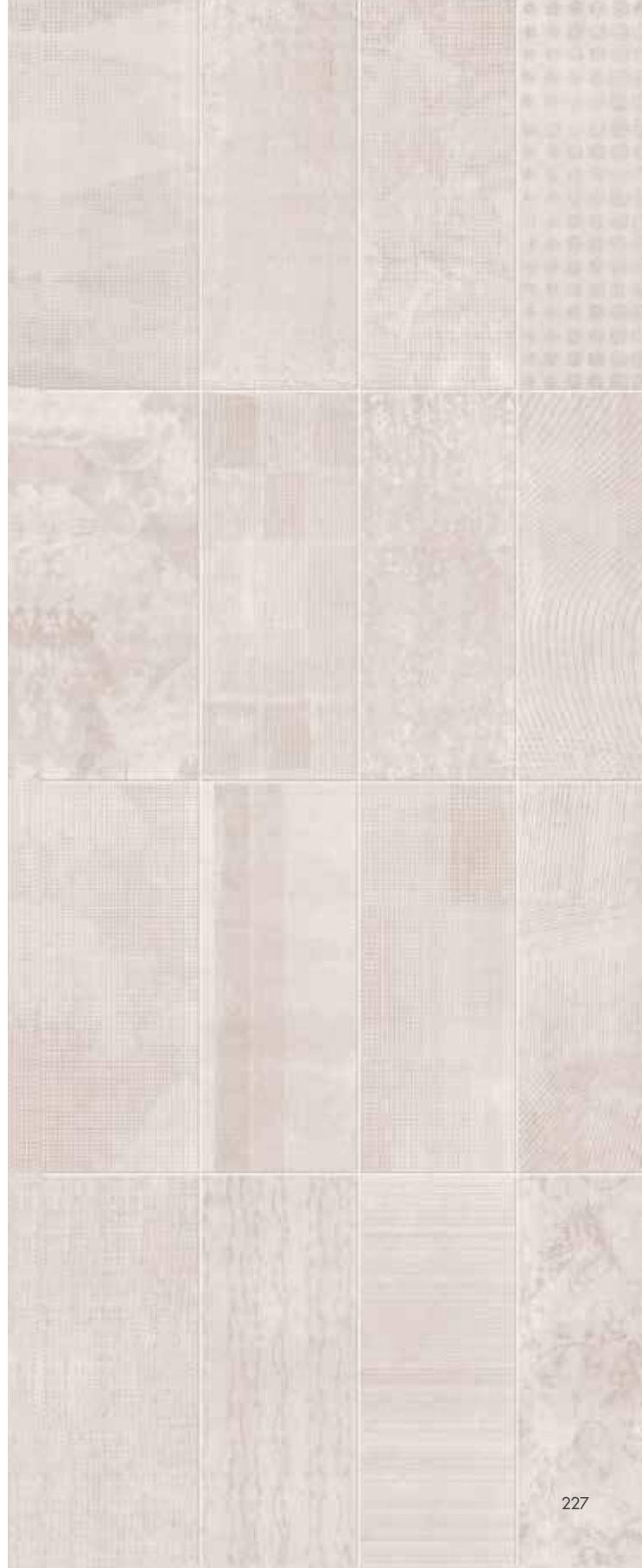

# PAPIER



75x120  1 cp  
COMP. LETTERING CORDA (4 PZ.)  
**PPN53105** PZ 229,90



2,5x30  4  
FASCIA LEGNO PAPIER  
**PPN53058** PZ 12,90

Decorazione realizzata in legno trattato e garantito per l'utilizzo nell'ambiente bagno. Il tipo di verniciatura fa in modo che non tema l'umidità, rendendo possibile la fugatura con normali stucchi ceramici epossidici. Dopo la posa in opera e la stuccatura, pulire il prima possibile con acqua avendo cura di asportare ogni residuo di stucco.

Decorative tile made in treated wood, guaranteed also for use in the bathroom. This kind of varnish protects from humidity, therefore it's possible filling with standard epossidic filler for ceramics. After placing and filling, please clean whitth water as soon as possible, carefully removing every mark left by the filler.

90x225  1 cp = 3 box  
PROGETTO FLEUR CORDA (Comp. 9 pz.)  
**PPN53101** PZ 749,90

PAVIMENTI IN GRES PORCELLANATO / PORCELAIN FLOOR TILES



75x120  1 cp  
 COMP. LETTERING GRIGIO (4 PZ.)  
**PPN53255** PZ 229,90



60x60  3  
 PAPIER GRIGIO  
**PPR01250** rett. F 53,90

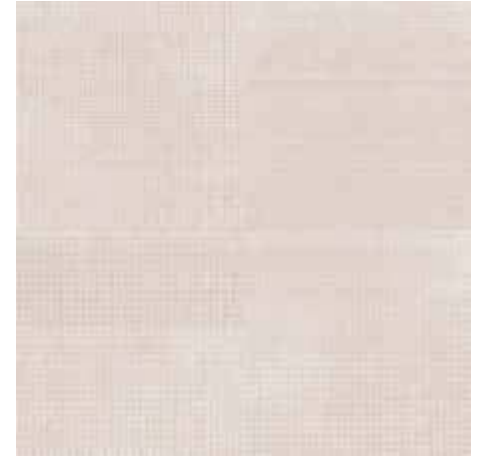

60x60  3  
 PAPIER CORDA  
**PPR01100** rett. F 53,90

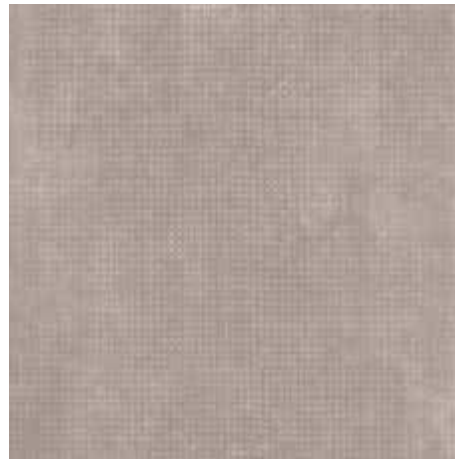







60x60  3  
 PAPIER NOCCIOLA  
**PPR01150** rett. F 53,90



60x60  3  
 PAPIER ANTRACITE  
**PPR01300** rett. F 53,90

Serie completa a pagina 94. / Complete collection page 94.

IMBALLI / PACKAGING

FORMATO NOMINALE NOMINAL SIZE	 Thickness	 Pcs/Box	 Mq/Box	 Kg/Box	 Box/Pallet	 Mq/Pallet	 Kg/Pallet
30x75 / 12"x30"	9	5	1,13	17,60	36	40,68	654
60x60 / 24"x24"	9	3	1,08	21,20	40	43,20	868

L'unità minima di vendita per tutti gli articoli (fondi, decori e pezzi speciali) è la scatola completa. / The minimum sales quantity for all items (plain tiles, decorations and special trims) is one full box.

# SECRET

---

## BICOTTURA IN PASTA BIANCA

DOUBLE-FIRED WHITE BODY TILES

CLASSIFICAZIONE SECONDO NORME  
UNI EN 14411 (ISO 13006) ALLEGATO G-Gruppo BIII GL  
CLASSIFICATION IN ACCORDANCE  
WITH UNI EN 14411 (ISO 13006) ANNEX G-Group BIII GL

---

## FORMATI

SIZES

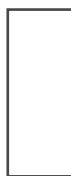

30x75

---



33,3x33,3

Pavimento coordinato in gres porcellanato / Coordinating porcelain floor tiles

---



SOLE



CAPPUCCINO NATURAL



GESSO



TORTORA



NOTTE



MALVA

---











# SECRET



30x75  5  
SECRET GESSO  
**SCT050** F 48,90



30x75  5  
SECRET TORTORA  
**SCT250** F 48,90



3x30  4  
LONDON TORTORA  
**SCT252** PZ 13,90



3x3  2  
ANG. LONDON TORTORA  
**SCT253** PZ 13,90



30x75  5  
SECRET GESSO OPUS  
**SCT051** F 53,90

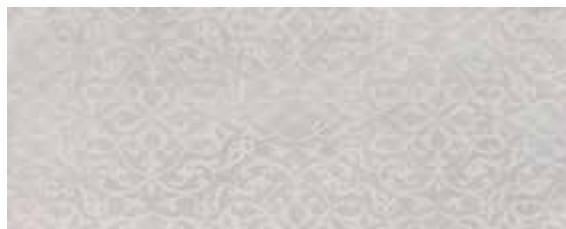

30x75  5  
SECRET TORTORA OPUS  
**SCT251** F 53,90



30x75  2  
DEC. LUXURY PERLA  
**SCT063** PZ 49,90



30x30  4  
MOSAICO MINI GESSO  
**SCT069** PZ 20,90



30x30  4  
MOSAICO MINI TORTORA  
**SCT269** PZ 20,90

Pavimento coordinato in gres porcellanato  
Coordinating porcelain floor tiles



33,3x33,3  11  
SECRET TORTORA  
**SCT2500** F 48,90



30x75  5  
SECRET NATURAL  
**SCT100** F 48,90



3x30  4  
LONDON NATURAL  
**SCT102** PZ 13,90



3x3  2  
ANG. LONDON NATURAL  
**SCT103** PZ 13,90

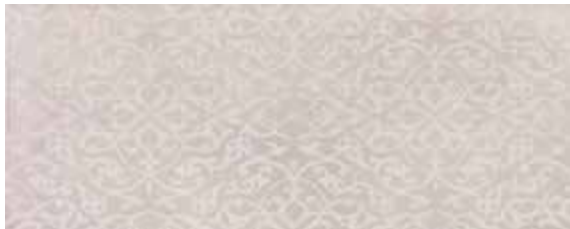

30x75  5  
SECRET NATURAL OPUS  
**SCT101** F 53,90



30x75  2  
DEC. LUXURY BEIGE  
**SCT062** PZ 49,90

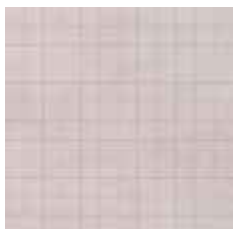

30x30  4  
MOSAICO MINI NATURAL  
**SCT119** PZ 20,90

Pavimento coordinato in gres porcellanato  
Coordinating porcelain floor tiles



33,3x33,3  11  
SECRET NATURAL  
**SCT1000** F 48,90



90x225  1 cp = 3 box  
PROGETTO FEMALE  
**SCT052** PZ 749,90  
(prezzo a cp.)

# SECRET



30x75  5  
SECRET NOTTE  
**SCT300** F 48,90



30x75  5  
SECRET MALVA  
**SCT350** F 48,90



30x75  2  
\*DEC. OPUS NOTTE  
**SCT301** PZ 49,90



30x75  2  
\*DEC. OPUS MALVA  
**SCT351** PZ 49,90



30x75  2  
DEC. REMAKE FLOWER NOTTE  
**SCT055** PZ 54,90



30x75  2  
DEC. REMAKE FLOWER MALVA  
**SCT053** PZ 54,90



30x75  2  
DEC. REMAKE STRIPES NOTTE  
**SCT056** PZ 54,90



30x75  2  
DEC. REMAKE STRIPES MALVA  
**SCT054** PZ 54,90

Pavimento coordinato in gres porcellanato  
Coordinating porcelain floor tiles



33,3x33,3  11  
SECRET NOTTE  
**SCT3000** F 48,90



33,3x33,3  11  
SECRET MALVA  
**SCT3500** F 48,90

\* Articoli realizzati con metalli preziosi; si consiglia di pulire la superficie senza utilizzare prodotti contenenti sostanze abrasive.  
Items produced with precious metals; do not use products containing abrasive substances to clean the surface.



30x75  5  
SECRET CAPPUCCINO  
**SCT200** F 48,90



30x75  5  
SECRET SOLE  
**SCT150** F 48,90

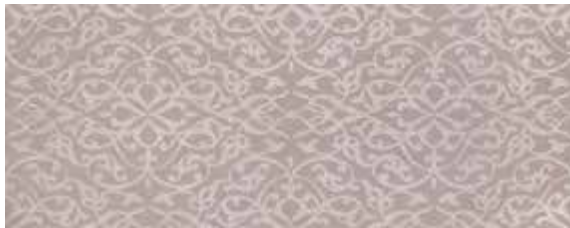

30x75  2  
\* DEC. OPUS CAPPUCCINO  
**SCT201** PZ 49,90



15x75  2  
LIST. ESTATE SOLE MIX 2  
**SCT060** PZ 39,90  
(prezzo cad.)



30x75  3  
DEC. ORIENTE MIX 3  
**SCT061** PZ 54,90  
(prezzo cad.)



2x30  4  
\* FASCIA MICRO ARGENTO  
**SCT067** PZ 13,90







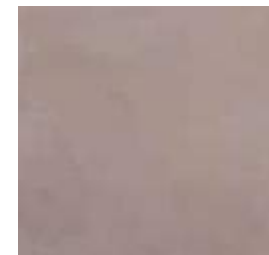

2x30  4  
\* FASCIA MICRO ORO  
**SCT066** PZ 13,90

Pavimento coordinato in gres porcellanato  
Coordinating porcelain floor tiles



33,3x33,3  11  
SECRET CAPPUCCINO  
**SCT2000** F 48,90

#### IMBALLI / PACKAGING

FORMATO NOMINALE NOMINAL SIZE	 Thickness	 Pcs/Box	 Mq/Box	 Kg/Box	 Box/Pallet	 Mq/Pallet	 Kg/Pallet
30x75 / 12"x30"	9	5	1,13	17,60	36	40,68	654
33,3x33,3 / 13"x13"	9	11	1,22	24,00	44	53,68	1076

L'unità minima di vendita per tutti gli articoli (fondi, decori e pezzi speciali) è la scatola completa. / The minimum sales quantity for all items (plain tiles, decorations and special trims) is one full box. 237

# GRACE

---

## BICOTTURA IN PASTA BIANCA

DOUBLE-FIRED WHITE BODY TILES

CLASSIFICAZIONE SECONDO NORME  
UNI EN 14411 (ISO 13006) ALLEGATO G-Gruppo BIII GL  
CLASSIFICATION IN ACCORDANCE  
WITH UNI EN 14411 (ISO 13006) ANNEX G-Group BIII GL

---

## FORMATI

SIZES



30x75



60x60



33,3x33,3

Pavimento coordinato in gres porcellanato / Coordinating porcelain floor tiles (pag. 178)

---

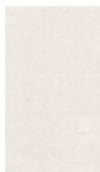

AGATA



STATUARIO

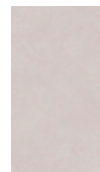

PULPIS GRIGIO



ALABASTRO



MARFIL

---













# GRACE



30x75  5  
GRACE AGATA  
**GRN53150** F 48,90



30x75  5  
GRACE ELEGANCE AGATA  
**GRN53151** F 53,90



30x75  2  
\*DEC. ELEGANCE AGATA  
**GRN53152** PZ 59,90



30x75  2  
\*DEC. HOME LINE AGATA  
**GRN53153** PZ 59,90



30x75  2  
\*DEC. HOME CROSSING  
**GRN53154** PZ 59,90



5x30  4  
LONDON AGATA  
**GRN53157** PZ 15,90  
Lato superiore smaltato  
Glazed upper side



2x30  4  
\*FASCIA MICRO ORO  
**SCT066** PZ 13,90



30x30  4  
MOS. CROSS AGATA  
**GRN53161** F 159,90



30x75  2  
\*DEC. ACANTUS AGATA  
**GRN53155** PZ 59,90



15x75  2  
\*LIST. ACANTUS AGATA  
**GRN53156** PZ 33,90



2x30  4  
MATITA AGATA  
**GRN53158** PZ 9,90

Pavimento coordinato  
in gres porcellanato  
Coordinating porcelain floor tiles



33,3x33,3  11  
GRACE AGATA  
**GRN27150** F 48,90



15x30  4  
BATTISCOPA AGATA  
**GRN53159** PZ 24,90

\* Articoli realizzati con metalli preziosi; si consiglia di pulire la superficie senza utilizzare prodotti contenenti sostanze abrasive.  
Items produced with precious metals; do not use products containing abrasive substances to clean the surface.

# GRACE



30x75  5  
GRACE STATUARIO  
**GRN53050** F 48,90



30x75  5  
THEATRE STATUARIO  
**GRN53300** F 53,90

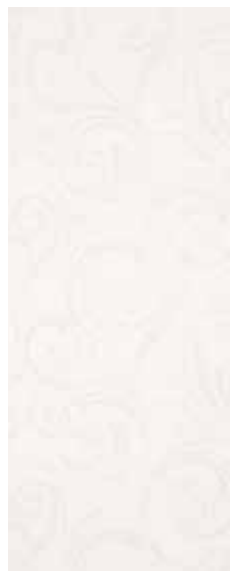

30x75  5  
GRACE ELEGANCE STAT.  
**GRN53051** F 53,90

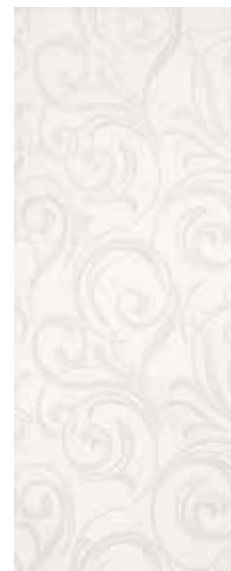

30x75  2  
\*DEC. ELEGANCE STAT.  
**GRN53052** PZ 59,90



5x30  4  
LONDON STATUARIO  
**GRN53057** PZ 15,90  
Lato superiore smaltato  
Glazed upper side



2x30  4  
\*FASCIA MICRO ARGENTO  
**SCT067** PZ 13,90



30x30  4  
MOS. CROSS STATUARIO  
**GRN53061** F 159,90



2x30  4  
MATITTA STATUARIO  
**GRN53058** PZ 9,90



6,5x30  4  
\*LISTELLO VENERE PLATINO  
**GRN53060** PZ 19,90



15x30  4  
BATTISCOPIA STATUARIO  
**GRN53059** PZ 24,90

\* Articoli realizzati con metalli preziosi; si consiglia di pulire la superficie senza utilizzare prodotti contenenti sostanze abrasive.  
Items produced with precious metals; do not use products containing abrasive substances to clean the surface.

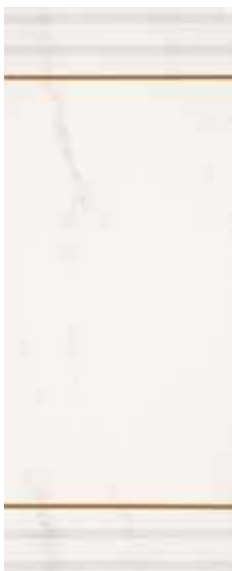

30x75  2  
\* DEC. HOME LINE STAT.  
**GRN53053** PZ 59,90



30x75  2  
\* DEC. HOME CROSSING STAT.  
**GRN53054** PZ 59,90



30x75  2  
\* DEC. ACANTUS STATUARIO  
**GRN53055** PZ 59,90



15x75  2  
\* LIST. ACANTUS STATUARIO  
**GRN53056** PZ 33,90

Pavimento coordinato  
in gres porcellanato  
Coordinating porcelain floor tiles

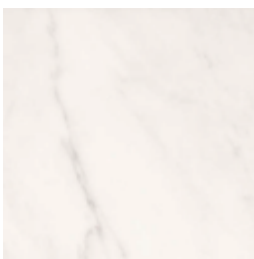

33,3x33,3  11  
GRACE STATUARIO  
**GRN27050** F 48,90

# GRACE



30x75  5  
GRACE PULPIS GRIGIO  
**GRN53200** F 48,90



30x75  5  
THEATRE PULPIS GRIGIO  
**GRN53400** F 53,90



30x75  5  
GRACE ELEGANCE PULPIS GRIGIO  
**GRN53201** F 53,90



30x75  2  
\*DEC. ELEGANCE PULPIS  
**GRN53202** PZ 59,90



5x30  4  
LONDON PULPIS  
**GRN53207** PZ 15,90  
Lato superiore smaltato  
Glazed upper side



2x30  4  
\*FASCIA MICRO ARGENTO  
**SCT067** PZ 13,90



2x30  4  
MATITTA PULPIS  
**GRN53208** PZ 9,90



6,5x30  4  
\*LISTELLO VENERE PLATINO  
**GRN53060** PZ 19,90



30x30  4  
MOS. CROSS PULPIS  
**GRN53211** F 159,90



15x30  4  
BATTISCOPA PULPIS  
**GRN53209** PZ 24,90

\* Articoli realizzati con metalli preziosi; si consiglia di pulire la superficie senza utilizzare prodotti contenenti sostanze abrasive.  
Items produced with precious metals; do not use products containing abrasive substances to clean the surface.



30x75  2  
\* DEC. HOME LINE PULPIS  
**GRN53203** PZ 59,90

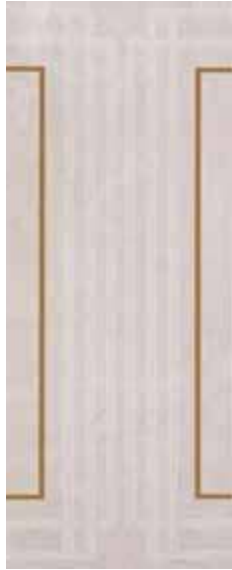

30x75  2  
\* DEC. HOME CROSSING PULPIS  
**GRN53204** PZ 59,90



30x75  2  
\* DEC. ACANTUS PULPIS  
**GRN53205** PZ 59,90



15x75  2  
\* LIST. ACANTUS PULPIS  
**GRN53206** PZ 33,90

Pavimento coordinato  
in gres porcellanato  
Coordinating porcelain floor tiles



33,3x33,3  11  
GRACE PULPIS GRIGIO  
**GRN27200** F 48,90



# GRACE



30x75  5  
GRACE ALABASTRO  
**GRN53100** F 48,90



30x75  5  
THEATRE ALABASTRO  
**GRN53350** F 53,90



30x75  5  
GRACE ELEGANCE ALABASTRO  
**GRN53101** F 53,90



30x75  2  
\*DEC. ELEGANCE ALABASTRO  
**GRN53102** PZ 59,90



5x30  4  
LONDON ALABASTRO  
**GRN53107** PZ 15,90  
Lato superiore smaltato  
Glazed upper side



2x30  4  
\*FASCIA MICRO ORO  
**SCT066** PZ 13,90



2x30  4  
MATITTA ALABASTRO  
**GRN53108** PZ 9,90



6,5x30  4  
\*LISTELLO VENERE ORO  
**GRN53110** PZ 19,90



30x30  4  
MOS. CROSS ALABASTRO  
**GRN53111** F 159,90



15x30  4  
BATTISCOPIA ALABASTRO  
**GRN53109** PZ 24,90

\* Articoli realizzati con metalli preziosi; si consiglia di pulire la superficie senza utilizzare prodotti contenenti sostanze abrasive.  
Items produced with precious metals; do not use products containing abrasive substances to clean the surface.



30x75  2  
\* DEC. HOME LINE ALABASTRO  
**GRN53103** PZ 59,90



30x75  2  
\* DEC. HOME CROSSING ALAB.  
**GRN53104** PZ 59,90



30x75  2  
\* DEC. ACANTUS ALABASTRO  
**GRN53105** PZ 59,90



15x75  2  
\* LIST. ACANTUS ALABASTRO  
**GRN53106** PZ 33,90

Pavimento coordinato  
in gres porcellanato  
Coordinating porcelain floor tiles



33,3x33,3  11  
GRACE ALABASTRO  
**GRN27100** F 48,90

# GRACE



30x75  5  
GRACE MARFIL  
GRN53250 F 48,90



30x75  5  
THEATRE MARFIL  
GRN53450 F 53,90



30x75  5  
GRACE ELEGANCE MARFIL  
GRN53251 F 53,90



30x75  2  
\*DEC. ELEGANCE MARFIL  
GRN53252 PZ 59,90



5x30  4  
LONDON MARFIL  
GRN53257 PZ 15,90  
Lato superiore smaltato  
Glazed upper side



2x30  4  
\*FASCIA MICRO ORO  
SCT066 PZ 13,90



30x30  4  
MOS. CROSS MARFIL  
GRN53261 F 159,90



2x30  4  
MATITA MARFIL  
GRN53258 PZ 9,90



6,5x30  4  
\*LISTELLO VENERE ORO  
GRN53110 PZ 19,90



15x30  4  
BATTISCOPIA MARFIL  
GRN53259 PZ 24,90

\* Articoli realizzati con metalli preziosi; si consiglia di pulire la superficie senza utilizzare prodotti contenenti sostanze abrasive.  
Items produced with precious metals; do not use products containing abrasive substances to clean the surface.



30x75  2  
 \* DEC. HOME LINE MARFIL  
**GRN53253** PZ 59,90



30x75  2  
 \* DEC. HOME CROSSING MARFIL  
**GRN53254** PZ 59,90



30x75  2  
 \* DEC. ACANTUS MARFIL  
**GRN53255** PZ 59,90









15x75  2  
 \* LIST. ACANTUS MARFIL  
**GRN53256** PZ 33,90

Pavimento coordinato  
 in gres porcellanato  
 Coordinating porcelain floor tiles



33,3x33,3  11  
 GRACE MARFIL  
**GRN27250** F 48,90

#### IMBALLI / PACKAGING

FORMATO NOMINALE NOMINAL SIZE	 Thickness	 Pcs/Box	 Mq/Box	 Kg/Box	 Box/Pallet	 Mq/Pallet	 Kg/Pallet
30x75 / 12"x30"	9	5	1,13	17,60	36	40,68	654
33,3x33,3 / 13"x13"	9	11	1,22	24,00	40	53,68	1076

L'unità minima di vendita per tutti gli articoli (fondi, decori e pezzi speciali) è la scatola completa. / The minimum sales quantity for all items (plain tiles, decorations and special trims) is one full box. 251

# MARBLEWAY

---

## BICOTTURA IN PASTA BIANCA

DOUBLE-FIRED WHITE BODY TILES

CLASSIFICAZIONE SECONDO NORME  
UNI EN 14411 (ISO 13006) ALLEGATO G-Gruppo BIII GL  
CLASSIFICATION IN ACCORDANCE  
WITH UNI EN 14411 (ISO 13006) ANNEX G-Group BIII GL

---

## FORMATI

SIZES



33,3x60

---



33,3x33,3

---



ALABASTRO

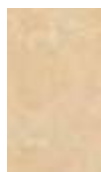

MARFIL



CALACATTA



TRAVERTINO  
BEIGE



LASA



TRAVERTINO  
GRIGIO

---











# MARBLEWAY



33,3x60  8  
MARBLEWAY ALABASTRO  
**MWN43050** F 42,90



33,3x60  4  
DEC. ALABASTRO RIGATO  
**MWN43051** PZ 10,90



4,5x60  4  
LIST. DIAMANTE AMBRA  
**MWN43055** PZ 21,90



33,3x60  4  
DEC. CANNETÉ ALABASTRO  
**MWC43052** PZ 10,90



\*1,1x60  4  
MATITA CANNETÉ ORO  
**MWC43053** PZ 17,90



3,5x33,3  4  
\*LIST. TEXTURE ORO  
**MWN43065** PZ 16,90



10x33,3  4  
BORDURA ALABASTRO  
**MWN43064** PZ 6,90



8x33,3  10  
BULLNOSE ALABASTRO  
**MWN43068** PZ 3,90



33,3x60  2  
\*DEC. ALABASTRO ORO  
**MWN43057** PZ 62,90



5x60  4  
\*LIST. ALABASTRO ORO  
**MWN43067** PZ 28,90



33,3x33,3  11  
MARBLEWAY ALABASTRO  
**MWN2705C** F 42,90



33,3x33,3  5  
MOS. QUADRETTI ALABASTRO  
**MWR27051** F 101,90  
(prezzo al mq.)

Pavimento coordinato in gres porcellanato  
Coordinating porcelain floor tiles

Si consiglia di posare il rivestimento Marbleway a giunto unito The installation of Marbleway wall tile with close joint is recommended

\* Si consiglia di pulire la superficie senza utilizzare prodotti contenenti sostanze abrasive per non alterare la brillantezza del metallo prezioso.

Do not use products containing abrasive substances to clean the decorative element so as not to affect the shine of precious metal.

\*\*Lato superiore smaltato. / Glazed upper side.



33,3x60 8  
MARBLEWAY MARFIL  
**MWN43100** F 42,90



33,3x60 4  
DEC. MARFIL RIGATO  
**MWN43101** PZ 10,90



4,5x60 4  
LIST. DIAMANTE AMBRA  
**MWN43055** PZ 21,90



33,3x60 4  
DEC. CANNETÉ MARFIL  
**MWC43102** PZ 10,90



1,1x60 4  
\*MATITA CANNETÉ ORO  
**MWC43053** PZ 17,90



3,5x33,3 4  
\*LIST. TEXTURE ORO  
**MWN43065** PZ 16,90



10x33,3 4  
BORDURA MARFIL  
**MWN43114** PZ 6,90



8x33,3 10  
BULLNOSE MARFIL  
**MWN43118** PZ 3,90



33,3x60 2  
\*DEC. MARFIL ORO  
**MWN43107** PZ 62,90



5x60 4  
\*LIST. MARFIL ORO  
**MWN43117** PZ 28,90



33,3x33,3 11  
MARBLEWAY MARFIL  
**MWN2710C** F 42,90



33,3x33,3 5  
MOS. QUADRETTI MARFIL  
**MWR27101** F 101,90  
(prezzo al mq.)

Pavimento coordinato in gres porcellanato  
Coordinating porcelain floor tiles

# MARBLEWAY



33,3x60  8  
MARBLEWAY CALACATTA  
**MWN43150** F 42,90



33,3x60  4  
DEC. CALACATTA RIGATO  
**MWN43151** PZ 10,90



4,5x60  4  
LIST. DIAMANTE CORDA  
**MWN43155** PZ 21,90



33,3x60  4  
DEC. CANNETÉ CALACATTA  
**MWC43152** PZ 10,90



1,1x60  4  
\*MATITA CANNETÉ ORO  
**MWC43053** PZ 17,90



3,5x33,3  4  
\*LIST. TEXTURE ORO  
**MWN43065** PZ 16,90



10x33,3  4  
BORDURA CALACATTA  
**MWN43164** PZ 6,90



8x33,3  10  
BULLNOSE CALACATTA  
**MWN43168** PZ 3,90



33,3x60  2  
\*DEC. CALACATTA ORO  
**MWN43157** PZ 62,90



5x60  4  
\*LIST. CALACATTA ORO  
**MWN43167** PZ 28,90



33,3x33,3  11  
MARBLEWAY CALACATTA  
**MWN2715C** F 42,90



33,3x33,3  5  
MOS. QUADRETTI CALACATTA  
**MWR27151** F 101,90  
(prezzo al mq.)

Pavimento coordinato in gres porcellanato  
Coordinating porcelain floor tiles

Si consiglia di posare il rivestimento Marbleway a giunto unito The installation of Marbleway wall tile with close joint is recommended

\* Si consiglia di pulire la superficie senza utilizzare prodotti contenenti sostanze abrasive per non alterare la brillantezza del metallo prezioso.

Do not use products containing abrasive substances to clean the decorative element so as not to affect the shine of precious metal.  
\*\*Lato superiore smaltato. / Glazed upper side.



33,3x60  8  
MARBLEWAY TRAVERTINO BE.  
**MWN43200** F 42,90



33,3x60  4  
DEC. TRAV. BEIGE RIGATO  
**MWN43201** PZ 10,90



4,5x60  4  
LIST. DIAMANTE CORDA  
**MWN43155** PZ 21,90



33,3x60  4  
DEC. CANNETÉ TRAV. BEIGE  
**MWC43202** PZ 10,90



1,1x60  4  
\*MATITA CANNETÉ ORO  
**MWC43053** PZ 17,90



3,5x33,3  4  
\*LIST. TEXTURE ORO  
**MWN43065** PZ 16,90



10x33,3  4  
BORDURA TRAV. BEIGE  
**MWN43214** PZ 6,90



8x33,3  10  
BULLNOSE TRAV. BEIGE  
**MWN43218** PZ 3,90



33,3x60  2  
\*DEC. TRAV. BEIGE ORO  
**MWN43207** PZ 62,90



5x60  4  
\*LIST. TRAV. BEIGE ORO  
**MWN43217** PZ 28,90



33,3x33,3  11  
MARBLEWAY TRAV. BEIGE  
**MWN2720C** F 42,90



33,3x33,3  5  
MOS. QUADRETTI TRAV. BEIGE  
**MWR27201** F 101,90  
(prezzo al mq.)

Pavimento coordinato in gres porcellanato  
Coordinating porcelain floor tiles

# MARBLEWAY



33,3x60  8  
MARBLEWAY LASA  
**MWN43250** F 42,90



33,3x60  4  
DEC. LASA RIGATO  
**MWN43251** PZ 10,90



4,5x60  4  
LIST. DIAMANTE NUVOLA  
**MWN43255** PZ 21,90



33,3x60  4  
DEC. CANNETÉ LASA  
**MWC43252** PZ 10,90



1,1x60  4  
\*MATITA CANNETÉ PLATINO  
**MWC43253** PZ 17,90



3,5x33,3  4  
\*LIST. TEXTURE PLATINO  
**MWN43265** PZ 16,90



10x33,3  4  
BORDURA LASA  
**MWN43264** PZ 6,90



8x33,3  10  
BULLNOSE LASA  
**MWN43268** PZ 3,90



33,3x60  2  
\*DEC. LASA PLATINO  
**MWN43257** PZ 62,90



5x60  4  
\*LIST. LASA PLATINO  
**MWN43267** PZ 28,90



33,3x33,3  11  
MARBLEWAY LASA  
**MWN2725C** F 42,90



33,3x33,3  5  
MOS. QUADRETTI LASA  
**MWR27251** F 101,90  
(prezzo al mq.)

Pavimento coordinato in gres porcellanato  
Coordinating porcelain floor tiles

Si consiglia di posare il rivestimento Marbleway a giunto unito The installation of Marbleway wall tile with close joint is recommended

\* Si consiglia di pulire la superficie senza utilizzare prodotti contenenti sostanze abrasive per non alterare la brillantezza del metallo prezioso.

Do not use products containing abrasive substances to clean the decorative element so as not to affect the shine of precious metal.

\*\*Lato superiore smaltato. / Glazed upper side.



33,3x60 8  
MARBLEWAY TRAV. GRIGIO  
**MWN43300** F 42,90



4,5x60 4  
LIST. DIAMANTE NUVOLE  
**MWN43255** PZ 21,90



33,3x60 4  
DEC. CANNETÉ TRAV. GRIGIO  
**MWC43302** PZ 10,90



1,1x60 4  
\*MATITA CANNETÉ PLATINO  
**MWC43253** PZ 17,90



3,5x33,3 4  
\*LIST. TEXTURE PLATINO  
**MWN43265** PZ 16,90



10x33,3 4  
BORDURA TRAV. GRIGIO  
**MWN43314** PZ 6,90



8x33,3 10  
BULLNOSE TRAV. GRIGIO  
**MWN43318** PZ 3,90



33,3x60 2  
\*DEC. TRAV. GRIGIO PLATINO  
**MWN43307** PZ 62,90



5x60 4  
\*LIST. TRAV. GRIGIO PLATINO  
**MWN43317** PZ 28,90



33,3x33,3 11  
MARBLEWAY TRAV. GRIGIO  
**MWN2730C** F 42,90

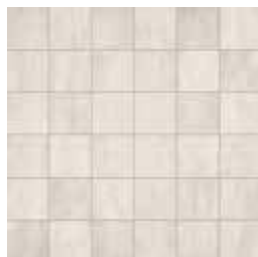

33,3x33,3 5  
MOS. QUADRETTI TRAV. GRIGIO  
**MWR27301** F 101,90  
(prezzo al mq.)

Pavimento coordinato in gres porcellanato  
Coordinating porcelain floor tiles

FORMATO NOMINALE NOMINAL SIZE	Thickness	Pcs/Box	Mq/Box	Kg/Box	Box/Pallet	Mq/Pallet	Kg/Pallet
33,3x60 / 13"x24"	9	8	1,60	24,80	36	57,60	913
33,3x33,3 / 13"x13"	9	11	1,22	24,00	44	53,68	1076

L'unità minima di vendita per tutti gli articoli (fondi, decori e pezzi speciali) è la scatola completa. / The minimum sales quantity for all items (plain tiles, decorations and special trims) is one full box. 261

# AQUA

## BICOTTURA IN PASTA BIANCA

DOUBLE-FIRED WHITE BODY TILES

CLASSIFICAZIONE SECONDO NORME  
UNI EN 14411 (ISO 13006) ALLEGATO G-Gruppo BIII GL  
CLASSIFICATION IN ACCORDANCE  
WITH UNI EN 14411 (ISO 13006) ANNEX G-Group BIII GL

## FORMATI

SIZES



20x60



33,3x33,3

Pavimento coordinato in gres porcellanato / Coordinating porcelain floor tiles

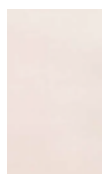

MAGNOLIA  
CHIARO



CIPRIA  
MEDIO



AMETISTA  
SCURO

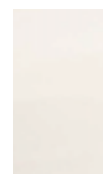

CENERE  
CHIARO



TORTORA  
MEDIO



OLTREMARE  
SCURO



AVORIO  
CHIARO



CANNELLA  
MEDIO



VISONE  
SCURO







**AQUA**

Avorio chiaro 20x60 - Dec. Mare Avorio - CABANE Corda rett.20x80 - 13,5x80





20x60 13  
AQUA AVORIO CHIARO  
**AQ350** F 42,90



20x60 13  
AQUA CANNELLA MEDIO  
**AQ400** F 42,90



20x60 13  
AQUA VISSONE SCURO  
**AQ450** F 42,90



30x30 4  
\*\*MOS. MIX AVO/CANN/VISSONE  
**AQ360** PZ 20,90



20x60 13  
\*DEC. MARE AVORIO  
**AQ351** PZ 5,90



3,5x20 6  
\*\*LONDON CANNELLA MEDIO  
**AQ401** PZ 10,90



3,5x3 6  
ANG. LONDON CANNELLA MEDIO  
**AQ402** PZ 10,90



20x60 2  
\*DEC. PRIMAVERA MIX 2 AVORIO  
**AQ352** (cad.) PZ 49,90



2x60 4  
MATITA PRIMAVERA VISSONE  
**AQ451** PZ 19,90

Pavimento coordinato in gres porcellanato / Coordinating porcelain floor tiles



33,3x33,3 11  
AQUA PAV. CANNELLA MEDIO  
**AQ4000** F 42,90

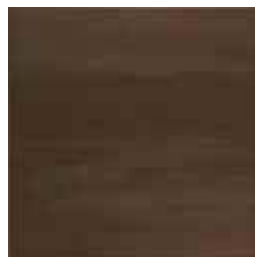

33,3x33,3 11  
AQUA PAV. VISSONE SCURO  
**AQ4500** F 42,90

\* Articoli soggetti a stonalizzazione. / Colour - Shaded Tiles.

\*\* Mosaico senza rete. Le singole tessere sono tenute insieme da una pellicola trasparente adesiva applicata in superficie, che contribuisce a dare maggiore regolarità alle fughe durante le operazioni di posa su supporti ondulati. Si consiglia di rimuovere l'adesivo solo quando i collanti avranno fatto presa e di procedere con la normale stuccatura.  
The mosaic are not mesh-mounted. The individual tiles are held together by a transparent adhesive film applied to the surface, which helps to give greater regularity to the joints in case of an undulated installation. We recommend to remove the adhesive film only when the grout is dry, and then to proceed with the joint filling.

\*\* Lato superiore smaltato. / Glazed upper side.



20x60  13  
AQUA MAGNOLIA CHIARO  
**AQ050** F 42,90



20x60  13  
AQUA CIPRIA MEDIO  
**AQ100** F 42,90



20x60  13  
AQUA AMETISTA SCURO  
**AQ150** F 42,90



30x30  4  
\*\*MOS. MIX MAGN/CIPR/AMET.  
**AQ060** PZ 20,90



20x60  2  
\*DEC. POESIA MIX 2 MAGNOLIA  
**AQ053** (cad.) PZ 49,90



20x60  13  
\*DEC. PREZIOSO MAGNOLIA  
**AQ051** PZ 5,90



3x60  4  
LIST. PERLE AMETISTA  
**AQ151** PZ 25,90



2x60  4  
LIST. POESIA CIPRIA  
**AQ101** PZ 19,90

Pavimento coordinato in gres porcellanato / Coordinating porcelain floor tiles



33,3x33,3  11  
AQUA PAV. CIPRIA MEDIO  
**AQ1000** F 42,90



33,3x33,3  11  
AQUA PAV. AMETISTA SCURO  
**AQ1500** F 42,90

\* Articoli soggetti a stonizzazione. / Colour - Shaded Tiles.

\*\* Mosaico senza rete. Le singole tessere sono tenute insieme da una pellicola trasparente adesiva applicata in superficie, che contribuisce a dare maggiore regolarità alle fughe durante le operazioni di posa su supporti ondulati. Si consiglia di rimuovere l'adesivo solo quando i collanti avranno fatto presa e di procedere con la normale stuccatura. The mosaic are not mesh-mounted. The individual tiles are held together by a transparent adhesive film applied to the surface, which helps to give greater regularity to the joints in case of an undulated installation. We recommend to remove the adhesive film only when the grout is dry, and then to proceed with the joint filling.

\*\* Lato superiore smaltato. / Glazed upper side.



20x60  13  
AQUA CENERE CHIARO  
**AQ200** F 42,90



20x60  13  
AQUA TORTORA MEDIO  
**AQ250** F 42,90



20x60  13  
AQUA OLTREMARE SCURO  
**AQ300** F 42,90

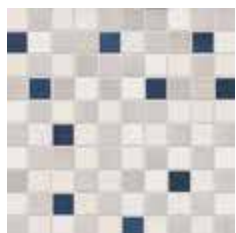

30x30  4  
\*\*MOS. MIX CEN/TORT/OLTREM.  
**AQ210** PZ 20,90



20x60  2  
\*DEC. FANTASIA MIX 2 CENERE  
**AQ203** (cad.) PZ 49,90



3x60  4  
LIST. ONDE OLTREMARE  
**AQ302** PZ 25,90



1x60  4  
MATITA OLTREMARE  
**AQ301** PZ 19,90

Pavimento coordinato in gres porcellanato / Coordinating porcelain floor tiles









33,3x33,3  11  
AQUA PAV. TORTORA MEDIO  
**AQ2500** F 42,90



33,3x33,3  11  
AQUA PAV. OLTREMARE SCURO  
**AQ3000** F 42,90

## IMBALLI / PACKAGING

FORMATO NOMINALE NOMINAL SIZE	 Thickness	 Pcs/Box	 Mq/Box	 Kg/Box	 Box/Pallet	 Mq/Pallet	 Kg/Pallet
20x60 / 8"x24"	9	13	1,56	26,56	44	68,64	1189
33,3x33,3 / 13"x13"	9	11	1,22	24,00	44	53,68	1076

L'unità minima di vendita per tutti gli articoli (fondi, decori e pezzi speciali) è la scatola completa. / The minimum sales quantity for all items (plain tiles, decorations and special trims) is one full box. 267

# VISION

## BICOTTURA IN PASTA BIANCA

DOUBLE-FIRED WHITE BODY TILES

CLASSIFICAZIONE SECONDO NORME  
UNI EN 14411 (ISO 13006) ALLEGATO G-Gruppo BIII GL  
CLASSIFICATION IN ACCORDANCE  
WITH UNI EN 14411 (ISO 13006) ANNEX G-Group BIII GL

## FORMATI

SIZES



20x60

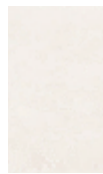

WHITE LUX

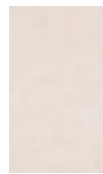

SAND LUX



ANTIQUE  
PINK LUX



SMOKE LUX

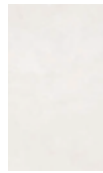

WHITE SAT.

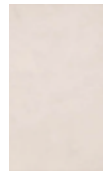

SAND SAT.

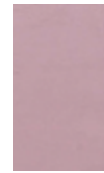

LADY SAT.

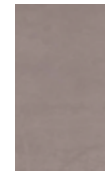

SMOKE SAT.

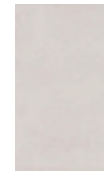

SILVER SAT.





# VISION



20x60  13  
VISION WHITE LUX  
**VIN20500** F 42,90



20x60  13  
VISION GRAPH WHITE/SAND LUX  
**VIN20501** F 46,90



2x60  4  
LISTELLO GRAPH SAND LUX  
**VIN20502** PZ 12,90

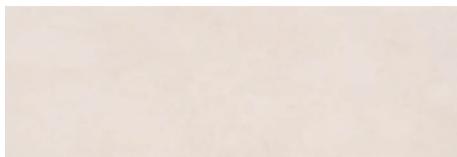

20x60  13  
VISION SAND LUX  
**VIN20600** F 42,90



20x60  13  
VISION MOS. RETTANGOLI SAND LUX  
**VIN20601** F 46,90



2x60  4  
LIST. RETTANGOLI SAND LUX  
**VIN20602** PZ 12,90



20x60  13  
VISION ANTIQUE PINK LUX  
**VIN20650** F 42,90



20x60  13  
VISION SMOKE LUX  
**VIN20550** F 42,90



20x60  2  
DEC. LOVE LUX MIX 2  
**VIN20504** PZ 29,90



20x60  2  
DEC. DESIRE LUX MIX 2  
**VIN20503** PZ 29,90



20x60  2  
DECORO OWL MIX 2  
**VIN20606** PZ 59,90



2,5x60  4  
LISTELLO OWL  
**VIN20607** PZ 19,90



VISION White Dec. Graph 20x60



# VISION



20x60  13  
VISION WHITE SAT.  
**VIN20050** F 42,90



20x60  13  
VISION SAND SAT.  
**VIN20200** F 42,90



20x60  13  
VISION MOS. RETTANGOLI SAND SAT.  
**VIN20201** F 46,90



20x60  13  
VISION STYLE SAND SAT.  
**VIN20203** F 46,90



20x60  13  
VISION LADY SAT.  
**VIN20250** F 42,90



2x60  4  
LIST. RETTANGOLI SAND SAT.  
**VIN20202** PZ 12,90



3x60  4  
LISTELLO STYLE SAND  
**VIN20204** PZ 13,90

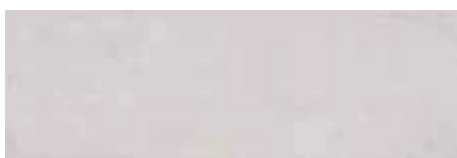

20x60  13  
VISION SILVER SAT.  
**VIN20100** F 42,90



20x60  13  
VISION MOS. RETTANGOLI SILVER SAT.  
**VIN20101** F 46,90



20x60  13  
VISION STYLE SILVER SAT.  
**VIN20103** F 46,90



20x60  13  
VISION SMOKE SAT.  
**VIN20150** F 42,90



2x60  4  
LIST. RETTANGOLI SILVER SAT.  
**VIN20102** PZ 12,90



3x60  4  
LISTELLO STYLE SILVER  
**VIN20104** PZ 13,90



20x60  2  
 DEC. SWEDEN SAT. MIX 2  
**VIN20051** PZ 29,90









20x60  2  
 DEC. LOVE SAT. MIX 2  
**VIN20052** PZ 29,90



20x60  2  
 DEC. POP SAT. MIX 2  
**VIN20053** PZ 29,90

#### IMBALLI / PACKAGING

FORMATO NOMINALE NOMINAL SIZE	 Thickness	 Pcs/Box	 Mq/Box	 Kg/Box	 Box/Pallet	 Mq/Pallet	 Kg/Pallet
20x60 / 8"x24"	9	13	1,56	26,56	44	68,64	1189

L'unità minima di vendita per tutti gli articoli (fondi, decori e pezzi speciali) è la scatola completa. / The minimum sales quantity for all items (plain tiles, decorations and special trims) is one full box. 273

# ATELIER

## BICOTTURA IN PASTA BIANCA

DOUBLE-FIRED WHITE BODY TILES

CLASSIFICAZIONE SECONDO NORME  
UNI EN 14411 (ISO 13006) ALLEGATO G-Gruppo BIII GL  
CLASSIFICATION IN ACCORDANCE  
WITH UNI EN 14411 (ISO 13006) ANNEX G-Group BIII GL

## FORMATI

SIZES



25x50



33,3x33,3 Kromie

Pavimento coordinato in gres porcellanato / Coordinating porcelain floor tiles



GRAFITE



GRAFITE/BIANCO

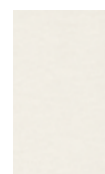

BIANCO



BIANCO/FRAGOLA



FRAGOLA



INDACO



INDACO/CIELO



CIELO



CIELO/GIADA



GIADA



VISONE



VISONE/BEIGE



BEIGE



BEIGE/ARANCIO



ARANCIO

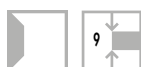

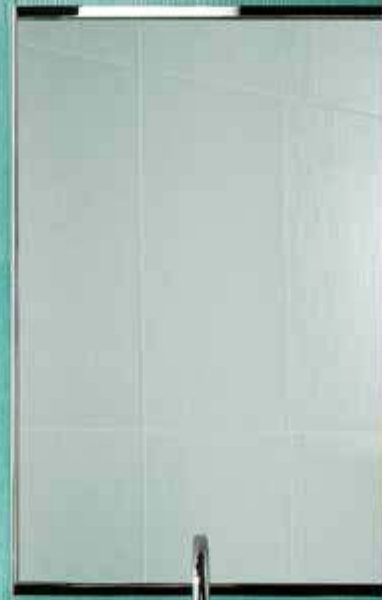





# ATELIER



25x50  12  
ATELIER GRAFITE  
**AE700** F 40,90



25x50  6  
DECORO JAQUARD FUOCO  
**AE801** PZ 65,90



25x50  12  
ATELIER GRAFITE / BIANCO  
**AE750** F 40,90



4,5x50  12  
LISTELLO JAQUARD FUOCO  
**AE802** PZ 19,90

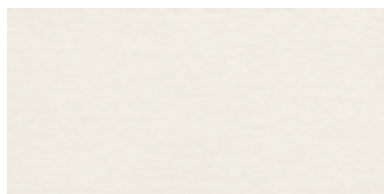

25x50  12  
ATELIER BIANCO  
**AE800** F 40,90



50x50  3 cp  
COMP. MOONFLOWER SINGLE BIANCO  
**AE805** PZ 129,90  
(prezzo a cp.)



25x50  12  
ATELIER BIANCO / FRAGOLA  
**AE850** F 40,90

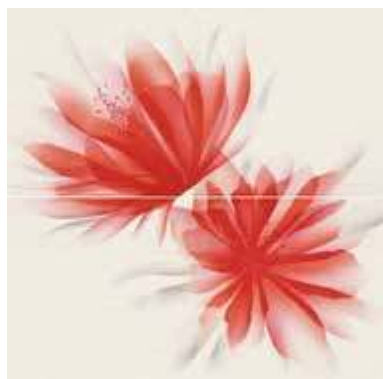

50x50  3 cp  
COMP. MOONFLOWER DOUBLE BIANCO  
**AE806** PZ 129,90  
(prezzo a cp.)



25x50  12  
ATELIER FRAGOLA  
**AE900** F 40,90



1x50  12  
MATITA ATELIER GRAFITE  
**AE703** PZ 11,90



1x50  12  
MATITA ATELIER FRAGOLA  
**AE903** PZ 11,90

Pavimento consigliato in gres porcellanato  
Recommended porcelain floor tiles



33,3x33,3  11  
KROMIE ROSSO  
**KR300** F 40,90



33,3x33,3  11  
KROMIE FUMO  
**KR450** F 40,90

# ATELIER



25x50  12  
ATELIER INDACO  
**AE400** F 40,90



25x50  6  
DECORO JAQUARD ACQUA  
**AE501** PZ 65,90



25x50  12  
ATELIER INDACO / CIELO  
**AE450** F 40,90



4,5x50  12  
LISTELLO JAQUARD ACQUA  
**AE502** PZ 19,90



25x50  12  
ATELIER CIELO  
**AE500** F 40,90



50x50  3 cp  
COMP. MOONFLOWER SINGLE CIELO  
**AE505** PZ 129,90  
(prezzo a cp.)



25x50  12  
ATELIER CIELO / GIADA  
**AE550** F 40,90



25x50  12  
ATELIER GIADA  
**AE600** F 40,90



50x50  3 cp  
COMP. MOONFLOWER DOUBLE CIELO  
**AE506** PZ 129,90  
(prezzo a cp.)



1x50  12  
MATITA ATELIER INDACO  
**AE403** PZ 11,90



1x50  12  
MATITA ATELIER GIADA  
**AE603** PZ 11,90



8x50  12  
LISTELLO GEMS ACQUA  
**AE507** PZ 45,90

Pavimento consigliato in gres porcellanato  
Recommended porcelain floor tiles



33,3x33,3  11  
KROMIE SMERALDO  
**KR350** F 40,90



33,3x33,3  11  
KROMIE LAVANDA  
**KR200** F 40,90



25x50  12  
ATELIER VISONE  
**AE100** F 40,90

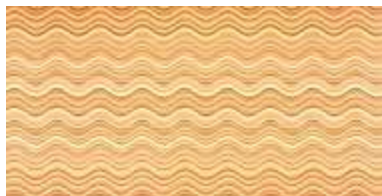

25x50  6  
DECORO JAQUARD TERRA  
**AE201** PZ 65,90



25x50  12  
ATELIER VISONE / BEIGE  
**AE150** F 40,90



4,5x50  12  
LISTELLO JAQUARD TERRA  
**AE202** PZ 19,90

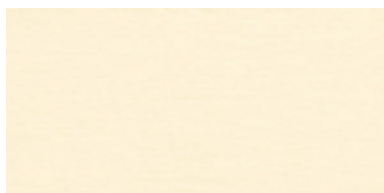

25x50  12  
ATELIER BEIGE  
**AE200** F 40,90



50x50  3 cp  
COMP. MOONFLOWER SINGLE BEIGE  
**AE205** PZ 129,90  
(prezzo a cp.)



25x50  12  
ATELIER BEIGE / ARANCIO  
**AE250** F 40,90









50x50  3 cp  
COMP. MOONFLOWER DOUBLE BEIGE  
**AE206** PZ 129,90  
(prezzo a cp.)



25x50  12  
ATELIER ARANCIO  
**AE300** F 40,90

#### IMBALLI / PACKAGING

FORMATO NOMINALE NOMINAL SIZE	 Thickness	 Pcs/Box	 Mq/Box	 Kg/Box	 Box/Pallet	 Mq/Pallet	 Kg/Pallet
25x50 / 10"x20"	9	12	1,50	24,00	39	58,50	956
33,3x33,3 / 13"x13"	9	11	1,22	24,00	44	53,68	1076

1x50  12  
MATITA ATELIER VISONE  
**AE103** PZ 11,90

1x50  12  
MATITA ATELIER ARANCIO  
**AE303** PZ 11,90



8x50  12  
LISTELLO GEMS TERRA  
**AE207** PZ 45,90

Pavimento consigliato in gres porcellanato  
Recommended porcelain floor tiles



33,3x33,3  11  
KROMIE ARANCIO  
**KR500** F 40,90



# VELVET

---

## BICOTTURA IN PASTA BIANCA

DOUBLE-FIRED WHITE BODY TILES

---

CLASSIFICAZIONE SECONDO NORME  
UNI EN 14411 (ISO 13006) ALLEGATO G-Gruppo BIII GL  
CLASSIFICATION IN ACCORDANCE  
WITH UNI EN 14411 (ISO 13006) ANNEX G-Group BIII GL

## FORMATI

SIZES



25x50

---



33,3x33,3

Pavimento coordinato in gres porcellanato / Coordinating porcelain floor tiles

---



AVORIO



SABBIA



BIANCO



TORTORA

---

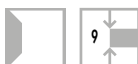



# VELVET



25x50  12  
VELVET AVORIO  
VSN33350 F 36,90



25x50  12  
VELVET SABBIA  
VSN33400 F 36,90



25x50  4  
DECORO LISTONI AVORIO  
VSN33352 PZ 5,90

Pavimento coordinato in gres  
porcellanato  
Coordinating porcelain floor tiles



25x50  4  
DECORO VELVET AVORIO  
VSN33360 PZ 5,90



25x50  2  
\* DECORO LUX AVORIO  
VSN33358 PZ 41,90



25x50  2  
\* DECORO ROMANCE GOLD  
VSN33359 PZ 41,90



33,3x33,3  11  
VELVET BEIGE  
VSN2715C F 31,90



6x25  6  
\* LISTELLO SOFT GOLD  
VSN33353 PZ 14,90



2,5x50  4  
\* LISTELLO LUX RAME  
VSN33357 PZ 15,90



5x50  4  
\* LISTELLO ROMANCE GOLD  
VSN33362 PZ 18,90



2x25  6  
\* LONDON SOFT GOLD  
VSN33354 PZ 12,90  
Lato superiore smaltato  
Glazed upper side



3x25  6  
\*\* FASCIA WENGÉ  
VSN33267 PZ 14,90



3x25  6  
\*\* FASCIA NOCE CANALETTO  
VSN33368 PZ 14,90

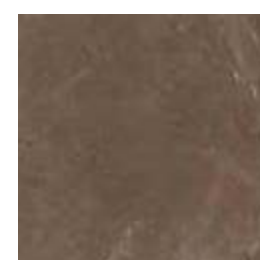

33,3x33,3  11  
VELVET TABACCO  
VSN2720C F 31,90



3x25  6  
\*\* FASCIA ROVERE SBIANCATO  
VSN33367 PZ 14,90

\* Si consiglia di pulire la superficie senza utilizzare prodotti contenenti sostanze abrasive per non alterare la brillantezza del metallo prezioso.  
Do not use products containing abrasive substances to clean the decorative element so as not to affect the shine of precious metal.

\*\* Decorazione realizzata in legno trattato e garantito per l'utilizzo nell'ambiente bagno. L'articolo è supportato da resine ecocompatibili che rendono possibile la posa in opera con normali colle ceramiche, fino ad oggi non utilizzabili per il legno. Il tipo di verniciatura fa in modo che non tema l'umidità, rendendo possibile la fugatura con normali stucchi ceramici epossidici. Dopo la posa in opera e la stuccatura, pulire il prima possibile con acqua avendo cura di asportare ogni residuo di stucco. Per mantenere inalterate nel corso del tempo le caratteristiche superficiali del prodotto si consiglia di pulirlo periodicamente con normali prodotti ravvivanti per mobili in legno e di non utilizzare detergenti abrasivi. Decorative tile made in treated wood, guaranteed also for use in the bathroom. Eco-compatible resins allow to place the product using standard pottery glues, which could not be used before. This kind of varnish protects from humidity, therefore it's possible filling with standard epossidic filler for ceramics. After placing and filling, please clean with water as soon as possible, carefully removing every mark left by the filler. In order to maintain over time the surface characteristics of product is recommended to periodically clean it with normal nourishing products for wooden furniture and do not use abrasive cleaners.



25x50 12  
VELVET BIANCO  
VSN33250 F 36,90



25x50 12  
VELVET TORTORA  
VSN33300 F 36,90



25x50 4  
DECORO LISTONI BIANCO  
VSN33252 PZ 5,90

Pavimento coordinato in gres  
porcellanato  
Coordinating porcelain floor tiles



25x50 4  
DECORO VELVET BIANCO  
VSN33260 PZ 5,90



3x25 6  
\*\* FASCIA WENGÉ  
VSN33267 PZ 14,90



25x50 2  
\* DECORO ROMANCE SILVER  
VSN33259 PZ 41,90



33,3x33,3 11  
VELVET GRIGIO  
VSN2705C F 31,90



6x25 6  
\* LISTELLO SOFT SILVER  
VSN33253 PZ 14,90



5x50 4  
\* LISTELLO ROMANCE SILVER  
VSN33262 PZ 18,90

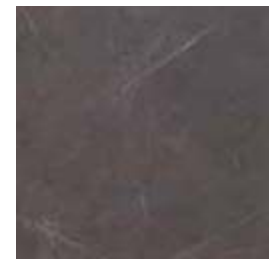

33,3x33,3 11  
VELVET ANTRACITE  
VSN2710C F 31,90



2x25 6  
\* LONDON SOFT SILVER  
VSN33254 PZ 12,90  
Lato superiore smaltato  
Glazed upper side

## IMBALLI / PACKAGING

FORMATO NOMINALE NOMINAL SIZE	Thickness	Pcs/Box	Mq/Box	Kg/Box	Box/Pallet	Mq/Pallet	Kg/Pallet
25x50 / 10"x20"	9	12	1,50	22,30	39	58,50	890
33,3x33,3 / 13"x13"	9	11	1,22	24,00	44	53,68	1076

L'unità minima di vendita per tutti gli articoli (fondi, decori e pezzi speciali) è la scatola completa. / The minimum sales quantity for all items (plain tiles, decorations and special trims) is one full box. 283

# ZANZIBAR

---

## BICOTTURA IN PASTA BIANCA

DOUBLE-FIRED WHITE BODY TILES

---

CLASSIFICAZIONE SECONDO NORME  
UNI EN 14411 (ISO 13006) ALLEGATO G-Gruppo BIII GL  
CLASSIFICATION IN ACCORDANCE  
WITH UNI EN 14411 (ISO 13006) ANNEX G-Group BIII GL

## FORMATI

SIZES



20x50



50x50



33,3x33,3

Pavimento coordinato in gres porcellanato / Coordinating porcelain floor tiles ( pag. 214 )

---



SABBIA CHIARO



SABBIA SCURO



GRIGIO CHIARO



GRIGIO SCURO

---





# ZANZIBAR



20x50  15  
ZANZIBAR SABBIA CHIARO  
**ZA100** F 36,90



20x50  15  
ZANZIBAR SABBIA SCURO  
**ZA150** F 36,90



20x50  6  
\* FASCIA ODALISCA SABBIA/OCRA  
**ZA115** PZ 41,90



2,5x25  12  
LISTELLO REEF SABBIA/GRIGIO  
**ZA101** PZ 14,90





3x50  6  
\* LISTELLO ODALISCA SABBIA/OCRA  
**ZA116** PZ 14,90



20x50  12  
FORO ZANZIBAR SABBIA  
**ZA120** PZ 8,90



5x20  12  
LIST. ZANZIBAR SABBIA (vetro - glass)  
**ZA122** PZ 25,90

5x10  12  
TOZZ. ZANZIBAR SABBIA (vetro - glass)  
**ZA121** PZ 18,90

Pavimento coordinato in gres porcellanato a pagina 216  
Coordinating porcelain floor tiles page 216



33,3x33,3  11  
ZANZIBAR SABBIA CHIARO  
**ZA6000C** F 31,90



33,3x33,3  11  
ZANZIBAR SABBIA SCURO  
**ZA6500C** F 31,90

\*Si consiglia di pulire la superficie senza utilizzare prodotti contenenti sostanze abrasive per non alterare la brillantezza del metallo prezioso.  
Do not use products containing abrasive substances to clean the decorative element so as not to affect the shine of the precious metal.



20x50 15  
ZANZIBAR GRIGIO CHIARO  
**ZA200** F 36,90



20x50 15  
ZANZIBAR GRIGIO SCURO  
**ZA250** F 36,90



20x50 6  
\* FASCIA ODALISCA GRIGIO  
**ZA215** PZ 41,90



2,5x25 12  
LISTELLO REEF SABBIA/GRIGIO  
**ZA101** PZ 14,90



3x50 12  
\* LISTELLO ODALISCA GRIGIO  
**ZA216** PZ 14,90



20x50 12  
FORO ZANZIBAR GRIGIO  
**ZA220** PZ 8,90



5x50 12  
\* LISTELLO ATOLLI GRIGIO  
**ZA205** PZ 41,90



5x20 12  
LIST. ZANZIBAR GRIGIO (vetro - glass)  
**ZA222** PZ 25,90



2,5x50 12  
\* CORDONE ATOLLI GRIGIO  
**ZA206** PZ 28,90

5x10 12  
TOZZ. ZANZIBAR GRIGIO (vetro - glass)  
**ZA221** PZ 18,90



33,3x33,3 11  
ZANZIBAR GRIGIO CHIARO  
**ZA6050C** F 31,90



33,3x33,3 11  
ZANZIBAR GRIGIO SCURO  
**ZA6550C** F 31,90

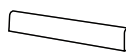

10x50 18  
BULLNOSE PZ 12,90

**ZA401** | SABBIA CHIARO  
**ZA451** | SABBIA SCURO  
**ZA501** | GRIGIO CHIARO  
**ZA551** | GRIGIO SCURO

## IMBALLI / PACKAGING

FORMATO NOMINALE NOMINAL SIZE	Thickness	Pcs/Box	Mq/Box	Kg/Box	Box/Pallet	Mq/Pallet	Kg/Pallet
20x50 / 8"x20"	9	15	1,50	24,00	44	66,00	1076
33,3x33,3 / 13"x13"	9	11	1,22	24,00	44	53,68	1076

L'unità minima di vendita per tutti gli articoli (fondi, decori e pezzi speciali) è la scatola completa. / The minimum sales quantity for all items (plain tiles, decorations and special trims) is one full box. 287



---

20  
15

---

**#MY  
ABK**

|

BUILDING SOLUTIONS

---

_____	290	LEVEL
_____	296	PLAY WOOD
_____	302	WOODWAY 60

---

# LEVEL

## GRES PORCELLANATO A MASSA COLORATA

FULL BODY COLOURED PORCELAIN STONEWARE

CLASSIFICAZIONE SECONDO NORME  
UNI EN 14411 (ISO 13006) ALLEGATO G-Gruppo B1a  
CLASSIFICATION IN ACCORDANCE  
WITH UNI EN 14411 (ISO 13006) ANNEX G-Group B1a

## SUPERFICI E FINITURE

SURFACES AND FINISHES

Naturale / Natural  
Naturale rettificato / Natural rectified

## FORMATI

SIZES



60x60



30x60

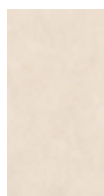

IVORY



GREY



SILVER



BLACK



DIN 51130



ASTM C 1028



B.C.R.A.



*soup & salad*

SALAD - SHRIMP SALAD - CAESAR SALAD - CHICKEN SALAD - TUNA SALAD - CAESAR SALAD  
SALAD - ASIAN SALAD - CHOPPED SALAD  
CHEF SALAD - COMBO SALAD - TOSSED SALAD  
SOUP - SHORPEIDGE - MUSHROOM and BRIE  
NEW ENGLAND CLAM CHOWDER

A



# LEVEL

## IVORY



60,4x60,4  4  
LEVEL IVORY

**LEN01050** nat. F 33,90

60x60  4  
LEVEL IVORY

**LER0105A** rett. F 40,90



30x60,4  7  
LEVEL IVORY

**LEN03050** nat. F 31,90

30x60  7  
LEVEL IVORY

**LER0305A** rett. F 38,90



30x30  6  
MOS. QUADRETTI LEVEL IVORY

**LER09051** F 101,90



30x30  4  
MOS. BRICK LEVEL IVORY/GREY

**LER09052** rett. PZ 17,90

1,5x60  2  
MATITA METAL

**DWR01001** rett. PZ 15,90

## GREY

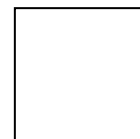

60,4x60,4  4  
LEVEL GREY

**LEN01150** nat. F 33,90

60x60  4  
LEVEL GREY

**LER0115A** rett. F 40,90



30x60,4  7  
LEVEL GREY

**LEN03150** nat. F 31,90

30x60  7  
LEVEL GREY

**LER0315A** rett. F 38,90



30x30  6  
MOS. QUADRETTI LEVEL GREY

**LER09151** F 101,90



30x30  4  
MOS. BRICK LEVEL IVORY/GREY

**LER09052** rett. PZ 17,90

1,5x60  2  
MATITA METAL

**DWR01001** rett. PZ 15,90

# SILVER

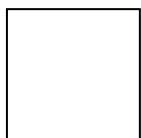

60,4x60,4  4  
LEVEL SILVER

**LEN01100** nat. F 33,90

60x60  4  
LEVEL SILVER

**LER0110A** rett. F 40,90



30x60,4  7  
LEVEL SILVER

**LEN03100** nat. F 31,90

30x60  7  
LEVEL SILVER

**LER0310A** rett. F 38,90



30x30  6  
MOS. QUADRETTI LEVEL SILVER

**LER09101** F 101,90



30x30  4  
MOS. BRICK LEVEL SILVER/BLACK

**LER09102** rett. PZ 17,90

1,5x60  2  
MATITA METAL

**DWR01001** rett. PZ 15,90

# BLACK

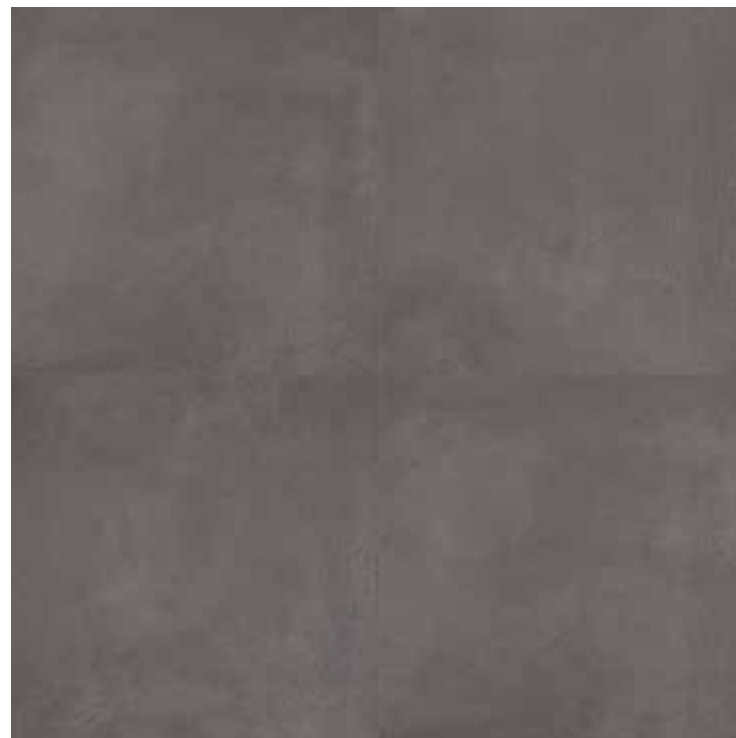

60,4x60,4  4  
LEVEL BLACK

**LEN01200** nat. F 33,90

60x60  4  
LEVEL BLACK

**LER0120A** rett. F 40,90



30x60,4  7  
LEVEL BLACK

**LEN03200** nat. F 31,90

30x60  7  
LEVEL BLACK

**LER0320A** rett. F 38,90



30x30  6  
MOS. QUADRETTI LEVEL BLACK

**LER09201** F 101,90



30x30  4  
MOS. BRICK LEVEL SILVER/BLACK

**LER09102** rett. PZ 17,90

1,5x60  2  
MATITA METAL







**DWR01001** rett. PZ 15,90



## PEZZI SPECIALI / SPECIAL TRIMS

		LEVEL IVORY	LEVEL GREY	LEVEL SILVER	LEVEL BLACK
	BATTISCOPA rett. 6,5x60,4 PZ 7,90  8	<b>LEN01051</b>	<b>LEN01151</b>	<b>LEN01101</b>	<b>LEN01201</b>

## IMBALLI / PACKAGING

FORMATO NOMINALE NOMINAL SIZE	FORMATO REALE REAL SIZE	 Thickness	 Pcs/Box	 Mq/Box	 Kg/Box	 Box/Pallet	 Mq/Pallet	 Kg/Pallet
60,4x60,4 / 24"x24" nat.	-	9	4	1,46	25,55	32	46,72	818
60x60 / 24"x24" rett.	59,5x59,5	9	4	1,44	25,20	32	46,08	806
30x60,4 / 12"x24" nat.	-	9	7	1,27	22,23	40	50,80	889
30x60 / 12"x24" rett.	29,6x59,5	9	7	1,26	22,05	40	50,40	882

L'unità minima di vendita per tutti gli articoli (fondi, decori e pezzi speciali) è la scatola completa. / The minimum sales quantity for all items (plain tiles, decorations and special trims) is one full box. Pezzi speciali e decori per effetto delle lavorazioni, possono presentare variazioni di tonalità. / Due to working process special trims and decors, may show variation in tonality.

## SIGILLANTI COORDINATI PER FUGHE / COORDINATED GROUT SEALANTS

**HARDKOLL**

CODICE SIGILLANTE SEALANT CODE	ABBINAMENTO MATCHING
SI217M kromos grigio luce 0-8	Level Ivory
SI220B kromos antracite 0-8	Level Grey
SI219B kromos grigio cemento 0-8	Level Silver
SI220B kromos antracite 0-8	Level Black



# PLAYWOOD

## GRES PORCELLANATO

PORCELAIN STONEWARE

CLASSIFICAZIONE SECONDO NORME  
UNI EN 14411 (ISO 13006) ALLEGATO G-Gruppo Bla GL  
CLASSIFICATION IN ACCORDANCE  
WITH UNI EN 14411 (ISO 13006) ANNEX G-Group Bla GL

## SUPERFICI E FINITURE

SURFACES AND FINISHES

Naturale / Natural

## FORMATI

SIZES



20,2x80,2



BONE



EARTH



GREY





# PLAYWOOD

BONE

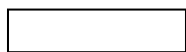



20,2x80,2  7  
PLAYWOOD BONE

**PWN49050** nat.

F 41,90

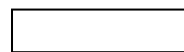
EARTH





20,2x80,2  7  
PLAYWOOD EARTH

**PWN49100** nat.

F 41,90

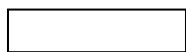
## PLAYWOOD GREY



20,2x80,2  7  
PLAYWOOD GREY

**PWN49150** nat.

F 41,90









# PLAYWOOD

## PEZZI SPECIALI / SPECIAL TRIMS

				
		PLAYWOOD BONE	PLAYWOOD EARTH	PLAYWOOD GREY
	BATTISCOPA 6,5x80,2 PZ 8,90  8	<b>PWN49051</b>	<b>PWN49101</b>	<b>PWN49151</b>

## IMBALLI / PACKAGING

FORMATO NOMINALE NOMINAL SIZE	FORMATO REALE REAL SIZE	 Thickness	 Pcs/Box	 Mq/Box	 Kg/Box	 Box/Pallet	 Mq/Pallet	 Kg/Pallet
20,2x80,2 / 8"x32"	-	9	7	1,14	21,89	42	47,88	940

L'unità minima di vendita per tutti gli articoli (fondi, decori e pezzi speciali) è la scatola completa. / The minimum sales quantity for all items (plain tiles, decorations and special trims) is one full box.  
Pezzi speciali e decori per effetto delle lavorazioni, possono presentare variazioni di tonalità. / Due to working process special trims and decors, may show variation in tonality.

## SIGILLANTI COORDINATI PER FUGHE / COORDINATED GROUT SEALANTS

**HARD KOLL**

CODICE SIGILLANTE SEALANT CODE	ABBINAMENTO MATCHING
SI234B kromos bahama beige 0-8	Playwood bone / earth
SI218B kromos manhattan 0-8	Playwood grey

# WOODWAY 60

## GRES PORCELLANATO

PORCELAIN STONEWARE

CLASSIFICAZIONE SECONDO NORME  
UNI EN 14411 (ISO 13006) ALLEGATO G-Gruppo Bla GL  
CLASSIFICATION IN ACCORDANCE  
WITH UNI EN 14411 (ISO 13006) ANNEX G-Group Bla GL

## SUPERFICI E FINITURE

SURFACES AND FINISHES

Naturale / Natural

## FORMATI

SIZES



15x60



OAK MILK



OAK HONEY



OAK CHERRY



DIN 51130  
naturale



DIN 51097  
naturale



ASTM C 1028  
naturale



B.C.R.A.  
naturale



V2





# WOODWAY 60

OAK MILK



15x60  16  
WOODWAY OAK MILK  
**WON0405B** nat. F 40,90

OAK HONEY

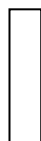

15x60  16  
WOODWAY OAK HONEY  
**WON0410B** nat. F 40,90

OAK CHERRY

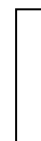







15x60  16  
WOODWAY OAK CHERRY  
**WON0415B** nat. F 40,90

# WOODWAY 60

## PEZZI SPECIALI / SPECIAL TRIMS

				
		OAK MILK	OAK HONEY	OAK CHERRY
	BATTISCOPIA 7,5x60 PZ 7,90  10	<b>WON0105S</b>	<b>WON0110S</b>	<b>WON0115S</b>

## IMBALLI / PACKAGING

FORMATO NOMINALE NOMINAL SIZE	FORMATO REALE REAL SIZE	 Thickness	 Pcs/Box	 Mq/Box	 Kg/Box	 Box/Pallet	 Mq/Pallet	 Kg/Pallet
15x60 / 6"x24"	-	9	16	1,44	25,20	40	57,60	1028

L'unità minima di vendita per tutti gli articoli (fondi, decori e pezzi speciali) è la scatola completa. / The minimum sales quantity for all items (plain tiles, decorations and special trims) is one full box. Pezzi speciali e decori per effetto delle lavorazioni, possono presentare variazioni di tonalità. / Due to working process special trims and decors, may show variation in tonality.

## SIGILLANTI COORDINATI PER FUGHE / COORDINATED GROUT SEALANTS

**HARDKOLL**

CODICE SIGILLANTE SEALANT CODE	ABBINAMENTO MATCHING
SI238B kromos tabacco 0-8	Oak honey
SI128B kromos cotto 0-8	Oak cherry

---

20  
15

---

#MY  
ABK



AREA INFORMATIVA

INFORMATION AREA

---

308	ECOSOSTENIBILITÀ ECO-SUSTAINABILITY
310	NUOVI SISTEMI DI POSA NEW LAYING SYSTEM
318	CARATTERISTICHE TECNICHE TECHNICAL CHARACTERISTICS
322	POSA LAYING
323	PULIZIA E MANUTENZIONE CLEANING AND MAINTENANCE
325	SIMBOLOGIA SYMBOLS
326	CONDIZIONI GENERALI DI VENDITA GENERAL SALES TERMS AND CONDITIONS

---

## ECOSOSTENIBILITÀ / ECO-SUSTAINABILITY



Per ABK essere all'avanguardia oggi significa anche saper coniugare i processi industriali con il rispetto per l'ambiente in cui viviamo, questo impegno etico e civile si traduce mantenendo costantemente i propri parametri al di sotto dei limiti consentiti dalle normative vigenti.

I Love Green nasce da questo importante obiettivo.

Un modo autentico di coniugare un alto profilo tecnologico e l'amore per l'ambiente ed il territorio attraverso cinque differenti azioni concrete:

- emissioni in atmosfera ridotte al minimo grazie all'utilizzo di sofisticate tecnologie per l'abbattimento dei fumi;
- nessun scarico idrico nell'ambiente mediante un circuito di acque chiuse che riutilizza completamente i liquidi all'interno del ciclo industriale;
- i residui della lavorazione degli smalti e delle materie prime sono integralmente reimpiegati nel ciclo produttivo;
- riduzione dei consumi di energia attraverso appositi dispositivi di recupero termico degli impianti;
- abbattimento delle emissioni di anidride carbonica.

Questo impegno sta producendo importanti risultati tangibili che, oltre a rispettare le severe normative imposte dalle autorità competenti in materia di rispetto per l'ambiente, ci permettono di realizzare performance ambientali migliori rispetto agli standard di riferimento del settore ceramico.





For ABK, being at the forefront today also means being able to combine its industrial processes with respect for the environment in which we live; this ethical and social commitment means constantly keeping its parameters below the legal limits.

I Love Green originates from this important goal.

It offers an authentic way to combine a high technology profile and love for the environment and local area through five different concrete actions,

- atmospheric emissions minimised by the use of sophisticated fume abatement technology;
- no draining water into the environment thanks to a closed-circuit water system that reuses the fluids completely in the industrial cycle;
- glazing and raw material wastes entirely reused in the production cycle;
- reduction of energy consumption through appropriate heat recovery devices in the systems;
- carbon dioxide emissions abatement.

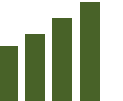
This commitment is producing major, tangible results which, as well as meeting the stringent regulations imposed by environmental authorities, enable us to achieve better environmental performance levels than the reference standards in the ceramics sector.

		MEDIA SETTORE* SECTOR AVERAGE*	ABK	MEDIA SETTORE* SECTOR AVERAGE*	ABK	MEDIA SETTORE* SECTOR AVERAGE*	ABK
 <b>EMISSIONI IN ATMOSFERA EMISSIONS TO AIR</b>		EMISSIONI IN ATMOSFERA DI MATERIALE PARTICELLATO PARTICULATE MATTER EMISSIONS	g/m <sup>2</sup>	g/m <sup>2</sup>	EMISSIONI IN ATMOSFERA DI COMPOSTI DEL FLUORO FLUORIDE EMISSIONS	mg/m <sup>2</sup>	mg/m <sup>2</sup>
	GRES PORCELLANATO CICLO COMPLETO FULLY FINISHED PORCELAIN TILES	2,15	0,92	0,15	0,03	4,5	0,1
	BICOTTURA DOUBLE-FIRED WALL TILES	0,73	0,03	0,21	0,02	2,8	0,1
 <b>UTILIZZO DELL'ACQUA WATER USAGE</b>		RAPPORTO DI RICICLO DELLE ACQUE REFLUE WASTEWATER RECYCLE RATIO	%	%	COPERTURA CON ACQUE REFLUE DEL FABBISOGNO IDRICO PER LA PREPARAZIONE DELL'IMPASTO USE OF WASTEWATER TO MEET WATER REQUIREMENTS FOR THE PREPARATION OF TILE BODY	L/m <sup>2</sup>	L/m <sup>2</sup>
	GRES PORCELLANATO CICLO COMPLETO FULLY FINISHED PORCELAIN TILES	98	100	58	65	10	7,2
	BICOTTURA DOUBLE-FIRED WALL TILES	94	100			5,8	0,4
 <b>RICICLO DEI RIFIUTI/RESIDUI DI FABBRICAZIONE RECYCLING OF WASTE PROCESS MATERIALS</b>		PRODUZIONE SPECIFICA DEI FANGHI DA DEPURAZIONE CERAMIC PRODUCTION USING PURIFICATION SLURRY	Kg/m <sup>2</sup>	Kg/m <sup>2</sup>	RICICLO DEGLI SMALTI E DELLE MATERIE PRIME PER L'IMPASTO RECYCLING OF GLAZES AND RAW MATERIALS USED FOR TILE BODY	%	%
	GRES PORCELLANATO CICLO COMPLETO FULLY FINISHED PORCELAIN TILES	0,4	0,1	-	100		
	BICOTTURA DOUBLE-FIRED WALL TILES	0,8	0,4	-	100		
 <b>CONSUMI DI ENERGIA ENERGY CONSUMPTION</b>		CONSUMO TOTALE ANNUO DI ENERGIA ELETTRICA TOTAL ANNUAL ELECTRICAL ENERGY CONSUMPTION	TJ/anno TJ/year	TJ/anno TJ/year	CONSUMO TOTALE ANNUO DI GAS NATURALE TOTAL ANNUAL CONSUMPTION OF NATURAL GAS	TJ/anno TJ/year	TJ/anno TJ/year
	GRES PORCELLANATO CICLO COMPLETO FULLY FINISHED PORCELAIN TILES	52	51	429	329		
	BICOTTURA DOUBLE-FIRED WALL TILES	21	5	162	36		
 <b>EMISSIONI DI CO<sub>2</sub> CO<sub>2</sub> EMISSIONS</b>		EMISSIONE DI ANIDRIDE CARBONICA DA COMBUSTIONE DI GAS NATURALE CO <sub>2</sub> EMISSIONS PRODUCED BY THE COMBUSTION OF NATURAL GAS	t/anno t/year	t/anno t/year			
	GRES PORCELLANATO CICLO COMPLETO FULLY FINISHED PORCELAIN TILES	21.775	16.033				
	BICOTTURA DOUBLE-FIRED WALL TILES	8.137	1.776				

\*: Campione rappresentativo delle aziende del distretto ceramico

308 \*: Ceramic tile manufacturer community sample

fonte: Secondo Rapporto Integrato per l'industria italiana delle piastrelle di ceramica - Sassuolo 2008  
source: Integrated Report for the ceramic-tile manufacturing Italian industry - Sassuolo 2008

# LA GARANZIA DI UN FUTURO GREEN BUILDING PASSA ATTRAVERSO LA QUALITA' ECO-SOSTENIBILE.

## THE FUTURE OF GREEN BUILDING IS GUARANTEED BY ECO-SUSTAINABLE QUALITY.

Da azienda sensibile alle tematiche ambientali, ABK si è sempre preoccupata di mantenere i parametri che regolano i processi industriali al di sotto delle normative, composto al 40% minimo da materiale riciclato recuperato da altre lavorazioni industriali. ECO-BODY è ufficialmente certificato per recepire gli standard LEED (Leadership in Energy and Environmental Design) il sistema di rating internazionale delle performance ambientali che in edilizia promuove la progettazione sostenibile riguardante l'intero edificio per ridurre l'impatto ambientale per tutto il suo ciclo di vita. Tutte le collezioni ABK che utilizzano questo speciale impasto certificato, riportano nella pagina riepilogativa l'esclusivo logo ECO-BODY, che oltre ad indicare il 40% minimo di materiale riciclato, ne evidenziano la compatibilità col sistema di crediti LEED.

ABK è membro di GREEN BUILDING COUNCIL ITALIA, l'associazione italiana dei leader che operano per trasformare il mercato dell'edilizia verso la sostenibilità ambientale e per costruire comunità vivibili. I soci GBC Italia promuovono la responsabilità ambientale, economica e sociale innovando il modo in cui gli edifici sono progettati, realizzati e utilizzati.

As a company that cares deeply about environmental issues, ABK has always endeavoured to keep its parameters below the legal limits for manufacturing processes, utilising a minimum of 40% recycled material recovered from other industrial processes. ECO-BODY is officially certified for access to LEED (Leadership in Energy and Environmental Design) credits, the international rating system for environmental performance which promotes sustainable design in the construction industry with a view to reducing the overall environmental impact of buildings over their entire life cycle. All ABK collections made with this special certified mix are identified in the contents page with the exclusive ECO-BODY logo, which in addition to indicating a minimum of 40% recycled material, underlines the product's compatibility with the LEED credits system. ABK is a member of Italian GREEN BUILDING COUNCIL, the association of top players working to transform the building market towards sustainability and to build liveable communities. GBC Italian members promote environmental, economic and social responsibility, innovating buildings in terms of engineering, design, manufacturing and use.



# IL GRANDE FORMATO SENZA PREGIUDIZI. UNA NUOVA TECNOLOGIA PER SOLUZIONI DI POSA SEMPRE PIU' FACILI.

LARGE SIZES WITHOUT ANY  
DRAWBACKS. NEW TECHNOLOGY  
FOR EASIER-THAN-EVER INSTALLATION  
SOLUTIONS.

All'interno delle proprie collezioni più prestigiose ABK dà spazio ai grandi formati rettificati 40x170, corredati dai sottomultipli 20x170 e 20x120. La produzione di questi formati avviene utilizzando materie prime ad elevata plasticità, che permettono di ottenere lastre particolarmente flessibili. Questa flessibilità si traduce in un minimo grado di convessità che ne facilita la posa, consentendone una maggiore adattabilità alle condizioni del sottofondo. Una volta posate sul massetto queste piastrelle si auto-livellano per il loro stesso peso. L'installazione risulta più semplice e, indipendentemente dallo schema di posa, la superficie risulterà sempre perfettamente planare.

In its most prestigious collections, ABK also includes large ground slabs sized 40x170, complete with matching smaller tiles sized 20x170 and 20x120. These larger sizes are produced using raw materials characterised by high plasticity, which enables the slabs to be particularly flexible. This flexibility translates into a minimum level of convexity which facilitates installation, enabling greater adaptability to substrate conditions. When laid on the screed, these tiles self-level due to their own weight. Installation is easier and, irrespective of the laying pattern, the surface will always be perfectly level.

## AUTO-LEVELING

 **Facile installazione - Easy laying**



Tutti i prodotti Auto-Leveling possono essere montati seguendo il sistema Insta-Tile, un nuovo metodo di posa a secco che consiste nel fissaggio del materiale direttamente sul pavimento preesistente, senza alcuna opera di demolizione. Si inizia posizionando l'apposito tappetino dello spessore di circa 2mm tra il pavimento e la lastra auto-livellante e, mantenendo una distanza di 5mm da tutte le pareti interessate, si prosegue con la posa delle piastrelle, senza creare alcun tipo di fuga tra una e l'altra, praticando tutti i tagli necessari fino a coprire completamente il vecchio pavimento. A questo punto si procederà con l'inserimento del profilo stabilizzante che andrà a colmare la distanza lasciata dai muri per tutto il perimetro per rendere completamente stabile il nuovo pavimento, la cui superficie risulterà perfettamente planare anche senza l'utilizzo di colle e sigillanti. Il pavimento Insta-Tile potrà così essere facilmente rimosso e recuperato in qualsiasi momento.

Per maggiori informazioni sulla tecnologia Auto-leveling e sul sistema di posa Insta-Tile puoi effettuare il download del filmato ufficiale di presentazione su [www.abk.it](http://www.abk.it)

All Auto-Leveling products can be installed following the Insta-Tile system, a new dry installation method which consists of fixing the material directly to the existing floor, without the need for any demolition work. First of all, the specially designed 2-mm thick mat is laid between the floor and the self-leveling slab then, leaving a distance of 5 mm from all perimeter walls, the tiles are laid without any joints in between, making all the cuts necessary to completely cover the existing floor. Next, the stabilising edging is fitted, filling the distance left between the edge of the tiles and the perimeter walls: this makes the new floor completely stable and the surface perfectly level, even without the use of adhesives and sealants. The Insta-Tile floor can thus be easily removed and recovered for use elsewhere as and when required.

For further information on Auto-leveling technology and the Insta-Tile installation system, download the official presentation video on the website [www.abk.it](http://www.abk.it)



**INSTA-TILE**  
 **DRY FIXING**

# ACCESSORI PER POSA A SECCO INSTA-TILE

ACCESSORY FOR DRY FIXING INSTA-TILE

## Tappetini per sottopavimento in rotolo

Codice Code	Misura Size	Prezzo Price	imb.	confezione packaging
TPPOL1X	TAPPETO POLIETILENE ANTRACITE 2,5 mm rotolo dimensione 1,50x25,00 m	11,50 / mq	1	rotolo da 37,5 mq
TPPSUG1X	TAPPETO SUGHERO NATURALE 2 mm rotolo dimensione 1,00x30,00 m	10,50 / mq	1	rotolo da 30 mq

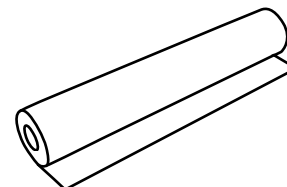

TAPPETO POLIETILENE ANTRACITE 2,5 mm



TAPPETO SUGHERO NATURALE 2 mm

## Elementi di finitura

Codice Code	Misura Size	Prezzo Price	imb.	confezione packaging
RACALL1X	RACCORDO ALLUMINIO ANODIZZ. PAVIMENTO/PARETE barra di lunghezza 1,20 m · h = 4,5 mm	14,70 / pz	5	scatola da 5 pz
TERALL1X	TERMINALE di DISLIVELLO ALLUMINIO ANODIZZ. barra di lunghezza 1,20 m · h = 11 mm	17,30 / pz	5	scatola da 5 pz
PRFALL1X	PROFILO di DISLIVELLO ALLUMINIO ANODIZZ. barra di lunghezza 1,20 m · h = 10 mm	18,00 / pz	5	scatola da 5 pz

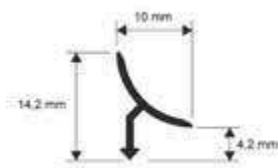

RACCORDO PAVIMENTO/PARETE



TERMINALE DI DISLIVELLO



PROFILO DI DISLIVELLO



# SUPPORTI PER PAVIMENTI SOPRAELEVATI DA ESTERNO

## Lastre in Gres Porcellanato 20 mm

Le lastre in gres porcellanato ABK da 20 mm di spessore, garantiscono un'elevata resistenza allo scivolamento, inalterabilità ed un'ottima durata nel tempo in qualunque condizione climatica. Il posizionamento di queste lastre è realizzabile in maniera tradizionale, a secco su ghiaia, erba e sabbia, oppure con posa sopraelevata.

## Sistema di posa sopraelevata da esterno

Il sistema di pavimentazione sopraelevata prevede l'utilizzo di supporti portanti di tipo autolivellante, regolabili oppure fissi che si adattano con semplicità e sicurezza ad ogni tipo di pavimento sottostante.

Il sistema permette la realizzazione di piani di posa con altezze variabili, da terra, comprese fra 25 e 270 mm.

## Vantaggi

- » L'indipendenza della pavimentazione dai supporti garantisce l'assorbimento di eventuali movimenti strutturali.
- » Il sistema sopraelevato non necessita di massetto in cemento e consente una diminuzione del peso sulla struttura portante.
- » Le fughe aperte tra una piastrella ed un'altra consentono un facile deflusso dell'acqua piovana evitando tutti i rischi di accumulo o di ristagno.
- » La presenza dell'intercapedine fra il piano di calpestio e il piano di appoggio favorisce l'aerazione e l'isolamento termico.
- » Questa soluzione permette inoltre il passaggio di impianti e tubazioni nell'intercapedine, e la facile ispezione degli stessi una volta installata la pavimentazione.

## ADJUSTABLE SUPPORTS FOR RAISED FLOORS

## 20 mm Porcelain Stoneware Slabs

The 20 mm thick porcelain stoneware slabs by ABK guarantee high slip-resistance, long life and they do not alter in appearance, whatever the weather.

These slabs can be dry laid in a traditional manner on gravel, grass and sand or used for raised solutions.

## Outdoor raised laying system

The raised floor system foresees the use of self-levelling, adjustable or fixed load bearing supports that easily adapt to the floor below in total safety.

The system is suitable to create laying designs with variable heights from the ground, which range between 25 and 270 mm.

## Advantages

- » The independence of the flooring from the supports guarantees the absorption of any structural movements.
- » The raised system does not require a cement screed and reduces the load on the bearing structure.
- » The open joints between the tiles allow rainwater to easily drain off, avoiding any risk of water accumulation or stagnation.
- » The gap between the tread surface and the support surface favours ventilation and heat insulation.
- » This solution allows for the installation of systems and piping in the gap, which can be easily inspected even once the floor has been installed.

# TANTI VANTAGGI IN UN UNICO ELEMENTO

MANY BENEFITS IN ONE SINGLE ELEMENT

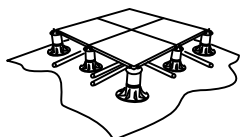

**Ottimo nascondiglio per tubi ed impianti**  
Excellent for hiding pipes and equipment

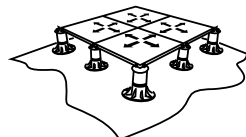

**Ottimo assorbimento delle dilatazioni**  
Excellent absorption of structural movements

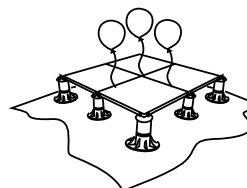

**Significativa diminuzione del peso**  
Significant less weight

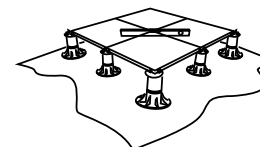

**Pavimento sempre piano e facilmente ispezionabile**  
Always a flat paving and easily accessible

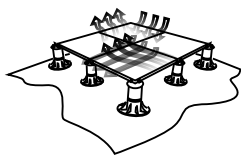

**Migliore isolamento termico**  
Better thermal insulation



**Rapido deflusso dell'acqua**  
Quick water drainage

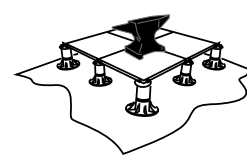

**Forte resistenza ai pesi**  
Exceptional load bearing strength

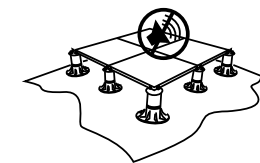

**Miglior isolamento acustico**  
The best sound insulation



Chiave di regolazione rinforzata per una regolazione millimetrica anche a pavimento posato.  
*Reinforced adjustment key to be used even when paving is finished.*



Alette preincise per una facile asportazione.  
*Pre-cut tabs for easy remove.*



Aggancio testa-vite: la testa sempre in sede.  
*Coupling head to screw attachment system.*



Testa in bi-materiale PP+gomma anti-rumore e anti-scivolamento.  
*Bi-material head PP + rubber anti-noise and anti-slip.*

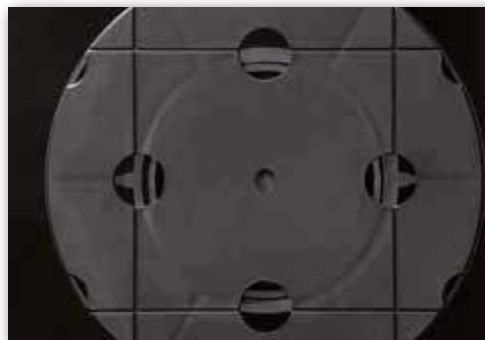

Base di appoggio con linee di taglio preincise. - *Base bottom with pre-cut lines.*



# SRA SUPPORTO AUTOLIVELLANTE REGOLABILE CON TESTA IN BIMATERIALE (PP+GOMMA)

ADJUSTABLE PAVING SUPPORT WITH SELF-LEVELLING BI-MATERIAL HEAD

## Vantaggi

- » Testa autolivellante che compensa automaticamente pendenze fino al 5%;
- » Regolabile da 37,5 a 215mm con pavimento finito grazie all'esclusiva chiave di regolazione;
- » Base di appoggio liscia di 320cm<sup>2</sup>;
- » Totalmente riciclabile;
- » Resistente a temperature da -40° a +120°C;
- » Resistente agli acidi, all'invecchiamento, ai raggi UV;
- » Utilizzabile con qualsiasi pavimentazione da esterno autoportante;
- » Protetto da BREVETTO internazionale;
- » Testa con parte superiore in gomma antirumore ed antiscivolamento;
- » Alette facilmente asportabili.

## Advantages

- » Self-levelling head that automatically justify slopes to 5%;
- » Adjustable height from 37,5 to 215mm once pavement is finished thanks to exclusive regulation key
- » 320 cm<sup>2</sup> smooth base support
- » Entirely recyclable
- » Resistant to temperatures between -40° to 120°C
- » Resistant to acids and ultraviolet deterioration
- » Suitable to any self-supporting outdoor paving system
- » Protect by international PATENT
- » Head with upper part of soft non-slip and anti-noise rubber

Codice Code	Misura Size	Prezzo Price	imb.	u.m.	peso / weight Kg.
SRA0038X	28-38 mm	7,80	1	pz	0,270
SRA0050X	37,5-50 mm	8,20	1	pz	0,340
SRA0075X	50-75 mm	8,70	1	pz	0,380
SRA0120X	75-120 mm	9,60	1	pz	0,490
SRA0170X	120-170 mm	10,20	1	pz	0,560
SRA0215X	170-215 mm	10,50	1	pz	0,648
CHIAVE1X	Chiave di Regolazione - Adjustment key	76,00	1	pz	0,120



- Chiave di regolazione rinforzata. Utilizzabile solo con aletta 4 mm.  
*Reinforced adjustment key. Suitable only with standard 4 mm thick tabs.*
- Alette preincise per una facile asportazione / *Pre-cut tabs for easy removal*
- Testa autolivellante in bi-materiale PP+gomma anti-rumore e anti-scivolamento  
*Bi-material self-levelling head PP + rubber anti-noise and anti-slip*
- Aggancio testa-vite: la testa sempre in sede! / *Coupling head to screw attachment system*

5 Vite / Screw

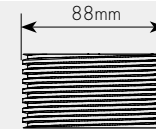

6 Sistema di blocco dei componenti / *Block System*

7 Fori scarico acqua / *Water drainage holes*

8 Base di appoggio  
*Supporting base*

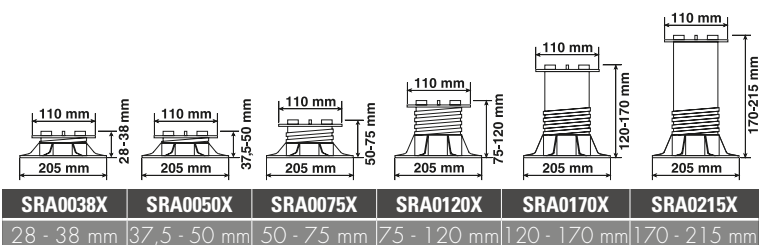
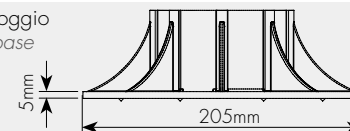

# SRF SUPPORTO REGOLABILE CON TESTA IN BIMATERIALE (PP+GOMMA)

ADJUSTABLE PAVING SUPPORT WITH BI-MATERIAL HEAD

## Vantaggi

- » Regolazione millimetrica da 25 a 270 mm;
- » Regolazione dell'altezza, a pavimento finito, grazie all'esclusiva chiave di regolazione;
- » Testa con parte superiore in gomma antirumore ed antiscivolamento;
- » Base di appoggio liscia di 320 cm<sup>2</sup>;
- » Resistente agli agenti atmosferici, agli acidi, all'invecchiamento, ai raggi UV;
- » Resistente a temperature fra -40° e +120°C;
- » Totalmente riciclabile;
- » Utilizzabile con qualsiasi pavimentazione da esterno;
- » Alette facilmente asportabili.



## Advantages

- » Precision adjustment from 25 to 270 mm
- » Possibility of adjusting the height once the floor has been finished, thanks to the exclusive adjustment wrench
- » End with upper part in noise-reducing anti-slip rubber
- » Smooth support base of 320 cm<sup>2</sup>
- » Resistant to weathering, acids, UV rays and wear and tear.
- » Resistant to temperatures ranging from -40 °C to +120°C.
- » Fully recyclable
- » Can be used in conjunction with any outdoor flooring

Codice Code	Misura Size	Prezzo Price	imb.	u.m.	peso / weight Kg.
SRF0040X	25-40 mm	4,70	1	pz	0,243
SRF0070X	40-70 mm	5,30	1	pz	0,308
SRF0100X	60-100 mm	6,00	1	pz	0,379
SRF0160X	90-160 mm	7,50	1	pz	0,402
SRF0270X	150-270 mm	10,30	1	pz	0,666
CHIAVE1X	Chiave di Regolazione - Adjustment key	76,00	1	pz	0,120

- 1 Chiave di regolazione rinforzata / Reinforced adjustment key
- 2 Alette preincise per una facile asportazione / Pre-cut tabs for easy removal
- 3 Testa autolivellante in bi-materiale PP+gomma anti-rumore e anti-scivolamento / Bi-material self-levelling head PP + rubber anti-noise and anti-slip
- 4 Aggancio testa-vite: la testa sempre in sede! / Coupling head to screw attachment system

- 5 Vite / Screw



- 6 Sistema di blocco dei componenti / Block System
- 7 Fori scarico acqua / Water drainage holes

- 8 Base di appoggio / Supporting base

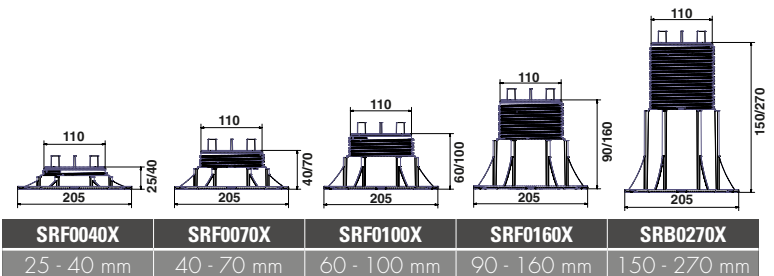
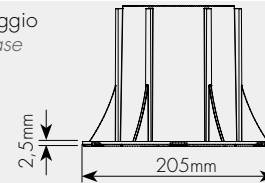

# SRB BASIC SUPPORTO REGOLABILE

ADJUSTABLE PAVING SUPPORT

## Vantaggi

- » Regolazione millimetrica da 27 a 120 mm
- » Regolazione dell'altezza agendo direttamente sulla base
- » Base di appoggio liscia di 320 cm<sup>2</sup>
- » Resistente agli agenti atmosferici, agli acidi, all'invecchiamento, ai raggi UV
- » Resistente a temperature fra -40° e +120°C
- » Totalmente riciclabile
- » Utilizzabile con qualsiasi pavimentazione da esterno

## Advantages

- » Precision adjustment from 27 to 120 mm
- » Possibility of adjusting the height by acting directly upon the base
- » Smooth support base of 320 cm<sup>2</sup>
- » Resistant to weathering, acids, UV rays and wear and tear
- » Resistant to temperatures ranging from -40 °C to +120°C
- » Fully recyclable
- » Can be used in conjunction with any outdoor flooring

Codice Code	Misura Size	Prezzo Price	imb.	u.m.	peso / weight Kg.
SRB0035X	27-35 mm	4,20	1	pz	0,200
SRB0050X	35-50 mm	4,40	1	pz	0,210
SRB0080X	50-80 mm	4,90	1	pz	0,228
SRB0120X	70-120 mm	5,30	1	pz	0,280



- 1** Testa/vite con alette standard spessore 4 mm, H12mm, su richiesta:
- testa liscia
  - Alette spessore 2 mm - H10 mm
  - Alette spessore 3,5 mm - H18 mm

Head/screw with standard 4 mm thick tabs, H12mm. On request:

- flat head
- 2 mm thick tabs - H10 mm
- 3,5 mm thick tabs - H18 mm

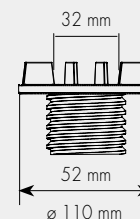

- 2** Alette preincise per una facile asportazione / Pre-cut tabs for easy removal

- 3** Base di appoggio  
Supporting base

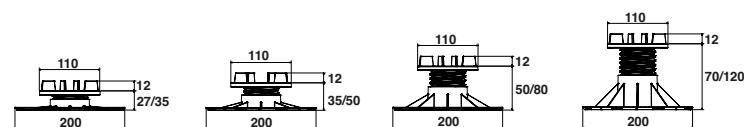
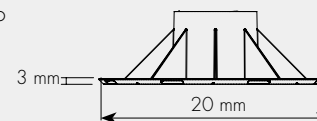

SRB0035X	SRB0050X	SRB0080X	SRB0120X
27 - 35 mm	35 - 50 mm	50 - 80 mm	70 - 120 mm

# SISTEMA AUTOLIVELLANTE

## SELF-LEVELING SYSTEM

L'auto-livellamento permette di compensare automaticamente pendenze fino al 5%.  
The self-levelling stand allows it to automatically compensate any gradient up to 5%.

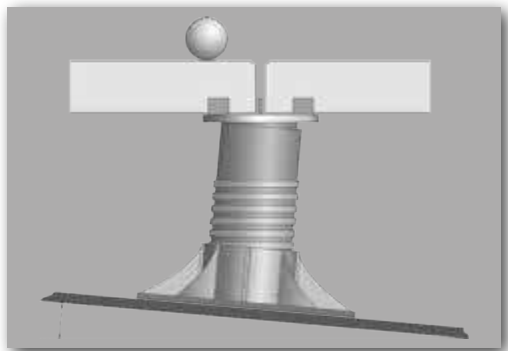

## CONSUMO E DETTAGLI SULLA POSA

### USAGE DATA AND INSTALLATION DETAILS

#### Calcolo per il consumo per m<sup>2</sup>

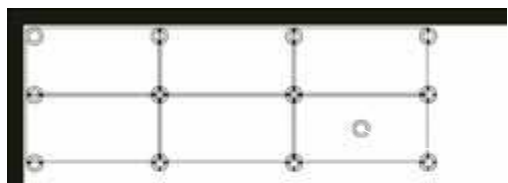

#### POSA LINEARE

PIASTRA 40 cm x 80 cm  
mt 0,4 x mt 0,8 = 0,32  
 $1 \text{ (m}^2\text{)} / 0,32 = 3,12 \text{ pz/m}^2$

#### LINEAR LAYING

TILES 40 cm x 80 cm  
mt 0,4 x mt 0,8 = 0,32  
 $1 \text{ (m}^2\text{)} / 0,32 = 3,12 \text{ pz/m}^2$

Si consiglia l'uso di un supporto extra da posizionare al centro della piastra stessa.  
It is recommended that an extra paving support should be placed in the centre of the tile.

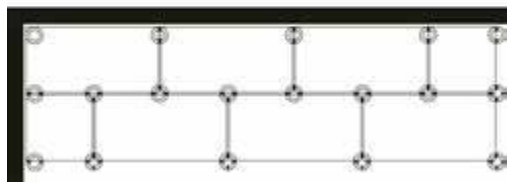

#### POSA ALTERNATA

PIASTRA 40 cm x 80 cm  
mt 0,4 x mt 0,8 = 0,32  
 $1 \text{ (m}^2\text{)} / 0,32 \times 2 = 6,24 \text{ pz/m}^2$

#### ALTERNATE LAYING

TILES 40 cm x 80 cm  
mt 0,4 x mt 0,8 = 0,32  
 $1 \text{ (m}^2\text{)} / 0,32 \times 2 = 6,24 \text{ pz/m}^2$

Centro pavimento  
In the middle



Bordo muro  
Along the wall



Angolo muro  
At the corner



N.B. Il calcolo non tiene in considerazione dello sfido generato dal perimetro.  
N.B.: The calculation does not take into consideration the waste generated by the perimeter.

# CARATTERISTICHE TECNICHE

## TECHNICAL CHARACTERISTIC

### LE NORME ISO

QUESTE NORME, ELABORATE DALL'ISO TC 189, SOSTITUISCONO IN ITALIA, E NEI PAESI CHE LE HANNO RICONOSCIUTE, QUELLE PRECEDENTEMENTE ESISTENTI (EN).

Definiscono i criteri di campionamento, controllo ed accettazione di tutte le piastrelle di ceramica: pressate, estruse o realizzate mediante altri processi, smaltate e non smaltate e di qualunque formato.

Le norme ISO della serie 10545 definiscono il procedimento per campionare le piastrelle che dovranno essere sottoposte a prova (ISO 10545.1) ed i metodi di prova per verificare la qualità delle piastrelle, mediante la determinazione delle caratteristiche d'aspetto, dimensionali e delle proprietà chimiche e fisiche (ISO 10545.2 - 16).

Gli standard relativi al prodotto, in cui sono contenuti i limiti di accettabilità che definiscono i materiali di prima scelta, sono invece stati raccolti nelle norme della serie ISO 13006. Sono stati definiti 11 allegati che identificano i vari prodotti ceramici, suddividendoli in relazione al grado di assorbimento d'acqua ed alla formatura.

Con la lettera A sono ancora definite le piastrelle estruse. Con la lettera B quelle pressate a secco le quali, in funzione dell'assorbimento d'acqua, sono così ulteriormente divise. Nell'approvarle in Europa il CEN le ha raggruppate in un'unica norma, la EN 14411:2012, che con i diversi allegati copre tutti i capitoli ed i contenuti delle norme ISO.

### THE ISO STANDARDS

THESE STANDARDS, DRAWN UP BY THE ISO TC189, REPLACE THE PREVIOUS (EN) STANDARDS IN ITALY AND IN THE OTHER COUNTRIES THEY ARE RECOGNIZED.

They outline the sampling, checking and acceptance criteria to apply to all ceramic tiles, whether pressed, extruded or produced with other processes, glazed or unglazed and whatever the format. The ISO 10545 series standards establish the procedure for sampling tiles to undergo testing (ISO 10545.1) and the testing methods to check the tile quality, by determining the aspects of appearance, size and chemical and physical properties (ISO 10545.2 - 16).

The standards relating to the product, on the other hand (which include the limits of acceptability used to determine the first class material), are grouped together in the ISO 13006 series standards. 11 annexes have been established which identify the various ceramic products, subdividing them according to water absorption and moulding.

The letter A is still used to identify the extruded tiles and the letter B is used to identify the dry pressed tiles.

These letters are then divided up further according to their water absorption rate as follows: When approving them in Europe the CEN grouped them into a single standard, the EN 14411:2012, which covers all the sections and contents of the ISO standards in its annexes.

ALLEGATO ANNEX	GRUPPO GROUP	ASSORBIMENTO D'ACQUA (E) WATER ABSORPTION (E)
G	Bla	$E \leq 0,5\%$
H	B1b	$0,5\% < E \leq 3\%$
I	B11a	$3\% < E \leq 6\%$
J	B11b	$6\% < E \leq 10\%$
K	B111	$E > 10\%$

**GRES PORCELLANATO / PORCELAIN STONEWARE**

 CLASSIFICAZIONE SECONDO NORME UNI EN 14411 (ISO 13006) ALLEGATO G-Gruppo B1a  
 CLASSIFICATION IN ACCORDANCE WITH UNI EN 14411 (ISO 13006) ANNEX G-Group B1a

PROPRIETÀ FISICO-CHIMICHE PHYSICAL-CHEMICAL PROPERTIES	NORMA NORM	VALORE PRESCRITTO DALLE NORME VALUE PRESCRIBED FROM THE NORMS	VALORE ABK VALUE ABK
LUNGHEZZA E LARGHEZZA DIMENSIONE MEDIA DI OGNI PIASTRELLA LENGTH AND WIDTH OF THE AVERAGE-SIZES TILE	UNI EN ISO 10545/2	± 0,5%	CONFORME ACCORDING
SPESSORE THICKNESS	UNI EN ISO 10545/2	± 5%	CONFORME ACCORDING
RETTILINEARITÀ SPIGOLI WARPAGES OF EDGES	UNI EN ISO 10545/2	± 0,5%	CONFORME ACCORDING
ORTOGONALITÀ WEDGING	UNI EN ISO 10545/2	± 0,6%	CONFORME ACCORDING
PLANARITÀ FLATNESS	UNI EN ISO 10545/2	± 0,5%	CONFORME ACCORDING
ASSORBIMENTO D'ACQUA WATER ABSORPTION	UNI EN ISO 10545/3	$E \leq 0,5\%$	CONFORME ACCORDING
RESISTENZA ALLA FLESSIONE BENDING STRENGTH	UNI EN ISO 10545/4	$\geq 35 \text{ N/mm}^2$	CONFORME ACCORDING
FORZA DI ROTTURA BREAKING STRENGTH	UNI EN ISO 10545/4	$\geq 1300 \text{ N}$	CONFORME ACCORDING
RESISTENZA ALL'ABRASIONE SUPERFICIALE PER PIASTRELLE SMALTATE ABRASION RESISTANCE FOR GLAZED TILES	UNI EN ISO 10545/7	IN FUNZIONE DELLA DESTINAZIONE D'USO ACCORDING TO THE DESTINATION OF FINAL USE	VEDI COLLEZIONE SEE COLLECTION
RESISTENZA AGLI SBALZI TERMICI THERMAL SHOCK RESISTANCE	UNI EN ISO 10545/9	RICHIESTA REQUIRED	RESISTE RESISTS
RESISTENZA AL GELO FROST RESISTANCE	UNI EN ISO 10545/12	RICHIESTA REQUIRED	INGELIVO FROST PROOF
RESISTENZA ALL'ATTACCO CHIMICO CHEMICAL RESISTANCE	UNI EN ISO 10545/13	-	RESISTE RESISTS
RESISTENZA ALLE MACCHIE RESISTANCE TO STAINING	UNI EN ISO 10545/14	GL $\geq$ MINIMO CLASSE 3	RESISTE RESISTS
COEFFICIENTE D'ATTRITO DINAMICO DYNAMIC FRICTION COEFFICIENT	B.C.R.A. C.A.	$\mu < 0,19$ SCIVOLOSITÀ PERICOLOSA - DANGEROUSLY SLIPPERY $0,20 < \mu < 0,39$ SCIVOLOSITÀ ECCESSIVA - EXCESSIVELY SLIPPERY $0,40 < \mu < 0,74$ ATTRITO SODDISFACENTE - SATISFACTORY GRIP $\mu > 0,75$ ATTRITO ECCELLENTE - EXCELLENT GRIP	VEDI COLLEZIONE SEE COLLECTION
	B.C.R.A. G.B.		
COEFFICIENTE D'ATTRITO STATICO COEFFICIENT OF STATIC FRICTION	ASTM C 1028 (S.C.O.F.)	SLIP RESISTANT ( $> 0,60$ )	VEDI COLLEZIONE SEE COLLECTION
CLASSIFICAZIONE ANTISDRUCCIOLO NON-SLIP CLASSIFICATION	DIN 51130	IN FUNZIONE DELL'AMBIENTE O DELLA ZONA DI LAVORO BASING ON THE ENVIRONMENT OR THE WORKING AREA	VEDI COLLEZIONE SEE COLLECTION
RESISTENZA ALLO SCIOLAMENTO SLIP RESISTANCE	DIN 51097	-	VEDI COLLEZIONE SEE COLLECTION

 VARIAZIONE CROMATICA  
SHADE VARIATION

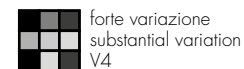
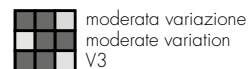
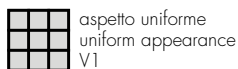
 VEDI COLLEZIONE  
SEE COLLECTION



## CARATTERISTICHE TECNICHE / TECHNICAL CHARACTERISTIC

### BICOTTURA / DOUBLE-FIRED WALL TILES

CLASSIFICAZIONE SECONDO NORME UNI EN 14411 (ISO 13006) Gruppo Blll  
CLASSIFICATION IN ACCORDANCE WITH UNI EN 14411 (ISO 13006) Group Blll

PROPRIETÀ FISICO-CHIMICHE PHYSICAL-CHEMICAL PROPERTIES	NORMA NORM	VALORE PRESCRITTO DALLE NORME VALUE PRESCRIBED FROM THE NORMS	VALORE ABK VALUE ABK
LUNGHEZZA E LARGHEZZA DIMENSIONE MEDIA DI OGNI PIASTRELLA LENGTH AND WIDTH OF THE AVERAGE-SIZES TILE	UNI EN ISO 10545/2	$l \leq 12 \text{ cm: } \pm 0,5\%$	CONFORME ACCORDING
		$l > 12 \text{ cm: } \pm 0,3\%$	
SPESSORE THICKNESS	UNI EN ISO 10545/2	$\pm 10\%$	CONFORME ACCORDING
RETTILINEARITÀ SPIGOLI WARPAGES OF EDGES	UNI EN ISO 10545/2	$\pm 0,3\%$	CONFORME ACCORDING
ORTOGONALITÀ WEDGING	UNI EN ISO 10545/2	$\pm 0,5\%$	CONFORME ACCORDING
PLANARITÀ FLATNESS	UNI EN ISO 10545/2	+ 0,5% - 0,3%	CONFORME ACCORDING
ASSORBIMENTO D'ACQUA WATER ABSORPTION	UNI EN ISO 10545/3	> 10%	CONFORME ACCORDING
RESISTENZA ALLA FLESSIONE BENDING STRENGTH	UNI EN ISO 10545/4	per spessore $\geq 7,5 \text{ mm}$ >15 N/mm <sup>2</sup>	CONFORME ACCORDING
		per spessore < 7,5 mm >12 N/mm <sup>2</sup>	
RESISTENZA AGLI SBALZI TERMICI THERMAL SHOCK RESISTANCE	UNI EN ISO 10545/9	RICHIESTA REQUIRED	RESISTE RESISTS
RESISTENZA ALLE MACCHIE RESISTANCE TO STAINING	UNI EN ISO 10545/14	CLASSE 3 MINIMO CLASS 3 MINIMUM	CLASSE 4 MIN CLASS 4 MIN

### MONOCOTTURA DA RIVESTIMENTO / SINGLE-FIRED WALL TILES

CLASSIFICAZIONE SECONDO NORME UNI EN 14411 (ISO 13006) Gruppo Bllb  
CLASSIFICATION IN ACCORDANCE WITH UNI EN 14411 (ISO 13006) Group Bllb

PROPRIETÀ FISICO-CHIMICHE PHYSICAL-CHEMICAL PROPERTIES	NORMA NORM	VALORE PRESCRITTO DALLE NORME VALUE PRESCRIBED FROM THE NORMS	VALORE ABK VALUE ABK
LUNGHEZZA E LARGHEZZA DIMENSIONE MEDIA DI OGNI PIASTRELLA LENGTH AND WIDTH OF THE AVERAGE-SIZES TILE	UNI EN ISO 10545/2	$\pm 0,5\%$	CONFORME ACCORDING
SPESSORE THICKNESS	UNI EN ISO 10545/2	formato 10x10 $\pm 10\%$	CONFORME ACCORDING
RETTILINEARITÀ SPIGOLI WARPAGES OF EDGES	UNI EN ISO 10545/2	$\pm 0,5\%$	CONFORME ACCORDING
ORTOGONALITÀ WEDGING	UNI EN ISO 10545/2	$\pm 0,6\%$	CONFORME ACCORDING
PLANARITÀ FLATNESS	UNI EN ISO 10545/2	+ 0,5%	CONFORME ACCORDING
ASSORBIMENTO D'ACQUA WATER ABSORPTION	UNI EN ISO 10545/3	$6\% < E \leq 10\%$	CONFORME ACCORDING
RESISTENZA ALLA FLESSIONE BENDING STRENGTH	UNI EN ISO 10545/4	>18 N/mm <sup>2</sup>	CONFORME ACCORDING
RESISTENZA AGLI SBALZI TERMICI THERMAL SHOCK RESISTANCE	UNI EN ISO 10545/9	RICHIESTA REQUIRED	RESISTE RESISTS
CESSIONE DI PIOMBO Pb LEAD RELEASE	UNI EN ISO 10545/15	-	NPD*
CESSIONE DI CADMIO Cd CADMIUM RELEASE	UNI EN ISO 10545/15	-	NPD*

\* I dati relativi alla norma verranno forniti su richiesta in base alla destinazione d'uso. / The test data can be supplied according to the destination of final use.

UNA NUOVA  
CONCEZIONE DEL  
RIVESTIMENTO  
CERAMICO.  
WALL & PORCELAIN.

ABK Group ha pensato a una nuova idea di rivestimento in porcellanato, considerato come un elemento a se stante dal quale scegliere diverse tipologie stilistiche: dallo stile neutro alle campiture piene, dai mosaici lisci ai muretti tridimensionali, all'iperdecorativo con progettazioni di decorazioni a grande dimensione.

WALL&PORCELAIN coniuga le migliori caratteristiche del porcellanato quali resistenza, carico di rottura, grandi formati con le più funzionali caratteristiche dei prodotti da rivestimento come peso, facilità di posa e di lavorazione. E' ideale come complemento da abbinare alle diverse tipologie estetiche di pavimenti in gres porcellanato tradizionale.

A NEW CONCEPT IN CERAMIC WALL  
COVERINGS.  
WALL & PORCELAIN.

ABK Group has created a new kind of covering in porcelain stoneware, seen as an interior design element in its own right, with a vast range of styles to choose from: from neutral styles to solid surfaces, from smooth mosaics to three-dimensional walls, and ultra-ornate solutions with big, bold decorative motifs.

WALL&PORCELAIN combines the best characteristics of porcelain stoneware, namely strength, ultimate tensile stress and large sizes with the most functional aspects of traditional wall tiles, namely light weight, ease of installation and workability. It is ideal for use in conjunction with the various styles of floor in traditional porcelain stoneware.

# WALL&PORCELAIN

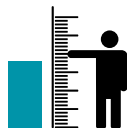

Piastrelle di grande formato,  
tutte con bordo RETTIFICATO.

Tiles with large size, all with  
RECTIFIED edges.



MINORE peso e spessore per  
ridurre le problematiche di  
trasporto.

REDUCED weight and thickness to  
decrease transport problems.



ELIMINAZIONE dell'eventuale  
problema del cavillo tardivo  
post posa e GARANZIA di  
perfetta planarità.

ELIMINATION of the after-laying  
quibble and GUARANTEE of  
perfect planarity.



FACILITÀ di posa per  
maneggevolezza e MAGGIORE  
lavorabilità del prodotto per il  
posatore.

EASY to lay and handle and  
EASY-TO-WORK by the fitter.



Tutti i prodotti sono rettificati a  
secco per RIDURRE l'impatto  
ambientale.

All products are dry rectified  
in order to REDUCE the  
environmental impact.



MAGGIORE isolamento termico  
ed acustico, le onde sonore sono  
assorbite e non rimbalzate.

IMPROVED thermal and acoustic  
insulation: sound waves are  
absorbed and do not bounce off.



MAGGIORE aderenza del  
prodotto alla superficie per le  
caratteristiche di elasticità del  
prodotto e per il peso.

SUPERIOR adherence of the  
product to the surface thanks to  
the product elasticity and weight.



Certificazione LEED per riduzione  
del consumo di materie prime  
naturali, riduzione del materiale  
da conferire in discarica, utilizzo  
di materiali derivanti da altre  
lavorazioni.

LEED certification for reduced  
consumption of natural raw  
materials, reduction of material  
to be dispatched to the landfill, use of  
recycled material resulting from other  
working processes.

## CONSIGLI PER LA POSA

La perfetta riuscita di una posa è dovuta, oltre alle qualità tecniche ed estetiche del materiale, ad un insieme di elementi (sottofondo, strato legante, giunti di dilatazione, ecc.) che costituiscono un vero e proprio sistema. Le operazioni di posa, eseguite nella loro corretta successione, sono da considerare importanti tanto quanto la scelta delle piastrelle. Nella scelta dell'adesivo più indicato e per le modalità di applicazione si consiglia di attenersi alle istruzioni dell'azienda produttrice del collante stesso. È importante, inoltre, controllare che i prodotti da utilizzare per la stuccatura, se molto colorati, non sporchino le superfici delle piastrelle e che tale sporco sia facile da asportare: si consiglia pertanto di effettuare una prova prima di dare inizio alla stuccatura. Il progetto di ogni superficie piastrellata deve essere affidato a un esperto progettista che, in funzione della struttura, della destinazione d'uso degli ambienti, dei carichi previsti e delle sollecitazioni meccaniche, termiche, fisiche e chimiche che graveranno sulla pavimentazione, deve dimensionare i sottofondi, strati cementizi, allestimento, piastrelle ceramiche, pendenza e tutto il sistema di posa. Inoltre, il progettista deve fissare nel capitolato di posa ogni specifica di cantiere, tra cui tipo e modalità di posa, materiali, granulometria, dosaggio, dimensioni delle fughe, giunti strutturali, di dilatazione, perimetrali, ecc.

## OPERAZIONI DI POSA

- 1) Scegliere accuratamente i requisiti estetici e tecnici delle piastrelle (in relazione allo stile e alla destinazione d'uso degli ambienti), i formati da posare, lo schema di posa, le dimensioni e il colore delle fughe.
- 2) Stendere a terra alcuni metri (almeno 3 mq) per controllare l'effetto d'insieme. Posare il materiale attingendo da più scatole controllandone accuratamente calibro, tonalità e scelta. Le variazioni cromatiche del prodotto sono una caratteristica qualificante che l'abilità del posatore può valorizzare. Un prodotto posato male non dà un buon risultato estetico.
- 3) Controllare i materiali prima della posa. Reclami su materiali già posati non saranno accettati.
- 4) La posa senza fuga è fortemente sconsigliata, l'alto grado di greificazione delle piastrelle di Abk comporta moderate tolleranze di calibro, pertanto, nella posa dei prodotti **non rettificati**, è consigliabile lasciare una **fuga almeno di 3 mm** fra le piastrelle.
- 5) Durante le operazioni di posa evitare di far coincidere i vertici di una piastrella con la metà delle altre a fianco. Soltanto i prodotti realizzati con tecnologia AUTO-LEVELING possono essere posati in qualsiasi modo.

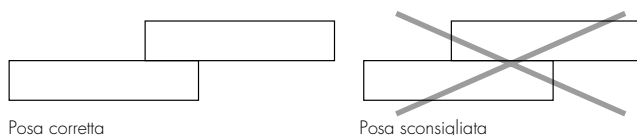

- 6) Eseguire la posa "a regola d'arte", seguendo le indicazioni del progettista, del responsabile di cantiere e del capitolato di posa. Per la migliore gestione del cantiere è fondamentale rispettare bene i tempi di lavorazione dei materiali utilizzati, seguendo le indicazioni dei produttori.
- 7) Non segnare la parte superiore con matite o pennarelli.
- 8) Attendere 48/72 ore prima di sottoporre il pavimento al normale transito.
- 9) Dedicare particolare attenzione ai prodotti lucidi, lappati, levigati, che dovranno essere coperti durante i lavori di cantiere.

## CONSIGLI PER LA POSA DEL RETTIFICATO

La posa del prodotto **rettificato** a giunto accostato, non unito, richiede una maggiore attenzione e precisione da parte dell'installatore sia per quanto riguarda la planarità del piano di posa sia per la continuità delle fughe. Per un effetto ottimale della posa, Abk suggerisce di mantenere almeno **1 o 2 mm di fuga per una posa monoformato e 2 o 3 mm per combinare formati misti**. La posa a giunto unito, soprattutto nei grandi formati, è fortemente sconsigliata dai maggiori produttori di collante per i seguenti motivi:

- Difficoltà di assorbimento di eventuali movimenti strutturali in assenza di elementi comprimibili;
- Diverso comportamento dilatometrico fra piastrelle e massetto, in presenza di elevate escursioni termiche;
- Difficoltà di realizzo di una duratura ed efficace stuccatura.

Abk sconsiglia assolutamente pose senza fuga, per le quali si declina ogni responsabilità.

## STUCCATURA

- 1) Qualora non si utilizzasse la boiacca composta da cemento e sabbia, si consiglia di utilizzare colori di stucco su tono (possibilmente non utilizzare su materiali di colore chiaro stucchi di colore scuro, tipo nero, blu, rosso) e di verificare la compatibilità dei riempitivi per fughe con il prodotto ceramico.
- 2) Riempire le fughe con gli stucchi solo quando il pavimento è calpestabile, togliendo preventivamente dalle fughe ogni tipo di residuo.
- 3) Eseguire la stuccatura a "regola d'arte", seguendo le indicazioni del progettista, del responsabile di cantiere e del capitolato di posa.
- 4) Stuccare piccole superfici per volta (4/5 mq) e asportare le quantità eccedenti con spugne o stracci umidi (di sola acqua pulita).
- 5) Stucchi cementizi non additivati: seguire attentamente le indicazioni dei fabbricanti, a fine giornata pulire i residui di posa con spugna appena bagnata.
- 6) Stucchi epossidici o additivati (con lattici, ecc.): seguire attentamente le indicazioni dei fabbricanti, perché il loro rapido indurimento può richiedere pulizie molto laboriose, specialmente se la superficie delle piastrelle è anticivolo, ruvida o strutturata.

## LAVAGGIO DOPO LA POSA

Il lavaggio dopo la posa è una fase di fondamentale importanza per tutti gli interventi successivi e per la manutenzione. La pulizia di fine cantiere fatta con prodotti a base acida tamponati, quali ad esempio Deterdek di Fila, Keranet di Mapei, Della Plus di Kerakoll o Cement Remover di Faber, va eseguita una sola volta e presenta l'ulteriore vantaggio di conferire uniformità cromatica alla superficie. Con il lavaggio acido dopo la posa si eliminano i residui di posa e il normale sporco di cantiere come: malta, colla, pittura, sporco da cantiere di varia natura. È bene sapere che oltre il 90% delle contestazioni in cantiere è dovuto ad un cattivo, o addirittura inesistente, lavaggio con detergente acido dopo posa. Per evitare che un prodotto a base acida usato per la prima pulizia vada ad intaccare il riempimento a base cementizia delle fughe, è necessario, prima dell'operazione di pulizia, bagnare il pavimento affinché le fughe vengano impregnate e pertanto protette dall'azione corrosiva dell'acido stesso. È opportuno:

- Togliere con appositi detergenti a base alcalina sostanze grasse o simili
- Procedere al lavaggio dopo la posa
- Risciacquare abbondantemente il pavimento, raccogliendo l'acqua residua.
- La pulizia si esegue dopo 4-5 giorni dalla stuccatura (lo stucco deve indurire) e non oltre i 10 giorni, oltre questi tempi la pulizia può diventare molto più laboriosa; attenersi scrupolosamente ai consigli riportati dal produttore di detergenti. Fare sempre test preventivi (su una piastrella non posata), in particolare per prodotti lappati o levigati.

## INSTALLATION SUGGESTIONS

Other than the technical and aesthetic features of the material itself, state-of-the-art installation is a result of a series of other aspects (substrate, binding layer, expansion joints, etc.) that create a system. The installation procedures, carried out in the correct order, must be considered as much an influencing factor as the choice of ceramic tiles. When choosing the most suitable adhesive and installation method, it is necessary to follow the manufacturer's instructions. Moreover, it is recommended to pay particular attention, especially when using coloured grouting, to first check that they do not stain the ceramic surface or that the grout is not difficult to remove: it is recommended to carry out a test on a small portion of the surface before proceeding with grouting. The installation project of a surface must be supervised by an expert technician who, depending on the structure of the surface itself, on its destination of use and on the mechanical, thermal, physical and chemical stresses suffered from the surface, must then adapt substrates, cement layers, setting bed, ceramic tiles, inclination and the entire installation system as a whole. Moreover, the installation technician must state every single detail of the project in the technical specifications, for example the installation pattern, the material, granulometry, dosage, grout line dimension, structural joints, perimeter joints, etc.

## INSTALLATION PROCEDURES

- 1) Carefully choose the technical and aesthetic features of the ceramic tiles (depending on the destination of use and characteristics of the surface), their sizes, the installation pattern, the dimension and colour of grout lines.
- 2) Place some of the chosen tiles (at least 3 square meters) onto the surface to check the final effect before proceeding. When installing the tiles, pick them from different boxes and check their work-size, their shade and sorting grade. Variations in colour shadings represent an added value of the product that can be enhanced by the skill of an expert fitter. A product that is not correctly laid does not produce a good aesthetic result.
- 3) Check ceramic tiles before starting installation. This is because, once installed, any complaints relating to already installed tiles will be rejected.
- 4) Jointless installation is not recommended, as the high level of verification of Ceramic ABK tiles leads to moderate work-size tolerances, therefore when laying **non straight-edged products**, it is recommended to allow **at least a 3mm grout line** between adjacent tiles.
- 5) Do not lay large sizes in a brick pattern. To this end a mm joint is recommended. Only the products produced with the AUTO-LEVELING technology can be laid in any way.

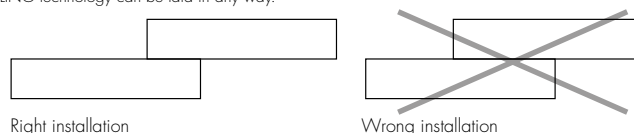

- 6) Carry out a state-of-the-art installation following the instructions of the technicians, of the building foreman and the technical specifications to the letter. In order to improve the works, it is of fundamental importance to respect the working times of the materials used, following the manufacturer's instructions.
- 7) Do not mark the front side of the tiles with pencils or felt-tip pens.
- 8) Wait 48-72 hours before using the floor.
- 9) Pay particular attention to glossy, honed, polished ceramic tiles that must be covered during building works.

## INSTALLATION SUGGESTIONS FOR RECTIFIED TILES

The installation of **rectified tiles** with minimum grout line (not with a jointless installation) requires particular attention and precision by the person laying the tiles, both in terms of planarity of the surface and of continuity of grout lines. For a perfect final result, Ceramic ABK recommends allowing at least a **1mm to 2mm grout line for the installation of ceramic tiles with the same size and at least 2mm to 3mm when installing tiles with different sizes**. Ceramic tile manufacturers do not recommend using minimum grout line installations for large size tiles, for the following reasons:

- Difficulty of tiles adapting to structural adjustments of the surface in absence of compressible elements;
- Different dilatometric behaviour between the tiles and the footing in case of thermal shocks;
- Difficulty in administering a correct and durable grouting.

Ceramic ABK strongly recommends to avoid using jointless installation patterns. In such cases, the company refutes all responsibility should problems arise.

## GROUTING

- 1) Should a grout made of cement and sand not be used, it is recommended to use shade-on-shade grouts (do not use dark grouts, such as black, blue or red, on bright materials) and to verify the compatibility of the grouts with the ceramic tile.
- 2) Fill the grout lines with the grout only when the floor has sufficiently set to be ready to tread on, removing any residue from the grout lines.
- 3) Carry out a state-of-the-art grouting following the layer and technician's instructions and the technical specifications.
- 4) Grout small areas of the surface at a time (4m<sup>2</sup> to 5m<sup>2</sup>) and remove excess grout with a sponge or a wet cloth (with clean water).
- 5) Non-added cement grouts: follow the manufacturer's instructions carefully and at the end of the working day clean the surface with a slightly damp sponge.
- 6) Epoxy grouts or added grouts (with latex, etc): follow the manufacturer's instructions to the letter as rapid hardening can lead to difficult cleaning operations, especially in case of anti-slip, rough or textured tiles.

## CLEANING AFTER INSTALLATION

The cleaning after installation is of fundamental importance for all the subsequent steps and for a correct maintenance. Post-installation cleaning using acid detergents with a padding action such as Fila Deterdek, Mapei Keranet, Kerakoll Della Plus or Faber Cement Remover must be carried out only once and only if this would result in the added bonus of giving the surface a more uniform aspect. Acid-cleaning will remove all residue associated with the installation and works in general, such as mortar, adhesive, paint and dirt. It is important to underline that 90% of complaints are due to a bad, or even nonexistent cleaning after installation. In order to make sure that an acid detergent used for the cleaning does not compromise the filling of grout lines, it is necessary, before proceeding with cleaning, to wet the floors so that the grout lines are impregnated and protected from the corrosive action of the acid. It is recommended to follow these steps:

- First, remove any grease or similar substance from the floor using alkaline detergents
- Proceed with the cleaning of the surface
- Rinse the floors with an abundance of water

The cleaning must be carried out 4-5 days after grouting (the grout must season) and within a maximum of 10 days after grouting, as, beyond this period of time the cleaning can be difficult, carefully follow the manufacturer's instructions for the use of detergents. It is always recommended to carry out a test on a sample tile (not installed), in particular in case of honed or polished products.

## MANUTENZIONE ORDINARIA

Si consiglia l'utilizzo di un comune detergente neutro diluito in acqua calda. Evitare l'utilizzo di prodotti acidi, alcalini, ceranti e/o impregnanti.

Nella pulizia ordinaria occorre limitare al massimo l'uso di mezzi abrasivi (ad esempio: paglietta di metallo, spugnette di ferro o acciaio). Questa precauzione diventa un obbligo nel caso di piastrelle con superficie lucida, più esposte ad effetti visibili di scalfiture, graffi...

In caso di sporchi più intensi o di superfici particolarmente strutturate, usare un detergente a base alcalina risciacquando al termine del lavaggio.

Nella pratica quotidiana occorre considerare che certi tipi di sporco (polvere, sabbia) aumentano l'effetto abrasivo del traffico pedonale. Cercare quindi di prevenire la presenza di questa tipologia di sporco dall'esterno, predisponendo l'utilizzo di zerbino o stuoino all'ingresso.

## RIMOZIONE DI PATINE LUCIDE

Nei normali detergenti in commercio sono a volte contenute cere o additivi lucidanti che, lavaggio dopo lavaggio, depositano sul pavimento patine lucide, causa di noiose alonature. Patine di questo tipo possono essere depositate anche da alcuni stucchi per le fughe. Semplici alimenti come Coca Cola, vino, acqua, etc., cadendo sul pavimento tolgono questa patina lucida e ripristinano l'aspetto originale più opaco delle piastrelle. In mezzo al pavimento più lucido, le zone senza cera appaiono come aloni opachi, in realtà sono le uniche parti pulite del pavimento.

In questi casi, dopo aver fatto un test preventivo, bisogna:

- Togliere la patina lucida da tutto il pavimento con un tipo di detergente a base alcalina.
- Utilizzare per le pulizie quotidiane, detergenti neutri che non contengono né cere né patine lucidanti.

## MANUTENZIONE STRAORDINARIA

Nel caso di tracce di sporco resistente alla pulizia ordinaria si raccomanda l'utilizzo di un detergente adeguato in funzione del tipo di sporco e comunque, prima dell'uso, fare sempre test preventivi su una piastrella non posata. Nella tabella "PRODOTTI PER LA PULIZIA E LA MANUTENZIONE" sono indicati i detergenti efficaci in funzione del tipo di macchia.

## PAVIMENTI E RIVESTIMENTI METALLIZZATI

Per la pulizia e manutenzione di piastrelle metallizzate si raccomanda di non usare assolutamente detergenti acidi o alcalini. Usare esclusivamente prodotti con PH neutro come ad esempio Fila Cleaner o Floor Cleaner di Faber. In ogni caso verificare sempre prima il prodotto su una porzione di materiale non posato ed evitare di lasciare il detergente sulle piastrelle per più di 10-15 min. Risciacquare sempre abbondantemente con acqua.

## TRATTAMENTO PRODOTTI LAPPATI E LEVIGATI

Lappatura e levigatura sono lavorazioni che prevedono sempre l'asportazione di una parte superficiale dello smalto o del corpo stesso della piastrella. In tutti i pavimenti ceramici disponibili sul mercato, tale lavorazione, pur in presenza di materiali vetrosi o a bassissimo assorbimento, può comportare l'apertura di microporosità superficiali che a contatto con particolari tipi di sporco, possono risultare di difficile pulizia o presentare aloni difficilmente rimuovibili.

Dopo il lavaggio di post-posa Abk consiglia di procedere ad un trattamento antimacchia con prodotti certificati (marche raccomandate: Fila, Mapei, Kerakoll, Faber).

## RACCOMANDAZIONI

Ricordiamo di non usare mai detergenti a base di acido fluoridrico (HF) o dei suoi composti, compresi antrugine o smacchiatori di tipo spray che spesso lo contengono. Il danno che si potrà provocare sarà irreparabile in quanto non esiste pavimento sul mercato resistente a tale acido.

## AVVERTENZE

Le caratteristiche di pulizia dei materiali variano in modo significativo in funzione delle diverse modalità di installazione, condizioni d'uso, tipologie di superfici e ambiente. In linea generale all'aumentare delle caratteristiche di antiscivolo delle piastrelle, aumentano le difficoltà di pulizia. L'operatore professionale incaricato dell'intervento di manutenzione e pulizia, dovrà sempre procedere ad una preliminare verifica empirica, possibilmente su una porzione di materiale non posato, per ogni singolo tipo di intervento.

In caso di condizioni d'uso particolarmente gravose, di errata installazione o di pulizie effettuate in modo inadeguato Abk declina ogni responsabilità in merito all'efficacia delle operazioni di pulizia e manutenzione. Resta inteso che Abk non potrà essere ritenuta responsabile per eventuali danni o difetti dovuti ad errata installazione, negligente pulizia e manutenzione o inadeguata scelta della tipologia dei materiali installati e degli adesivi utilizzati con riguardo alla destinazione.

Le indicazioni contenute in questo paragrafo sono puramente indicative. Per notizie più approfondite rimandiamo a documentazione specializzata disponibile su cataloghi e siti web delle principali ditte produttrici di prodotti specifici per la pulizia dei pavimenti quali ad esempio:

Fila Industria Chimica S.p.A. [www.filachim.com](http://www.filachim.com)

Faber Chimica S.r.l. [www.faberchimica.com](http://www.faberchimica.com)

Mapei S.p.A. [www.mapei.it](http://www.mapei.it)

Kerakoll S.p.A. [www.kerakollgroup.com](http://www.kerakollgroup.com)

Bonasytems Italia S.r.l. [www.bonasytemsitalia.it](http://www.bonasytemsitalia.it)

## DAILY MAINTENANCE

It is recommended to clean the floor using a neutral detergent diluted in hot water. Avoid the use of acid, alkaline, waxing and/or impregnating products.

During ordinary cleaning procedures, it is recommended to limit the use of abrasive means such as scouring pads, iron and/or steel sponges. Taking this precaution is a must on glossy tiles, as they are more liable to scratching.

In case of intense dirt or textured surfaces, use an alkaline detergent, rinsing the floor with an abundance of water.

It is important to underline that certain types of dirt like dust or sand, increase the abrasive effect of foot traffic on the surface. The use of a door mat at the entrance can help prevent this.

## REMOVAL OF FILMS ON THE FLOOR

The standard detergents available on the market sometimes contain waxes or polishing additives that, cleaning after cleaning, create a film on the floor and cause rims. This type of film can also develop when using certain types of grouts. Everyday stains on the floor, such as cola, wine, water, etc. remove this film and reveal the original, more opaque aspect of the tiled surface. On a glossy floor, these areas with no wax appear as rims but, in actual fact, they are the only clean areas of the floor itself.

In such cases, after having carried out a test, it is necessary to:

Remove the film from the floor using an alkaline detergent.

Use neutral detergents, which do not contain wax or polishing additives for everyday cleaning.

## EXTRAORDINARY MAINTENANCE

In case of stains that are resistant to standard cleaning operations, it is recommended to use a specific detergent depending on the type of dirt and, every single time before using such detergent, to carry out a test on a non-installed sample tile. The chart "REMOVE STAINS" indicates the recommended detergents that are effective for certain specific stains.

## METALLISED FLOOR AND WALL COVERINGS

For the cleaning and maintenance of metallised tiles, it is recommended not to use acid or alkaline detergents. Use products with neutral PH such as Fila Cleaner or Faber Floor Cleaner. Every single time, test the product on a sample tile that has not been installed and do not leave the detergent on the tiles for more than 10-15 minutes. Always rinse the surface with an abundance of water.

## TREATMENT OF HONED AND POLISHED TILES

Honing and polishing are manufacturing processes that always remove a superficial part of the glaze or of the body of the tile itself. All honed and/or polished ceramic tiles available on the market have a micro-porous structure that, even when using low absorption vitreous materials, are vulnerable to attack from certain types of dirt that can attack the micro-porous structure and make cleaning operations very difficult.

After post-installation cleaning using an acid detergent, Ceramiche ABK recommends an anti-stain treatment using specific products (suggested products: Fila, Mapei, Kerakoll, Faber).

## RECOMMENDATIONS

Never use hydrofluoric acid-based detergents or its derivatives, such as rust-preventing products or spray stain-removers that often contain hydrofluoric acid. The use of hydrofluoric acid will irreparably damage the surface, as no ceramic tile floor available on the market is resistant to this acid.

## WARNING

The cleaning features of materials considerably vary depending on the installation pattern, the conditions of use and the type of surface. As a general rule, as the anti-slip value of ceramic tile increases, the cleaning operations become more difficult. The professional technician in charge of the cleaning and maintenance must always carry out a preliminary test on a sample tile that has not been installed before proceeding with any cleaning operation.

In case of special conditions of use, incorrect installation or inadequate cleaning, Ceramiche ABK will not be responsible for the effectiveness of cleaning and maintenance procedures. It is agreed that ABK will not be responsible for any damage or defects that are due to incorrect installation, cleaning and maintenance or due to a wrong choice of materials and adhesives.

The above-stated instructions are merely indicative. For in-depth information, please consult the specific documents that are available on the catalogues and website of the manufacturers of detergents for ceramic floors, in particular:

Fila Industria Chimica S.p.A. ( [HYPERLINK "http://www.filachim.com"](http://www.filachim.com) [www.filachim.com](http://www.filachim.com)).

Faber Chimica S.r.l. ( [HYPERLINK "http://www.faberchimica.com"](http://www.faberchimica.com) [www.faberchimica.com](http://www.faberchimica.com)).

Mapei S.p.A. ( [HYPERLINK "http://www.mapei.it"](http://www.mapei.it) [www.mapei.it](http://www.mapei.it)).

Kerakoll S.p.A. ( [HYPERLINK "http://www.kerakollgroup.com"](http://www.kerakollgroup.com) [www.kerakollgroup.com](http://www.kerakollgroup.com)).

PRODOTTI PER LA PULIZIA E LA MANUTENZIONE  
CLEANING AND MAINTENANCE PRODUCTS

TIPO DI MACCHIA TYPE OF STAIN		DETERGENTE CONSIGLIATO DETERGENT	
MACCHIE INORGANICHE INORGANIC STAINS	CALCARE LIME	ACIDA ACID	DETERDEK (FILA) - CEMENT REMOVER (FABER) - BONACLEAN (BONASYSTEMS)
	CEMENTO - SALNITRO CEMENT - SALTPETRE		DETERDEK (FILA) - CEMENT REMOVER (FABER) - BONACLEAN (BONASYSTEMS)
	DEPOSITI CALCAREI DEPOSITS OF LIME		VIAKAL - BONACLEAN (BONASYSTEMS)
	RUGGUNE RUST		DETERDEK (FILA) - CEMENT REMOVER (FABER) - BONACLEAN (BONASYSTEMS)
	SEGNI METALLICI METALLIC MARKS		DETERDEK (FILA) - BONACLEAN (BONASYSTEMS)
MACCHIE ORGANICHE ORGANIC STAINS	BIRRA BEER	ALCALINA ALKALINE	PS/87 (FILA) - WAX REMOVER (FABER) - BONADECAN (BONASYSTEMS)
	CAFFÈ COFFEE		PS/87 (FILA) - SR/95 (FILA) - WAX REMOVER (FABER) BONADECAN - BONAMAIN + (BONASYSTEMS)
	COLA COCA COLA		PS/87 (FILA) - SR/95 (FILA) - WAX REMOVER (FABER) - BONADECAN (BONASYSTEMS)
	MACCHIE VEGETALI VEGETABLE FAT		WAX REMOVER (FABER) - BONADECAN (BONASYSTEMS)
	OLIO E GRASSO OIL AND GREASE		PS/87 (FILA) - WAX REMOVER (FABER) - BONADECAN (BONASYSTEMS)
	PNEUMATICI TIRES		PS/87 (FILA) - POLISHING CREAM (FABER) BONADECAN - BONACLEAN + (BONASYSTEMS)
	TINTURA PER CAPELLI HAIR DYE		PS/87 (FILA) - SR/95 (FILA) - COLOURED STAIN REMOVER(FABER)
	GRASSI GLUE		PS/87 (FILA) - BONADECAN (BONASYSTEMS)
MACCHIE SINTETICHE SYNTHETIC STAINS	VINO WINE	SOLVENTE DISSOLVENT	PS/87 (FILA) - SR/95 (FILA) - OXIDANT (FABER) - BONADECAN (BONASYSTEMS)
	VERNICE PAINT		PS/87 (FILA) - NOPAINTSTAR (FILA) - BONADECAN - BONACLEAN + (BONASYSTEMS)
	BITUME BITUMEN		FILASOLV (FILA) - WAX REMOVER (FABER) - BONACLEAN (BONASYSTEMS)
	CERA DI CANDELA CANDLE WAX		FILASOLV (FILA) - WAX REMOVER (FABER) - BONADECAN (BONASYSTEMS)
	INCHIOSTRO INK		PS/87 (FILA) - SR/95 (FILA) - COLOURED STAIN REMOVER(FABER)
	PENNARELLO FELT-TIP PEN		PS/87 (FILA) - SR/95 (FILA) - COLOURED STAIN REMOVER(FABER)
ALONATURE RESIDUE RESIDUAL MARKS	RESIDUI DI SCOTCH REST OF STICKY TAPE	DETERGENTE DETERGENT	FILASOLV (FILA) - PS/87 (FILA) - SOLVENT STRIPPER (FABER) - BONADECAN (BONASYSTEMS)
	SPORCO DELLE FUGHE TILE JOINT STAINS		FUGANET (FILA) - BONACLEAN (BONASYSTEMS)
	ALONATURE VENTOSE STAINS FROM SUCTION CUPS		DETERDEK (FILA) + ALKALINE CLEANER (FABER) - BONADECAN (BONASYSTEMS)
	CERA PROTETTIVA PROTECTIVE WAX		DETERDEK (FILA)+FILASOLV (FILA) +SOLVENT STRIPPER (FABER) +WAX REMOVER (FABER) BONADECAN (BONASYSTEMS)

ATTENZIONE: I PRODOTTI A BASE ACIDA POSSONO CORRODERE MARMO, GRANITO, PIETRE NATURALI E METALLI, PERTANTO EVITARNE L'USO NEL CASO DI DECORI O INSERTI REALIZZATI CON QUESTI MATERIALI.  
IMPORTANT: ACID PRODUCTS MAY CORRODE MARBLE, GRANITE, NATURAL STONE AND METAL. AVOID USING IN THE PRESENCE OF DECORATION OR INSERTS IN THESE MATERIALS.

PER L'USO ATTENERSI SCRUPOLOSAMENTE ALLE INDICAZIONI RIPORTATE SULL'ETICHETTA.  
FOR THE CORRECT USE PLEASE FOLLOW THE INSTRUCTION MENTIONED ON THE LABEL.

LA RIPRODUZIONE DEI COLORI È APPROSSIMATIVA.  
COLOUR REPRODUCTION APPROXIMATE.

LE TABELLE CON I DATI RIFERITI AI CONTENUTI PER SCATOLE ED AI PESI DEGLI IMBALLI SONO AGGIORNATE AL MOMENTO DELLA STAMPA DEL CATALOGO, PERTANTO I DATI ELENCATI POSSONO SUBIRE VARIAZIONI.  
THE TABLES WITH THE DATA REFERRING TO BOX CONTENT AND PACKAGING WEIGHT HAVE BEEN UPDATED AT TIME OF PRINTING; THE ACTUAL DATA MAY BE SLIGHTLY DIFFERENT.





### PIASTRELLE PER PAVIMENTI

Floor tiles | Carregales pour sol  
Bodenfliesen | Baldosas para pavimentos  
НАПОЛЬНАЯ ПЛИТКА



### PIASTRELLE PER RIVESTIMENTI

Wall Tiles | Faiences  
Wandfliesen | Baldosas para revestimientos  
ОБЛИЦОВОЧНАЯ ПЛИТКА



### SPESSORE

Thickness | Epaisseur  
Stärke | Espesor  
ТОЛЩИНА



### RESISTENZA AL GELO

Frost resistance | Résistance au gel  
Frostbeständigkeit | Resistencia a la helada  
МОРОЗОСТОЙКОСТЬ



### RESISTENZA ALLO SCIVOLAMENTO

Skid resistance | Résistance à la glissance  
Rutschfestigkeitskoeffizient  
Resistencia al deslizamiento  
КОЭФФИЦИЕНТ СОПРОТИВЛЕНИЯ СКОЛЬЖЕНИЮ

DIN 51130  
DIN 51097  
ASTM C 1028  
B.C.R.A.



### GRES PORCELLANATO TUTTA MASSA

Full body porcelain | Grès cérame en pleine masse  
Vollgemischtes durchgefärbtes Feinsteinzeug  
Gres porcelánico toda masa  
КЕРАМОГРАНИТ, ОКРАШЕННЫЙ ПО ВСЕЙ ТОЛЩИНЕ



### RESISTENZA ALL'ABRASIONE PROFONDA

Resistance to deep abrasion | Résistance à l'abrasion profonde  
Widerstand gegen tiefenverschleiss  
Resistencia a la abrasión profunda  
СТОЙКОСТЬ К ГЛУБОКОМУ ИСТИРАНИЮ

ISO 10545.6



### TECNOLOGIA DIGITALE

Digital technology | Technologie numérique  
Digitaltechnik | Tecnología digital  
ЦИФРОВАЯ ТЕХНОЛОГИЯ

### VARIAZIONE CROMATICA

Colour shade variation | Variation de nuances  
Farbabweichung | Variación cromática  
ИЗМЕНЕНИЕ ЦВЕТА



### V1 ASPETTO UNIFORME

V1 uniform appearance | V1 aspect uniforme  
V1 einheitliche optik | V1 aspecto uniforme  
V1 ОДНОРОДНЫЙ ВИД



### V2 LIEVE VARIAZIONE

V2 minimal variation | V2 légère variation  
V2 leichte farbabweichung | V2 variación ligera  
V2 ЛЕГКОЕ ИЗМЕНЕНИЕ



### V3 MODERATA VARIAZIONE

V3 moderate variation | V3 variation modérée  
V3 mässige farbabweichung | V3 variación moderada  
V3 УМЕРЕННОЕ ИЗМЕНЕНИЕ



### V4 FORTE VARIAZIONE

V4 substantial variation | V4 effet dénuancé très accentué  
V4 starke farbabweichung | V4 variación evidente  
V4 СИЛЬНОЕ ИЗМЕНЕНИЕ



### PRODOTTI COMPOSTI DA ECO-BODY, IMPASTO STANDARD LEED

Products made with ECO-BODY, standard LEED dough  
Produits composés d'Eco-body, Pâte standard LEED  
ECO-BODY PRODUKT, aus Standard LEED Scherbe  
Productos conformes a estándar leed  
Материал изготовлен из экологической смеси,  
соответствует стандарту LEED

### RETT. RETTIFICATO

Rectified | Rectifié | Rechtwinklig | Rectificado  
КАЛИБРОВАННЫЙ

### LAPP. LAPPATO

Honed | Adduci | Halbpolierte | Recubierto  
ШЛИФОВАННЫЙ

La finitura lappata è sempre rettificata

The lapped finish is always rectified | La finition rodée est toujours rectifiée

Die geläppte Ausführung is immer geschliffen | El acabado pulido es siempre rectificado

Изделия со шлифованной отделкой, как правило, калиброваны

# CONDIZIONI GENERALI DI VENDITA

GENERAL SALES TERMS AND CONDITIONS

**1) APPROVAZIONE** Gli ordini pervenuti sono per noi impegnativi solo dopo la nostra conferma scritta.

**2) CONSEGNA** La consegna del materiale s'intende avvenuta a carico effettuato presso i nostri magazzini. Tutti i rischi di trasporto, compresi ammanchi, rotture, deterioramenti e manomissioni sono a carico del Committente anche se il prezzo pattuito è franco di porto, FOB o C&F. Gli accordi con spedizionieri s'intendono sempre conclusi in nome e per conto del Committente che fin d'ora ratifica ed accetta l'operato.

**3) TERMINI DI CONSEGNA** I termini di consegna hanno carattere indicativo, eventuali ritardi nelle consegne, interruzioni, sospensioni totali o parziali delle forniture non daranno diritto ad indennizzi o risarcimento danni.

**4) CONTESTAZIONI** La garanzia della merce è limitata al solo, ed esclusivamente, materiale di prima scelta, con una tolleranza del 5% circa. Le differenze di tonalità non potranno essere denunciate come vizio del materiale. Eventuali reclami in merito alla qualità, tipo del materiale, dovranno pervenirci entro 8 giorni dalla data di consegna. Il compratore s'impegna a tenere a disposizione le partite contestate così da consentire il controllo dei difetti denunciati, in ogni caso la posa in opera ci esonera da qualsiasi responsabilità. Eventuali vizi o difetti di qualità della merce, ove siano denunciati nei termini di legge ed accertati o riconosciuti, danno diritto solamente alla sostituzione dei materiali difettosi, a condizione della preventiva restituzione delle merci contestate, e, su autorizzazione scritta dell'operazione di resa, restando tassativamente esclusi la risoluzione del contratto e qualsiasi risarcimento danni.

**5) DIMENSIONI E TONALITA'** I nostri materiali sono da classificarsi fra i prodotti cotti ad alta temperatura e come tali possono presentare differenze tra le dimensioni dichiarate e quelle effettivamente consegnate. Così si dica per le differenze di tono all'interno della medesima partita. Quanto sopra perciò non potrà essere oggetto di reclamo da parte del committente.

**6) IMBALLO E QUANTITA'** Il buono stato degli imballi e della loro confezione nonché della quantità consegnata resta accertato con l'accettazione della merce da parte del vettore. Questi, firmando la Bolla di Accompagnamento, si rende responsabile del buono stato del materiale e del quantitativo. Il compratore nel caso si verificano rotture ed ammanchi dovrà chiedere eventuali danni o risarcimenti al vettore.

**7) RESI** Per nessuna ragione l'acquirente potrà restituire il materiale senza nostra espressa preventiva autorizzazione scritta e tutte le spese sono a carico del Committente.

**8) ANNULLI** Non verranno accettati annullamenti di ordini se il materiale è già stato prodotto o se è già stata avviata la lavorazione e molto più se è già stata effettuata la spedizione. L'annullamento dell'ordine comporterà in ogni caso l'obbligo da parte del Committente di pagare l'intera fornitura. Nel caso che sia fattibile l'accettazione dell'annullamento il Cliente sarà tassativamente tenuto a rifondere tutte le spese sostenute dal produttore fino a quel momento.

**9) PREZZI** I prezzi riportati sui nostri listini non sono per noi impegnativi. Ci riserviamo il diritto di modificarli prima dell'accettazione dell'ordine.

**10) PAGAMENTI** I pagamenti devono essere effettuati solo presso la nostra sede. Il ritardo di 10 giorni di ogni pagamento dovuto, o la mancata copertura nel termine stesso di un titolo di credito, girato o ceduto o emesso dal committente, costituisce grado di insolvenza. In tal caso sarà nostra facoltà sospendere le forniture ed annullare ogni rapporto in corso; immediatamente esigere l'integrale pagamento di ogni rapporto in corso; esigere l'integrale pagamento di ogni nostro credito ed agire giudizialmente al riguardo, in via esecutiva o cautelare nonché per il risarcimento danni; in ogni caso, trascorsi 10 giorni da ogni pagamento dovuto, siamo autorizzati a emettere tratta a vista con spese senza preavviso. Inoltre decorreranno sul debito scaduto gli interessi moratori annui calcolati nella misura del tasso "prime rate" corrente maggiorato di 5 punti percentuali.

**11) UNITÀ MINIMA DI VENDITA** Non si effettuano vendite inferiori alla scatola.

**12) COSTI IMBALLAGGI:** per tutti i prodotti di lunghezza 170 cm, come contributo fisso per imballo speciale, verrà addebitato un importo di 8 € a pallet.

**13) RISERVATO DOMINIO** Il materiale anche se spedito e regolarmente fatturato resta di nostra proprietà fino al pagamento totale della fornitura medesima anche in caso di passaggio o vendita terzi.

**14) FORO COMPETENTE** Per qualsiasi controversia sarà esclusivamente competente il foro di Modena.

## SERVIZI DI LOGISTICA

**ANNULLAMENTO ORDINI** per l'annullamento autorizzato di ordini di materiali già consegnati al nostro deposito e per resi autorizzati, verrà addebitato il 15% del valore imponibile, con fisso minimo di 20 €, per contributo spese di trasporto e rifezione.

**ORDINI MINIMI** per ordinativi limitati che sono a "completamento" od "evasioni singole" il cui valore imponibile è inferiore a 100 €, verrà applicata una maggiorazione di 20 € netta fissa.

**SPALLETTIZZATO** per ordini di metratura inferiore al pallet completo, verrà applicata una maggiorazione fissa di 1,50 € al mq.

**CONSEGNE URGENTI** per preparazione di ordini entro le 24 ore, con un limite massimo di 2 articoli totali, verrà addebitata una maggiorazione di 30 € netta fissa.



# GENERAL SALES TERMS AND CONDITIONS

- 1) **APPROVAL** All orders that we receive are considered to be binding only after our written confirmation has been issued.
- 2) **DELIVERY** The materials are intended as delivered upon loading at our warehouses. All transport risks, including missing pieces, breakage, deterioration and tampering are the sole responsibility of the Client, even if the price agreed upon is carriage free, FOB, or C&F. Agreements with forwarding agents are intended as concluded in the name of and on behalf of the Client, who hereby confirms and accepts their terms and conditions.
- 3) **TERMS OF DELIVERY** The terms of delivery are indicative, eventual delays in the delivery, interruptions, or total or partial suspensions of the supply do not allow any right to indemnification or compensation for damages.
- 4) **DISPUTES** The guarantee of the goods is limited only and exclusively to first rate materials, with a tolerance of approximately 5%. The difference in shades of colour cannot be declared as a material defect. Eventual complaints regarding the quality or the type of material must be submitted within 8 days from the date of delivery. The purchaser agrees to make available the disputed lots in order that the declared defects may be controlled. In any case, the installation exonerates the manufacturer from any liability. Eventual manufacturing defects or quality defects in the goods, where declared according to law and ascertained or recognized, give right only to the replacement of the defective materials, provided that the goods have been returned previously and the written authorization of the return operation has been issued, the resolution of the contract as well as any compensation for damages is peremptorily waived and excluded.
- 5) **DIMENSIONS AND TONALITY** Our materials are classified as products fired at high temperatures and as such may present discrepancies between the dimensions declared and those actually delivered. The same applies for differences in colours within the same production lot. Therefore, the client may not present a dispute regarding abovementioned product characteristic.
- 6) **PACKAGING AND QUANTITY** The good condition of the packaging and cartons as well as the quantity delivered are verified upon acceptance of the goods by the forwarding agent. The forwarding agent declares himself responsible for the condition and quality of the goods upon signing the packing list. In case of missing pieces of breakage, the purchaser must ask for eventual damages or compensation from the forwarding agent.
- 7) **RETURNS** For no reason will purchaser be able to return the material without our express prior written authorization and all the costs of the return will be assumed by the Client.
- 8) **CANCELLATIONS** Order cancellations will not be accepted if the material has already been produced or if the production has already begun, and more so if the materials have already been shipped. In any case, the Client is obliged to pay the entire sum of the supply if the order is cancelled. If the acceptance of the cancellation is feasible, the Client will be peremptorily obliged to reimburse all the expenses sustained by the producer up to that moment.
- 9) **PRICES** The prices on our price list are not binding. We reserve the right to modify prices before accepting an order.
- 10) **PAYMENT** Payments must be made only in our main office. Delays of more than 10 days for each payment due or insufficient funds during the same term of a check, whether endorsed or transferred, or issued by the customer, constitutes bad debt. In this case, we reserve the right to suspend supply and annual all ongoing relations, immediately require total payment of all ongoing relations; require total payment of each credit and to make legal recourse, whether executive or precautionary, as well as request compensation for damages. In any case, after 10 days any payment due, we are authorized to issue an on-sight draft with expenses without notice. Furthermore, annual penalty interest will accumulate on the expired debt to be calculated according to the current "Prime rate" plus five (%) percentage points.
- 11) **MINIMUM PACKAGING REQUIREMENTS** Sales of less than one box will not be allowed.
- 12) **PACKAGING COSTS** for all the products of length 170cm, as fix contribution for the special packaging, will be debt an amount of 8 € per pallet.
- 13) **SELLER'S LIEN** The material, even is shipped and regularly invoiced, remains our property until payment in full of the invoice itself, even in case of passage or sale to third parties.
- 14) **PLACE OF JURISDICTION** For any eventual dispute, the only place of jurisdiction will be the Modena Tribunal.

## GENERAL NOTE

**CANCELLATION OF ORDERS** for the authorized cancellation of orders for materials already delivered to our warehouse and for authorized returns of the goods, 1.5% of the taxable value will be charged, with a minimum fixed contribution of € 20 towards transport and reselection costs.

**MINIMUM ORDERS** for limited orders to complete a previous order or for single deliveries, with a taxable value of less than € 100, there is a fixed net surcharge of € 20.

**ORDERS FOR LESS THAN 1 PALLET** for orders of less than 1 complete pallet, will be charged a fixed amount of 1,50 €/m<sup>2</sup>

**URGENT DELIVERIES** for orders to be prepared within 24 hours, with a maximum quantity of 2 articles, there is a fixed net surcharge of € 30.

# CONDITIONS GÉNÉRALES DE VENTE

**1) ACCEPTATION** Les commandes parvenues ne seront valables de manière définitive qu'après confirmation écrite de notre part.

**2) LIVRAISON** La livraison du matériel est à considérer effectuée au moment du chargement dans nos entrepôts. Tous les risques de transport, tels que les manques, les casses, détériorations ou endommagements sont à la charge de l'Acheteur, même lorsque le prix convenu est franco, FOB ou C&F. Les accords conclus avec les transporteurs sont à considérer toujours au nom et pour compte de l'Acheteur, qui confirme et accepte les conditions au préalable.

**3) DÉLAIS DE LIVRAISON** Les délais de livraison ont un caractère indicatif; les éventuels retards de livraisons, interruptions, suspensions totales ou partielles des fournitures ne donneront droit à aucun dédommagement ou remboursement et intérêts.

**4) CONTESTATIONS** La garantie de la marchandise se limite seulement et exclusivement au matériel de premier choix, avec une marge de tolérance de 5% environ. Les différences de nuances ne pourront être dénoncées comme vice du matériel. Les éventuelles réclamations relatives à la qualité, au type de matériel, devront nous parvenir dans les 8 jours à partir du jour de livraison. L'Acheteur s'engage à mettre à disposition les parties contestées de manière à permettre le contrôle des défauts déclarés, sachant que la pose nous libère quoiqu'il en soit de toute responsabilité. Les éventuels vices ou défauts de qualité de la marchandise, si déclarés en vertu des termes de loi et confirmés ou reconnus, ne donnent droit qu'à la substitution des matériaux défectueux, à condition que les marchandises contestées ne soient rendues préalablement et, sur autorisation écrite de l'opération de restitution, en renonçant et en excluant ainsi de manière formelle la résolution du contrat tout comme les éventuels dommages et intérêts.

**5) DIMENSIONS ET TONS** Nos matériels se classent parmi les produits cuits à haute températures et peuvent présenter en tant que tels des différences entre les dimensions déclarées et celles effectivement livrées.

C'est ainsi que sont considérées les différences de tons à l'intérieur d'un même lot. C'est pourquoi, en vertu des conditions présentées précédemment, ceci ne pourra faire l'objet d'aucune réclamation de la part de l'Acheteur.

**6) EMBALLAGE ET QUANTITES** Le bon état des emballages et de leur confection, ainsi que de la quantité livrée est confirmé après acceptation de la marchandise de la part du transporteur. Ce dernier, en signant le Bon de Livraison, se tient responsable du bon état du matériel et de la quantité. En cas de casses ou manques, l'acheteur devra demander des éventuels dommages et intérêts ou dédommagements au transporteur.

**7) RESTITUTIONS** En aucun cas l'Acheteur ne pourra rendre le matériel sans préalablement recevoir une autorisation écrite de notre part et tous les frais sont à la charge de l'Acheteur.

**8) ANNULLATIONS** Aucune annulation de commandes ne sera acceptée si le matériel a déjà été produit ou si la phase de production a déjà été commencée, ni même si la livraison a déjà été effectuée. L'annulation de la commande comportera dans tous les cas l'obligation de la part de l'Acheteur de payer la totalité de la marchandise. Au cas où l'acceptation de l'annulation est faisable, le Client sera formellement tenu à recouvrir tous les frais engendrés par le producteur jusqu'alors.

**9) PRIX** Les prix reportés sur nos catalogues ne sont pas définitifs. Nous nous réservons le droit de les modifier avant l'acceptation de la commande.

**10) PAIEMENTS** Les paiements ne doivent être effectués qu'auprès de notre siège. Le retard de plus de 10 jours de tout paiement dû ou la non couverture dans le même délai d'un titre de crédit, transféré ou cédé, ou bien émis par l'Acheteur, constitue un niveau d'insolvabilité. Dans ce cas, il est en notre pouvoir de suspendre les livraisons et annuler tout rapport en cours; d'exiger le paiement intégral et immédiat de nos crédits; d'exiger le paiement intégral de tout en notre faveur et d'agir judiciairement à cet égard, de manière

exécutive ou préventive ainsi que pour les dommages et intérêts. Dans tous les cas, aussitôt qu'un paiement du dépasse le délai des 10 jours, nous sommes autorisés à émettre une traite à vue avec frais sans préavis. En outre, les intérêts moratoires annuels calculés en fonction du taux "premiers versements" courant majoré à 5 points pourcents, prendront effet sur le débit dépassé.

**11) MINIMUM UNITE DE VENTE** Aucune vente inférieure à la boîte ne peut être effectuée.

**12) COÛTS DE CONDITIONNEMENT** pour tous les articles de 170cm de long, un montant de 8€ par palette sera facturé pour l'emballage spécifique.

**13) DOMAINE RÉSERVÉ** Le matériel, même si livré et régulièrement facturé reste notre propriété jusqu'au paiement total de ladite marchandise, même en cas de passage ou vente à un tiers.

**14) TRIBUNAL COMPÉTENT** Le Tribunal de Modena sera compétent de manière exclusive en cas de litige.

## SERVICES LOGISTIQUES

**ANNULATION D'UNE COMMANDE** pour annuler une commande de matériaux déjà livrés à notre dépôt, et pour une restitution autorisée, une somme équivalente à 15 % de la valeur imposable vous sera débitée, avec un montant fixe minimum de 20 €, en tant que participation aux frais de transport et de resélection.

**COMMANDES MINIMUM** pour les commandes visant à "compléter" ou constituant des "expéditions individuelles" dont la valeur imposable est inférieure à 100 €, un supplément de 20 € net et fixe sera appliqué.

**CONTREMARQUE** pour toute commande inférieure à la palette, un montant fixe de 1,50 €/m<sup>2</sup> sera ajouté au prix d'achat.

**LIVRAISONS URGENTES** pour la préparation de commandes à livrer dans les 24 heures, avec une limite maximum de 2 articles en tout, un supplément de 30 € net et fixe sera appliqué.

# ALLGEMEINE VERKAUFSBEDINGUNGEN

- 1) **BESTÄTIGUNG** Eingegangene Bestellungen sind für uns nur verbindlich, wenn sie schriftlich durch uns bestätigt wurden.
- 2) **LIEFERUNG** Die Lieferung des Materials ist für uns mit dessen Beladung bei unserem Lager abgeschlossen. Alle durch den Transport bedingten Risiken, einschließlich Fehlmengen, Bruch, Beschädigung und sonstige Beeinträchtigungen gehen zu Lasten des Auftraggebers, auch wenn der vereinbarte Preis frachtfrei, FOB oder C&F ist. Die Vereinbarungen mit den Speditionsunternehmen werden im Namen und auf Rechnung des Auftraggebers getroffen, der die Entlastung bestätigt und erteilt.
- 3) **LIEFERFRISTEN** Die Lieferfristen sind ungefähre Angaben; im Falle einer Verzögerung, Unterbrechung bzw. teilweiser oder kompletter Aussetzung der Lieferungen besteht kein Recht auf Entschädigung oder Schadenersatz.
- 4) **BEANSTANDUNGEN** Die Garantie auf die Ware bezieht sich ausschließlich auf Material erster Wahl, bei einer Toleranz von ca. 5%. Unterschiede bei Farbtönen können nicht als Materialfehler geltend gemacht werden. Eventuelle Beanstandungen in Bezug auf die Qualität und Materialart müssen innerhalb von 8 Tagen ab dem Lieferdatum bei uns eingehen. Der Käufer verpflichtet sich, die beanstandeten Warenpartien für die Überprüfung der angezeigten Mängel zur Verfügung zu halten. Die Verlegung des Materials befreit uns in jedem Fall von jeglicher Haftung. Eventuelle Fehler oder Qualitätsmängel der Ware, sofern diese innerhalb der gesetzlich vorgeschriebenen Fristen gemeldet, überprüft und anerkannt wurden, beinhalten lediglich das Recht auf einen Umtausch der fehlerhaften Materialien, unter der Bedingung, dass die beanstandete Ware vorher, nach schriftlicher Genehmigung der Warenrückgabe, zurückgeschickt wurde und unter Verzicht und Ausschluss des Anspruchs auf eine Vertragsauflösung oder jegliche Art von Schadenersatz.
- 5) **ABMESSUNGEN UND FARBTÖNE** Unsere Materialien sind als Produkte klassifiziert, die bei hohen Temperaturen gebrannt werden, weshalb es sein kann, dass die tatsächlichen Abmessungen von den genannten Abmessungen abweichen. Das gleiche gilt für Farbunterschiede innerhalb desselben Warenpostens. Diese Umstände geben dem Auftraggeber kein Recht zu Beanstandungen.
- 6) **VERPACKUNG UND MENGE** Mit Annahme der Ware durch das Beförderungsunternehmen gelten der gute Zustand der Verpackungen sowie die übergebene Warenmenge als bestätigt. Das Transportunternehmen übernimmt mit Unterzeichnung des Versandscheins die Verantwortung für den guten Zustand und die Menge des Materials. Der Käufer muss sich im Fall von Brüchen oder Fehlware für eventuelle Schäden oder Entschädigungen an das Beförderungsunternehmen wenden.
- 7) **WARENRÜCKGABE** Der Käufer kann die Ware in keinem Fall ohne unsere ausdrückliche schriftliche Genehmigung zurückgeben; alle entstehenden Kosten werden vom Auftraggeber übernommen.
- 8) **STORNIERUNGEN** Auftragsstornierungen werden nicht akzeptiert, wenn das Material bereits hergestellt wurde, die Produktion angelaufen ist oder die Ware gar bereits verschickt wurde. Bei der Stornierung einer Bestellung ist der Auftraggeber in jedem Fall verpflichtet, die gesamte Lieferung zu bezahlen. Falls die Stornierung akzeptiert wird, ist der Kunde verpflichtet, alle Kosten zu übernehmen, die dem Hersteller bis zu diesem Zeitpunkt entstanden sind.
- 9) **PREISE** - Die in unserer Preisliste angegebenen Preise sind für uns nicht verbindlich. Wir behalten uns das Recht vor, diese vor der Bestellaufnahme zu ändern.
- 10) **ZAHLUNG** - Die Zahlungen können nur direkt an uns erfolgen. Eine Verspätung von mehr als 10 Tagen jeder geschuldeten Zahlung bzw. die fehlende Deckung eines girierten, abgetretenen oder vom Auftraggeber ausgestellten Kreditpapiers innerhalb desselben Zeitraums wird als Zahlungsunfähigkeit gewertet. In diesem Fall haben wir das Recht, die Lieferungen auszusetzen und jedes bestehende Geschäftsverhältnis abzubrechen; unverzüglich die vollständige Zahlung aller unserer Forderungen im Rahmen eines Vollstreckungs- oder Sicherstellungsverfahrens rechtlich zu beanspruchen, ebenso wie eine Entschädigung; in jedem Fall sind wir 10 Tage nach Ablauf der Zahlungsfrist berechtigt, ohne Vorankündigung eine Sichteinlage zuzüglich der entsprechenden Kosten auszustellen. Außerdem werden auf den geschuldeten Betrag die jährlichen Verzugszinsen in Höhe des laufenden, um fünf Prozentpunkte erhöhten Privatdiskontsatzes berechnet.
- 11) **VERPACKUNGSGRÖSSE** Es werden keine Mengen unterhalb der Größe eines Kartons verkauft.
- 12) **SONDERVERPACKUNGSZUSCHLAG** zu allen Produkten auf Länge 170 cm wird wegen Sonderverpackung ein Fix-Zuschlag in der Höhe von 8,00 € angewandt werden.
- 13) **EIGENTUMSVORBEHALT** Das Material bleibt auch bei regulärem Transport und normaler Rechnungsstellung bis zur vollständigen Bezahlung der Lieferung in unserem Eigentum, auch im Falle der Weitergabe oder des Verkaufs an Dritte.
- 14) **GERICHTSSTAND** Gerichtsstand in Streitfällen ist ausschließlich das Gericht Modena.

## LOGISTIC SERVICES

**STORNIERUNG VON BESTELLUNGEN** Für die Genehmigte Stornierung von Bestellungen von bereits an unser Lager gelieferten Materialien, und für autorisierte Rückgaben, werden 15% des Steuerwertes bzw. mindestens 20 € als Kostenbeitrag für den Transport und die erneute Auswahl in Rechnung gestellt.

**MINDESTBESTELLUNGEN** für beschränkte Bestellungen zur „Fertigstellung“ oder „Einzelabfertigung“, deren Steuerwert unter 100 € liegt, wird ein fixer Nettoaufschlag von 20 € in Rechnung gestellt.

**KOMMISSIONSZUSCHLAG** zu allen als eine volle Paletten geringere Aufträge wird ein Zuschlag von 1,50 €/Qm angewandt werden.

**DRINGENDE AUFTRÄGE** Zu Aufträgen, die ausnahmsweise in 24 Stunden abgewickelt werden sollen, wird ein Fix-Zuschlag von 30,00 € angewandt werden.

# ОБЩИЕ УСЛОВИЯ ПРОДАЖИ

- **ПОДТВЕРЖДЕНИЕ** - Поступившие к нам заказы действительны только после нашего письменного подтверждения.
- **ПОСТАВКА** - Поступившие к нам считаются выполненными в момент окончания погрузки на наш склад. Заказчик несет все риски, связанные с транспортировкой, включая недостачу, поломку, порчу и нарушение целостности упаковки, также если на продукцию установлен ценник фирмы-порт, FOB или C&F. Соглашения с экспедитором мы всегда заключаем от имени и за счет Заказчика, который с момента заключения соглашения утверждет и примет сделанную работу.
- **СРОКИ ПОСТАВКИ** - Сроки поставки имеют ориентировочный характер, возможна задержка поставки, ее приостановка, частичное или полное прекращение деятельности при возмещении убытков или компенсации ущерба.
- **ПРЕДЪЯВЛЕНИЕ ПРЕТЕНЗИЙ** - Гарантийные требования предъявляются только и исключительно на первосортный материал с допуском емым отклонением приблизительно на 5%. Различия в оттенках не будут считаться дефектом материала. Возможные претензии в отношении качества, тип материала должны быть предъявлены в течение 8 дней с даты поставки. Покупатель обязуется предоставить признанные им дефектными партии товара для проверки обоснованности претензии; в любом случае, после укладки материала мы не несем никакой ответственности. Возможные выявленные или подтвержденные недостатки или дефекты качества товара, при условии, что покупатель заявил о них в течение установленных сроков, подлежат покупке только на замену дефектного материала, которая осуществляется после возврата дефектного товара и на основании акта о возврате товара, составленного в письменной форме, при этом категорически исключается от договора или его расторжение, также какое-либо возмещение убытков.
- **РАЗМЕРЫ И ОТТЕНКИ** - Наши материалы относятся к продуктам, которые подвергаются обжигу при высокой температуре, поэтому заявленные и реальные размеры поставленных изделий могут отличаться. Это касается и различий в оттенках изделий из одной и той же партии. В связи с этим размеры и оттенки не могут быть предметом рекламации со стороны заказчика.
- **УПАКОВКА И КОЛИЧЕСТВО** - Перевозчик должен проконтролировать груз по количеству и целостности упаковки при приемке товара. Перевозчик, подписывая Сопроводительную Накладную, несет ответственность за сохранность материала и за его количество. В случае обнаружения повреждений и недостачи возможные претензии о возмещении ущерба за понесенные убытки покупатель должен предъявлять перевозчику.
- **ВОЗВРАТ ТОВАРА** - Покупатель не может ни в каком основании осуществлять возврат товара без нашего предварительного письменного согласия. Все расходы будут отнесены на счет Заказчика.
- **АННУЛИРОВАНИЕ ЗАКАЗА** - Отмененный заказ не будет приниматься, если материал уже изготовлен, или если уже было начато его производство, тем более, если уже был произведен отпек. В любом случае, при отмене заказа Заказчик будет обязан произвести оплату всей поставки. Если отмененный заказ будет возможен, Клиент должен будет возместить все расходы, понесенные производителем до момента отмены.
- **ЦЕНЫ** - Цены, указанные в нашем прайс-листе, имеют ориентировочный характер. Мы оставляем за собой право изменить цены перед принятием заказа.
- **ПЛАТЕЖИ** - Оплата товара должна производиться только прямым платежом. Задержка более чем на 10 дней каждого причитающегося платежа при отсутствии покрытия в срок векселя, который был передан, уступлен или выставлен заказчиком, является состоянием неплатежеспособности. В таком случае мы оставляем за собой право приостановить поставку, отменить все текущие отношения, также немедленно потребовать полной выплаты каждого из задолженностей и обратиться по этому поводу в суд, в исполнительном или предупредительном порядке, также с требованием возмещения ущерба; в любом случае, по истечении 10 дней с даты причитающегося платежа, мы имеем право без предупреждения выписать переводный вексель на предъявителя с оплатой издержек. Кроме того, на просроченную задолженностьчисляются проценты по неустойке по текущей процентной ставке 5% годовых.
- **РАСПАКОВКА КОРОБОК** - Продаваемый товар осуществляется только целыми заводскими коробками.
- **СТОИМОСТЬ УПАКОВКИ** - для всех изделий длиной 170 см, в качестве стоимости бильного взноса для специальной упаковки, будет взиматься сумма в размере 8 € за поддон.
- **ПРАВО УДЕРЖАНИЯ ТОВАРА** - товар остается нашей собственностью до момента полной оплаты поставки даже в случае, если был произведен отпек, и был выставлен счет-фактура также в случае передан или продан товар третьим лицам.
- **КОМПЕТЕНТНЫЙ СУД** - Рассмотрение любых споров будет проходить в исключительной компетенции Суда г. Модены.

## ЛОГИСТИЧЕСКИЕ УСЛУГИ

**ОТМЕНА ЗАКАЗОВ** – в случае отмены заказа на поставку материалов, уже поставленных на наш склад, покупатель обязан оплатить 15% от общей суммы их стоимости, также минимальную фиксированную сумму в размере 20€, взимаемую в качестве оплаты транспортных расходов и пересортировки.

**МИНИМАЛЬНЫЙ ЗАКАЗ** – в случае ограниченных заказов, представляющих собой как «отдельные заказы», так и «дополнения» к другим заказам, общей суммой стоимости которых составляет менее 100€, применяется чистая фиксированная надбавка в размере 20€.

**НЕ ПОЛНЫЙ ПОДДОН** – для заказов менее чем полный поддон, стоимость каждого квадратного метра плитки будет увеличена на 1,50€.

**СРОЧНЫЕ ПОСТАВКИ** – при подготовке заказов в течение 24 часов, содержащих максимум 2 артикула, применяется чистая фиксированная надбавка в размере 30€.





[www.abk.it](http://www.abk.it)

