

ETILE®

ETILE®

ELAM®



ELAM

Diseños de gran formato para todo tipo de proyectos

La colección de ELAM está compuesta por una gama de colores monocromáticos, cementos y mármoles en formato 260 x 120cm y con 6mm y 7mm de espesor. Los pavimentos coordinados en 120 x 120cm de 10mm de espesor complementan la colección.

Los diseños y formatos de ELAM son fáciles de adaptar en todo tipo de proyectos relacionados con la arquitectura, diseño y decoración de complejos residenciales, locales comerciales, instalaciones sanitarias, centros educativos, deportivos y culturales, aeropuertos, edificios y residencias gubernamentales, o proyectos del sector hotelero.

Large format designs suitable for every project

ELAM collection is made up of monochromatic colours, cements and marbles in size 260 x 120cm. of 6mm. and 7mm. thickness. Coordinated floor tiles in size 120 x 120cm, 10mm. complete the portfolio.

ELAM designs and sizes are easy to adapt to every architectural project, decoration or design of residential, commercial sites, cultural, educational and health-care centres, sports facilities, airports, government buildings and residence or hospitality projects.

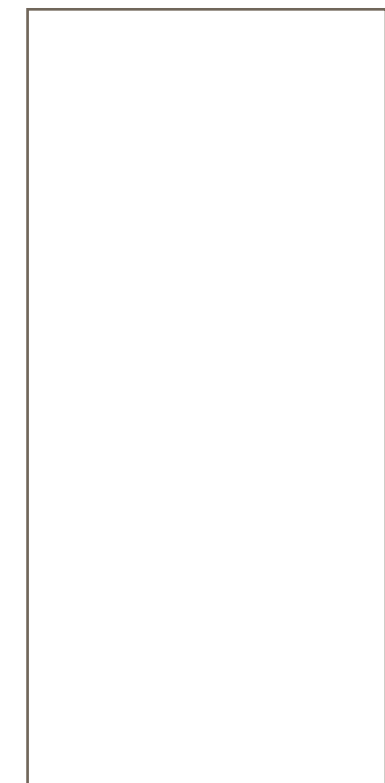

260 x 120 cm. / 102,3x47,2"
Espesor / Thickness
6 & 7 mm.

Inspirado en la arquitectura de vanguardia

ETILE®

Nuestras colecciones se diseñan bajo un criterio técnico y estético que imprime al producto un alto grado de versatilidad y singularidad. Son colecciones de carácter sobrio y minimalista, en las que el formato y la sutileza de los matices de sus texturas crean piezas únicas y exclusivas.

En ETILE tenemos como misión la satisfacción de nuestros clientes. Queremos cubrir sus necesidades y apostamos fielmente por una atención personalizada, un servicio excelente, una calidad sobresaliente y un diseño óptimo.

Además utilizamos la última tecnología digital del mercado, lo que nos permite cuidar hasta el mínimo detalle y generar sorprendentes acabados, relieves, destonificados, tramas y formatos.

Descubre las nuevas colecciones y comprueba todas las opciones de combinabilidad que te ofrecemos.

Inspired by avant-guard architecture

Our collections, designed by under technical and aesthetic criteria, stamp to our product a high versatility and singularity. Minimalist collections of sober character in which the format and the subtlety of the nuances of their textures create unique and exclusive pieces.

In ETILE, we have as target, the satisfaction of our customers. We want to satisfy your needs betting faithfully for a personalized attention an excellent service, outstanding quality and optimal design.

We also use the latest digital technology in the market, allowing us to take care to the minimum detail, generating amazing finishes, reliefs, shades, wefts and formats.

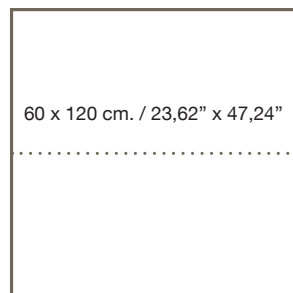

60 x 120 cm. / 23,62" x 47,24"



75 x 150 cm. / 29,52" x 59,06"



20 x 120 cm. / 7,87" x 47,2"



75 x 75 cm. / 29,52" x 29,52"



60 x 60 cm. / 23,62" x 23,62"

33,3 x 100 cm. / 13,11" x 39,37"
Pasta blanca

120 x 120 cm. / 47,2 x 47,2"

25 x 150 cm. / 9,84" x 59,06"



INDEX MODELS / ÍNDICE ALFABÉTICO

Porcelain tiles / Porcelánico

ALPES	12	ESSENTIAL	42	TRIBECA	88
ALWAYS <i>New</i>	14	FACTORY	54	VENATO	102
AUSTRAL	18	KONTEMPO <i>New</i>	58		
ÁVALON	20	MARLOW <i>New</i>	62		
BLANCO	26	MATERIA <i>New</i>	64		
CALCITA	30	STONHENGE	66		
CARAVAGGIO	36	SUPREME	74		
CORCHIA <i>New</i>	38	SUTILE	76		

White body tiles / Pasta blanca

ÁVALON	24
CALCITA	34
SNOW	28
STONHENGE	72
SUTILE	86
TRIBECA	100
VENATO	110

INDEX MODELS / ÍNDICE ALFABÉTICO

ALPES	12	ESSENTIAL	42	SUTILE	76
ALWAYS <i>New</i>	14	FACTORY	54	TRIBECA	88
AUSTRAL	18	KONTEMPO <i>New</i>	58	VENATO	102
ÁVALON	20	MARLOW <i>New</i>	62		
BLANCO	26	MATERIA <i>New</i>	64		
CALCITA	30	SNOW	28		
CARAVAGGIO	36	STONHENG	66		
CORCHIA <i>New</i>	38	SUPREME	74		



INDEX BY SIZE / ÍNDICE FORMATO

PORCELAIN TILES PORCELÁNICO

260 x 120 / 102,36" x 47,24"

ALWAYS <i>New</i>	14
ÁVALON	20
BLANCO	26
CARAVAGGIO	36
CORCHIA <i>New</i>	38
ESSENTIAL	46
KONTEMPO <i>New</i>	58
TRIBECA	92
VENATO	102

120 x 120 / 47,24" x 47,24"

ALWAYS <i>New</i>	14
ÁVALON	20
BLANCO	24
CARAVAGGIO	36
CORCHIA <i>New</i>	38
ESSENTIAL	46
KONTEMPO <i>New</i>	58
TRIBECA	92
VENATO	102

75 x 150 / 29,52" x 59,06"

ALWAYS <i>New</i>	14
ÁVALON	20
CALCITA	30
CORCHIA <i>New</i>	40
ESSENTIAL	42
FACTORY	54
MATERIA <i>New</i>	64
STONHENGE	66
SUTILE	76
TRIBECA	88
VENATO	104

25 x 150 / 9,84" x 59,06"

ALPES	12
AUSTRAL	18
SUPREME	74

20 x 120 / 7,87" x 47,20"

AUSTRAL	18
SUPREME	74

75 x 75 / 29,52" x 29,52"

ALWAYS <i>New</i>	14
ÁVALON	20
CALCITA	30
CORCHIA <i>New</i>	40
ESSENTIAL	42
FACTORY	54
STONHENGE	66
SUTILE	76
TRIBECA	88
VENATO	104

60 x 120 / 23,62" x 47,24"

ALWAYS <i>New</i>	14
CALCITA	30
CARAVAGGIO	36
CORCHIA <i>New</i>	38
ESSENTIAL	46
FACTORY	54
KONTEMPO <i>New</i>	58
MARLOW <i>New</i>	62

MATERIA <i>New</i>	64
SUTILE	76
TRIBECA	78
VENATO	102

60 x 60 / 23,62" x 23,62"

STONHENGE	66
TRIBECA	88

WHITE BODY TILES PASTA BLANCA

33,3 x 100 / 13,11" x 39,37"

ÁVALON	24
CALCITA	34
SNOW	28
STONHENGE	72
SUTILE	86
TRIBECA	100
VENATO	110

Alpes

Porcelánico - Porcelain Tiles

Wall: Tribeca Gris 75 x 150 cm. / Floor: Alpes Nogal 25 x 150 cm.



Alpes Arce
25 x 150 cm.

PR2515L



Alpes Roble
25 x 150 cm.

PR2515R



Alpes Nogal
25 x 150 cm.

PR2515R



RODAPIÉ CORTE 8 x 75 cm.
CUT SKIRTING 3,14" x 29,52"

Ejemplos de colocación / Examples of placement



Se aconseja uso del Sistema Nivelado
We recommend using Levelling System to lay the tiles
Ver pág. 125 / See page 125



Always

Porcelánico - Porcelain Tiles

New collection



ELAM



Always Pulido
260 x 120 cm.

EL2612V



Always Pulido
60 x 120 cm.

PR6012P



Always Pulido
120 x 120 cm.

PR1212V

Wall: Always Pulido 260 x 120 cm. / Floor: Always Pulido 260 x 120 cm.



Always

Porcelánico - Porcelain Tiles

New collection

Wall: Always Pulido 75 x 150 cm. / Floor: Always Pulido 75 x 150 cm.



Always Pulido
75 x 150 cm.

PR7515P



Always Pulido
75 x 75 cm.

PR7575P



Se aconseja uso del Sistema Nivelado
We recommend using Levelling System to lay the tiles
Ver pág. 125 / See page 125

Austral

Porcelánico - Porcelain Tiles

Wall: Tribeca Greige 75 x 150 cm. / Floor: Austral Blanco 25 x 150 cm.



Austral Beige 25 x 150 cm. PR2515R



Austral Beige 20 x 120 cm. PR2012L



Austral Blanco 25 x 150 cm. PR2515R



Austral Blanco 20 x 120 cm. PR2012L



Austral Gris 25 x 150 cm. PR2515R



Austral Gris 20 x 120 cm. PR2012L



RODAPIÉ CORTE 10 x 75 cm.
CUT SKIRTING 3,93" x 29,52"

Ejemplos de colocación / Examples of placement

Se aconseja uso del Sistema Nivelado
We recommend using Levelling System to lay the tiles
Ver pág. 125 / See page 125



Ávalon

Porcelánico - Porcelain Tiles



ELAM



Ávalon Marfil Pulido
260 x 120 cm.

EL2612P



Ávalon Marfil Pulido
75 x 75 cm.

PR7575P



Ávalon Marfil Pulido
75 x 150 cm.

PR7515P



Ávalon Marfil Pulido
120 x 120 cm.

PR1212P

Variación gráfica | Different patterns: 3

Espesor | Thickness: 7 mm.



RODAPIÉ CORTE 8 x 75 cm. / 10 x 60 cm.
CUT SKIRTING 3,14" x 29,52" / 3,93" x 23,62"

Se aconseja uso del Sistema Nivelado
We recommend using Levelling System to lay the tiles
Ver pág. 125 / See page 125

Wall: Ávalon Marfil Pulido 75 x 150 cm. / Floor: Ávalon Marfil Pulido 75 x 150 cm.



Ávalon

Porcelánico - Porcelain Tiles



E L A M



Ávalon Gris Pulido
260 x 120 cm.

EL2612P



Ávalon Gris Pulido
75 x 75 cm.

PR7575P



Ávalon Gris Pulido
75 x 150 cm.

PR7515P



Ávalon Gris Pulido
120 x 120 cm.

PR1212P

Variación gráfica | Different patterns: 3

Espesor | Thickness: 7 mm.



RODAPIÉ CORTE 8 x 75 cm. / 10 x 60 cm.
CUT SKIRTING 3,14" x 29,52" / 3,93" x 23,62"

Wall: Ávalon Gris Pulido 260 x 120 cm. / Floor: Ávalon Gris Pulido 120 x 120 cm.



Se aconseja uso del Sistema Nivelado
We recommend using Levelling System to lay the tiles
Ver pág. 125 / See page 125

Ávalon

Pasta blanca - White Body Tiles



Ávalon Marfil Gloss
33,3 x 100 cm.

WB3310LB



Rectangles Ávalon Marfil Gloss
33,3 x 100 cm.

WB3310RB



Ávalon Gris Gloss
33,3 x 100 cm.

WB3310LB



Rectangles Ávalon Gris Gloss
33,3 x 100 cm.

WB3310RB

PAVIMENTO COORDINADO / COORDINATED FLOOR TILES

Ávalon Gris/Marfil
75 x 150 cm. / 75 x 75 cm. / 120 x 120 cm.



RODAPIÉ CORTE 8 x 75 cm.
CUT SKIRTING 3,14" x 29,52"

Wall: Ávalon Marfil Gloss 33,3 x 100 cm. Rectangles Ávalon Marfil Gloss 33,3 x 100 cm. / Floor: Ávalon Marfil Pulido 75 x 150 cm.



Blanco

Porcelánico - Porcelain Tiles



ELAM

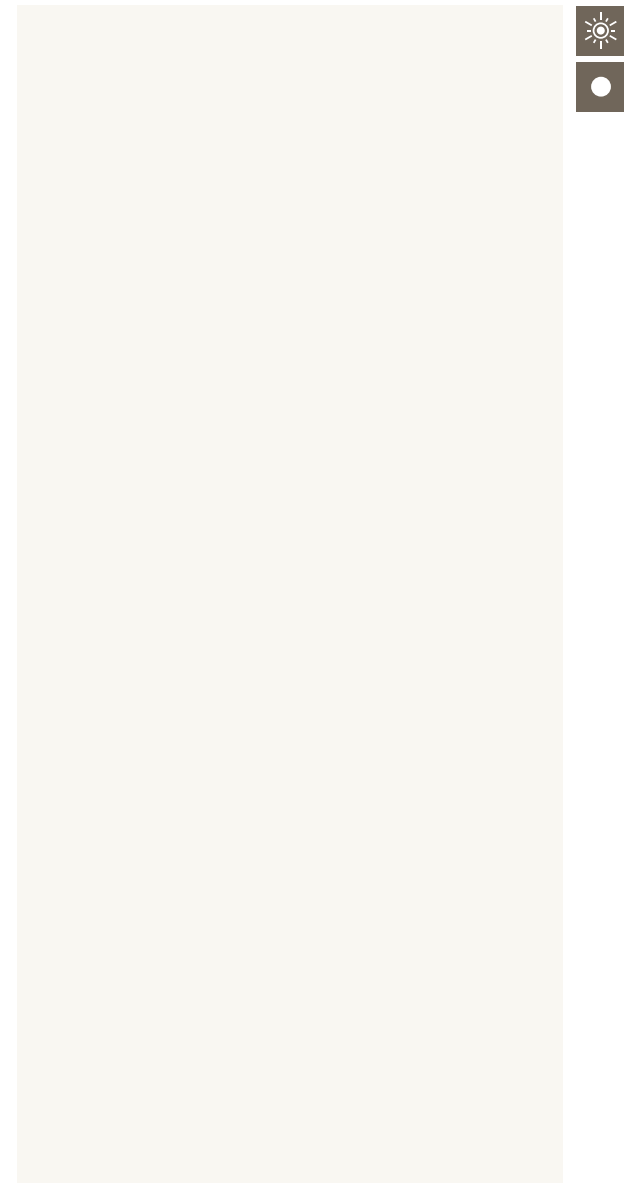

Blanco Natural 260 x 120 cm.
Blanco Pulido 260 x 120 cm.

EL2612L
EL2612V

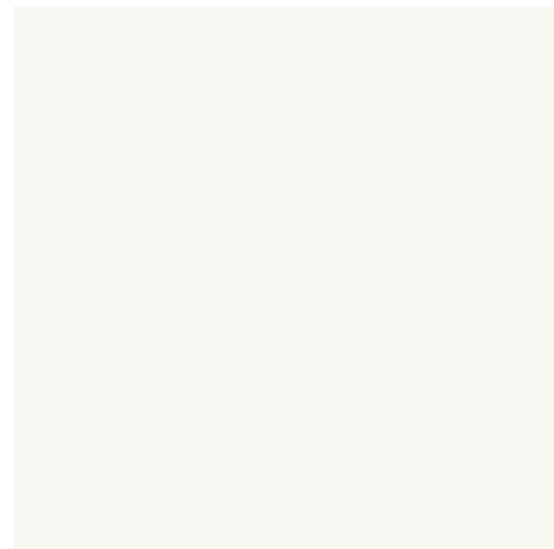

Blanco Natural 120 x 120 cm.
Blanco Pulido 120 x 120 cm.

PR1212L
PR1212V

Espesor | Thickness: 6 mm. Natural
Espesor | Thickness: 7 mm. Pulido

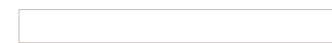

RODAPIÉ CORTE 10 x 60 cm.
CUT SKIRTING 3,93" x 23,62"

 Se aconseja uso del Sistema Nivelado
We recommend using Levelling System to lay the tiles
Ver pág. 125 / See page 125

Wall: Blanco Pulido 260 x 120 cm. / Floor: Blanco Pulido 120 x 120 cm.



Snow

Pasta blanca - White Body Tiles

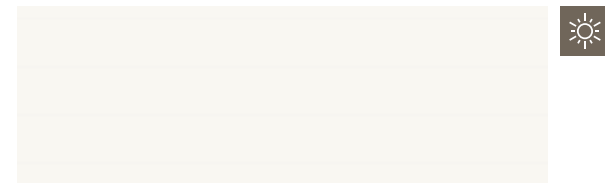

Snow White Gloss
33,3 x 100 cm. WB3310LB



Mare Snow White Gloss
33,3 x 100 cm. WB3310RB

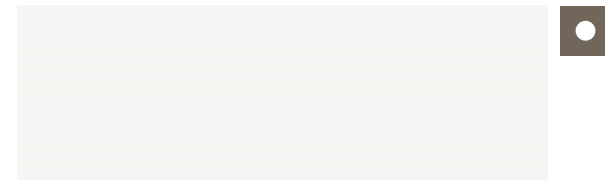

Snow White Matt
33,3 x 100 cm. WB3310L



Mare Snow White Matt
33,3 x 100 cm. WB3310R

PAVIMENTO COORDINADO / COORDINATED FLOOR TILES

Calcita Gris
75 x 150 cm.



RODAPIÉ CORTE 8 x 75 cm.
CUT SKIRTING 3,14" x 29,52"

Wall: Snow White Matt 33,3 x 100 cm. Mare Snow White Matt 33,3 x 100 cm. Calcita Gris 33,3 x 100 cm.
Floor: Calcita Gris 75 x 75 cm.



Se aconseja uso del Sistema Nivelado
We recommend using Levelling System to lay the tiles
Ver pág. 125 / See page 125

Calcita

Porcelánico - Porcelain Tiles



Calcita Arena 60 x 120 cm. PR6012L



Calcita Arena 75 x 150 cm. PR7515L



Calcita Arena 75 x 75 cm. PR7575L

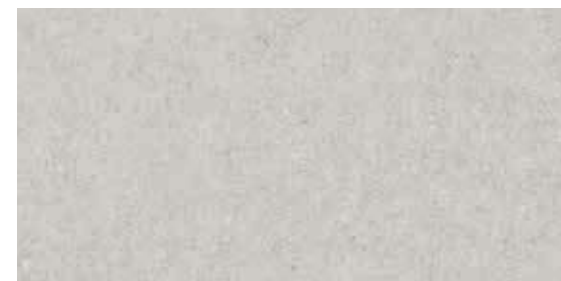

Calcita Perla 60 x 120 cm. PR6012L



Calcita Perla 75 x 150 cm. PR7515L

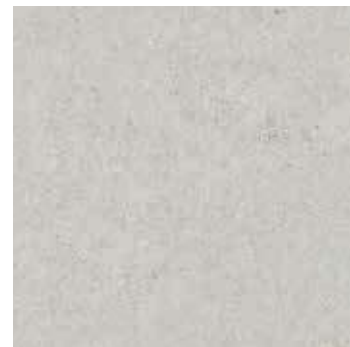

Calcita Perla 75 x 75 cm. PR7575L

Wall: Calcita Antracita 75 x 150 cm. / Floor: Calcita Perla 75 x 150 cm.



Se aconseja uso del Sistema Nivelado
We recomend using Levelling System to lay the tiles
Ver pág. 125 / See page 125

Calcita

Porcelánico - Porcelain Tiles

Wall: Calcita Gris 33,3 x 100 cm. / Floor: Calcita Gris 75 x 75 cm.



Calcita Gris 60 x 120 cm. PR6012L



Calcita Gris 75 x 150 cm. PR7515L



Calcita Gris 75 x 75 cm. PR7575L



Calcita Antracita 60 x 120 cm. PR6012E



Calcita Antracita 75 x 150 cm. PR7515E



Calcita Antracita 75 x 75 cm. PR7575E



Se aconseja uso del Sistema Nivelado
We recommend using Levelling System to lay the tiles
Ver pág. 125 / See page 125

Calcita

Pasta blanca - White Body Tiles



Calcita Arena
33,3 x 100 cm. WB3310L



Section Calcita Arena
33,3 x 100 cm. WB3310R



Contrast Calcita Arena
33,3 x 100 cm. WB3310LB



Calcita Perla
33,3 x 100 cm. WB3310L



Section Calcita Perla
33,3 x 100 cm. WB3310R



Contrast Calcita Perla
33,3 x 100 cm. WB3310LB



Calcita Gris
33,3 x 100 cm. WB3310L



Section Calcita Gris
33,3 x 100 cm. WB3310R



Calcita Antracita
33,3 x 100 cm. WB3310L

PAVIMENTO COORDINADO /
COORDINATED FLOOR TILES
Ávalon Gris / Marfil
75 x 150 cm. / 75 x 75 cm. / 120 x 120 cm.



RODAPIÉ CORTE 8 x 75 cm.
CUT SKIRTING 3,14" x 29,52"

 Se aconseja uso del Sistema Nivelado
We recommend using Levelling System to lay the tiles
Ver pág. 125 / See page 125

Wall: Calcita Arena 33,3 x 100 cm. Section Calcita Arena 33,3 x 100 cm. / Floor: Calcita Arena 75 x 75 cm.

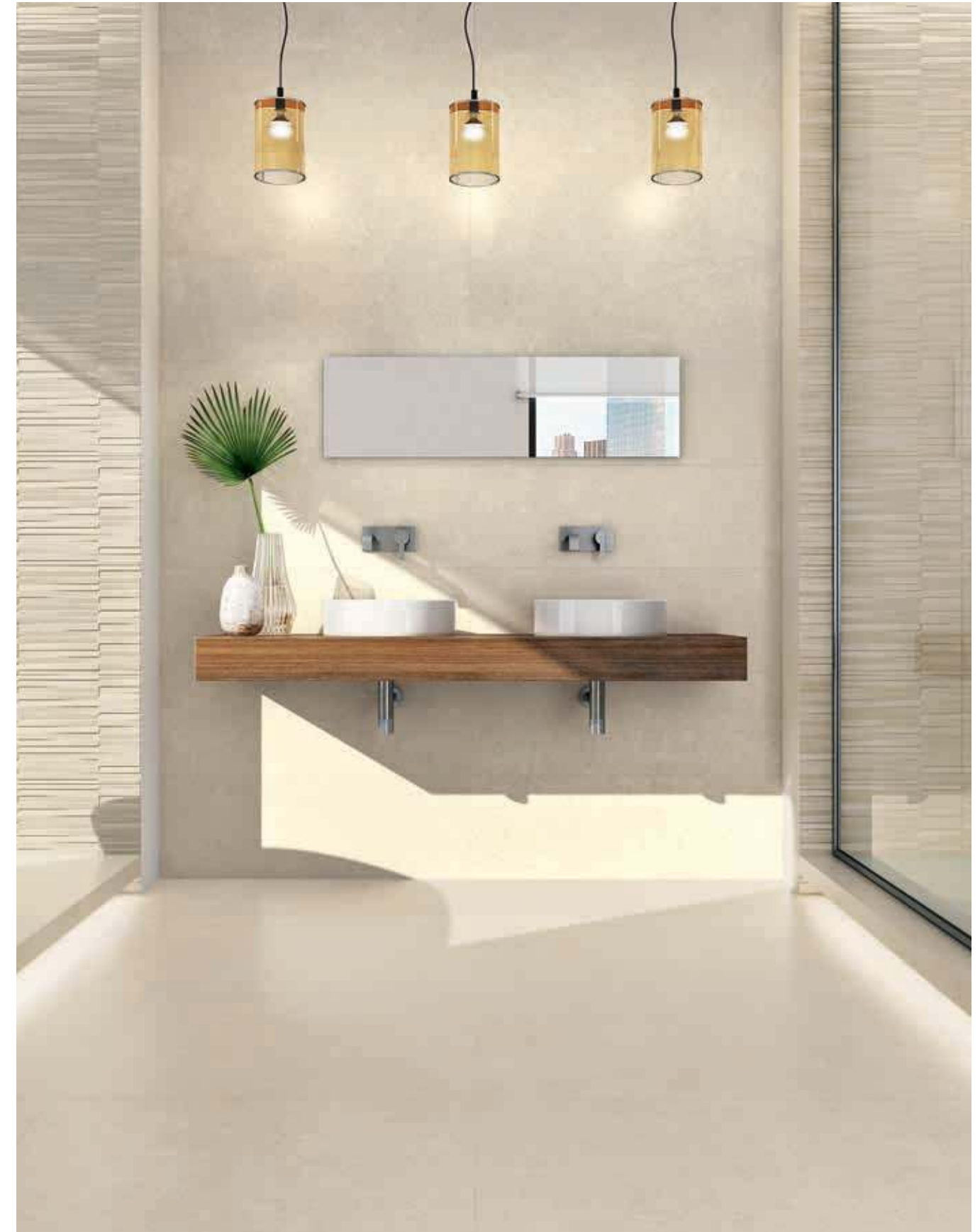

Caravaggio

Porcelánico - Porcelain Tiles



ELAM



Caravaggio Antracita Pulido
260 x 120 cm.

EL2612RP



Caravaggio Antracita Pulido
60 x 120 cm. PR6012GRP



Caravaggio Antracita Pulido
120 x 120 cm.

PR1212GRP

Espeor | Thickness: 7 mm.

Variación gráfica | Different patterns: 4



RODAPIÉ CORTE 10 x 60 cm.
CUT SKIRTING 3,93" x 23,62"

Se aconseja uso del Sistema Nivelado
We recommend using Levelling System to lay the tiles
Ver pág. 125 / See page 125

Wall: Caravaggio Antracita Pulido 260 x 120 cm. / Floor: Caravaggio Antracita Pulido 120 x 120 cm.

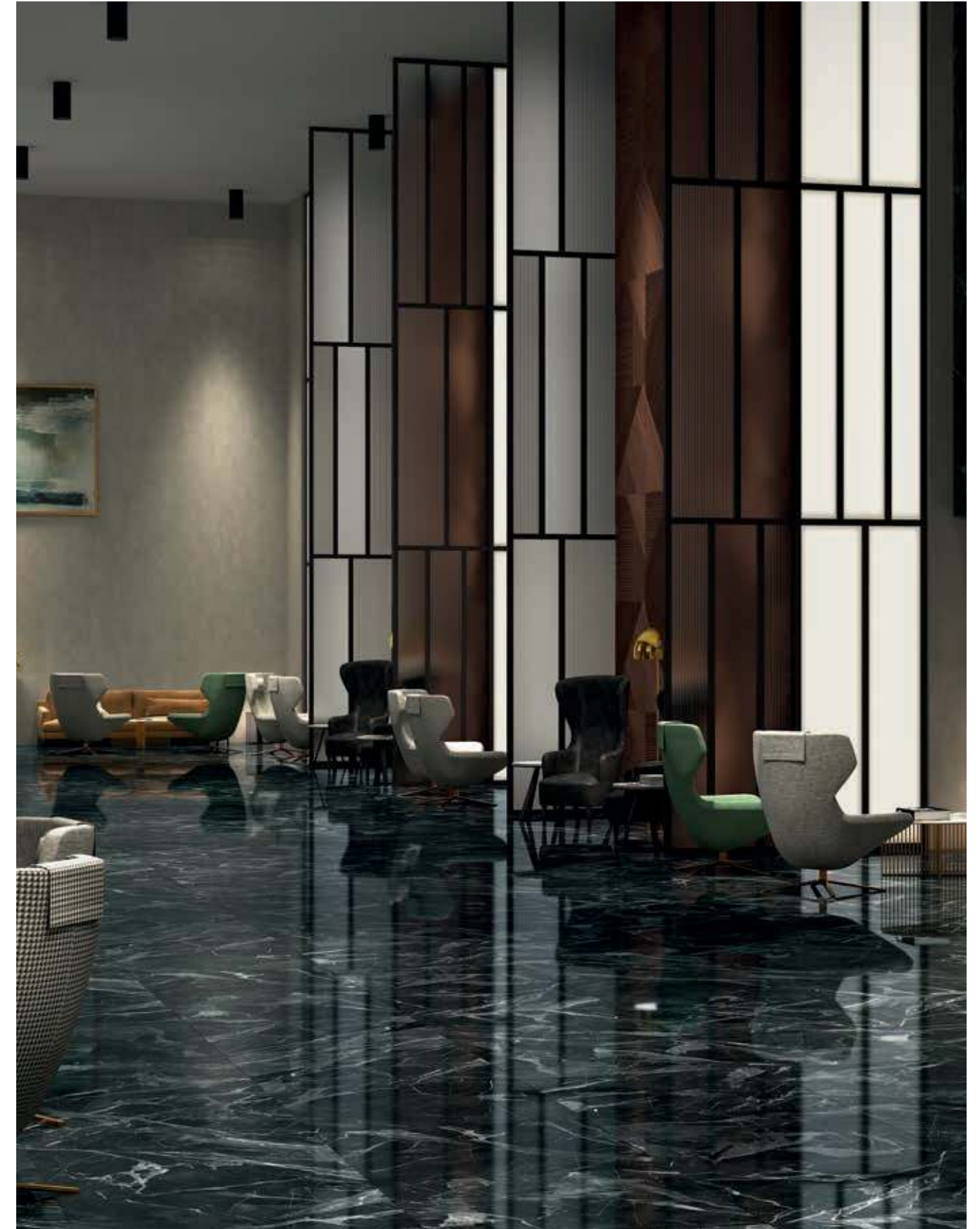

Corchia

Porcelánico - Porcelain Tiles

New collection



ELAM



Corchia Pulido
260 x 120 cm.

EL2612P



Corchia Pulido
60 x 120 cm.

PR6012P



Corchia Pulido
120 x 120 cm.

PR1212P

Espeor | Thickness: 7 mm.

Variación gráfica | Different patterns: 4



RODAPIÉ CORTE 10 x 60 cm.
CUT SKIRTING 3,93" x 23,62"

Se aconseja uso del Sistema Nivelado
We recommend using Levelling System to lay the tiles
Ver pág. 125 / See page 125

Wall: Corchia Pulido 260 x 120 cm. / Floor: Corchia Pulido 120 x 120 cm.



Corchia
Porcelánico - Porcelain Tiles

New collection

Wall: Corchia Pulido 75 x150 cm. / Floor: Corchia Pulido 75 x 75 cm.



Corchia Pulido
75 x 150 cm.

PR7515P



Corchia Pulido
75 x 75 cm.

PR7575P



RODAPIÉ CORTE 10 x 60 cm.
CUT SKIRTING 3,93" x 23,62"

Se aconseja uso del Sistema Nivelado
We recommend using Levelling System to lay the tiles
Ver pág. 125 / See page 125

Essential

Porcelánico - Porcelain Tiles

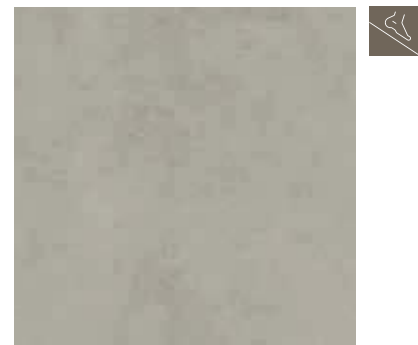

Essential Taupe
75 x 75 cm. PR7575L
75 x 75 cm. Anti-slip PR7575R



Essential Taupe
60 x 120 cm. PR6012L



Essential Taupe
75 x 150 cm. PR7515L

RODAPIÉ CORTE 8 x 75 cm / 10 x 60 cm.
CUT SKIRTING 3,14" x 29,52" / 3,93" x 23,62"



Wall: Essential Taupe 75 x 150 cm. / Floor: Essential Taupe 75 x 150 cm.



Se aconseja uso del Sistema Nivelado
We recommend using Levelling System to lay the tiles
Ver pág. 125 / See page 125

Essential

Porcelánico - Porcelain Tiles

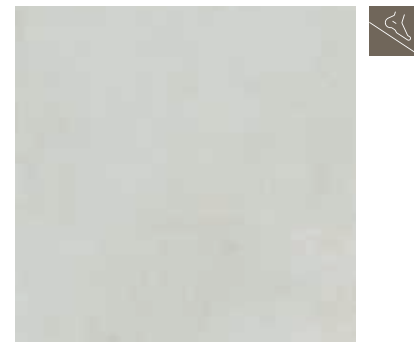

Essential Blanco
75 x 75 cm. PR7575L
75 x 75 cm. Anti-slip PR7575R



Essential Blanco
60 x 120 cm. PR6012L

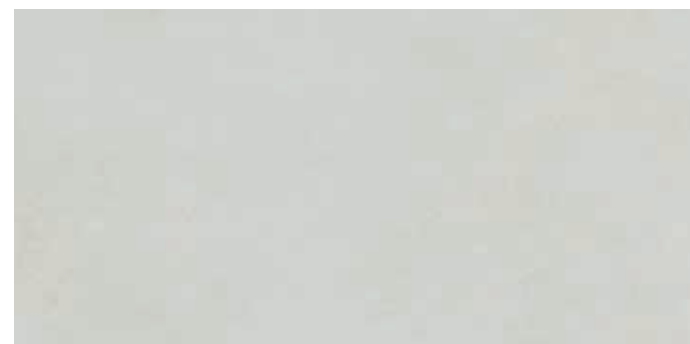

Essential Blanco
75 x 150 cm. PR7515L

RODAPIÉ CORTE 8 x 75 cm. / 10 x 60 cm.
CUT SKIRTING 3,14" x 29,52" / 3,93" x 23,62"



Wall: Essential Blanco 75 x 150 cm. / Essential Gris 75 x 150 cm. / Floor: Essential Blanco 75 x 150 cm.



Se aconseja uso del Sistema Nivelado
We recommend using Levelling System to lay the tiles
Ver pág. 125 / See page 125

Essential

Porcelánico - Porcelain Tiles



E L A M



Essential Perla
260 x 120 cm.

EL2612L

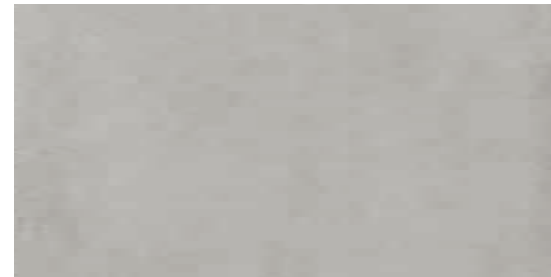

Essential Perla
60 x 120 cm.

PR6012L



Essential Perla
120 x 120 cm.

PR1212L

— Espesor | Thickness: 6 mm.

— Variación gráfica | Different patterns: 4



RODAPIÉ CORTE 10 x 60 cm.
CUT SKIRTING 3,93" x 23,62"

 Se aconseja uso del Sistema Nivelado
We recommend using Levelling System to lay the tiles
Ver pág. 125 / See page 125

Floor: Essential Perla 60 x 120 cm.

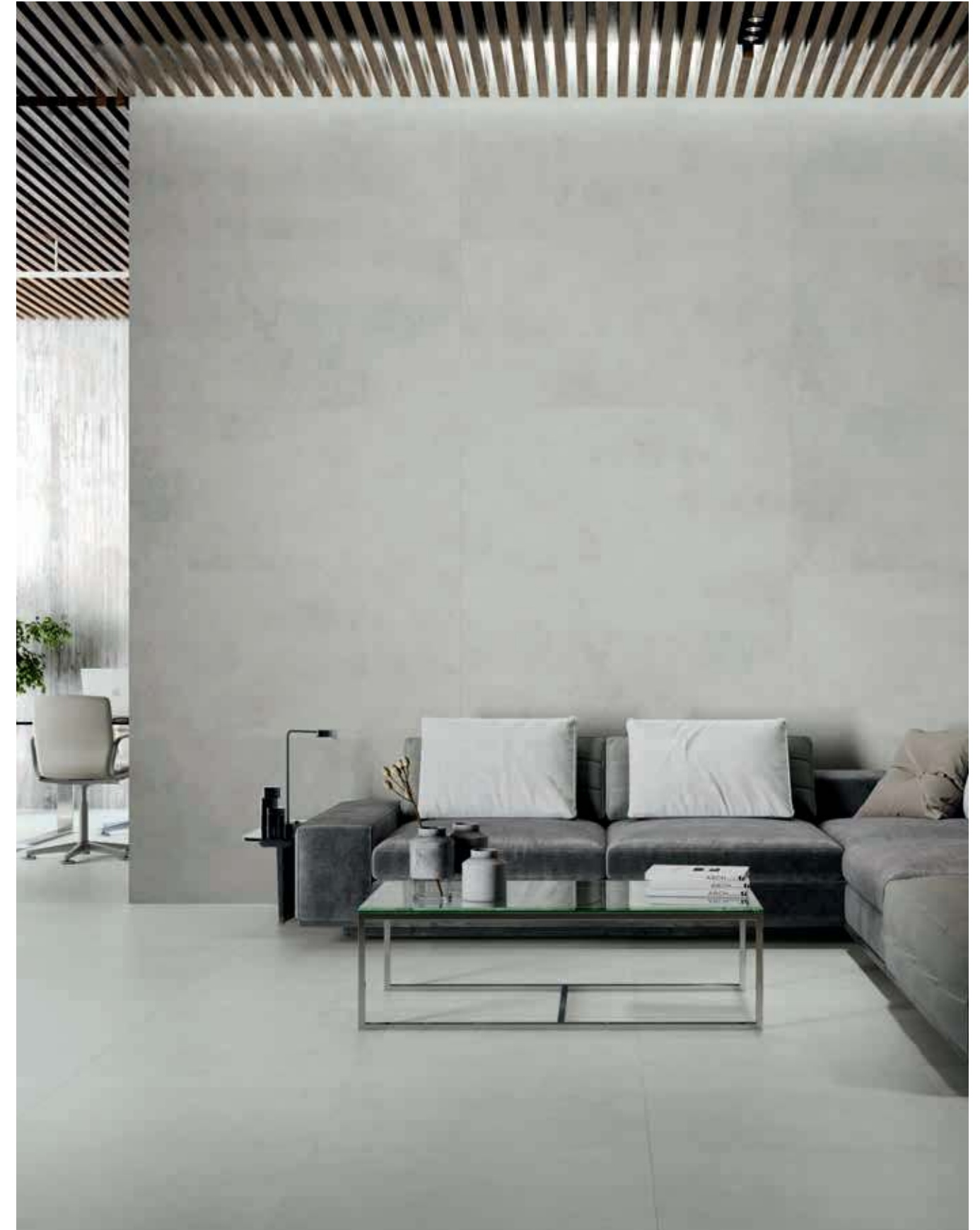

Essential

Porcelánico - Porcelain Tiles

Floor: Essential Perla 75 x 150 cm.



Essential Perla
75 x 150 cm.

PR7515L



Essential Perla
75 x 75 cm.
75 x 75 cm. Anti-slip

PR7575L
PR7575R



RODAPIÉ CORTE 8 x 75 cm.
CUT SKIRTING 3,14" x 29,52"



Se aconseja uso del Sistema Nivelado
We recommend using Levelling System to lay the tiles
Ver pág. 125 / See page 125

Essential

Porcelánico - Porcelain Tiles



ELAM



Essential Gris
260 x 120 cm.

EL2612L



Essential Gris
60 x 120 cm.

PR6012L



Essential Gris
120 x 120 cm.

PR1212L

— Espesor | Thickness: 6 mm.

— Variación gráfica | Different patterns: 4



RODAPIÉ CORTE 10 x 60 cm.
CUT SKIRTING 3,93" x 23,62"

Wall: Essential Gris 260 x 120 cm..

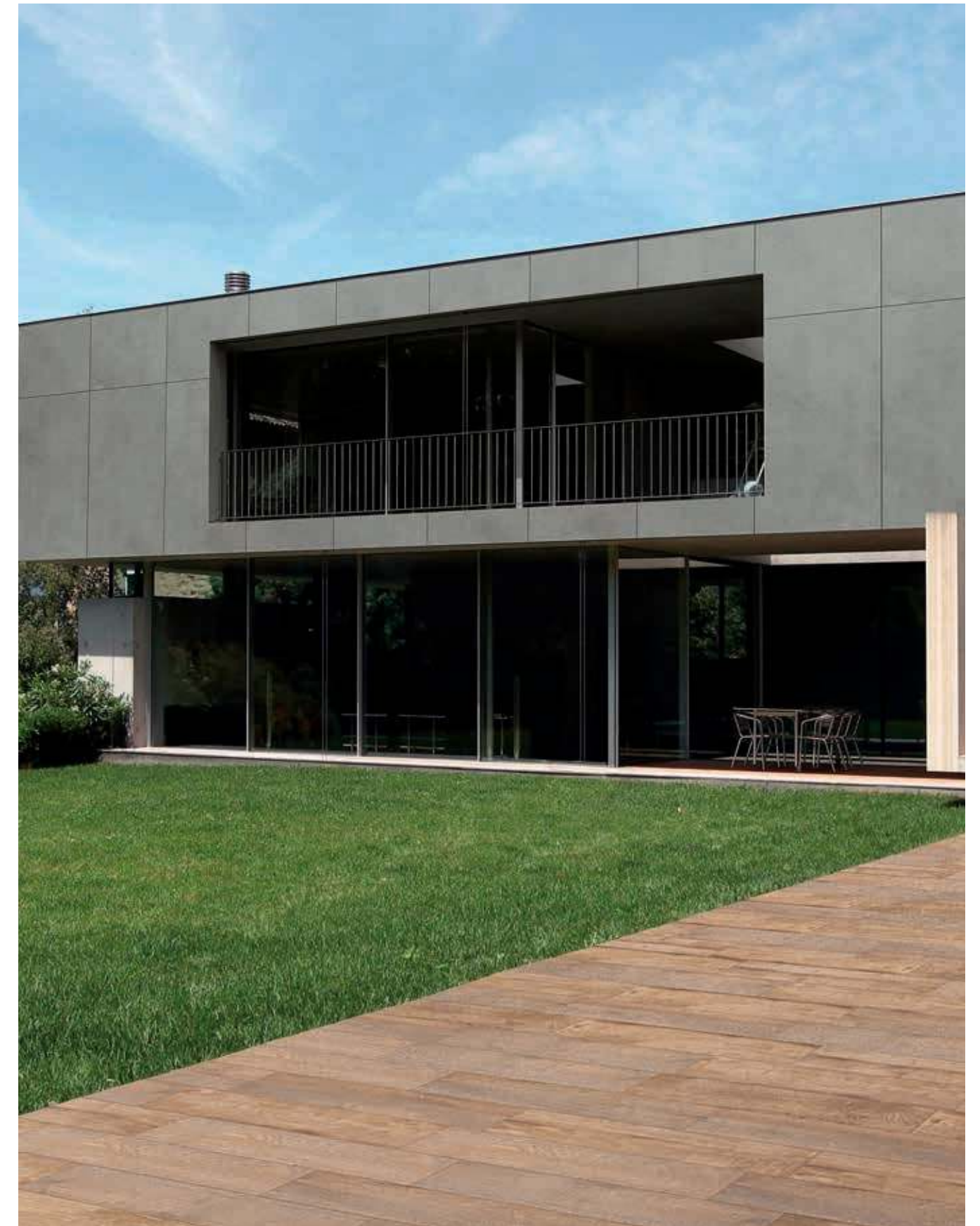

 Se aconseja uso del Sistema Nivelado
We recommend using Levelling System to lay the tiles
Ver pág. 125 / See page 125

Essential

Porcelánico - Porcelain Tiles

Floor: Essential Gris 75 x 150 cm.



Essential Gris
75 x 150 cm.

PR7515L



Essential Gris
75 x 75 cm.
75 x 75 cm. Anti-slip

PR7575L
PR7575R



RODAPIÉ CORTE 8 x 75 cm.
CUT SKIRTING 3,14" x 29,52"



Se aconseja uso del Sistema Nivelado
We recommend using Levelling System to lay the tiles
Ver pág. 125 / See page 125

Factory

Porcelánico - Porcelain Tiles



Factory Marfil Lappato 60 x 120 cm. PR6012C



Factory Marfil Lappato 75 x 150 cm. PR7515C



Factory Marfil Lappato 75 x 75 cm. PR7575C



Factory Óxido Lappato 60 x 120 cm. PR6012RC



Factory Óxido Lappato 75 x 150 cm. PR7515RC



Factory Óxido Lappato 75 x 75 cm. PR7575RC

Wall: Factory Marfil Lappato 75 x 150 cm. / Floor: Factory Óxido Lappato 75 x 150 cm.



Se aconseja uso del Sistema Nivelado
We recommend using Levelling System to lay the tiles
Ver pág. 125 / See page 125

Factory

Porcelánico - Porcelain Tiles



Factory Blanco Lappato 60 x 120 cm. PR6012C



Factory Blanco Lappato 75 x 150 cm. PR7515C



Factory Blanco Lappato 75 x 75 cm. PR7575C



Factory Titanio Lappato 60 x 120 cm. PR6012RC



Factory Titanio Lappato 75 x 150 cm. PR7515RC

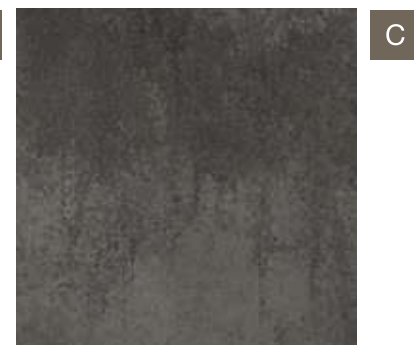

Factory Titanio Lappato 75 x 75 cm. PR7575RC

Wall: Factory Blanco Lappato 75 x 150 cm. / Floor: Factory Titanio Lappato 75 x 150 cm.

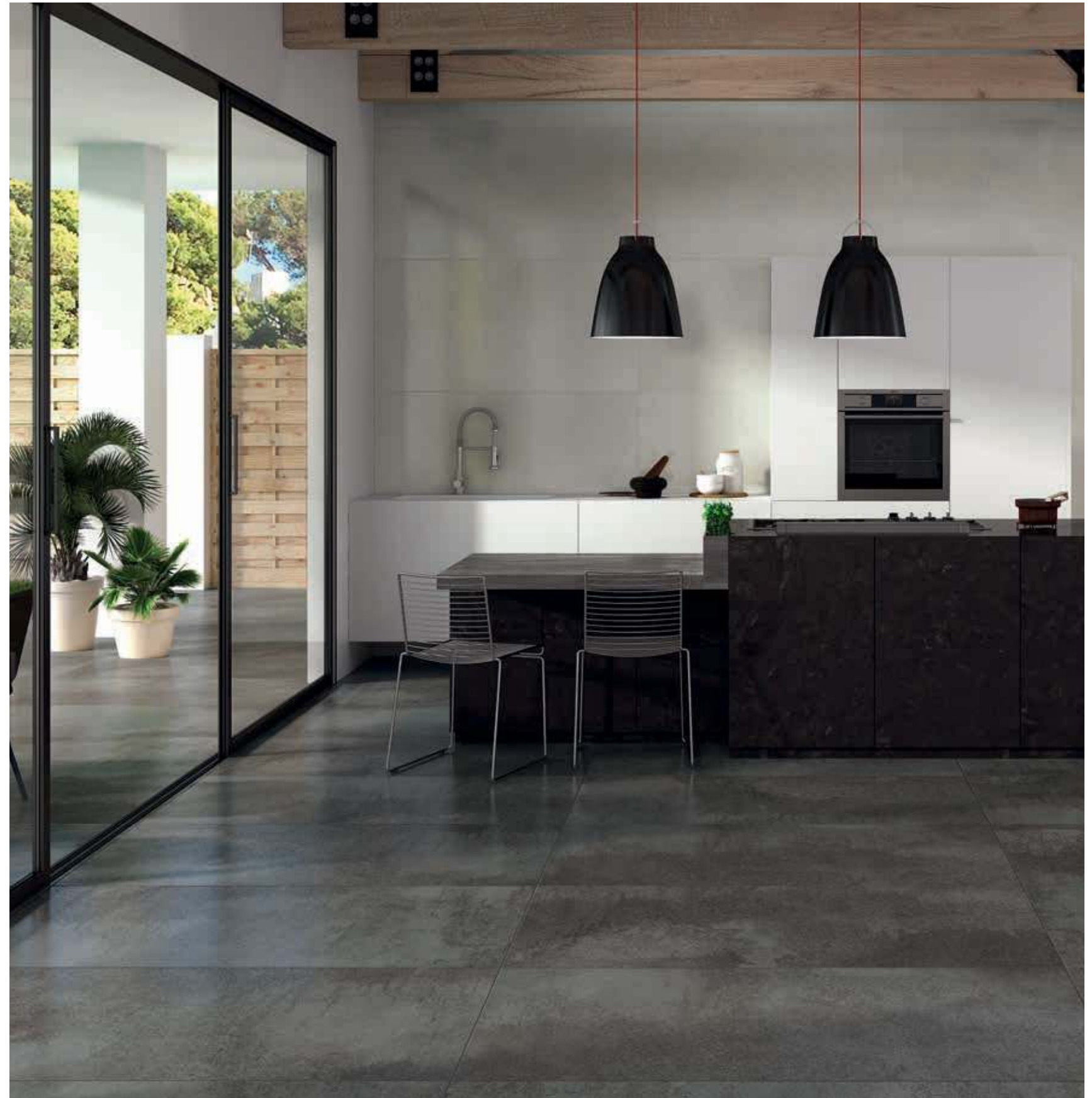

Se aconseja uso del Sistema Nivelado
We recomend using Levelling System to lay the tiles
Ver pág. 125 / See page 125

Kontempo

Porcelánico - Porcelain Tiles

New collection



E L A M



Kontempo Cream Pulido
260 x 120 cm.

EL2612P



Kontempo Cream Pulido
60 x 120 cm. PR6012P



Kontempo Cream Pulido
120 x 120 cm.

PR1212P

Espeor | Thickness: 7 mm.

Variación gráfica | Different patterns: 4



RODAPIÉ CORTE 10 x 60 cm.
CUT SKIRTING 3,93" x 23,62"



Se aconseja uso del Sistema Nivelado
We recommend using Levelling System to lay the tiles
Ver pág. 125 / See page 125

Wall: Kontempo Cream Pulido 260 x 120 cm. / Floor: Kontempo Cream Pulido 120 x 120 cm..

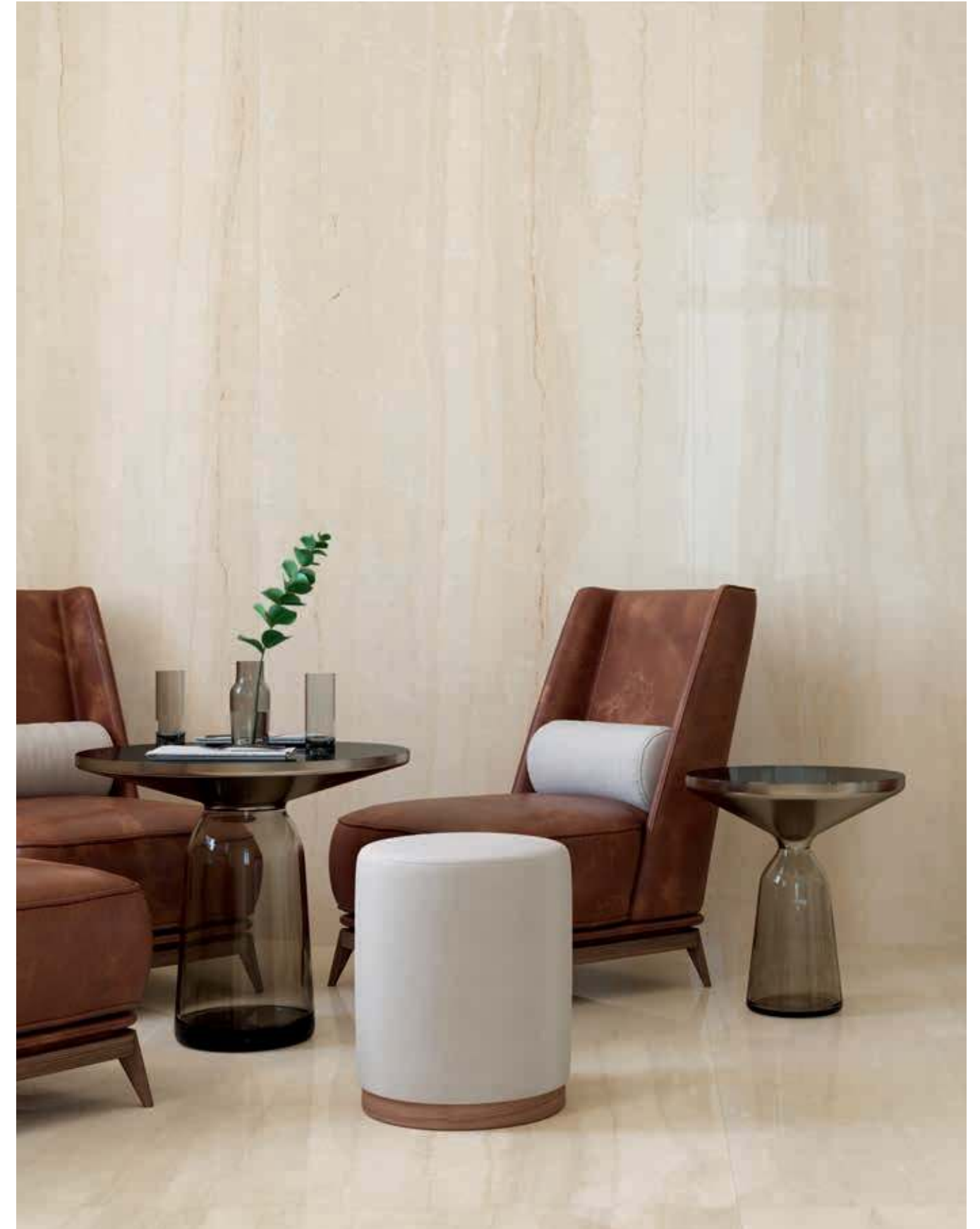

Kontempo
Porcelánico - Porcelain Tiles

New collection



E L A M



Kontempo Cinnamon Pulido
60 x 120 cm. PR6012P



Kontempo Cinnamon Pulido
120 x 120 cm. PR1212P

Kontempo Cinnamon Pulido
260 x 120 cm. EL2612P

Espeor | Thickness: 7 mm.

Variación gráfica | Different patterns: 4



RODAPIÉ CORTE 10 x 60 cm.
CUT SKIRTING 3,93" x 23,62"

Se aconseja uso del Sistema Nivelado
We recommend using Levelling System to lay the tiles
Ver pág. 125 / See page 125

Wall: Kontempo Cinnamon Pulido 260 x 120 cm. / Floor: Kontempo Cinnamon Pulido 120 x 120 cm.



Marlow

Porcelánico - Porcelain Tiles



Marlow Sabbia
60 x 120 cm. PR6012R



Marlow Cinza
60 x 120 cm. PR6012R

New collection

Wall: Marlow Cinza 60 x 120 cm. / Floor: Marlow Cinza 60 x 120 cm.



RODAPIÉ CORTE 10 x 60 cm.
CUT SKIRTING 3,93" x 23,62"

Se aconseja uso del Sistema Nivelado
We recomend using Levelling System to lay the tiles
Ver pág. 125 / See page 125

Materia

Porcelánico - Porcelain Tiles



Materia Mink
60 x 120 cm. PR6012L



Materia Mink
75 x 150 cm. PR7515L



Materia Moon
60 x 120 cm. PR6012L



Materia Moon
75 x 150 cm. PR7515L

New collection

Wall: Materia Mink 75 x 150 cm. / Floor: Materia Mink 60 x 120 cm.



Se aconseja uso del Sistema Nivelado
We recommend using Levelling System to lay the tiles
Ver pág. 125 / See page 125

Stonhenge

Porcelánico - Porcelain Tiles



Stonhenge Blanco
60 x 60 cm. PR6060L



Stonhenge Blanco
75 x 75 cm. Anti-slip PR7575R



Stonhenge Blanco
75 x 150 cm. Anti-slip PR7515R

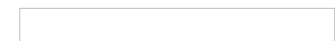

RODAPIÉ CORTE 8 x 75 cm. / 10 x 60 cm.
CUT SKIRTING 3,14" x 29,52" / 3,93" x 23,62"



Se aconseja uso del Sistema Nivelado
We recommend using Levelling System to lay the tiles
Ver pág. 125 / See page 125

Wall: Stonhenge Blanco 60 x 120 cm./ Floor: Stonhenge Blanco Anti-Slip 75 x 150 cm.



Stonhenge

Porcelánico - Porcelain Tiles



Stonhenge Perla
60 x 60 cm. PR6060L



Stonhenge Perla
75 x 75 cm. Anti-slip PR7575R



Stonhenge Perla
75 x 150 cm. Anti-slip PR7515R

RODAPIÉ CORTE 8 x 75 cm. / 10 x 60 cm.
CUT SKIRTING 3,14" x 29,52" / 3,93" x 23,62"

Wall: Stonhenge Perla 75 x 150 cm. / Floor: Stonhenge Perla Anti-slip 75 x 75 cm.



Se aconseja uso del Sistema Nivelado
We recommend using Levelling System to lay the tiles
Ver pág. 125 / See page 125

Stonhenge

Porcelánico - Porcelain Tiles



Stonhenge Antracita
60 x 60 cm. PR6060L

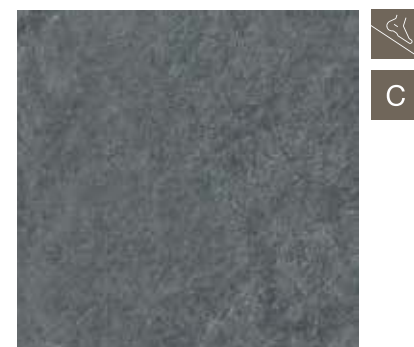

Stonhenge Antracita
75 x 75 cm. Anti-slip PR7575C



Stonhenge Antracita
75 x 150 cm. Anti-slip PR7515C

RODAPIÉ CORTE 8 x 75 cm. / 10 x 60 cm.
CUT SKIRTING 3,14" x 29,52" / 3,93" x 23,62"

Wall: Stonhenge Antracita 75 x 150 cm. / Floor: Stonhenge Antracita 75 x 75 cm.



 Se aconseja uso del Sistema Nivelado
We recommend using Levelling System to lay the tiles
Ver pág. 125 / See page 125

Stonhenge

Pasta blanca - White Body Tiles



Stonhenge Blanco
33,3 x 100 cm. WB3310L



Tessera Stonhenge Blanco
33,3 x 100 cm. WB3310R



Stonhenge Antracita
33,3 x 100 cm. WB3310L



Tessera Stonhenge Antracita
33,3 x 100 cm. WB3310R



Stonhenge Perla
33,3 x 100 cm. WB3310L



Tessera Stonhenge Perla
33,3 x 100 cm. WB3310R



Tessera Stonhenge Multicolor
33,3 x 100 cm. WB3310R



Chevron Stonhenge Multicolor
33,3 x 100 cm. WB3310LB

PAVIMENTO COORDINADO / COORDINATED FLOOR TILES

Calcita Gris
75 x 150 cm.



RODAPIÉ CORTE 8 x 75 cm.
CUT SKIRTING 3,14" x 29,52"



Se aconseja uso del Sistema Nivelado
We recommend using Levelling System to lay the tiles
Ver pág. 125 / See page 125

Wall: Stonhenge Perla 33,3 x 100 cm. Tessera Stonhenge Antracita 33,3 x 100 cm. / Floor: Stonhenge Perla 60 x 120 cm.



Supreme

Porcelánico - Porcelain Tiles

Floor: Supreme Roble 25 x 150 cm.



Supreme Haya 25 x 150 cm. PR2515L



Supreme Haya 20 x 120 cm. PR2012L



Supreme Castaño 25 x 150 cm. PR2515L



Supreme Castaño 20 x 120 cm. PR2012L



Supreme Roble 25 x 150 cm. PR2515L



Supreme Roble 20 x 120 cm. PR2012L



RODAPIÉ CORTE 8 x 75 cm.
CUT SKIRTING 3,14" x 29,52"

RODAPIÉ CORTE 10 x 60 cm.
CUT SKIRTING 3" x 25"



Ejemplos de colocación / Examples of placement

Se aconseja uso del Sistema Nivelado
We recommend using Levelling System to lay the tiles
Ver pág. 125 / See page 125



Sutile

Porcelánico - Porcelain Tiles



Sutile Marfil Pulido
75 x 75 cm. PR7575P



Sutile Marfil Pulido
60 x 120 cm. PR6012P



Sutile Marfil Pulido
75 x 150 cm. PR7515P



RODAPIÉ CORTE 8 x 75 cm. / 10 x 60 cm.
CUT SKIRTING 3,14" x 29,52" / 3,93" x 23,62"



Wall: Sutile Marfil Pulido 75 x 150 cm. / Floor: Sutile Marfil Pulido 75 x 75 cm.

Sutile

Porcelánico - Porcelain Tiles

Wall: Sutile Marfil 33,3 x 100 cm. / Floor: Sutile Taupe Pulido 75 x 75 cm.



Sutile Taupe Pulido
75 x 75 cm. PR7575P



Sutile Taupe Pulido
60 x 120 cm. PR6012P



Sutile Taupe Pulido
75 x 150 cm. PR7515P

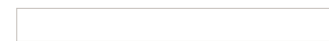

RODAPIÉ CORTE 8 x 75 cm. / 10 x 60 cm.
CUT SKIRTING 3,14" x 29,52" / 3,93" x 23,62"



Se aconseja uso del Sistema Nivelado
We recommend using Levelling System to lay the tiles
Ver pág. 125 / See page 125

Sutile

Porcelánico - Porcelain Tiles

Wall: Sutile Blanco Pulido 60 x 120 cm. / Floor: Sutile Blanco Pulido 75 x 75 cm.



Sutile Blanco Pulido
75 x 75 cm. PR7575P



Sutile Blanco Pulido
60 x 120 cm. PR6012P



Sutile Blanco Pulido
75 x 150 cm. PR7515P



RODAPIÉ CORTE 8 x 75 cm. / 10 x 60 cm.
CUT SKIRTING 3,14" x 29,52" / 3,93" x 23,62"



Se aconseja uso del Sistema Nivelado
We recommend using Levelling System to lay the tiles
Ver pág. 125 / See page 125

Sutile

Porcelánico - Porcelain Tiles

Wall: Sutile Gris 33,3 x 100 cm. / Floor: Sutile Perla Pulido 75 x 75 cm.



Sutile Perla Pulido
75 x 75 cm. PR7575P



Sutile Perla Pulido
60 x 120 cm. PR6012P



Sutile Perla Pulido
75 x 150 cm. PR7515P



RODAPIÉ CORTE 8 x 75 cm. / 10 x 60 cm.
CUT SKIRTING 3,14" x 29,52" / 3,93" x 23,62"



Se aconseja uso del Sistema Nivelado
We recommend using Levelling System to lay the tiles
Ver pág. 125 / See page 125

Sutile

Porcelánico - Porcelain Tiles

Wall: Sutile Gris Pulido 75 x 150 cm. / Floor: Sutile Gris Pulido 75 x 150 cm.



Sutile Gris Pulido
75 x 75 cm. PR7575P



Sutile Gris Pulido
60 x 120 cm. PR6012P



Sutile Gris Pulido
75 x 150 cm. PR7515P



RODAPIÉ CORTE 8 x 75 cm. / 10 x 60 cm.
CUT SKIRTING 3,14" x 29,52" / 3,93" x 23,62"



Se aconseja uso del Sistema Nivelado
We recommend using Levelling System to lay the tiles
Ver pág. 125 / See page 125

Sutile

Pasta blanca - White Body Tiles



Sutile Marfil
33,3 x 100 cm.

WB3310LB



Sutile Blanco
33,3 x 100 cm.

WB3310LB



Mare Sutile Marfil
33,3 x 100 cm.

WB3310RB



Mare Sutile Blanco
33,3 x 100 cm.

WB3310RB



Sutile Taupe
33,3 x 100 cm.

WB3310LB



Sutile Perla
33,3 x 100 cm.

WB3310LB



Mare Sutile Taupe
33,3 x 100 cm.

WB3310RB



Mare Sutile Perla
33,3 x 100 cm.

WB3310RB



Sutile Gris
33,3 x 100 cm.

WB3310LB



Mare Sutile Gris
33,3 x 100 cm.

WB3310RB

PAV. COORDINADO / COORDINATED FLOOR TILES
Sutile Blanco / Perla / Taupe 60 x 60 cm.
Sutile Gris / Marfil Pulido 75 x 150 cm. / 60 x 60 cm.



RODAPIÉ CORTE 8 x 75 cm. / 10 x 60 cm.
CUT SKIRTING 3,14" x 29,52" / 3,93" x 23,62"

Wall: Sutile Blanco 33,3 x 100, Sutile Gris 33,3 x 100 cm. / Floor: Austral Gris 25 x 150 cm.



Tribeca

Porcelánico - Porcelain Tiles



Tribeca Blanco
60 x 120 cm.

PR6012L

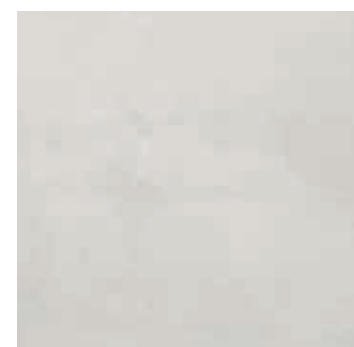

Tribeca Blanco
75 x 75 cm.
75 x 75 cm. Anti-Slip

PR7575L
PR7575R



Tribeca Blanco
60 x 60 cm.

PR6060L



Tribeca Blanco
75 x 150 cm.

PR7515L

RODAPIÉ CORTE 8 x 75 cm. / 10 x 60 cm.
CUT SKIRTING 3,14" x 29,52" / 3,93" x 23,62"

Wall: Tribeca Blanco 60 x 120 cm. / Floor: Tribeca Blanco 60 x 60 cm.



 Se aconseja uso del Sistema Nivelado
We recommend using Levelling System to lay the tiles
Ver pág. 125 / See page 125

Tribeca

Porcelánico - Porcelain Tiles



Tribeca Gris 60 x 120 cm.

PR6012L



Tribeca Gris
75 x 75 cm.
75 x 75 cm. Anti-Slip

PR7575L
PR7575R

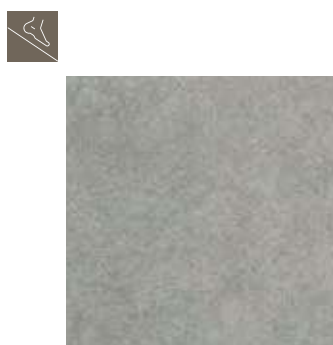

Tribeca Gris
60 x 60 cm.

PR6060L



Tribeca Gris
75 x 150 cm.

PR7515L

RODAPIÉ CORTE 8 x 75 cm. / 10 x 60 cm.
CUT SKIRTING 3,14" x 29,52" / 3,93" x 23,62"

Se aconseja uso del Sistema Nivelado
We recommend using Levelling System to lay the tiles
Ver pág. 125 / See page 125

Floor: Tribeca Gris 75 x 75 cm. Tribeca Gris Anti-slip 75 x 75 cm.



Tribeca

Porcelánico - Porcelain Tiles



ELAM



C



Tribeca Greige
60 x 60 cm. PR6060L



Tribeca Greige
60 x 120 cm. PR6012L



Tribeca Greige
120 x 120 cm. PR1212L

Tribeca Greige
260 x 120 cm. EL2612L

— Espesor | Thickness: 6 mm.

— Variación gráfica | Different patterns: 4



RODAPIÉ CORTE 10 x 60 cm.
CUT SKIRTING 3,93" x 23,62"

Se aconseja uso del Sistema Nivelado
We recommend using Levelling System to lay the tiles
Ver pág. 125 / See page 125

Wall: Tribeca Perla, Tribeca Greige 260 x 120 cm. / Floor: Tribeca Perla 120 x 120 cm.



Tribeca

Porcelánico - Porcelain Tiles

Wall: Tribeca Greige 75 x 150 cm. / Floor: Tribeca Greige 75 x 75 cm.



Tribeca Greige
75 x 150 cm.

PR7515L



Tribeca Greige
75 x 75 cm.
75 x 75 cm. Anti-Slip

PR7575L
PR7575R



RODAPIÉ CORTE 8 x 75 cm.
CUT SKIRTING 3,14" x 29,52"



Se aconseja uso del Sistema Nivelado
We recommend using Levelling System to lay the tiles
Ver pág. 125 / See page 125

Tribeca

Porcelánico - Porcelain Tiles



ELAM



C



Tribeca Perla
60 x 60 cm. PR6060L



Tribeca Perla 60 x 120 cm. PR6012L



Tribeca Perla
120 x 120 cm. PR1212L

Tribeca Perla
260 x 120 cm. EL2612L

Espesor | Thickness: 6 mm.

Variación gráfica | Different patterns: 4



RODAPIÉ CORTE 10 x 60 cm.
CUT SKIRTING 3,93" x 23,62"



Se aconseja uso del Sistema Nivelado
We recommend using Levelling System to lay the tiles
Ver pág. 125 / See page 125

Wall: Tribeca Perla 60 x 60 cm. / Floor: Tribeca Perla 60 x 120 cm.



Tribeca

Porcelánico - Porcelain Tiles

Wall: Tribeca Perla 75 x 150 cm. / Floor: Tribeca Perla 75 x 75 cm.



Tribeca Perla
75 x 150 cm.

PR7515L



Tribeca Perla
75 x 75 cm.
75 x 75 cm. Anti-Slip

PR7575L
PR7575R



RODAPIÉ CORTE 8 x 75 cm.
CUT SKIRTING 3,14" x 29,52"



Se aconseja uso del Sistema Nivelado
We recommend using Levelling System to lay the tiles
Ver pág. 125 / See page 125

Tribeca

Pasta blanca - White Body Tiles



Tribeca Perla
33,3 x 100 cm.

WB3310L



Tribeca Blanco
33,3 x 100 cm.

WB3310L



Rectangles Tribeca Perla
33,3 x 100 cm.

WB3310R



Rectangles Tribeca Blanco
33,3 x 100 cm.

WB3310R



Tribeca Greige
33,3 x 100 cm.

WB3310L



Tribeca Gris
33,3 x 100 cm.

WB3310L



Rectangles Tribeca Greige
33,3 x 100 cm.

WB3310R



Rectangles Tribeca Gris
33,3 x 100 cm.

WB3310R



Hexagon Tribeca Multicolor
33,3 x 100 cm.

WB3310LB

PAVIMENTO COORDINADO / COORDINATED FLOOR TILES

Tribeca Blanco / Greige / Perla / Gris
75 x 150 cm. / 30x60 cm. / 75 x 75 cm. / 60x120 cm.



RODAPIÉ CORTE 8 x 75 cm.
CUT SKIRTING 3,14" x 29,52"

Wall: Tribeca Gris 75 x 75 cm. Rectangles Tribeca Gris 33,3 x 100 cm. / Floor: Tribeca Gris 75 x 75 cm.



 Se aconseja uso del Sistema Nivelado
We recommend using Levelling System to lay the tiles
Ver pág. 125 / See page 125

Venato

Porcelánico - Porcelain Tiles



ELAM



Venato White Pulido
260 x 120 cm.

EL2612V



Venato White Pulido
60 x 120 cm. PR6012V



Venato White Pulido
120 x 120 cm.

PR1212V

Espesor | Thickness: 7 mm.

Variación gráfica | Different patterns: 6



RODAPIÉ CORTE 8 x 75 cm.
CUT SKIRTING 3,14" x 29,52"



Se aconseja uso del Sistema Nivelado
We recommend using Levelling System to lay the tiles
Ver pág. 125 / See page 125

Wall: Venato White Pulido 260 x 120 cm. / Floor: Venato White Pulido 260 x 120 cm.

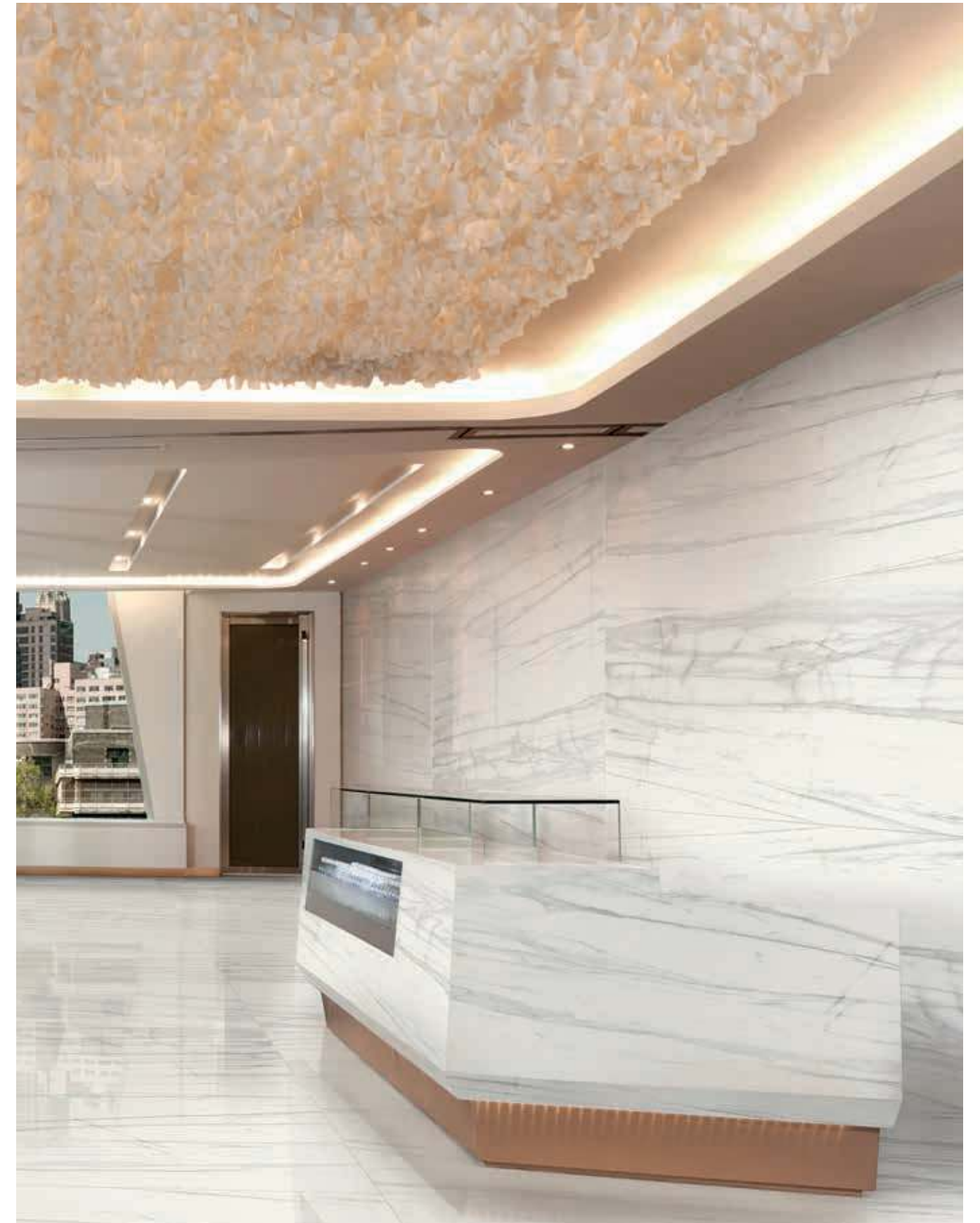

Venato

Porcelánico - Porcelain Tiles

Wall: Venato White Pulido 75 x 150 cm. / Floor: Venato White Pulido 75 x 75 cm.



Venato White Pulido
75 x 150 cm.

PR7515P



Venato White Pulido
75 x 75 cm.

PR7575P



RODAPIÉ CORTE 8 x 75 cm.
CUT SKIRTING 3,14" x 29,52"



Se aconseja uso del Sistema Nivelado
We recommend using Levelling System to lay the tiles
Ver pág. 125 / See page 125

Venato

Porcelánico - Porcelain Tiles



E L A M



Venato Gold Pulido
260 x 120 cm.

EL2612V



Venato Gold Pulido
60 x 120 cm. PR6012V



Venato Gold Pulido
120 x 120 cm.

PR1212V

Espesor | Thickness: 7 mm.

Variación gráfica | Different patterns: 6



RODAPIÉ CORTE 8 x 75 cm.
CUT SKIRTING 3,14" x 29,52"



Se aconseja uso del Sistema Nivelado
We recommend using Levelling System to lay the tiles
Ver pág. 125 / See page 125

Wall: Venato Gold Pulido 260 x 120 cm. / Floor: Venato Gold Pulido 120 x 120 cm.



Venato

Porcelánico - Porcelain Tiles

Wall: Venato Gold Pulido 75 x 150 cm. / Floor: Venato Gold Pulido 75 x 75 cm.



Venato Gold Pulido
75 x 150 cm.

PR7515P



Venato Gold Pulido
75 x 75 cm.

PR7575P



RODAPIÉ CORTE 8 x 75 cm.
CUT SKIRTING 3,14" x 29,52"



Se aconseja uso del Sistema Nivelado
We recommend using Levelling System to lay the tiles
Ver pág. 125 / See page 125

Venato

Pasta blanca - White Body Tiles

Wall: Venato Gold Gloss 33,3 x 100 cm. / Floor: Venato Gold Pulido 120 x 120 cm.

PB    NR R



Venato White Gloss
33,3 x 100 cm.

WB3310LB



Strada Venato White Gloss
33,3 x 100 cm.

WB3310RB



Venato Gold Gloss
33,3 x 100 cm.

WB3310LB



Strada Venato Gold Gloss
33,3 x 100 cm.

WB3310RB

PAVIMENTO COORDINADO / COORDINATED FLOOR TILES

Venato White / Gold
75 x 150 cm. / 75 x 75 cm. / 120 x 120 cm.



RODAPIÉ CORTE 8 x 75 cm. / 10 x 60 cm.
CUT SKIRTING 3,14" x 29,52" / 3,93" x 23,62"



Se aconseja uso del Sistema Nivelado
We recommend using Levelling System to lay the tiles
Ver pág. 125 / See page 125

Iconos y formatos
Icons and sizes

Lista de embalaje
Packing list

Formato Cm.	Size Inches
Porcelánico / Porcelain Tile	
260 X 120	102,36" X 47,24"
120 X 120	47,24" X 47,24"
60 X 120	23,62" X 47,24"
75 X 150	29,52" X 59,06"
25 X 150	9,84" X 59,06"
20X120	7,87" X 44,88"
75 X 75	29,52" X 29,52"
60 X 60	23,62" X 23,62"
Pasta Blanca / White Body Tile	
33,3 X 100	13,11" X 39,437"

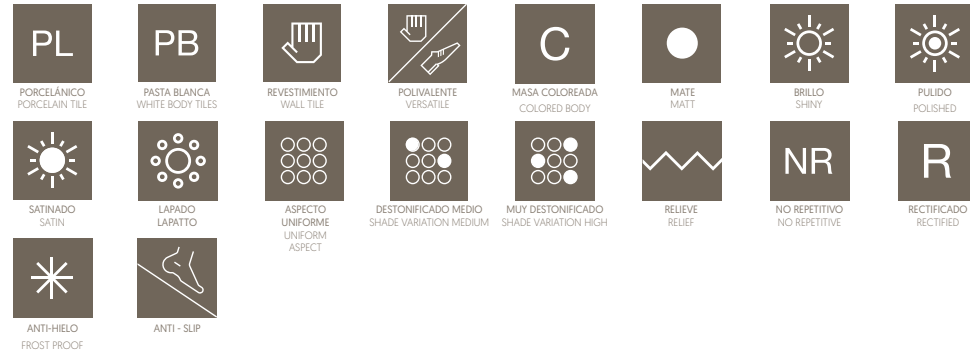

Formato Size	Pzas/Caja Pcs/Box	m²/Caja Sqm/Box	Kg/Caja Kg/Box	Cajas/Pallet Boxes/Pallet	Sqm/Pallet m²/Pallet	Kg/Pallet Kg/Pallet	Container/Pallet	Container m²/Sqm
120 x 120 cm.	1	1,44	32,5	40	57,6	1.360	12	691,2
60 x 120 cm.	2	1,44	32,50	32	46,08	1.072	33	1.520
60 x 60 cm.	3	1,08	23	48	51,84	1.104	24	1.244,2
20 x 120 cm.	4	0,96	22,5	48	46,08	1.080	33	1.504,8
75 x 150 cm.	1	1,13	24,5	40	45,2	980	21	949,2
25 x 150 cm.	3	1,13	24,5	50	56,5	1.225	21	1.186,5
75 x 75 cm.	2	1,13	24,5	40	45,2	980	20	904
33,3 x 100 cm.	4	1,33	26	48	63,84	1.248	20	1.276,80

SHADE VARIATION PROGRAM SCALE

ESCALA DE DESTONIFICACIÓN DEL COLOR

DESTONIFIED LIGHT

Clearly distinguishable differences in texture and/or pattern with similar colors.

DESTONIFICADO BAJO

Diferencias claramente perceptibles en textura y/o diseño pero con colores similares.

DESTONIFIED MEDIUM

While the colors present on a single piece of tile will be indicative of the colors to be expected on other tiles, the amount of color on each piece will vary significantly.

DESTONIFICADO MEDIO

La intensidad del color de cada pieza puede variar significativamente, aunque los colores presentes en una baldosa serán representativos de los colores que cabe esperar en el resto de baldosas.

DESTONIFIED INTENSE

Random color differences from tile to tile, so that one tile may have totally different colors from on other tiles. Thus, the final installation will be unique.

DESTONIFICADO ALTO

Diferencias de color aleatorias entre unas baldosas y otras, de manera que cada una de ellas puede tener colores completamente distintos de las demás. De este modo, la colocación final será única.

Aplicaciones

Applications

REFURBISHING OR REMODELLING INTERIORS such as commercial sites, residential or cultural spaces, health care centres, sport facilities or hotels among others. The slim material can be easily installed over existing materials. Therefore projects can be done in clean, quick and efficient way.

REFORMAS O RENOVACION INTERIOR DE ESPACIOS comerciales, residenciales, sanitarios, culturales, instalaciones deportivas u hoteles entre otros. El fino espesor del material permite la colocación sobre materiales ya existentes permitiendo realizar los proyectos de forma limpia, rápida y eficaz.

Size Formato	Piece Pieza		Crate Content Contenido del cajón				Crate Cajón	Total Weight Peso Total	Container/Pallet	Container m²/Sqm
	Sqm/Pcs m²/Pieza	Kg/Piece Kg/Pieza	Pcs/Crate Pzas/Cajón	Sqm/Crate m²/Crate	Kg/Crate Kg/Cajón					
260 x 120 cm. mate/matt 6mm.	3,12	45,5	21	65,52	956	100	1.056	12	786,24	
260 x 120 cm. polished/pulido 7mm.	3,12	52	18	56,16	936	100	1.036	12	673,92	

Crate size: 272 cm. x 133 cm. x 36 cm.
120 x 260 cm. - 6 mm.

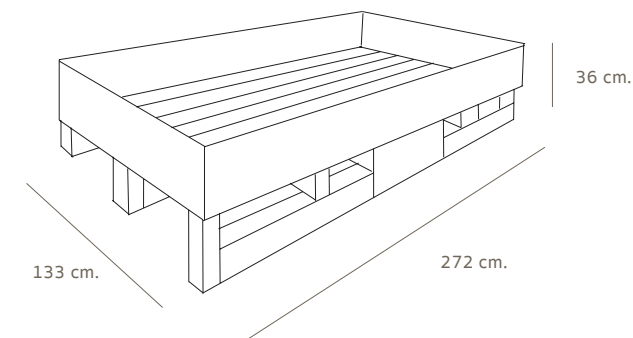

BRANCHES, DOORS, ISLES AND COUNTERTOPS COVERING.
RECUBRIMIENTO DE BANCADAS, PUERTAS, ISLAS Y ENCIMERAS de cocina y/o baño.



FURNITURE and other decoration pieces for indoor and outdoor.
MOBILIARIO auxiliar para interior y exterior y otros tipos de elementos decorativos para el hábitat.



VENTILATED FAÇADE

The ventilated façade or double-skin facade is a system of building consisting of two skins, or facades, placed in such a way that air flows in the intermediate cavity. The ventilation of the cavity can be natural, fan supported or mechanical. Apart from the type of the ventilation inside the cavity, the origin and destination of the air can differ depending mostly on climatic conditions, the use, the location, the occupational hours of the building and the HVAC strategy.

Several types of ventilated or double-skin façade have been developed for 6mm. porcelain tiles. Although ELAM porcelain tiles can be used in any of such systems they have been tested and approved for the use of the following ones:

The Vista CLF-40 Fixing System is a self-supporting Aluminium and Stainless Steel metal substructure kit for ventilated facades and designed for 6mm ELAM porcelain tiles.

The system is composed of support and retention brackets, vertical profiles and staples on which the cladding rests, all in high quality Aluminium T5 6063.

By means of the supporting and retention brackets or separators, a correct planimetry of the vertical profiles is achieved, thus correcting any possible deviations from the original face of the façade to be covered.

The staples used to support the weight of the ceramic panels are made of aluminium and lacquered from the RAL of the porcelain tile, incorporating an EPDM bushing to absorb any expansion of the structure.

Once fitted, the clamp can be slid vertically along the profile, thus facilitating its installation. Finally, the clips are screwed to the vertical profile by means of self-drilling stainless steel screws.

In order to favour the dimensional stability of the system, an elastic adhesive cord is applied along the vertical profile, which ensures the correct positioning of the chosen panels, improving the system's responses to pressure, wind suction and gravitational loads, thus absorbing the derived vibrations and thus avoiding possible movements.

FACHADAS VENTILADAS

La fachada ventilada o trasventilada es un sistema constructivo de cerramiento exterior constituido por una hoja interior, una capa aislante, y una hoja exterior no estanca. Este tipo de fachada por lo general permite acabados duraderos y de gran calidad, y ofrece buenas prestaciones térmicas.

Existen diferentes tipos de sistemas de fachada ventilada desarrollados para el uso de porcelánico de 6mm. Las láminas ELAM pueden emplearse en cualquiera de estos sistemas. No obstante, han sido testadas y homologadas para el uso de los siguientes sistemas:

El Sistema CLF-40 de fijación Vista, es un kit de subestructura metálica de aluminio y acero Inoxidable auto portante para fachadas ventiladas apto para las láminas de ELAM de 6mm de espesor.

El sistema está compuesto por ménsulas de sustentación y retención, perfiles verticales y grapas sobre las que se apoya el aplacado, todo en Aluminio T5 6063 de alta calidad.

Por medio de las ménsulas o separadores de sustentación y retención se consigue una correcta planimetría de los perfiles verticales, corrigiendo así las posibles desviaciones del paramento original de la fachada a recubrir.

Las grapas encargadas de soportar el peso de los paneles cerámicos están fabricadas en aluminio y lacadas del mismo RAL que la lámina porcelanica, incorporan un casquillo de EPDM para absorber las posibles dilataciones de la estructura.

Una vez encajada la grapa se puede deslizar en dirección vertical a lo largo del perfil facilitando así su instalación. Finalmente las grapas son atornilladas al perfil vertical por medio de tornillería auto taladrante de acero inoxidable.

Para favorecer la estabilidad dimensional del sistema se aplica un cordón del adhesivo elástico a lo largo del perfil vertical, que asegura el correcto posicionamiento de los paneles escogidos mejorando las respuestas del sistema a las cargas de presión, succión de viento y gravitatorias, absorbiendo así las vibraciones derivadas y evitando con ello los posibles movimientos.



VENTILATED FAÇADE

The XL-45 Hidden Fixation System is also a self-supporting Aluminum and Stainless Steel metal substructure kit suitable for ELAM porcelain tiles with the following features:

- Innovative design of discontinuous longitudinal anchors located on the back of the tile, with double groove at 45° in dovetail, which allow a union of the fixing elements to ELAM sheets to be 100% MECHANICAL. The system is designed to be installed only with this type of fixing, however its geometry allows the application of a structural adhesive, offering a safety bonus through a combined fixing system (mechanical-chemical).
- It has a SELF-COMPENSING system by means of stainless steel compression springs, which allow to assimilate the deformations due to the expansion of the substructure, in addition these springs contribute to support the own weight of ELAM sheets.
- Its regulation mechanisms achieve a perfect levelling of the tile as well as the perfect support of all the elements that compose it, thus obtaining an equitable distribution of these loads, making the installation of the system can be carried out in a simple, efficient and above all safe way.

FACHADAS VENTILADAS

El Sistema XL-45 de Fijación Oculta, es también un kit de subestructura metálica de aluminio y acero Inoxidable apto para las láminas de ELAM y cuyas características principales son:

- Innovador diseño de anclajes longitudinales discontinuos ubicados en el dorso de la lámina porcelánica, de doble ranura a 45° en cola de milano, las cuales permiten una unión de los elementos de fijación a la lámina ELAM de forma 100% MECANICA. El sistema está concebido para ser instalado únicamente con este tipo de fijación, no obstante su geometría permite la aplicación de un adhesivo estructural, ofreciendo un plus de seguridad mediante un sistema de fijación combinado (mecánico-químico).
- Posee un sistema AUTOCOMPENSANTE mediante resortes de compresión de acero inoxidable, los cuales permiten asimilar las deformaciones por dilatación de la subestructura, además dichos resortes contribuye a soportar el peso propio de las piezas de ELAM.
- Sus mecanismos de regulación logran una perfecta nivelación de la pieza así como del perfecto apoyo de todos los elementos que lo componen, obteniendo así un reparto equitativo de dichas cargas, haciendo que la instalación del sistema se pueda realizar de una manera sencilla eficaz y ante todo segura.



Limpieza y mantenimiento

Cleaning and maintenance

ELAM

ELAM slabs are easy to clean. However, some measures should be taken in order to achieve the optimal result. It is essential to test the product previously in one side of the sheet in order to check the product does not alter the surface.

It is highly recommended to clean the surface during the installation of the material. It is necessary to remove polluting agents such as cement coatings or mortar manually. If cements and mortar stains are not removed on the initial phase they can affect to the future maintenance.

For vast areas, cleaning using mechanical brush with soft discs is recommended.

Cement, lime scale, grout and mortar stains can be removed using descaling products. Instructions of the manufacturers of such products should be followed. After the use of chemical products, the use of abundant water to rinse the surface is recommended.

Epoxy products stains should be removed during the installation as soon as possible using a sponge and abundant and clean water. Afterwards, cleaning with an alkaline detergent should be done and instructions of the manufacturer of the alkaline detergent should be followed.

SPECIAL SUGGESTIONS FOR POLISHED MATERIALS

Polished materials are highly predisposed to the appearance of stains. This is due to the small micro-pores which are originated during the polishing process. Likewise, polished materials do not tolerate high concentration acids and alkalis such as hydrochloric acid, lactic acid and potassium hydroxide. Therefore, low concentration acids or household cleaning products are recommended.

Las láminas ELAM se limpian con mucha facilidad. No obstante, se recomienda tomar algunas medidas para conseguir un óptimo resultado. Es importante realizar una prueba previa en un lado de la superficie para comprobar que el producto no daña la lámina.

Se recomienda siempre una limpieza durante la instalación, eliminando todos los agentes contaminantes de la superficie. Si estos no se eliminan en la fase previa de limpieza, pueden afectar posteriormente al resto del mantenimiento.

En el caso de las grandes superficies, se recomienda la limpieza con el uso de cepillos mecánicos con discos suaves.

Los residuos de cemento, cal, lechada y mortero pueden eliminarse con el uso de desincrustantes específicos y siempre siguiendo las recomendaciones del fabricante del mismo. Tras el uso de productos químicos, se recomienda el aclarado con agua abundante.

Los residuos de productos epóxicos deben eliminarse con la ayuda de una esponja y agua abundante durante la instalación. Posteriormente, se recomienda una limpieza más a fondo con detergentes alcalinos.

Para un buen mantenimiento del pavimento, se aconseja el uso de agua abundante y un detergente neutro de un alto poder limpiador. En los casos de suciedad intensa e incrustada, siga las instrucciones de un profesional que podrá sugerirle el producto más indicado.

RECOMENDACIONES ESPECIALES PARA EL MATERIAL PULIDO

El material pulido tiene mayor predisposición a la aparición de manchas debido a los pequeños micro-poros que se originan durante el proceso de pulido. Asimismo, los pulidos no toleran los ácidos y álcalis de alta concentración tales como el ácido clorhídrico, ácido láctico e hidróxido potásico. Por lo tanto, se recomienda para su mantenimiento, el uso de ácidos de baja concentración o productos domésticos de limpieza.

Sistema de nivelación

Levelling system

Autonivela la altura de Pavimentos y Revestimientos.

Get proper levelling between pieces to avoid air gaps on floor and wall tiles.



Fácil fijación y extracción de la prótesis.

Easy fixing and levelling of prosthesis.



Sistema que mejora y facilita la colocación de cerámica.

Easy System that improves the installation of tiles.



Consigue la nivelación de piezas deseada con un perfecto acabado.

Get an excellent levelling of pieces with a perfect finishing.

TARIFA SISTEMA DE NIVELACIÓN RATES LEVELLING SYSTEM

Tarifa sistema de nivelación

Retales levelling system



Kit: 100 calzos (1 mm.) +
100 cuñas + tenaza
Kit: 100 each. TR-106



Alicate para cerámica. 1 ud.
Plier with graduated scale. 1 unit. TR-72



Bolsas de cuñas 100 uds.
Wedge-base set. 100 units. TR-43



Bolsas de calzos TR-40
1 mm., 2mm. y 3mm. 100 uds.
Crosshead set
1mm., 2mm. and 3mm. 100 units.
Bolsas de calzos TR-76
1 mm., 2mm. y 3mm. 300 uds.
Crosshead set
1mm., 2mm. and 3mm. 300 units.







Reservados todos los derechos. No se permite la reproducción, total o parcial de ninguna parte de este libro en internet o sobre cualquier otro medio sin el permiso escrito de DILMUN EMPRESARIAL, S.L.

Los colores de este catálogo deben considerarse orientativos.

All rights reserved. Total or partial reproduction of this book, in internet or any other media, is prohibited unless written authorisation from DILMUN EMPRESARIAL, S.L.

Colours of this catalogue are considered illustrative.

www.etile.com

DILMUN EMPRESARIAL S.L.
Ctra. Pobla Tornesa, Vall d'Alba, km 4,
12192, Vilafamés, Castellón (Spain)