

2014/2015



opatocznno

— 1883 —



Pragniemy, aby nasze wnętrza były piękne, przyjemne i wyjątkowe. **Dążenie do piękna** stanowi motto marki Opoczno, tworzącej od ponad 130 lat kolekcje, które z jednej strony łączą światowy design, a z drugiej są spełnieniem oczekiwań konsumentów. W oparciu o aktualne światowe trendy we wzornictwie, co roku przygotowujemy nowe kolekcje, dzięki którym każde wnętrze może być niepowtarzalne.

Przy tworzeniu kolekcji marka Opoczno bazuje na dwóch podejściach – nowoczesnym designie oraz sprawdzonej klasycie. Kolekcje z linii **classic** czerpią inspirację z klasyki i stanowią dowód na to, że to co zostało dobrze zaprojektowane, staje się ponadczasowe. Domeną tej linii jest bezpieczna, stonowana kolorystyka, będąca idealnym tłem dla innych przedmiotów znajdujących się we wnętrzu. Kolekcje **modern** to połączenie odważniejszych, bardziej wyrazistych kolorów oraz mieszanki różnych materiałów, jak na przykład szkła i ceramiki, z prostym i nowoczesnym wzornictwem.

Dbałość o detale, najnowsze techniki zdobnicze, najwyższa jakość produktów oraz wyjście naprzeciw zmieniającym się potrzebom klientów, sprawiają, że nasze kolekcje znajdują coraz więcej zadowolonych odbiorców i zdobią coraz większą ilość polskich i zagranicznych domów.

Od kilku lat marka Opoczno otrzymuje prestiżowe nagrody Superbrands, które zaliczają ją do elitarnego grona najsilniejszych marek. Są to nagrody **Superbrands** i **Superbrands Created in Poland**, przyznawane nie tylko przez specjalistów z branży, ale przede wszystkim przez konsumentów. I to właśnie uznanie i zadowolenie naszych klientów cieszy nas najbardziej. Jeszcze raz dziękujemy za zaufanie.

We desire for our interiors to be beautiful, pleasant, and exceptional. **Striving for beauty** is the motto of the Opoczno brand, which for more than 130 years has been creating collections that on the one hand represent world-class design and on the other fulfil our consumers' expectations. Based on current world design trends, we prepare new collections every year, thanks to which every interior can be one-of-a-kind.

The creation of the Opoczno brand collections is based on two approaches: modern design and well-tested classics. Collections in the **classic** line draw inspiration from classic designs, and offer proof that truly good design work becomes timeless and never goes out of style. This line features safe, low-key colour schemes, providing an ideal background for other objects situated within an interior. The **modern** collections combine bolder, more distinctive colours, mixtures of different materials (for example glass and ceramic), and simple, modern designs.

Concern for details, the latest decorative technologies, the highest quality, and our efforts to stay on top of our customers' changing needs all mean that our collections are finding more and more satisfied buyers and decorating more and more Polish and foreign homes.

For several years, the Opoczno brand has been receiving prestigious awards, placing it among an elite group of the strongest brands. These are the **Superbrands** and **Superbrands Created in Poland** awards, which are given not only by specialists from the industry, but above all by consumers themselves. It is this appreciation from our customers, their satisfaction, that pleases us the most. We are grateful for the trust placed in us.

PŁYTKI CERAMICZNE CERAMIC TILES

Innowacyjna Technologia Smart Silver® Innovative Smart Silver® Technology ⁰¹⁰

Cechy produktów Product features ⁰¹²

new Uniwersalne dekoracje szklane Universal glass decorations ⁰²⁰

Łazienka Bathroom

modern

new Dusk ⁰³²

new Equinox ⁰³⁶

new Urban Mix ⁰⁴⁰

new Kando ⁰⁴⁸

Allwood ⁰⁵²

Amarante ⁰⁵⁶

Avangarde ⁰⁶⁰

new Basic Palette ⁰⁶⁴

new Creamy Touch ⁰⁷²

Damasco ⁰⁷⁶

new Early Pastels ⁰⁸⁰

Fargo ⁰⁸⁴

French Touch ⁰⁸⁸

Karoo ⁰⁹²

new Light Marble ⁰⁹⁶

Livingwood ¹⁰⁰

Metalic ¹⁰⁴

Black&White ¹⁰⁸

Capri ¹¹²

Cemento ¹¹⁶

Fusion ¹²⁰

Penne ¹²⁴

Soft Ornament ¹²⁶

Sunny Wood ¹³⁰

Baricello ¹³⁴

Calipso ¹³⁸

new Desert Storm ¹⁴²

Fiji ¹⁴⁶

Lorena ¹⁴⁸

new Sandy Wind ¹⁵²

new Sea Mist ¹⁵⁶

Zebrano ¹⁶⁰

Palette ¹⁶⁴

Colour Connection ¹⁶⁸

Crystal Palace ¹⁷²

Cuban Cube ¹⁷⁶

Inwencja ¹⁸⁰

classic

new Arkos ¹⁸⁶

new Daino ¹⁹⁰

new Yakara ¹⁹⁴

new Quartz ²⁰⁰

new Playa ²⁰⁴

Carrara ²⁰⁸

Sahara ²¹²

Lazio ²¹⁶

Naturale ²²⁰

Salonika ²²⁴

Organza ²²⁶

Vanilla Stone ²³⁰

Kuchnia Kitchen

modern

City Call ²³⁶

French Touch ²⁴⁰

Italian Fresco ²⁴⁴

Penne ²⁴⁸

Cuban Cube ²⁵⁰

Crystal Palace ²⁵⁴

Colour Connection ²⁵⁸

Inwencja ²⁶²

Aplauz ²⁶⁶

Montana ²⁶⁸

Salisa ²⁷⁰

classic

new Quartz ²⁷⁴

Organza ²⁷⁸

Field Blue ²⁸²

Morning Fog ²⁸⁶

Jesień ²⁸⁸

Madera ²⁹⁰

Sagra ²⁹²

Salon, Taras Living room, Terrace

modern

- Dry River ²⁹⁶
- new** Dusk ³⁰⁴
- new** Equinox ³⁰⁸
- new** Urban Mix ³¹²
- new** Legno Moderno ³²⁰
- Artwood ³²⁴
- new** Creamy Touch ³²⁸
- Damasco ³³²
- new** Early Pastels ³³⁶
- Fargo ³⁴⁰
- new** Kando ³⁴⁴
- Lazzaro ³⁴⁸
- new** Light Marble ³⁵²
- new** Moondust ³⁵⁶
- Visione ³⁶²
- Allwood ³⁶⁶
- Karoo ³⁷⁰
- Livingwood ³⁷⁴
- Deckwood ³⁷⁸
- Forest Touch ³⁸⁰
- Scandic Life ³⁸⁴
- Silent Stone ³⁸⁸
- Bazalto ³⁹²
- new** Basic Palette ³⁹⁶
- Kallisto ⁴⁰⁰
- Hyperion ⁴⁰⁶
- Milton ⁴¹⁰

classic

- new** Arkos ⁴¹⁴
- new** Daino ⁴¹⁸
- new** Yakara ⁴²²
- new** Quartz ⁴²⁸
- new** Playa ⁴³²
- new** Legno Rustico ⁴³⁶
- Carrara ⁴⁴⁰
- Lazio ⁴⁴⁴
- Sahara ⁴⁴⁸
- Spazio ⁴⁵²
- Naturale ⁴⁵⁶
- Nodo ⁴⁶⁰
- Misty Stone ⁴⁶⁴
- Mojave ⁴⁶⁸

Clinker Klinkier

- Solar ⁴⁷⁴
- Simple ⁴⁸⁰
- Shadow ⁴⁸⁶

CERAMIKA, MEBLE, WANNY CERAMICS, FURNITURE, BATHTUBS

- Bilbao ⁴⁹⁴
- Kioto ⁵⁰²
- Malmo ⁵⁰⁸

Informacje techniczne

Technical Information ⁵¹⁴

A

Allwood 052, 366
Amarante 056
Aplauz 266
Arkos 186, 414
Artwood 324
Avangarde 060

B

Baricello 134
Basic Palette 064, 396
Bazalto 392
Bilbao 494
Black&White 108

C

Calipso 138
Capri 112
Carrara 208, 440
Cemento 116
City Call 236
Colour Connection 168, 258
Creamy Touch 072, 328
Crystal Palace 172, 254
Cuban Cube 176, 250

D

Daino 190, 418
Damasco 076, 332
Deckwood 378
Desert Storm 142
Dry River 296
Dusk 032, 304

E

Early Pastels 080, 336
Equinox 036, 308

F

Fargo 084, 340
Field Blue 282
Fiji 146
Forest Touch 380
French Touch 088, 240
Fusion 120

H

Hyperion 406

I

Inwencja 180, 262
Italian Fresco 244

J

Jesień 288

K

Kallisto 400
Kando 048, 344
Karoo 092, 370
Kioto 502

L

Lazzaro 348
Lazio 216, 444
Legno Moderno 320
Legno Rustico 436
Light Marble 096, 352
Livingwood 100, 374
Lorena 148

M

Madera ²⁹⁰
Malmo ⁵⁰⁸
Metalic ¹⁰⁴
Milton ⁴¹⁰
Misty Stone ⁴⁶⁴
Mojave ⁴⁶⁸
Montana ²⁶⁸
Moondust ³⁵⁶
Morning Fog ²⁸⁶

N

Naturale ^{220, 456}
Nodo ⁴⁶⁰

O

Organza ^{226, 278}

P

Palette ¹⁶⁴
Penne ^{124, 248}
Playa ^{204, 432}

Q

Quartz ^{200, 274, 428}

S

Sagra ²⁹²
Sahara ^{212, 448}
Salisa ²⁷⁰
Salonika ²²⁴
Sandy Wind ¹⁵²
Scandic Life ³⁸⁴
Sea Mist ¹⁵⁶
Shadow ⁴⁸⁶
Silent Stone ³⁸⁸
Simple ⁴⁸⁰
Soft Ornament ¹²⁶
Solar ⁴⁷⁴
Spazio ⁴⁵²
Sunny Wood ¹³⁰

U

Urban Mix ^{040, 312}

V

Vanilla Stone ²³⁰
Visione ³⁶²

Y

Yakara ^{194, 422}

Z

Zebrano ¹⁶⁰

PŁYTKI
CERAMICZNE

CERAMIC
TILES

Ag+

SMART
SILVER®
TECHNOLOGY



p#
010
011

OCHRONA ANTYBAKTERYJNA ANTI-BACTERIAL PROTECTION

Nowatorski sposób na eliminację 99,8% bakterii

Smart Silver® to technologia opatentowana przez amerykańską firmę NanoHorizons Inc. w Pensylwanii. Została ona opracowana na bazie wyników wieloletnich badań naukowych, prowadzonych w dziedzinie ochrony antybakteryjnej.

Korzystając z efektów tych badań oraz udostępnionej technologii, wdrożyliśmy innowacyjne rozwiązanie, które bazuje na bakteriobójczym działaniu srebra. Podczas procesu szkliwienia wykorzystujemy dodatkowo jony srebra, które oprócz właściwości bakteriobójczych zabijają także szkodliwe dla zdrowia grzyby oraz pleśń. Wytworzona powłoka eliminuje nawet do 99,8% bakterii i grzybów. Warstwa ta jest odporna na ścieranie, nie zanika ani nie zużywa się i zachowuje swoje właściwości przez cały okres użytkowania płytek.

A revolutionary way to eliminate 99.8% of all bacteria

Smart Silver®, an advanced technology patented by the US-based company NanoHorizons in Pennsylvania, was developed through years of scientific research on antibacterial protection.

We have harnessed these advances to create innovative products utilizing the bactericidal properties of silver. During the glazing process we use silver cations, which have strong anti-bacterial properties and also eliminate harmful fungi and mold. The coating so created can eliminate even as much as 99.8% of bacteria and fungi. The tiles are also highly resistant to abrasion, wear, and fading, and retain these properties throughout their lifespans.

Powierzchnia płytki po użyciu środka bakteriobójczego

Tile surface to which a bactericidal solution has been applied

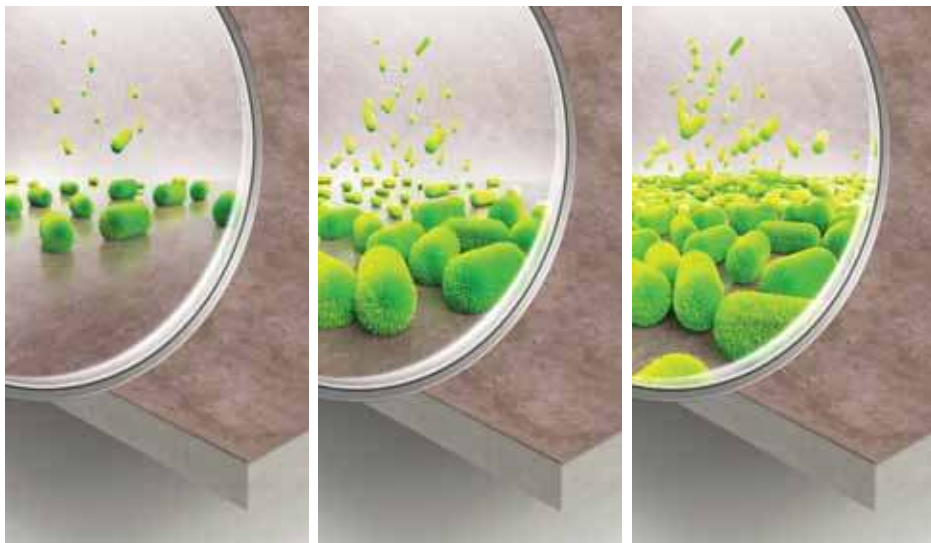

1 DZIEŃ / 1 DAY
po zastosowaniu
środka
bakteriobójczego

after the application
of a bacterial
disinfectant

1 TYDZIEŃ / 1 WEEK
po zastosowaniu
środka
bakteriobójczego

after the application
of a bacterial
disinfectant

2 TYGODNIE / 2 WEEKS
po zastosowaniu
środka
bakteriobójczego

after the application
of a bacterial
disinfectant

Płytki pokryte szklivem SMART SILVER®

Tiles covered with the SMART SILVER® glaze

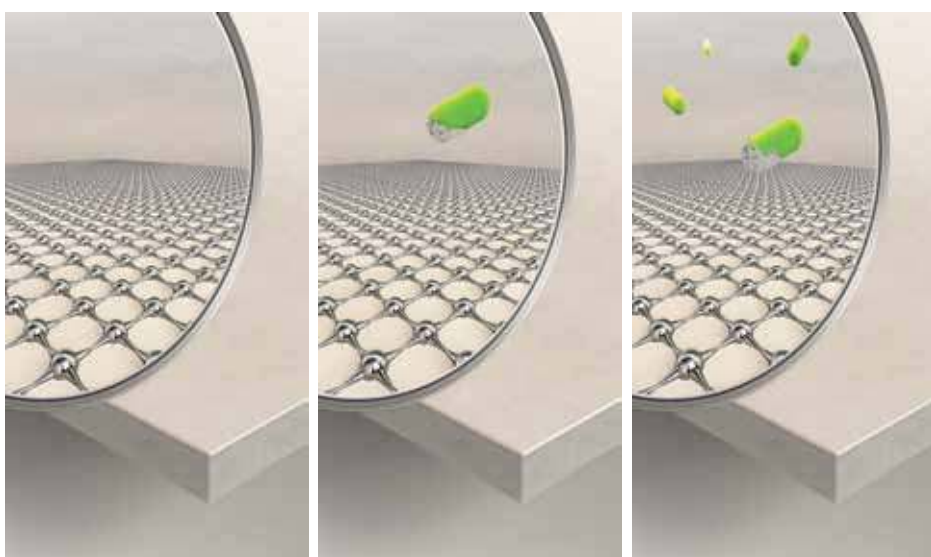

1 DZIEŃ / 1 DAY
po położeniu
płytek

after tile
installation

1 TYDZIEŃ / 1 WEEK
po położeniu
płytek

after tile
installation

2 TYGODNIE / 2 WEEKS
po położeniu
płytek

after tile
installation

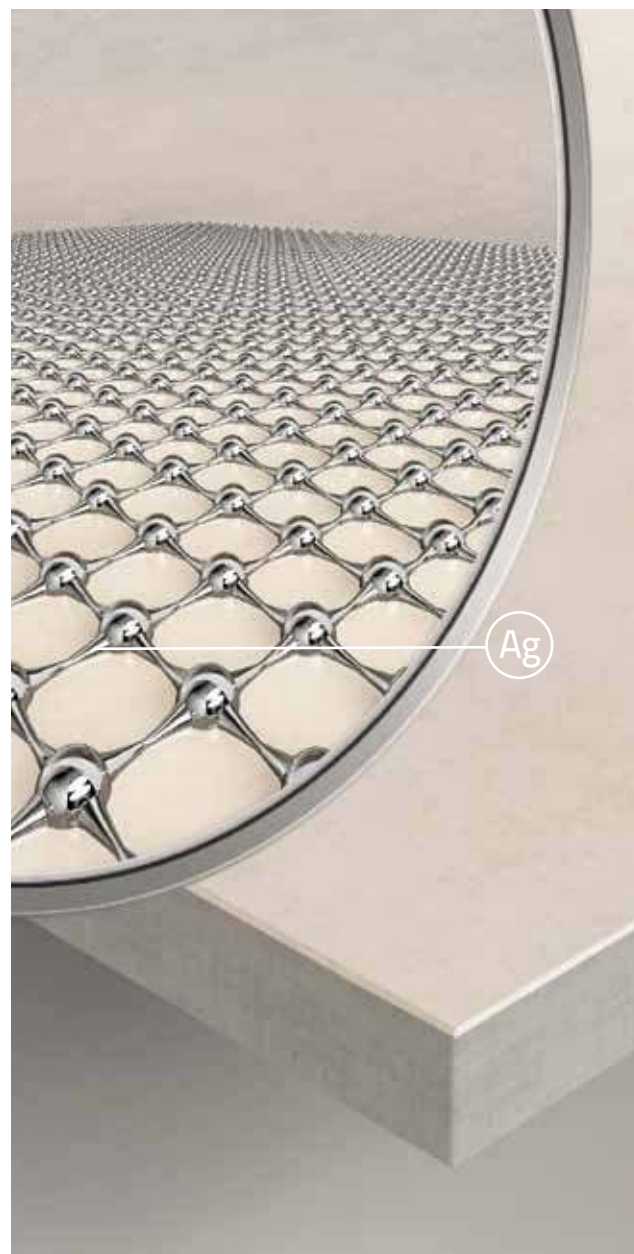

SMART SILVER® TECHNOLOGY
eliminuje bakterie i zapewnia bezpieczną
higieniczną powierzchnię.

SMART SILVER® TECHNOLOGY
eliminates bacteria and ensures a safe, hygienic
surface.



grupa 1

GRESY NIESZKLIWIONE

UNGLAZED PORCELAIN TILES

Gres nieszkliwiony charakteryzuje się jednorodną, zwartą strukturą w całej swojej grubości. Dzięki temu, nawet intensywne wieloletnie użytkowanie nie powoduje zmiany barwy i struktury płytek. Twardość gresu nieszkliwionego jest zbliżona do twardości granitu, co zapewnia mu dużą odporność na ścieranie, a dzięki niskiej nasiąkliwości wodnej, jest mrozoodporny. Zastosowane materiały oraz technologia produkcji powodują, że gres nieszkliwiony może być stosowany na powierzchniach o najwyższym natężeniu ruchu.

Unglazed porcelain tiles are characterized by a dense uniform structure throughout the body of the tile. Even when subjected to intensive use for many years, such tiles do not change their color or structure and their hardness is similar to that of granite, which makes them highly resistant to abrasion. Low water absorption, in turn, translates into frost resistance. The materials and technologies applied in the production of unglazed porcelain tiles make them suitable for surfaces with even the heaviest traffic.

g1



grupa 2

GRESY SZKLIWIONE

GLAZED PORCELAIN TILES

Gres szklwiony zachowując większość zalet gresu nieszkliwionego, ma przy tym niemal nieograniczone możliwości wzornicze. Dzięki cienkiej, ozdobnej warstwie szkliwa może mieć dowolny kolor, wzór a nawet strukturę. Szkliwo zabezpiecza również przed trwałym zabrudzeniem podczas użytkowania. Gres szklwiony o najwyższej klasie ścieralności może być stosowany nawet w miejscach, gdzie natężenie ruchu jest bardzo wysokie. Jest idealny do zastosowania w miejscu, gdzie wysokie walory estetyczne płytek powinny łączyć się z najwyższymi parametrami technicznymi.

In addition to retaining most of the advantages of unglazed surfaces, glazed porcelain tiles provide virtually endless design possibilities. A thin layer of decorative glaze may come in any color, pattern, and texture. Glazing also protects tiles from permanent staining. Glazed porcelain tiles with the highest wear resistance ratings may be used even in areas with very intensive traffic. They are perfectly suited to spaces requiring finishes that combine esthetic design and top-notch technical ratings.

g2

grupa 3

PŁYTKI ŚCIENNE

WALL TILES

Powierzchnia płytek ściennych pokryta jest cienką warstwą szkliwa, co zabezpiecza je przed zaplamieniem, ułatwia utrzymanie w czystości oraz zapewnia maksymalną higienę podczas użytkowania. Gwarantuje też zachowanie pierwotnego koloru w całym okresie eksploatacji. Dzięki nieograniczonym możliwościom technologicznym zdobienia można uzyskać płytki praktycznie w każdym kolorze i o dowolnym wzornictwie oraz o różnym wykończeniu powierzchni: błyszczące, matowe, strukturalne.

Wall tiles are covered with a thin layer of glaze to ensure stain resistance, easy cleaning, and maximum hygiene. Such tiles will retain their original color throughout their useful life. Offering unlimited decoration possibilities, wall tiles are available in practically all colors, motifs, and surface finishes: glossy, matte, and textured.

g3



CECHY PRODUKTÓW
PRODUCT FEATURES

WYJĄTKOWA ESTETYKA UNIQUE ESTHETICS

MODULARNOŚĆ MODULAR FIT

Uzupełniające się formaty płytek z tej samej kolekcji można łączyć ze sobą z zastosowaniem stałej szerokości fug. Dzięki różnorodności wymiarów płytek, zwiększają się możliwości tworzenia unikalnych kompozycji.

Multi-format tiles from the same collection may be combined, using the same grout joint width. Various size options open up greater possibilities for creating unique compositions.

g1 g2



DRUK CYFROWY DIGITAL PRINTING

Nowoczesna technologia druku cyfrowego umożliwia precyzyjne odwzorowanie na powierzchni płytek grafiki naturalnych materiałów, takich jak np. drewno czy kamień. Daje także możliwość wykonania dużej liczby płytek z niepowtarzającym się wzorem w ramach tej samej kolekcji, co znacznie podnosi estetykę pomieszczenia.

Modern digital print technologies can faithfully reproduce the graphics of natural materials such as wood and stone on the surface of tiles. They also make it possible to manufacture large amounts of tiles with unique motifs within the same collection, for beautifully designed rooms.

g2 g3

REKTYFIKACJA PERFECT EDGE SYSTEM

Rektyfikacja to proces przycinania i szlifowania krawędzi płytek, sterowany komputerowo. Dzięki temu otrzymujemy płytki o idealnych wymiarach. Pozwala to na zastosowanie fug o minimalnej szerokości, a co za tym idzie, jeszcze lepsze wyeksponowanie naturalnego piękna wzoru i faktury płytek oraz uzyskanie efektu jednolitej powierzchni.

Through a computer-controlled process of cutting and edge-grinding to produce tiles that are exactly the same size. Rectified tiles can be therefore installed with minimum grout joints to better highlight the natural beauty and texture of the tiles and achieve a seamless look.

g1

g2

g3



BARWIONA BAZA COLORED BODY

Zastosowanie podczas procesu produkcyjnego barwionej bazy, która może być dopasowana do tonacji szklawa, znacznie zwiększa estetykę płytek rektyfikowanych. Ich precyzyjnie sfazowane krawędzie mają identyczny kolor jak powierzchnia całej płytki.

Pigments added to the tile mixture ensure that the glaze color will match the color of the tile body, significantly improving the esthetics of rectified tiles. Precision-chamfered edges show coloring identical to the surface of the whole tile.

g1

g2



POLEROWANIE POLISHED SURFACE

Proces mechanicznego polerowania płytek powoduje, że ich powierzchnia jest idealnie gładka oraz błyszcząca, sprawiająca wrażenie lustrzanej. Ciekawa estetyka tych płytek prezentuje się wyjątkowo efektownie, zarówno na ścianach, jak i na podłogach. Płytki polerowane to również świetne uzupełnienie powierzchni, na której zastosowano płytki matowe.

Smooth and shiny, mechanically polished tiles are characterized by a mirror-like surface. Interesting design options add an exceptional elegance to both walls and floors. Polished tiles are also a great complement to settings incorporating tiles in matte finishes.

g1

g2

RÓŻNORODNE ZASTOSOWANIE VARIETY OF APPLICATIONS

ANTYPOŚLIZGOWOŚĆ SLIP RESISTANCE

Strukturalna lub pokryta granulatem powierzchnia płytek oprócz walorów estetycznych zapewnia doskonałą ochronę antypoślizgową. Przekłada się ona na bezpieczeństwo i pewność użytkowania płytek w różnych warunkach. Możemy stosować je również bez obaw w miejscach o zwiększonym natężeniu ruchu. Skuteczność antypoślizgowa płytek OPOCZNO została potwierdzona normą DIN 51130.

In addition to esthetic values, textured or granulated tile surfaces provide excellent slip resistance, which makes such tiles reliable and safe in different conditions. Slip resistant tiles can be installed in high-traffic areas. The slip resistance of OPOCZNO tiles is compliant with DIN 51130 standards.

g1 g2



OGRZEWANIE PODŁOGOWE FLOOR HEATING READY

Płytki gresowe dzięki bardzo niskiemu współczynnikowi cieplnej rozszerzalności liniowej doskonale sprawdzają się w pomieszczeniach z ogrzewaniem podłogowym. Współczynnik ten dla gresu szklwionego i nieszkliwionego Opczno jest zgodny z wymaganiami normy PN-EN ISO 10545-8.

Porcelain tiles have very low linear thermal expansion coefficients, so they are perfectly suited for interiors with floor heating. Linear thermal expansion coefficients for Opczno's glazed and unglazed porcelain tiles are consistent with the requirements of the PN-EN ISO 10545-8 standard.

g1 g2





WEWNĄTRZ I NA ZEWNĄTRZ INDOOR & OUTDOOR

Bardzo niska nasiąkliwość wodna oraz związana z tym parametrem mrozoodporność i wysoka wytrzymałość mechaniczna powoduje, że gres jest najbardziej uniwersalnym materiałem wykończeniowym. Płytki gresowe nadają się zarówno do wnętrza, jak i na zewnątrz. Równie dobrze sprawdzą się na tarasie i elewacji, jak też w łazience, kuchni czy salonie.

Low water absorption rates and the related high resistance to frost and mechanical wear make porcelain tiles the most universal finishing material for both interior and exterior settings. They are equally well-suited to terraces and building façades as well as bathrooms, kitchens, and living rooms.

g1

g2

ŚCIANY I PODŁOGI

WALLS & FLOORS

Uniwersalne wzornictwo, nowe techniki zdobienia oraz doskonałe parametry techniczne umożliwiają stosowanie płytek gresowych, zarówno na ścianach, jak i na podłogach. Gres staje się materiałem uniwersalnym, który można stosować praktycznie na każdej powierzchni i we wszystkich rodzajach pomieszczeń.

Universal design combined with new decoration techniques and top technical ratings make porcelain tiles suitable for both walls and floors. Porcelain tiles are universal materials that can be installed practically on any surface and in any setting.

g1

g2

PODWYŻSZONA TRWAŁOŚĆ GREATER DURABILITY



p#
018
019

WYTRZYMAŁOŚĆ EXTRA STRONG

Płytki gresowe, dzięki wyjątkowo niskiej porowatości oraz procesowi formowania ich pod bardzo dużym ciśnieniem, cechują się doskonałymi parametrami wytrzymałościowymi. Podwyższona odporność mechaniczna daje możliwość stosowania ich w pomieszczeniach, w których występują ponadprzeciętne obciążenia. Wytrzymałość na zginanie oraz siła łamiąca spełniają wymagania normy PN-EN ISO 10545-4.

Formed under very high pressure, porcelain tiles are characterized by exceptionally low porosity and excellent resistance. Greater mechanical resistance means that porcelain tiles tolerate high loads. Requirements of the bending and breaking strength are defined in the standard PN-EN ISO 10545-4.

g1

g2

MROZODPORNOŚĆ FROST RESISTANCE

Wszystkie gresy naszej produkcji cechują się minimalną wchłaniałością wody i niską porowatością, dzięki czemu są odporne nawet na skrajnie niskie temperatury. Można je stosować praktycznie w każdych warunkach pogodowych. Mrozoodporność gresu Opoczno potwierdzona jest badaniem wg normy PN-EN ISO 10545-12.

All porcelain tiles produced by Opoczno are characterized by minimal water absorption rates and low porosity, which makes them resistant even to extremely low temperatures. Such tiles can be used in practically any weather conditions. The frost resistance of Opoczno's porcelain tiles has been confirmed by tests consistent with the PN-EN ISO 10545-12 standard.

g1

g2



HP HIGH
PERFORMANCE

NAJWYŻSZE PARAMETRY HIGH PERFORMANCE

Płytki szkliwione o najwyższej, 5 klasie ścieralności oraz gresy nieszkliwione i zdobione w masie spełniają najwyższe wymagania jakościowe. Można je stosować na powierzchniach o wyjątkowo dużym natężeniu ruchu oraz wymagających wysokiej odporności na obciążenia.

Glazed tiles in the highest, fifth abrasion class and the unglazed porcelain tiles meet the highest quality requirements. They can be used on surfaces with extremely high traffic and requiring high resistance to load.

6
YEAR
WARRANTY

GWARANCJA WARRANTY

Wszystkie płytki Opoczno objęte są 6-letnią gwarancją. Gwarantujemy zachowanie parametrów technologicznych i użytkowych określonych w normie PN-EN 14411.

All Opoczno tiles come with a 6-year warranty and are guaranteed to retain their technical properties, as defined in the standard PN-EN 14411.

g1 **g2** **g3**



ZDOBIONE W MASIE FULL BODY DECORATION

Zastosowanie w płytkach nieszkliwionych jednolitej, barwionej masy w całym przekroju płytki powoduje, że otrzymujemy bardzo twarde i odporne na zarysowania produkty. Wytrzymuje on ponadprzeciętne obciążenia występujące podczas użytkowania. Płytki wykonane w tej technologii mogą być stosowane w miejscach o bardzo dużym natężeniu ruchu, szczególnie w obiektach użyteczności publicznej, jak również w obiektach przemysłowych: halach produkcyjnych, magazynach, itp.

Using a uniform, colored mixture for unglazed tiles yields a very hard and scratch-resistant product, able to withstand extreme loads. Tiles manufactured using this technology can be used in areas with very high traffic, especially public-access spaces, as well as at industrial facilities: factory floors, warehouses, etc.

g1

NIE WYMAGA IMPREGNACJI NO IMPREGNATION REQUIRED

Matowy gres nieszkliwiony naszej produkcji jest odporny na zabrudzenia, nie wymaga impregnacji.

Opoczno's matte unglazed porcelain tiles are resistant to staining and require no impregnation.

g1

p#
020
021





new

Universal glass decorations

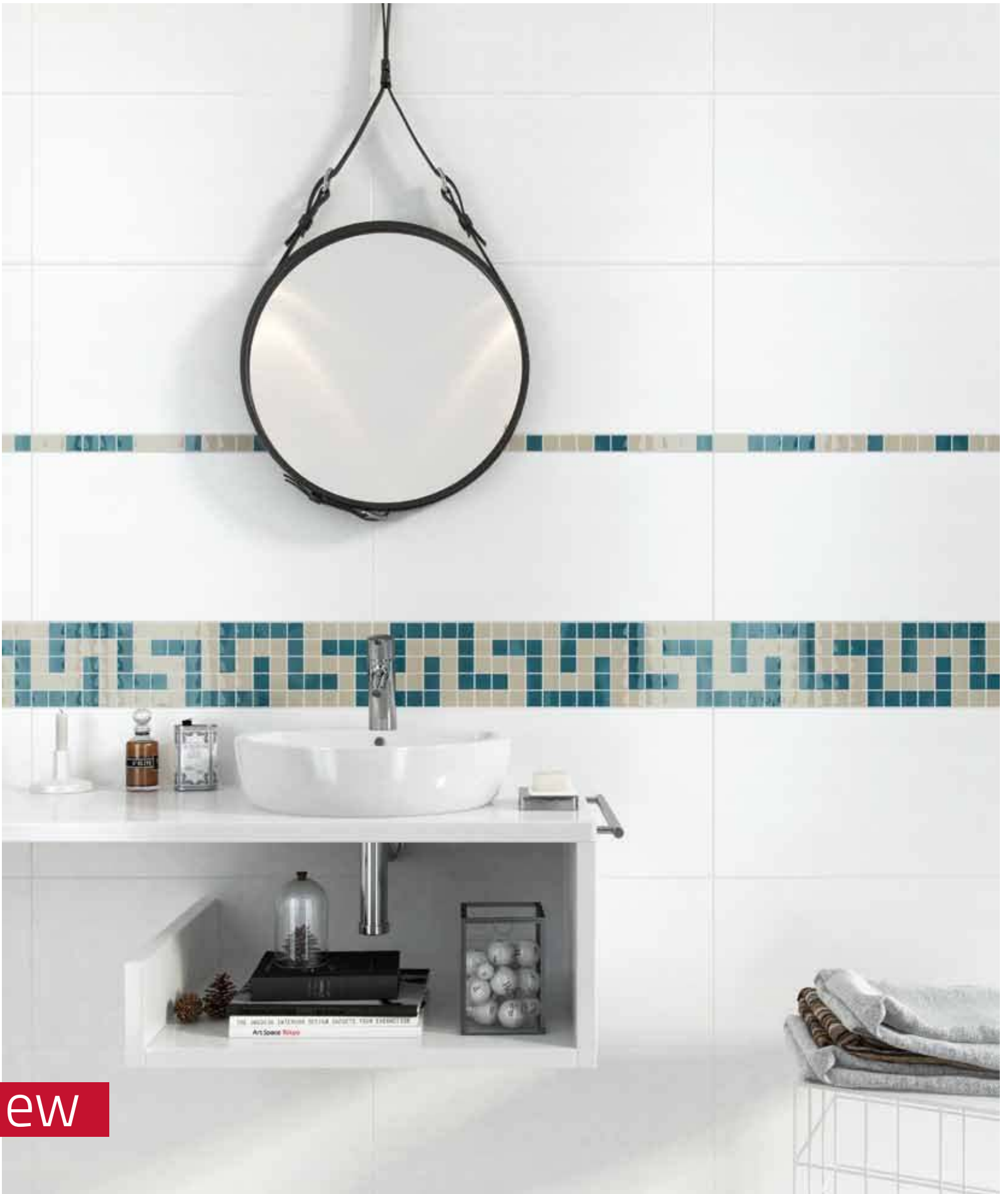

p#
022
023

new

Universal glass decorations

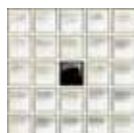

GLASS white/black
mosaic A NEW
14,8 x 14,8
OD660-116

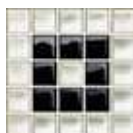

GLASS white/black
mosaic B NEW
14,8 x 14,8
OD660-117



GLASS white/black
mosaic C NEW
14,8 x 14,8
OD660-118



GLASS white/black
mosaic D NEW
14,8 x 14,8
OD660-119



GLASS silver/red
mosaic A NEW
14,8 x 14,8
OD660-120



GLASS silver/red
mosaic B NEW
14,8 x 14,8
OD660-121

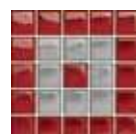

GLASS silver/red
mosaic C NEW
14,8 x 14,8
OD660-122

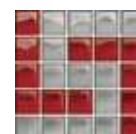

GLASS silver/red
mosaic D NEW
14,8 x 14,8
OD660-123

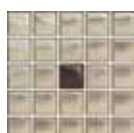

GLASS beige/brown
mosaic A NEW
14,8 x 14,8
OD660-124

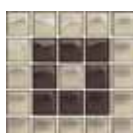

GLASS beige/brown
mosaic B NEW
14,8 x 14,8
OD660-125

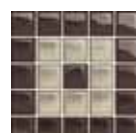

GLASS beige/brown
mosaic C NEW
14,8 x 14,8
OD660-126



GLASS beige/brown
mosaic D NEW
14,8 x 14,8
OD660-127



GLASS azure/dark beige
mosaic A NEW
14,8 x 14,8
OD660-128



GLASS azure/dark beige
mosaic B NEW
14,8 x 14,8
OD660-129



GLASS azure/dark beige
mosaic C NEW
14,8 x 14,8
OD660-130



GLASS azure/dark beige
mosaic D NEW
14,8 x 14,8
OD660-131





p#
024
025

new

Universal glass decorations



GLASS white inserto
9,9 x 29,7
OD660-104



GLASS white inserto 9,9 x 9,9
OD660-112



GLASS black inserto
9,9 x 29,7
OD660-100



GLASS black inserto 9,9 x 9,9
OD660-108



GLASS black inserto
20 x 20
OD660-096



GLASS silver inserto
9,9 x 29,7
OD660-105



GLASS silver inserto 9,9 x 9,9
OD660-113



GLASS red inserto
9,9 x 29,7
OD660-101



GLASS red inserto 9,9 x 9,9
OD660-109



GLASS red inserto
20 x 20
OD660-097



GLASS beige inserto
9,9 x 29,7
OD660-106



GLASS beige inserto 9,9 x 9,9
OD660-114



GLASS azure inserto
9,9 x 29,7
OD660-102



GLASS azure inserto 9,9 x 9,9
OD660-110



GLASS azure inserto
20 x 20
OD660-098



GLASS dark beige inserto
9,9 x 29,7
OD660-107



GLASS dark beige inserto 9,9 x 9,9
OD660-115



GLASS brown inserto
9,9 x 29,7
OD660-103



GLASS brown inserto 9,9 x 9,9
OD660-111



GLASS brown inserto
20 x 20
OD660-099



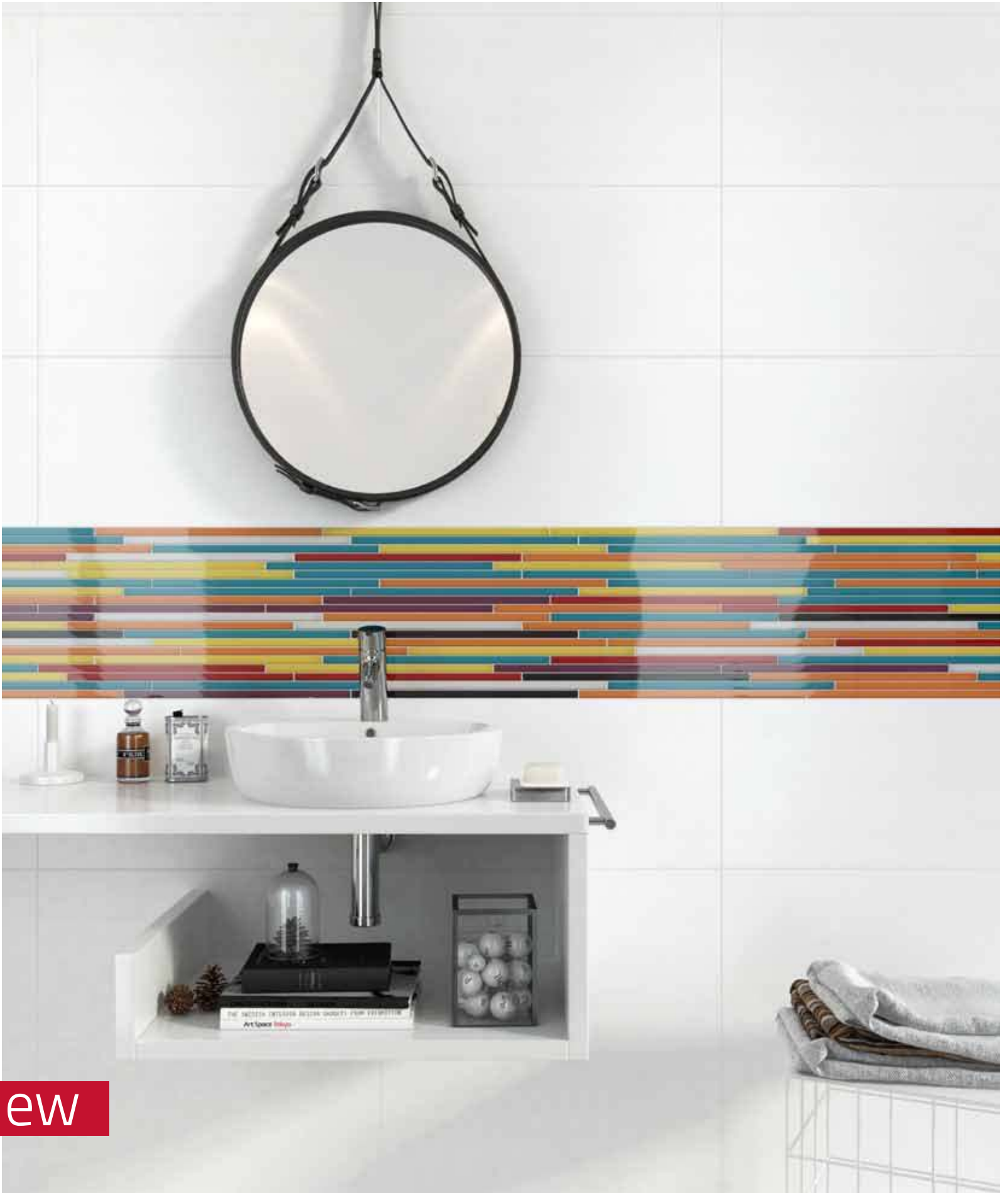

p#
026
027

new

Universal glass decorations



GLASS turquoise border NEW 4,8 x 60
OD660-004



GLASS turquoise border NEW 2 x 60
OD660-020



GLASS turquoise border NEW 2 x 59,3
OD660-035



GLASS turquoise border NEW 2 x 50
OD660-051



GLASS turquoise border NEW 2 x 45
OD660-067



GLASS turquoise border NEW 1,5 x 40
OD660-083



GLASS light green border NEW 4,8 x 60
OD660-003



GLASS light green border NEW 2 x 60
OD660-019



GLASS light green border NEW 2 x 59,3
OD660-034



GLASS light green border NEW 2 x 50
OD660-050



GLASS light green border NEW 2 x 45
OD660-066



GLASS light green border NEW 1,5 x 40
OD660-082



GLASS azure border NEW 4,8 x 60
OD660-005



GLASS azure border NEW 2 x 60
OD660-021



GLASS azure border NEW 2 x 59,3
OD660-036



GLASS azure border NEW 2 x 50
OD660-052



GLASS azure border NEW 2 x 45
OD660-068



GLASS azure border NEW 1,5 x 40
OD660-084

Uniwersalne listwy szklane do płytek ceramicznych

Uniwersalne listwy szklane możesz łączyć również z kolekcjami wszystkich innych producentów płytek ceramicznych dostępnych na rynku.

Wybieraj spośród 6 formatów w 15 kolorach.

Universal glass borders for the ceramic tiles

Universal glass borders you can match also with other producers' ceramic tiles collections available on the market.

Choose from 6 formats in 15 colors.



GLASS white border NEW 4,8 x 60
OD660-009



GLASS white border NEW 2 x 60
OD660-025



GLASS white border NEW 2 x 59,3
OD660-040



GLASS white border NEW 2 x 50
OD660-056



GLASS white border NEW 2 x 45
OD660-072



GLASS white border NEW 1,5 x 40
OD660-088



GLASS silver border NEW 4,8 x 60
OD660-013



GLASS silver border NEW 2 x 60
OD660-029



GLASS silver border NEW 2 x 59,3
OD660-044



GLASS silver border NEW 2 x 50
OD660-060



GLASS silver border NEW 2 x 45
OD660-076



GLASS silver border NEW 1,5 x 40
OD660-092



GLASS black border NEW 4,8 x 60
OD660-010



GLASS black border NEW 2 x 60
OD660-026



GLASS black border NEW 2 x 59,3
OD660-041



GLASS black border NEW 2 x 50
OD660-057



GLASS black border NEW 2 x 45
OD660-073



GLASS black border NEW 1,5 x 40
OD660-089



GLASS beige border NEW 4,8 x 60
OD660-011



GLASS beige border NEW 2 x 60
OD660-027



GLASS beige border NEW 2 x 59,3
OD660-042



GLASS beige border NEW 2 x 50
OD660-058



GLASS beige border NEW 2 x 45
OD660-074



GLASS beige border NEW 1,5 x 40
OD660-090



GLASS dark beige border NEW 4,8 x 60
OD660-008



GLASS dark beige border NEW 2 x 60
OD660-024



GLASS dark beige border NEW 2 x 59,3
OD660-039



GLASS dark beige border NEW 2 x 50
OD660-055



GLASS dark beige border NEW 2 x 45
OD660-071



GLASS dark beige border NEW 1,5 x 40
OD660-087



GLASS brown border NEW 4,8 x 60
OD660-012



GLASS brown border NEW 2 x 60
OD660-028



GLASS brown border NEW 2 x 59,3
OD660-043



GLASS brown border NEW 2 x 50
OD660-059



GLASS brown border NEW 2 x 45
OD660-075



GLASS brown border NEW 1,5 x 40
OD660-091

p#
028
029

Universal glass decorations



GLASS yellow border NEW 4,8 x 60
OD660-002



GLASS yellow border NEW 2 x 60
OD660-018



GLASS yellow border NEW 2 x 59,3
OD660-033



GLASS yellow border NEW 2 x 50
OD660-049



GLASS yellow border NEW 2 x 45
OD660-065



GLASS yellow border NEW 1,5 x 40
OD660-081



GLASS orange border NEW 4,8 x 60
OD660-001



GLASS orange border NEW 2 x 60
OD660-017



GLASS orange border NEW 2 x 59,3
OD660-032



GLASS orange border NEW 2 x 50
OD660-048



GLASS orange border NEW 2 x 45
OD660-064



GLASS orange border NEW 1,5 x 40
OD660-080



GLASS red border NEW 4,8 x 60
OD660-016



GLASS red border NEW 2 x 60
OD660-031



GLASS red border NEW 2 x 59,3
OD660-047



GLASS red border NEW 2 x 50
OD660-063



GLASS red border NEW 2 x 45
OD660-079



GLASS red border NEW 1,5 x 40
OD660-095



GLASS heather border NEW 4,8 x 60
OD660-015



GLASS heather border NEW 2 x 60
OD640-005



GLASS heather border NEW 2 x 59,3
OD660-046



GLASS heather border NEW 2 x 50
OD660-062



GLASS heather border NEW 2 x 45
OD660-078



GLASS heather border NEW 1,5 x 40
OD660-094



GLASS violet border NEW 4,8 x 60
OD660-007



GLASS violet border NEW 2 x 60
OD660-023



GLASS violet border NEW 2 x 59,3
OD660-038



GLASS violet border NEW 2 x 50
OD660-054



GLASS violet border NEW 2 x 45
OD660-070



GLASS violet border NEW 1,5 x 40
OD660-086



GLASS cobalt border NEW 4,8 x 60
OD660-006



GLASS cobalt border NEW 2 x 60
OD660-022



GLASS cobalt border NEW 2 x 59,3
OD660-037









GLASS cobalt border NEW 2 x 50
OD660-053



GLASS cobalt border NEW 2 x 45
OD660-069



GLASS cobalt border NEW 1,5 x 40
OD660-085

 cm	 cm	 pcs	 cm	 cm	 pcs
20x20 inserto	0,8	1	2x60	1	21
14,8x14,8 mosaic	0,8	10	2x59,3	1	21
9,9x29,7 inserto	0,8	4	2x50	0,8	10
9,9x9,9 inserto	0,8	16	2x45	0,8	10
4,8x60	1	7	1,5x40	0,8	10

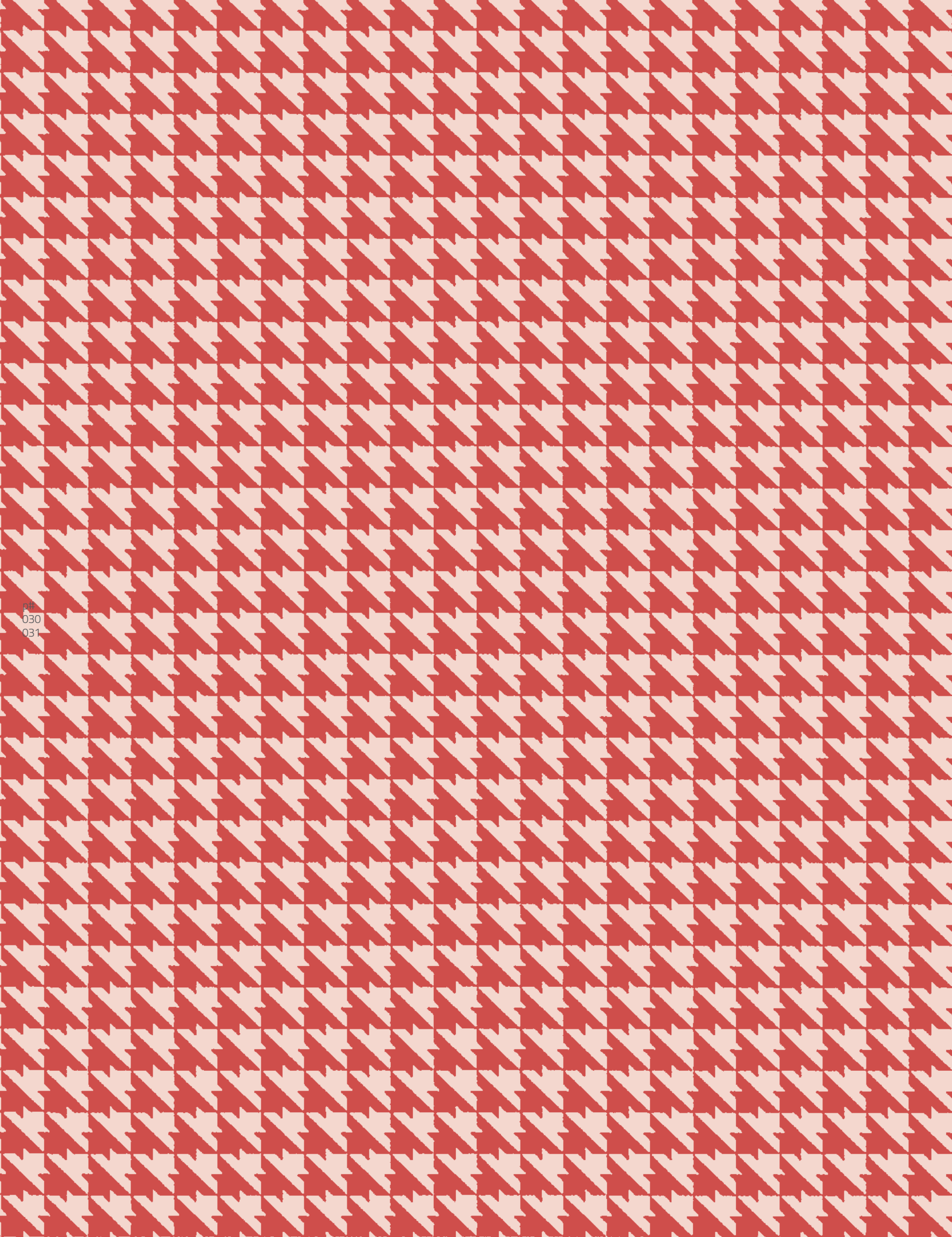

PH
030
031

Łazienka

Bathroom

modern



p#
032
033



new

Dusk
modern

45x90



DUSK grey
59,3 x 59,3
OP637-011-1



DUSK grey
44,4 x 89
OP637-009-1

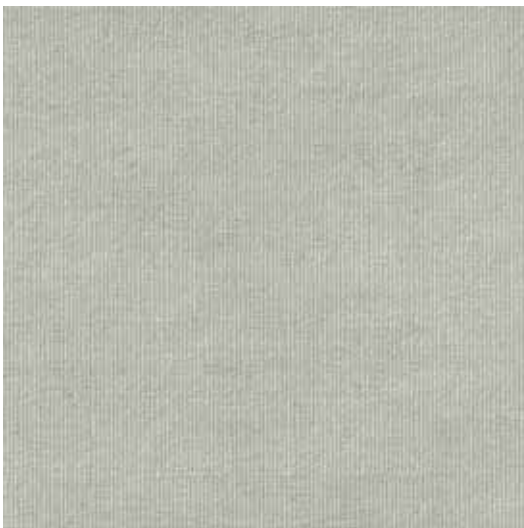

DUSK grey textile
59,3 x 59,3
OP637-015-1



DUSK grey textile
44,4 x 89
OP637-013-1



DUSK grey
29 x 59,3
OP637-019-1



DUSK grey mosaic
29 x 29,5
OD637-022



DUSK grey textile
29 x 59,3
OP637-020-1



p#
034
035

Dusk

45x90



DUSK beige
44,4 x 89
OP637-001-1



DUSK beige
59,3 x 59,3
OP637-003-1



DUSK beige textile
44,4 x 89
OP637-005-1



DUSK beige textile
59,3 x 59,3
OP637-007-1



DUSK beige
29 x 59,3
OP637-017-1



DUSK beige textile
29 x 59,3
OP637-018-1



DUSK beige mosaic
29 x 29,5
OD637-021



matt tiles



rectified tiles



structured tiles

cm	cm	pcs	m ²	kg	kg/m ²	m ²	cm	cm	pcs
44,4x89	1,2	3	1,18	28,97	24,55	21,24	29x29,5 mosaic	1	10
59,3x59,3	1,0	5	1,76	42,5	24,15	35,2			
29x59,3	1,0	7	1,2	28,0	23,33	38,4			

5

4

abrasion-resistance class

R11

R10

non-slip class



frost-resistant tile

p#
036
037



new

Equinox
modern

45x90



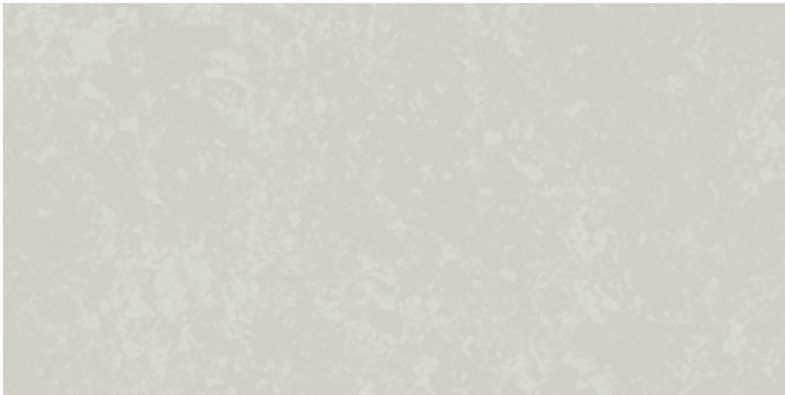

EQUINOX white
44,4 x 89
OP638-005-1



EQUINOX white
59,3 x 59,3
OP638-007-1



EQUINOX white
21,8 x 89
OP638-014-1

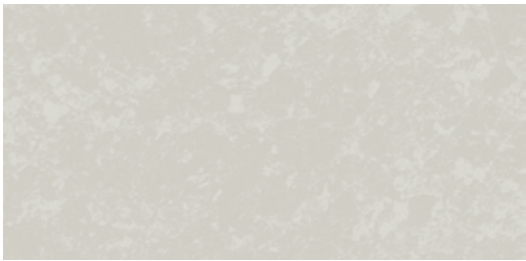

EQUINOX white
29 x 59,3
OP638-015-1

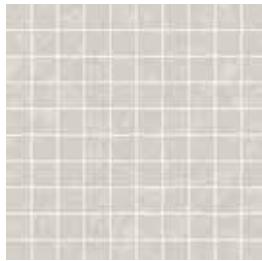

EQUINOX white mosaic square
29 x 29
OD638-011



EQUINOX mix mosaic belt
29 x 29,5
OD638-020



EQUINOX white border
2 x 59,3
OD638-016

p#
038
039

new

Equinox

45x90



EQUINOX black
59,3 x 59,3
OP638-003-1

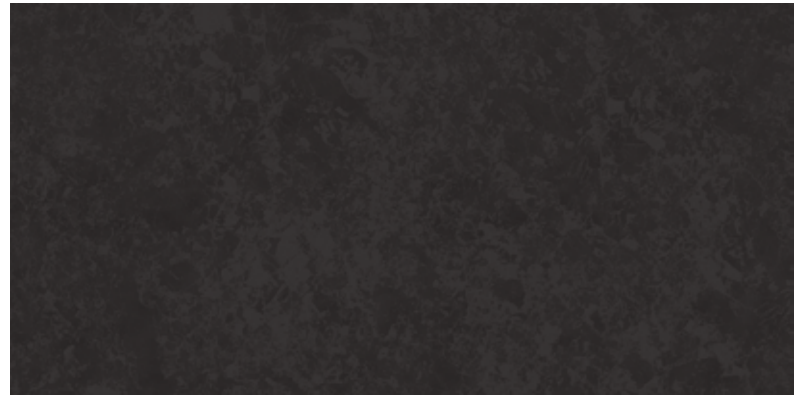

EQUINOX black
44,4 x 89
OP638-001-1



EQUINOX black
21,8 x 89
OP638-012-1

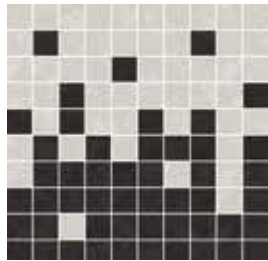

EQUINOX mix mosaic square
29 x 29
OD638-010

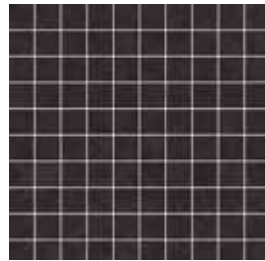

EQUINOX black mosaic square
29 x 29
OD638-009



EQUINOX black
29 x 59,3
OP638-013-1



EQUINOX black border
2 x 59,3
OD638-017



matt tiles



rectified tiles

cm	cm	pcs	m ²	kg	kg/m ²	m ²	cm	cm	pcs
44,4x89	1,2	3	1,18	28,97	24,55	21,24	29x29,5 mosaic	1	12
21,8x89	1,2	5	0,97	23,81	24,55	23,28	2x59,3	1	32
59,3x59,3	1,0	5	1,76	42,5	24,15	35,2			
29x59,3	1,0	7	1,2	28,0	23,33	38,4			



abrasion-resistance class



non-slip class



frost-resistant tile



p#
040
041

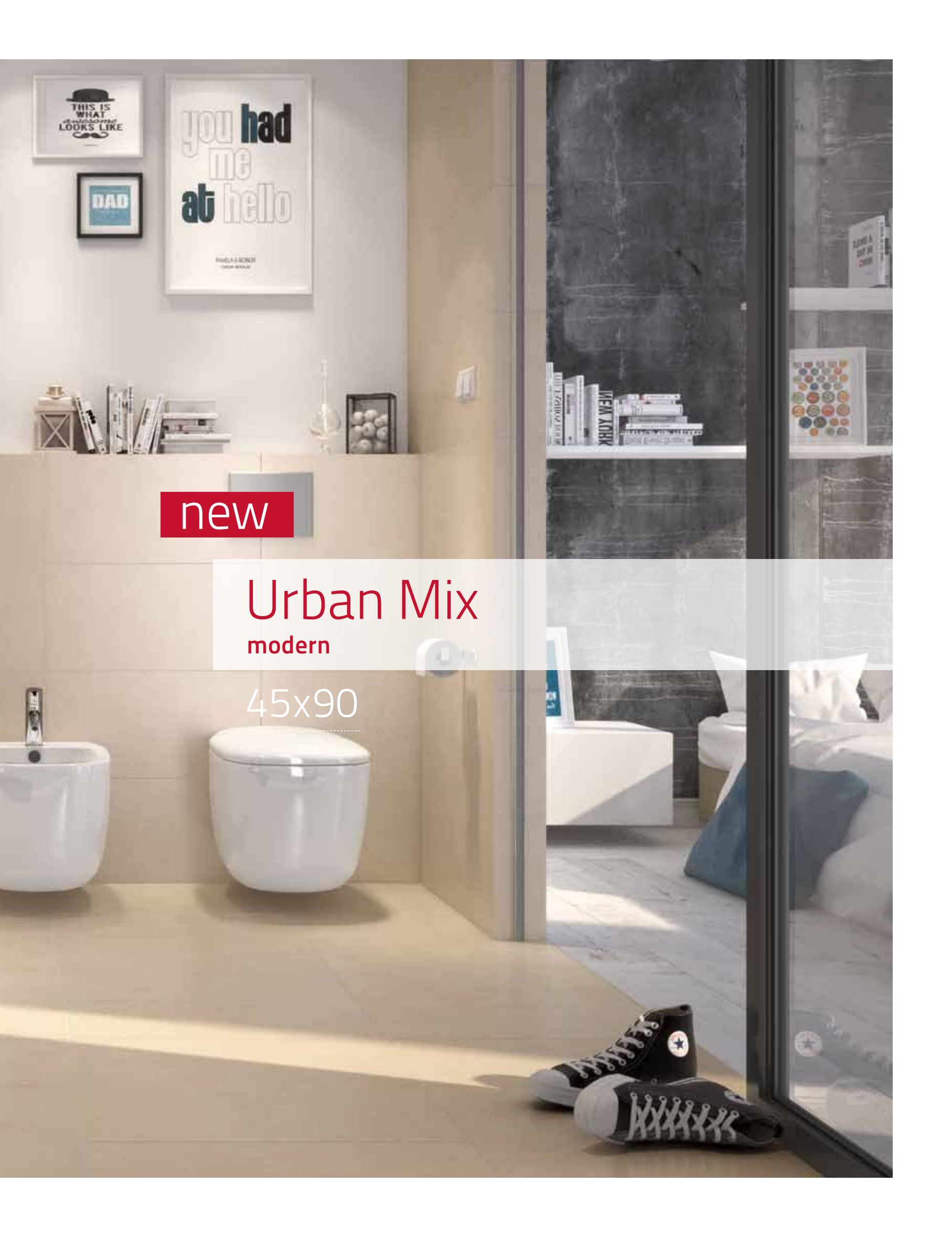

new

Urban Mix

modern

45x90



p#
042
043

new

Urban Mix

45x90



URBAN MIX cream
44,4 x 89
OP639-009-1



URBAN MIX cream
29,55 x 59,4
OP639-039-1



URBAN MIX cream
21,8 x 89
OP639-038-1



URBAN MIX cream
59,4 x 59,4
OP639-011-1

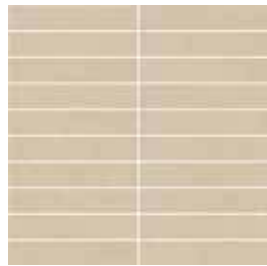

URBAN MIX cream mosaic
29,55 x 29,55
OD639-024

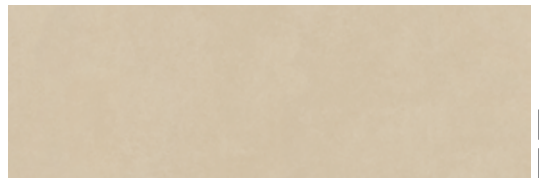

URBAN MIX cream
19 x 59,4
OP639-046-1





URBAN MIX beige
44,4 x 89
OP639-001-1



URBAN MIX beige
29,55 x 59,4
OP639-037-1



URBAN MIX beige
21,8 x 89
OP639-036-1



URBAN MIX beige
59,4 x 59,4
OP639-003-1

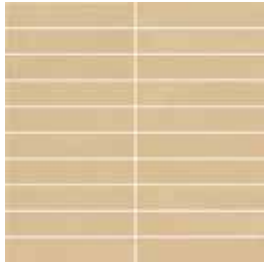

URBAN MIX beige mosaic
29,55 x 29,55
OD639-021



URBAN MIX beige
19 x 59,4
OP639-047-1

p#
044
045

new

Urban Mix

45x90



URBAN MIX light grey
44,4 x 89
OP639-017-1



URBAN MIX light grey
29,55 x 59,4
OP639-045-1



URBAN MIX light grey
21,8 x 89
OP639-044-1



URBAN MIX light grey
59,4 x 59,4
OP639-019-1

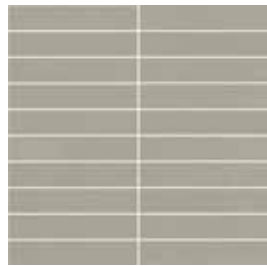

URBAN MIX light grey mosaic
29,55 x 29,55
OD639-033

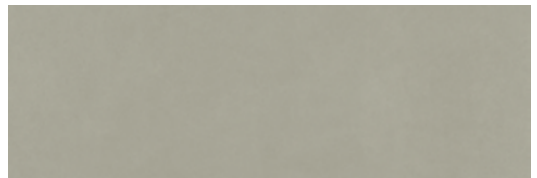

URBAN MIX light grey
19 x 59,4
OP639-048-1





URBAN MIX grey
44,4 x 89
OP639-013-1



URBAN MIX grey
29,55 x 59,4
OP639-043-1



URBAN MIX grey
21,8 x 89
OP639-042-1



URBAN MIX grey
59,4 x 59,4
OP639-015-1

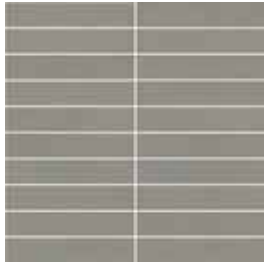

URBAN MIX grey mosaic
29,55 x 29,55
OD639-030

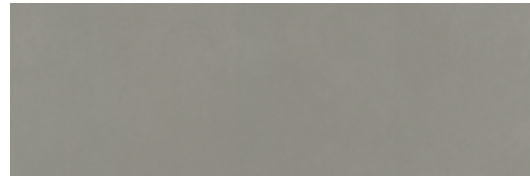

URBAN MIX grey
19 x 59,4
OP639-049-1

p#
046
047

new

Urban Mix

45x90



URBAN MIX graphite
44,4 x 89
OP639-005-1



URBAN MIX graphite
29,55 x 59,4
OP639-041-1



URBAN MIX graphite
21,8 x 89
OP639-040-1



URBAN MIX graphite
59,4 x 59,4
OP639-007-1

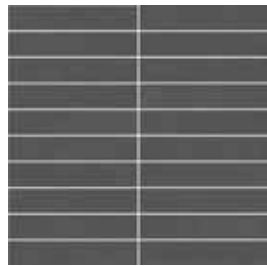

URBAN MIX graphite mosaic
29,55 x 29,55
OD639-027



URBAN MIX graphite
19 x 59,4
OP639-050-1



matt tiles rectified tiles

cm	cm	pcs	m ²	kg	kg/m ²	m ²	cm	cm	pcs
44,4x89	1,1	3	1,18	28,97	24,55	21,24			
21,8x89	1,1	5	0,97	23,81	24,55	23,28			
59,4x59,4	1,0	5	1,76	41,25	23,44	35,2			
29,55x59,4	1,0	8	1,4	33,0	23,57	44,8			
19x59,4	1,0	8	0,9	21,21	23,57	43,2			
29,55x29,55 mosaic	1,0	12	-	-	-	-			

non-slip class

frost-resistant tile

p#
048
049





new

Kando

modern

60x60



KANDO off-white satin 59,4 x 59,4
W164-268-1
KANDO off-white polished 59,4 x 59,4
W164-269-1

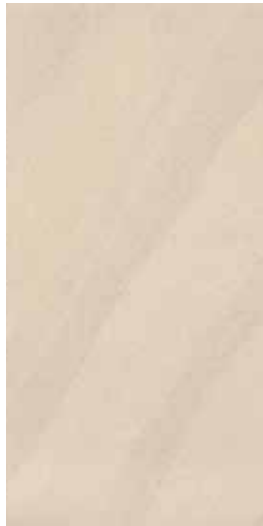

KANDO off-white satin 29,55 x 59,4
W164-270-1
KANDO off-white polished 29,55 x 59,4
W164-271-1



KANDO off-white mosaic strips satin
14,7 x 41
WD164-274



KANDO grey satin 59,4 x 59,4
W164-172-1
KANDO grey polished 59,4 x 59,4
W164-092-1



KANDO grey satin 29,55 x 59,4
W164-165-1
KANDO grey polished 29,55 x 59,4
W164-106-1



KANDO grey mosaic strips satin
14,7 x 41
WD164-067



GLASS white border NEW
2 x 59,3
OD660-040



GLASS beige border NEW
2 x 59,3
OD660-042



GLASS silver border NEW
2 x 59,3
OD660-044



GLASS dark beige border NEW
2 x 59,3
OD660-039



GLASS black border NEW
2 x 59,3
OD660-041



GLASS red border NEW
2 x 59,3
OD660-047

Kando

60x60

p#
050
051

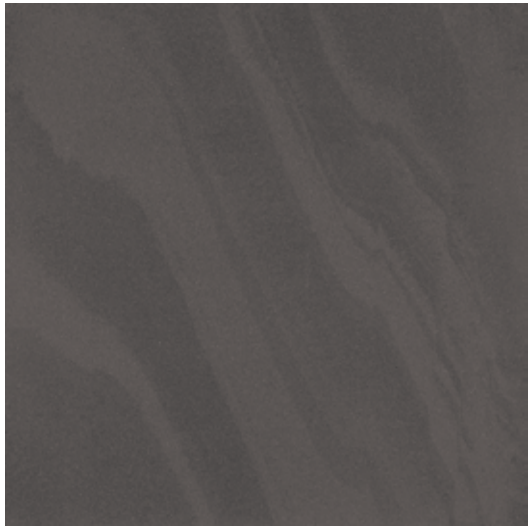

KANDO graphite satin 29,55 x 59,4
W164-247-1
KANDO graphite polished 29,55 x 59,4
W164-251-1

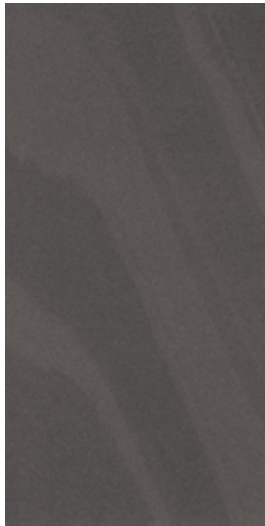

KANDO graphite satin 29,55 x 59,4
W164-248-1
KANDO graphite polished 29,55 x 59,4
W164-253-1

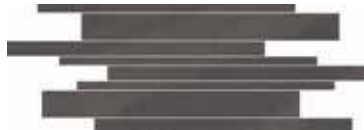

KANDO graphite mosaic strips satin
14,7 x 41
WD164-261



KANDO anthracite satin 59,4 x 59,4
W164-244-1
KANDO anthracite polished 59,4 x 59,4
W164-250-1



KANDO anthracite satin 29,55 x 59,4
W164-245-1
KANDO anthracite polished 59,4 x 59,4
W164-252-1



KANDO anthracite mosaic strips satin
14,7 x 41
WD164-260



rectified tiles

cm	cm	pcs	m²	kg	kg/m²	m²	cm	cm	pcs
29,55x59,4 satin	1	8	1,4	33	23,57	44,8	14,7 x 41	1	8
29,55x59,4 polished	1	8	1,4	31,29	22,35	44,8	2 x 59,3 glass	1	21
59,4x59,4 satin	1	5	1,76	41,25	23,44	35,2			
59,4x59,4 polished	1	5	1,76	39,74	22,58	35,2			

* R10 - only matt tiles





p#
052
053



Allwood
modern

30x60



p#
054
055

Allwood
30x60

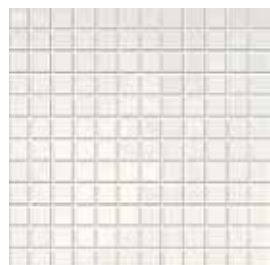

PALETTE white glossy mosaic
30 x 30
OP041-002-1



ALLWOOD pine
14,8 x 59,8
OP361-001-1



4



ALLWOOD pine
29,7 x 59,8
OP361-005-1



4

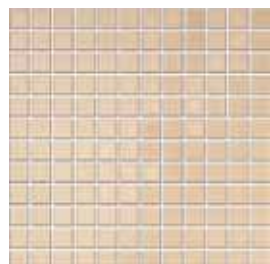

PALETTE beige glossy mosaic
30 x 30
OP041-001-1



ALLWOOD oak
14,8 x 59,8
OP361-002-1



4



ALLWOOD oak
29,7 x 59,8
OP361-006-1



4



PALETTE brown-gold glossy mosaic
30 x 30
OP041-004-1



ALLWOOD teak
14,8 x 59,8
OP361-003-1



3



ALLWOOD teak
29,7 x 59,8
OP361-007-1



3



ALLWOOD nut
14,8 x 59,8
OP361-004-1



3



ALLWOOD nut
29,7 x 59,8
OP361-008-1



3



GLASS white border NEW
4,8 x 60
OD660-009



GLASS beige border NEW
4,8 x 60
OD660-011



GLASS brown border NEW
4,8 x 60
OD660-012



matt
tiles

cm	cm	pcs	m ²	kg	kg/m ²	m ²	cm	cm	pcs
14,8 x 59,8	0,85	10	0,88	18,20	20,57	31,68	4,8X60 glass	1	7
29,7x 59,8	0,85	9	1,60	31,01	19,38	51,20			
30x30	0,60	12	1,08	12,1	11,2	38,88			

4 3

abrasion-resistance class



frost-resistant tile

p#
056
057





Amarante
modern

30x60



p#
058
059

Amarante

30x60

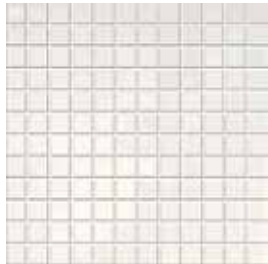

PALETTE white glossy mosaic
30 x 30
OP041-002-1



AMARANTE cream
29,7 x 59,8
OP009-005-1



AMARANTE cream structure
29,7 x 59,8
OP009-006-1

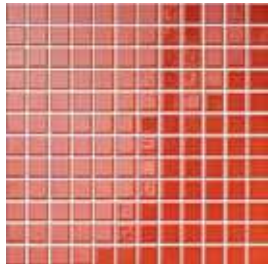

PALETTE red glossy mosaic
30 x 30
OP041-006-1



AMARANTE brown
29,7 x 59,8
OP009-001-1



AMARANTE graphite
29,7 x 59,8
OP009-003-1

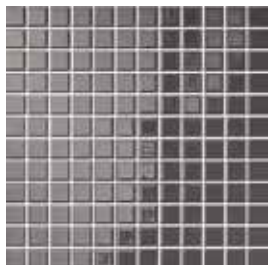

PALETTE grey glossy mosaic
30 x 30
OP041-010-1



AMARANTE brown structure
29,7 x 59,8
OP009-002-1



AMARANTE graphite structure
29,7 x 59,8
OP009-004-1

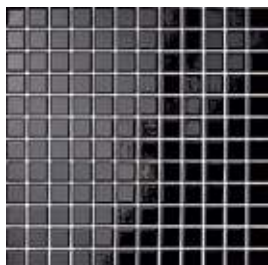

PALETTE black glossy mosaic
30 x 30
OP041-005-1



AMARANTE brown inserto modern
29,7 x 59,8
OD009-007



AMARANTE graphite inserto modern
29,7 x 59,8
OD009-008

METALIC silver border
1,5 x 59,8
OD011-013

GLASS orange border
2 x 59,8
OD009-011

GLASS red border
2 x 59,8
OD009-012



matt tiles



structured tiles

cm	cm	pcs	m ²	kg	kg/m ²	m ²	cm	cm	pcs
29,7x59,8	0,85	9	1,6	30,5	19,06	51,2	2x59,8	1	21
29,7x59,8 inserto	0,85	9	-	-	-	-	1,5x59,8	1	32
30x30	0,60	12	1,08	12,1	11,2	38,88			



abrasion-resistance class



frost-resistant tile

p#
060
061



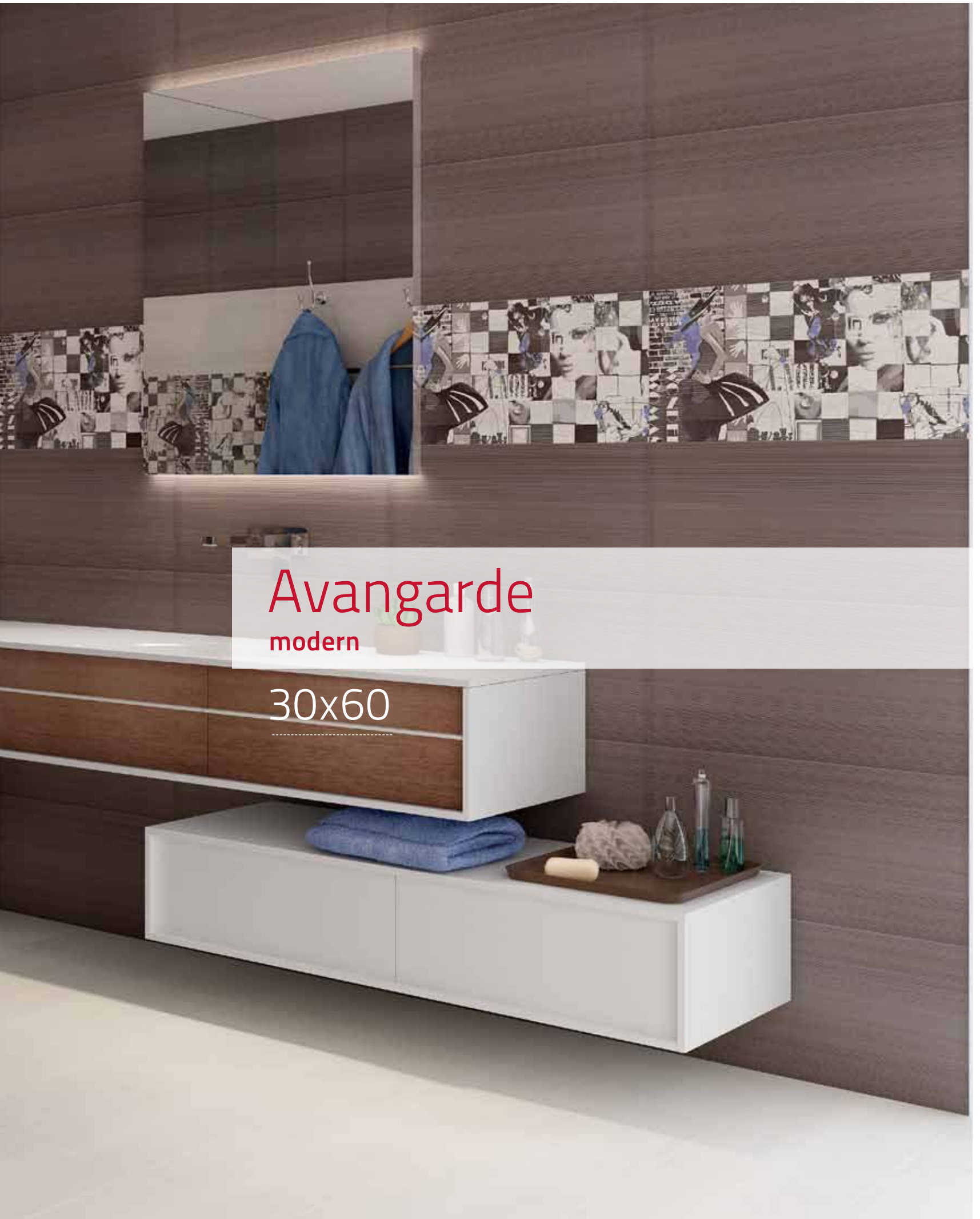

Avangarde
modern

30x60



p#
062
063

Avangarde
30x60

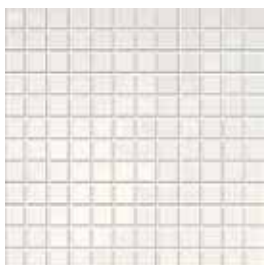

PALETTE white glossy mosaic
30 x 30
OP041-002-1



AVANGARDE inserto flower
29,7 x 60
OD352-001



AVANGARDE white
29,7 x 60
OP352-003-1

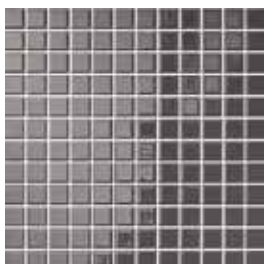

PALETTE grey glossy mosaic
30 x 30
OP041-010-1



AVANGARDE inserto modern
29,7 x 60
OD352-002



AVANGARDE grey
29,7 x 60
OP352-006-1

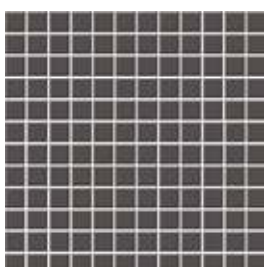

3

PALETTE grey mat mosaic
30 x 30
OP041-020-1



GLASS red border
2 x 60
OD352-007

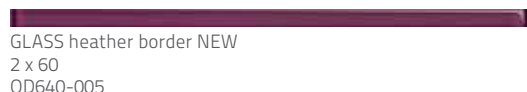

GLASS heather border NEW
2 x 60
OD640-005



GLASS azure border NEW
2 x 60
OD660-021



GLASS violet border NEW
2 x 60
OD660-023

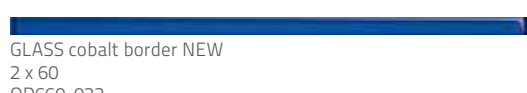

GLASS cobalt border NEW
2 x 60
OD660-022



AVANGARDE graphite
29,7 x 60
OP352-005-1



4

AVANGARDE white
33,3 x 33,3
OP352-008-1



glossy tiles

cm	cm	pcs	m ²	kg	kg/m ²	m ²	cm	cm	pcs
29,7x60	0,9	7	1,25	22,51	18,01	40	2x60 glass	1	21
29,7x60 inserto	0,9	7	-	-	-	-			
33,3x33,3	0,8	12	1,33	20,97	15,77	63,84			

4

abrasion-resistance class



frost-resistant tile



p#
064
065



new

Basic Palette

modern

30x60

p#
066
067

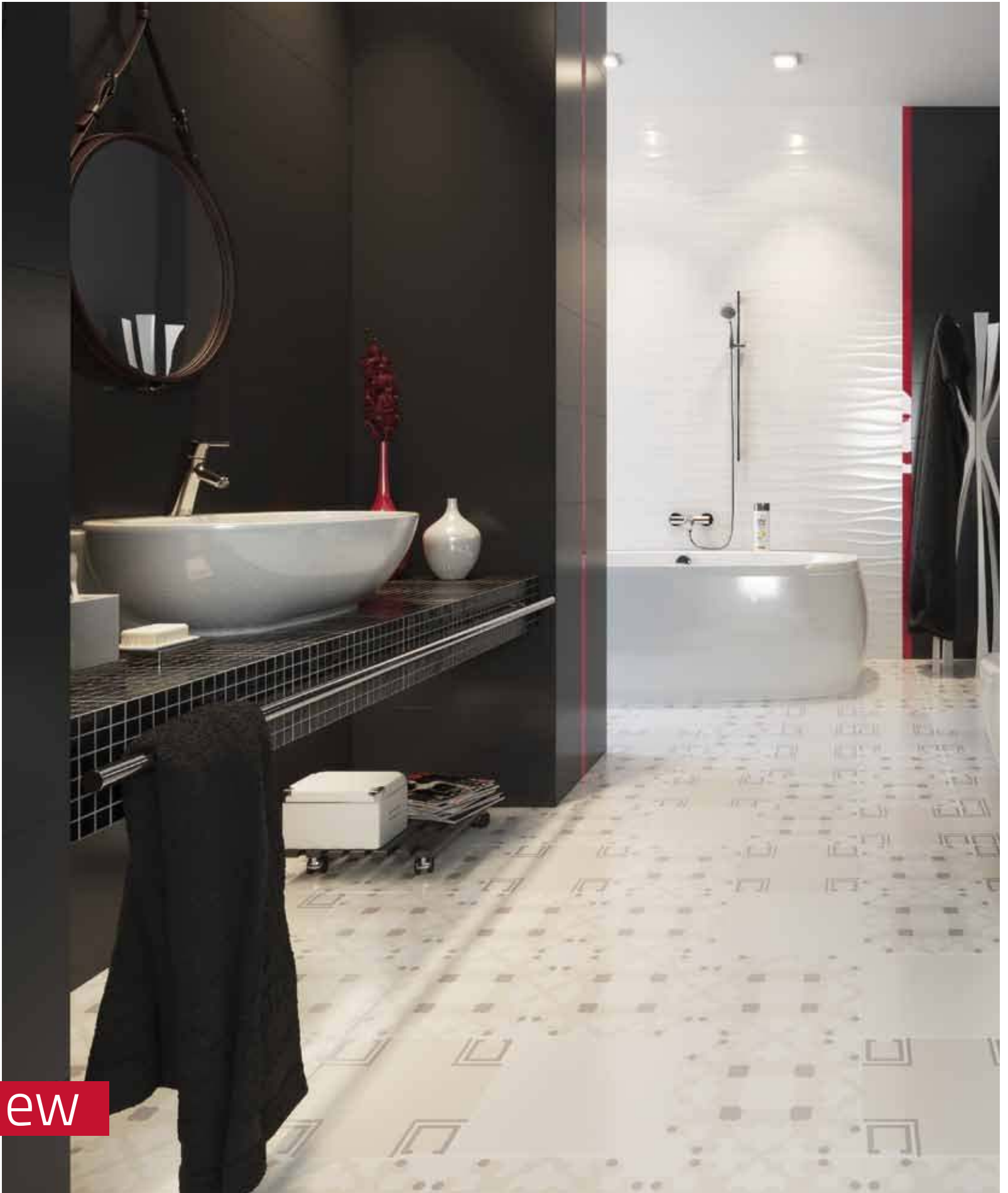

new

Basic Palette

30x60



BEIGE GLOSSY
29,7 x 60
OP631-035-1

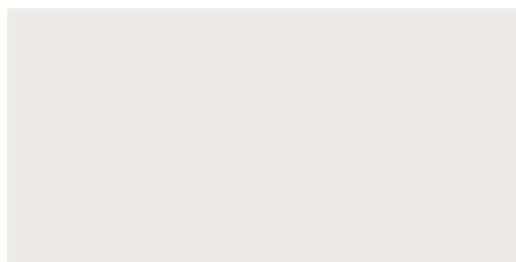

WHITE GLOSSY
29,7 x 60
OP631-032-1

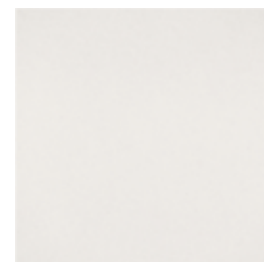

WHITE SEMI-GLOSSY
29,7 x 29,7
OP631-037-1



BEIGE GLOSSY WAVE
29,7 x 60
OP631-034-1



WHITE GLOSSY WAVE
29,7 x 60
OP631-031-1



WHITE PATTERN B
29,7 x 29,7
OP631-039-1



VIOLET SATIN
29,7 x 60
OP631-036-1



GRAPHITE SATIN
29,7 x 60
OP631-033-1



WHITE PATTERN C
29,7 x 29,7
OP631-040-1



GLASS beige border
4,8 x 60
OD631-021



GLASS blue border
4,8 x 60
OD631-024



GLASS black border
4,8 x 60
OD631-046



GLASS red border
4,8 x 60
OD631-025

p#
068
069





new

Basic Palette

modern

30x60

p#
070
071



new

Basic Palette

30x60



BEIGE SATIN
29,7 x 60
OP631-029-1

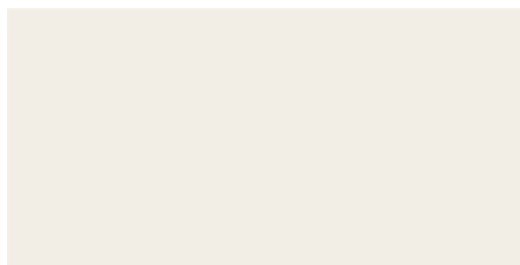

WHITE SATIN
29,7 x 60
OP631-047-1

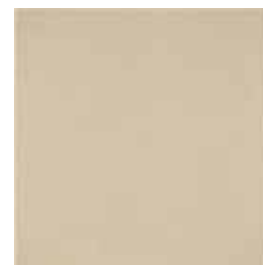

BEIGE SEMI-GLOSSY
29,7 x 29,7
OP631-041-1



BEIGE SATIN BRAID
29,7 x 60
OP631-028-1



WHITE SATIN BRAID
29,7 x 60
OP631-026-1



BEIGE PATTERN B
29,7 x 29,7
OP631-043-1



MOCCA SATIN
29,7 x 60
OP631-030-1



GREY SATIN
29,7 x 60
OP631-027-1



BEIGE PATTERN C
29,7 x 29,7
OP631-044-1



GLASS mocca border
4,8 x 60
OD631-022



GLASS pearl border
4,8 x 60
OD631-020



GLASS yellow border
4,8 x 60
OD631-045



GLASS turquoise border
4,8 x 60
OD631-023



matt tiles



glossy tiles



structured tiles

cm	cm	pcs	m ²	kg	kg/m ²	m ²	cm	cm	pcs
29,7x60	0,9	7	1,25	22,51	18,01	40,0	4,8 x 60 glass	1	7
29,7x29,7	0,8	15	1,32	22,66	17,17	58,08			

4 abrasion-resistance class

R10 non-slip class

☄ frost-resistant tile



p#
072
073



new

Creamy Touch

modern

30x60



p#
074
075

new

Creamy Touch

30x60

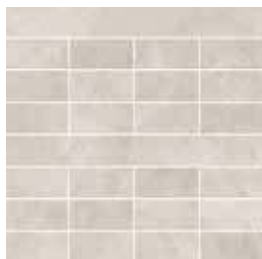

CREAMY TOUCH mosaic
29 x 29,5
OD635-011



CREAMY TOUCH structure
29 x 59,3
OP635-010-1



CREAMY TOUCH
29 x 59,3
OP635-008-1



CREAMY TOUCH belt
29 x 59,3
OD635-012



CREAMY TOUCH pattern
29 x 59,3
OP635-009-1



CREAMY TOUCH composition flower
58,3 x 59,3
OD635-014



CREAMY TOUCH
59,3 x 59,3
OP635-006-1



GLASS white border NEW
2 x 59,3
OD660-040



GLASS heather border NEW
2 x 59,3
OD660-046



GLASS beige border NEW
2 x 59,3
OD660-042



GLASS violet border NEW
2 x 59,3
OD660-038



matt tiles



structured tiles



rectified tiles

cm	cm	pcs	m ²	kg	kg/m ²	m ²	cm	cm	pcs
59,3x59,3	1	5	1,76	42,5	24,15	35,2	2x59,3 glass	1	21
29x59,3	1,1	7	1,2	22,8	19,0	38,4			
29x59,3 structure	1,1	7	1,2	22,8	19,0	38,4			
29x59,3 mosaic	1	6	-	-	-	-			
29x29 mosaic	1	12	-	-	-	-			



abrasion-resistance class



non-slip class



frost-resistant tile



p#
076
077



Damasco

modern

30x60

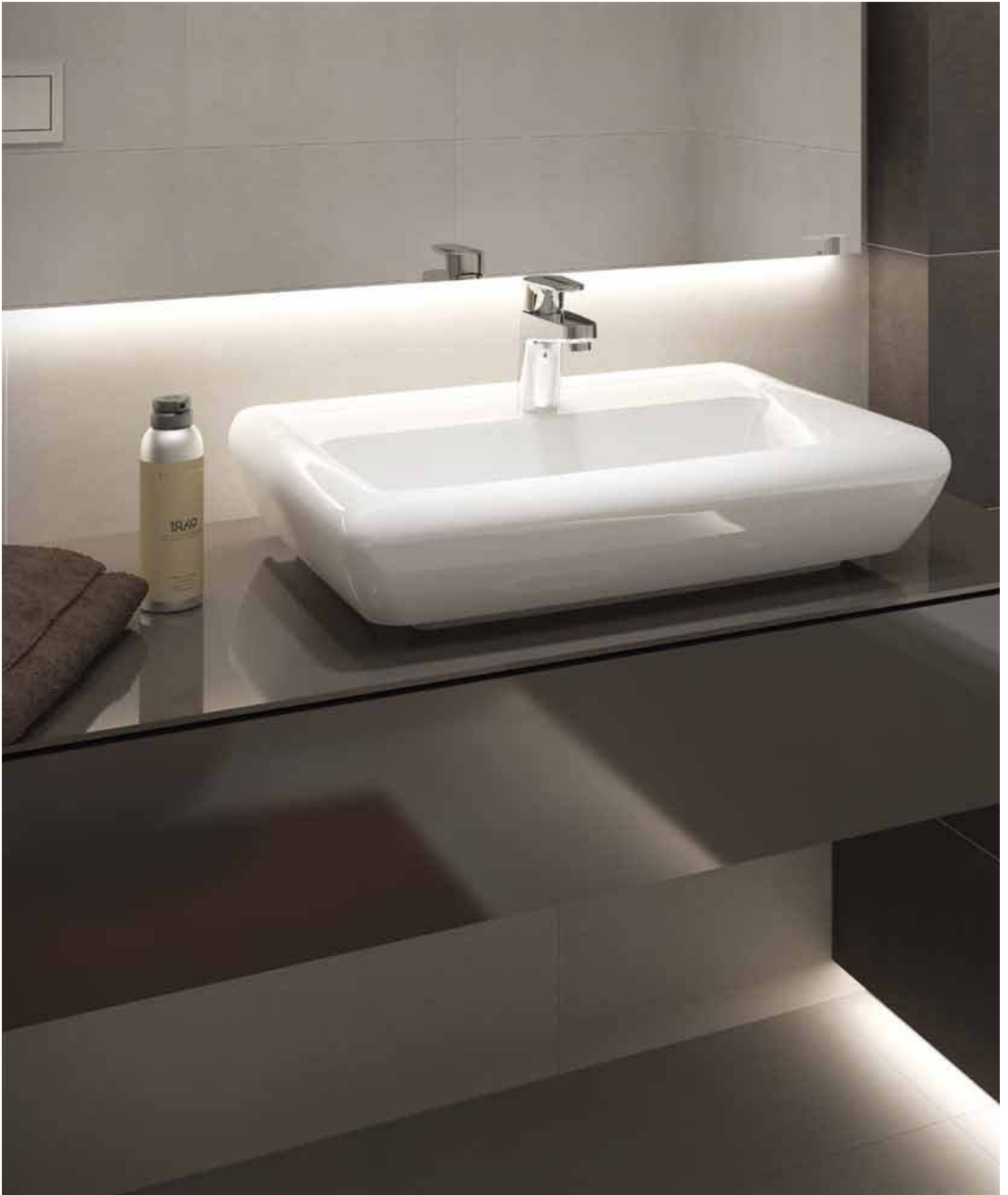

p#
078
079

Damasco
30x60



DAMASCO vanilla
29,7 x 29,7
OP067-005-1



DAMASCO vanilla
29,7 x 59,8
OP067-018-1



GLASS white border
2 x 59,8
OD067-026

GLASS brown border
2 x 59,8
OD067-025

GLASS black border
2 x 59,8
OD067-024



DAMASCO anthracite
29,7 x 29,7
OP067-001-1



DAMASCO anthracite
29,7 x 59,8
OP067-022-1



new



DAMASCO anthracite
59,8 x 59,8
OP067-030-1



DAMASCO mocca
29,7 x 29,7
OP067-004-1



DAMASCO mocca
29,7 x 59,8
OP067-020-1



new



DAMASCO mix border
7,3 x 34,7
OD067-027



DAMASCO vanilla
59,8 x 59,8
OP067-028-1



new



DAMASCO mocca
59,8 x 59,8
OP067-029-1



cm	cm	pcs	m ²	kg	kg/m ²	m ²	cm	cm	pcs
59,8x59,8	1,0	5	1,79	24,15	43,23	35,80	2x59,8	1	21
29,7x59,8	0,85	9	1,6	31,33	19,58	51,20	7,3x34,7	0,85	5
29,7x29,7	0,80	15	1,32	22,66	17,17	58,08			



abrasion-resistance class



non-slip class



frost-resistant tile

p#
080
081



new

Early Pastels

modern

30x60





EARLY PASTELS beige
29 x 59,3
OP647-007-1



EARLY PASTELS beige
inserto flower 29 x 59,3
OP647-019



EARLY PASTELS grey
29 x 59,3
OP647-008-1



EARLY PASTELS grey
inserto flower 29 x 59,3
OP647-020



EARLY PASTELS beige mosaic
29 x 29,5
OD647-015

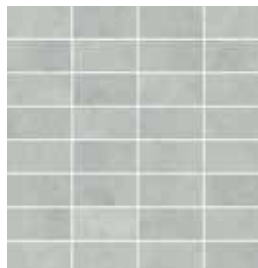

EARLY PASTELS grey mosaic
29 x 29,5
OD647-016



GLASS dark beige border NEW
2 x 59,3
OD660-039



GLASS white border NEW
2 x 59,3
OD660-040



GLASS brown border NEW
2 x 59,3
OD660-043



GLASS silver border NEW
2 x 59,3
OD660-044

p#
082
083

new

Early Pastels

30x60



❄️
R10
5

EARLY PASTELS beige
59,3 x 59,3
OP647-009-1



❄️
R10
5

EARLY PASTELS grey
59,3 x 59,3
OP647-011-1



❄️
R10
4











EARLY PASTELS beige strips
59,3 x 59,3
OP647-010-1



❄️
R10
4

EARLY PASTELS grey strips
59,3 x 59,3
OP647-012-1

 matt tiles  rectified tiles

 cm	 cm	 pcs	 m ²	 kg	 kg/m ²	 m ²	 cm	 cm	 pcs
59,3x59,3	1	5	1,76	42,50	24,15	35,20	2x59,3	1	21
29x59,3	1	7	1,2	28,0	23,33	38,40			
29x59,3 inserto	1	7	-	-	-	-			
29x29,5 mosaic	1	11	-	-	-	-			

p#
084
085





Fargo

modern

30x60

new



FARGO white
59,8 x 59,8
OP360-013-1



new



FARGO grey
59,8 x 59,8
OP360-014-1



p#
086
087



FARGO white
29,7 x 59,8
OP360-008-1



FARGO grey
29,7 x 59,8
OP360-007-1

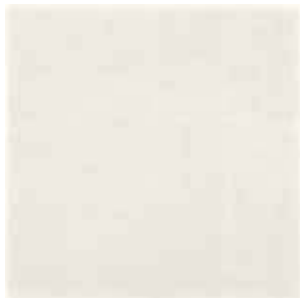

FARGO white
32,6 x 32,6
OP360-012-1



FARGO white mosaic
29,7 x 29,7
OD360-004



FARGO grey
32,6 x 32,6
OP360-011-1



FARGO grey mosaic
29,7 x 29,7
OD360-003



GLASS azure border NEW
2 x 60
OD660-021

GLASS turquoise border NEW
2 x 60
OD660-020

GLASS violet border NEW
2 x 60
OD660-023

GLASS orange border NEW
2 x 60
OD660-017

GLASS black border NEW
2 x 60
OD660-026

GLASS cobalt border NEW
2 x 60
OD660-022

Fargo
30x60

new



FARGO brown
59,8 x 59,8
OP360-015-1



new



FARGO black
59,8 x 59,8
OP360-016-1



FARGO brown
29,7 x 59,8
OP360-006-1

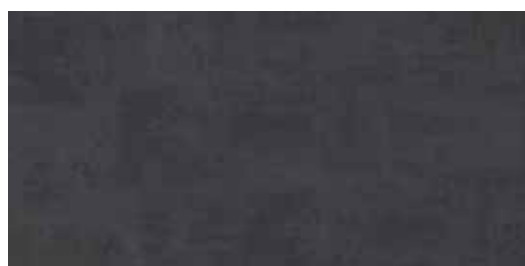

FARGO black
29,7 x 59,8
OP360-005-1



FARGO brown
32,6 x 32,6
OP360-010-1

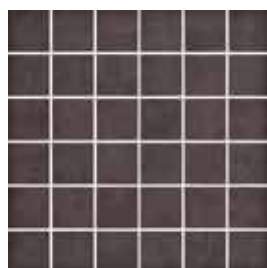

FARGO brown mosaic
29,7 x 29,7
OD360-002



FARGO black
32,6 x 32,6
OP360-009-1



FARGO black mosaic
29,7 x 29,7
OD360-001



matt tiles

cm	cm	pcs	m ²	kg	kg/m ²	m ²	cm	cm	pcs
59,8x59,8	1,0	5	1,79	43,23	24,15	35,8	2x60 glass	1	21
29,7x59,8	0,85	9	1,6	28,75	17,97	51,2			
29,7x29,7 mosaic	0,8	14	-	-	-	-			
32,6x32,6	0,8	12	1,17	21,11	18,04	56,16			

abrasion-resistance class

non-slip class

frost-resistant tile

p#
088
089





French Touch

modern

30x60



p#
090
091

French Touch

30x60



FRENCH TOUCH butterfly inserto
58,3 x 59,3
OP630-002



FRENCH TOUCH pierrot inserto
58,3 x 59,3
OP630-003

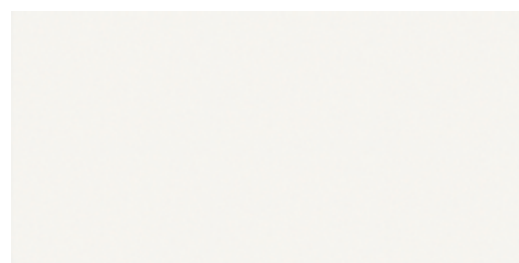

WHITE SATIN
29 x 59,3
OP630-001-1



GLASS white border NEW
2 x 59,3
OD660-040



GLASS red border NEW
2 x 59,3
OD660-047



GLASS silver border NEW
2 x 59,3
OD660-044



GLASS brown border NEW
2 x 59,3
OD660-043



matt
tiles



rectified
tiles

cm	cm	pcs	m ²	kg	kg/m ²	m ²	cm	cm	pcs
29x59,3	0,9	7	1,2	22,8	19,0	38,4	2x59,3 glass	1	21
58,3x59,3 inserto	0,9	2 sets	-	-	-	-			

p#
092
093



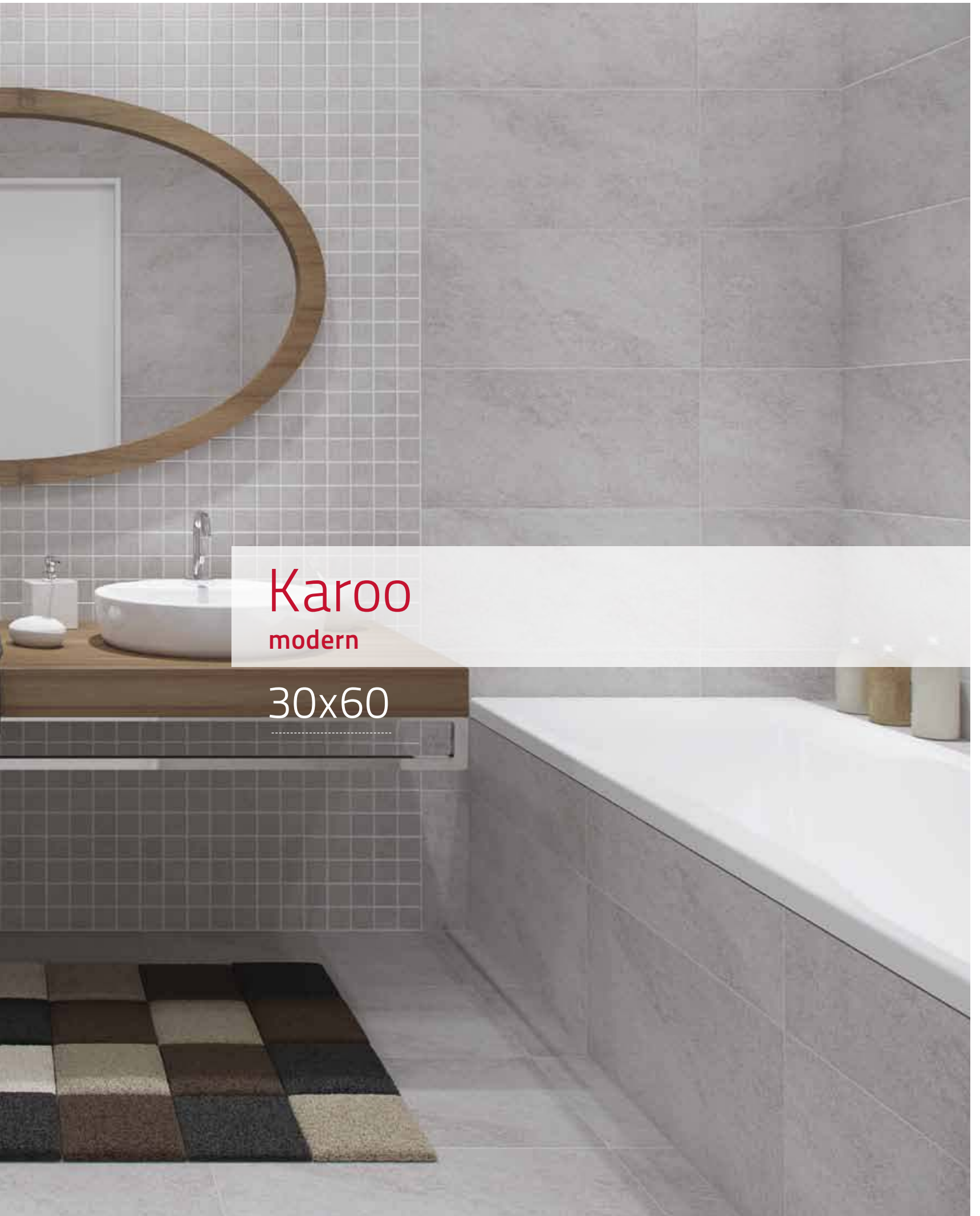

Karoo
modern

30x60

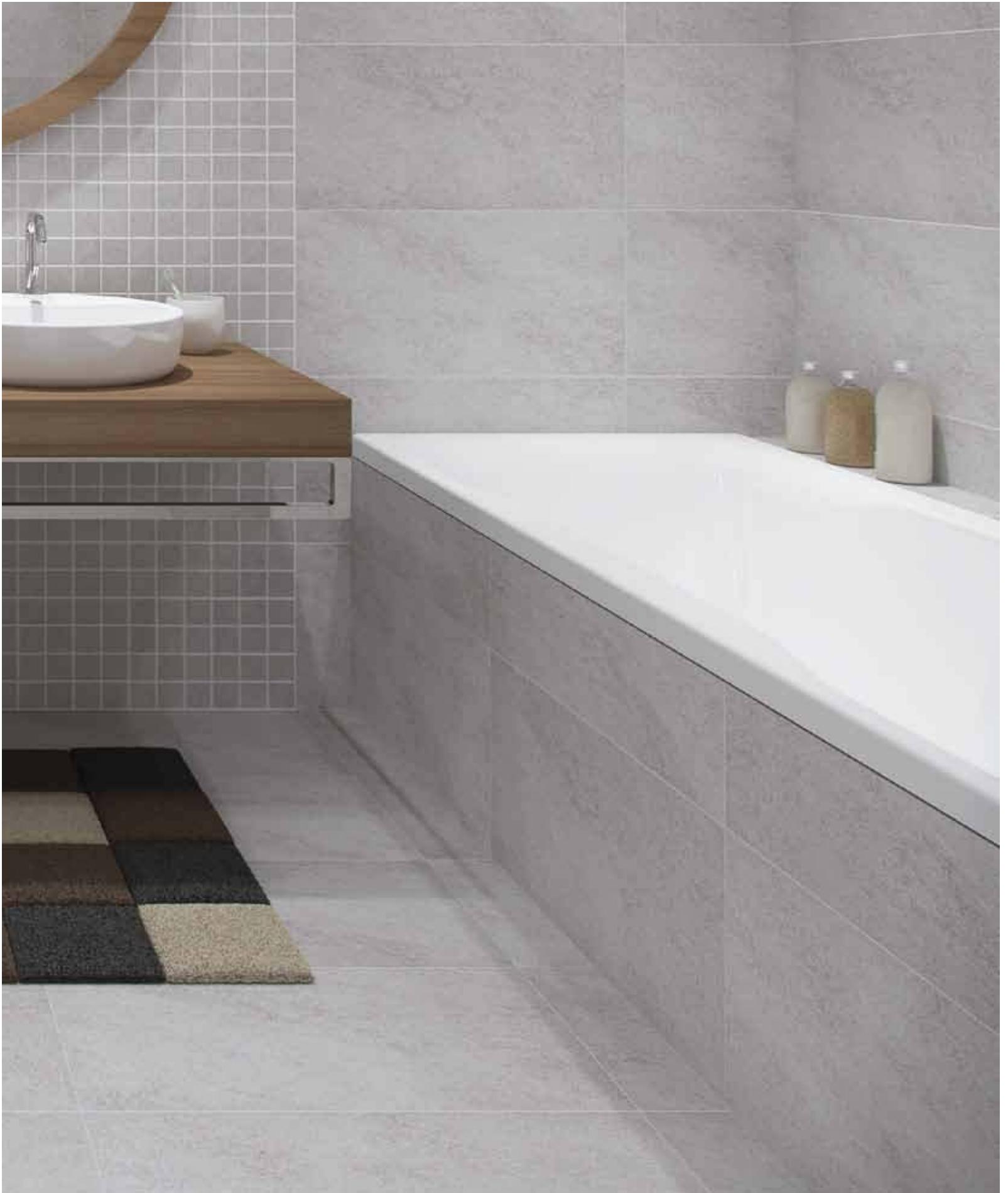

p#
094
095

Karoo
30x60



KAROO cream glass mosaic
14,7 x 29,7
OD193-004

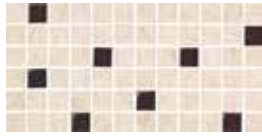

KAROO beige glass mosaic
14,7 x 29,7
OD193-005

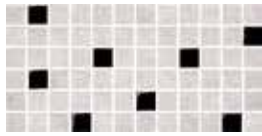

KAROO grey glass mosaic
14,7 x 29,7
OD193-006

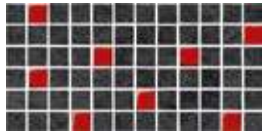

KAROO graphite glass mosaic
14,7 x 29,7
OD193-011

new



KAROO cream
29,7 x 59,8
OP193-002-1



KAROO grey
29,7 x 59,8
OP193-003-1



KAROO beige
29,7 x 59,8
OP193-001-1



KAROO graphite
29,7 x 59,8
OP193-010-1



new



GLASS red border NEW
4,8 x 60
OD660-016



GLASS white border NEW
4,8 x 60
OD660-009



GLASS red border NEW
2 x 60
OD660-031



GLASS white border NEW
2 x 60
OD660-025



GLASS brown border NEW
4,8 x 60
OD660-012



GLASS black border NEW
4,8 x 60
OD660-010



GLASS brown border NEW
2 x 60
OD660-028



GLASS black border NEW
2 x 60
OD660-026



KAROO cream mosaic
29,7 x 29,7
OD193-007



KAROO beige mosaic
29,7 x 29,7
OD193-008

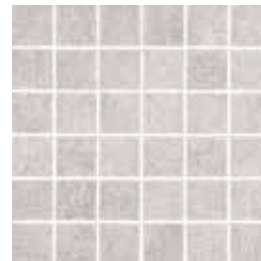

KAROO grey mosaic
29,7 x 29,7
OD193-009

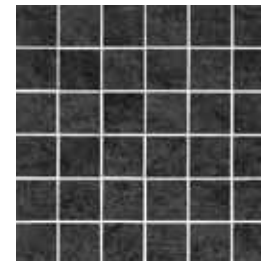

KAROO graphite mosaic
29,7 x 29,7
OD193-012



new



matt tiles



structured tiles

cm	cm	pcs	m ²	kg	kg/m ²	m ²	cm	cm	pcs
29,7x59,8	0,85	9	1,6	30,50	19,06	51,20	2x60 glass	1	21
29,7x29,7 mosaic	0,85	15	-	-	-	-	4,8x60 glass	1	7
14,7x29,7 mosaic	0,85	28	-	-	-	-			



abrasion-resistance class



non-slip class



frost-resistant tile

p#
096
097



new

Light Marble

modern

30x60

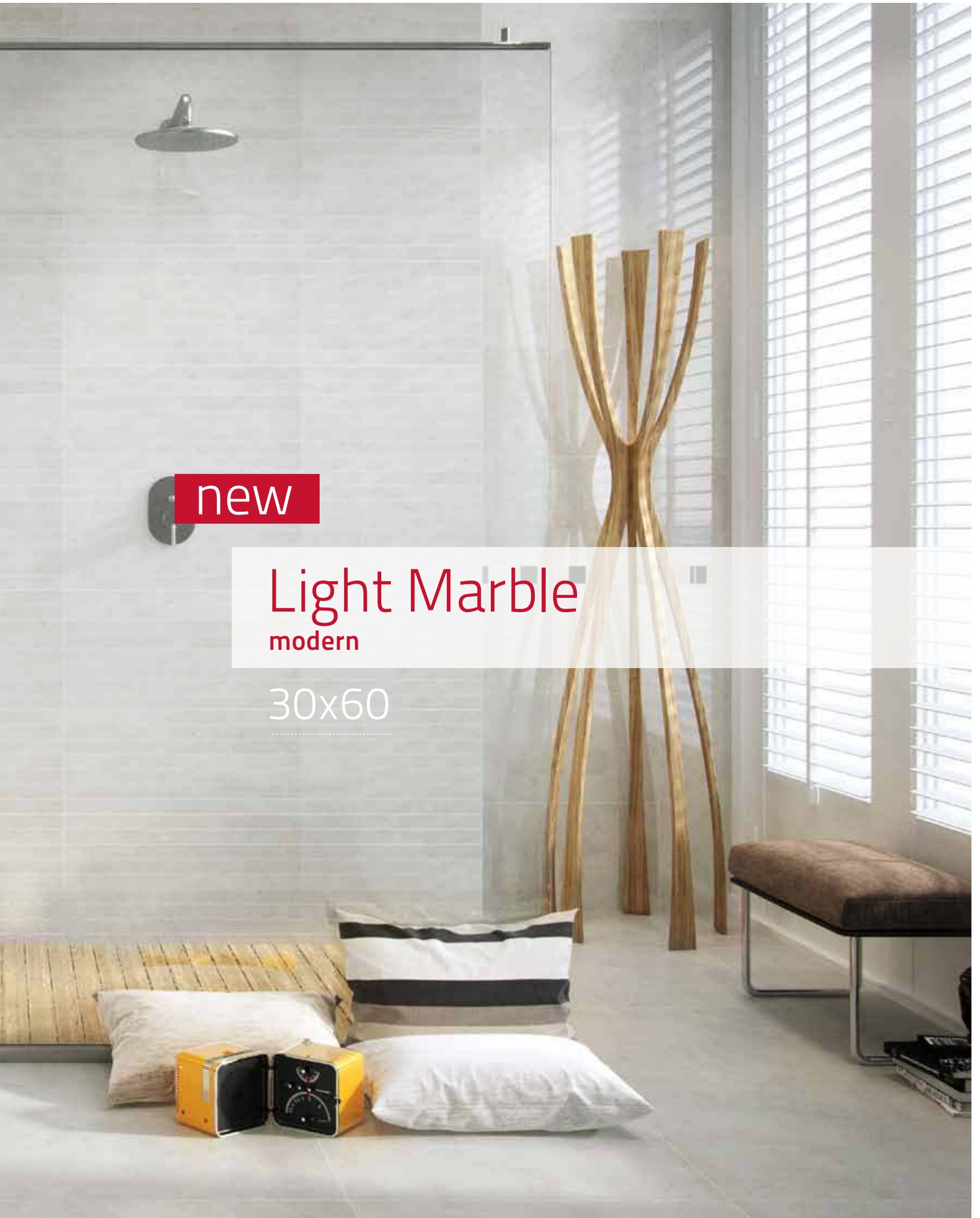



LIGHT MARBLE grey
29 x 59,3
OP636-011-1



LIGHT MARBLE grey mosaic belt
29 x 59,3
OD636-022

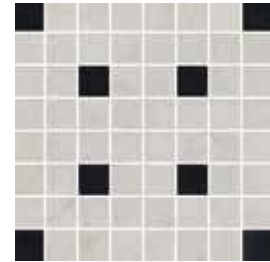

LIGHT MARBLE grey mosaic square
29 x 29
OD636-020



LIGHT MARBLE grey structure
29 x 59,3
OP636-012-1



LIGHT MARBLE grey stone border
4,8 x 59,3
OD636-026



GLASS grey border
2,3 x 59,3
OD636-023



LIGHT MARBLE grey inserto classic
29 x 59,3
OD636-028



LIGHT MARBLE grey
59,3 x 59,3
OP636-008-1



R10

5

p#
098
099

new

Light Marble
30x60



LIGHT MARBLE beige mosaic square
29 x 29
OD636-019



LIGHT MARBLE beige mosaic belt
29 x 59,3
OD636-021



LIGHT MARBLE beige
29 x 59,3
OP636-009-1



LIGHT MARBLE beige
59,3 x 59,3
OP636-007-1



LIGHT MARBLE beige structure
29 x 59,3
OP636-010-1



LIGHT MARBLE beige stone border
4,8 x 59,3
OD636-025

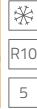

GLASS brown border
2,3 x 59,3
OD636-024



LIGHT MARBLE beige inserto classic
29 x 59,3
OD636-027













glossy tiles



structured tiles



rectified tiles

 cm	 cm	 pcs	 m ²	 kg	 kg/m ²	 m ²	 cm	 cm	 pcs
59,3x59,3	1	5	1,76	42,5	24,15	35,2	4,8x59,3	1	24
29x59,3	1,1	7	1,2	22,8	19,0	38,4	2,3x59,3	1	21
29x59,3 structure	1,1	7	1,2	22,8	19,0	38,4			
29x59,3 mosaic	1,1	6	-	-	-	-			
29x29 mosaic	1,1	12	-	-	-	-			



abrasion-resistance class



non-slip class



frost-resistant tile

p#
100
101

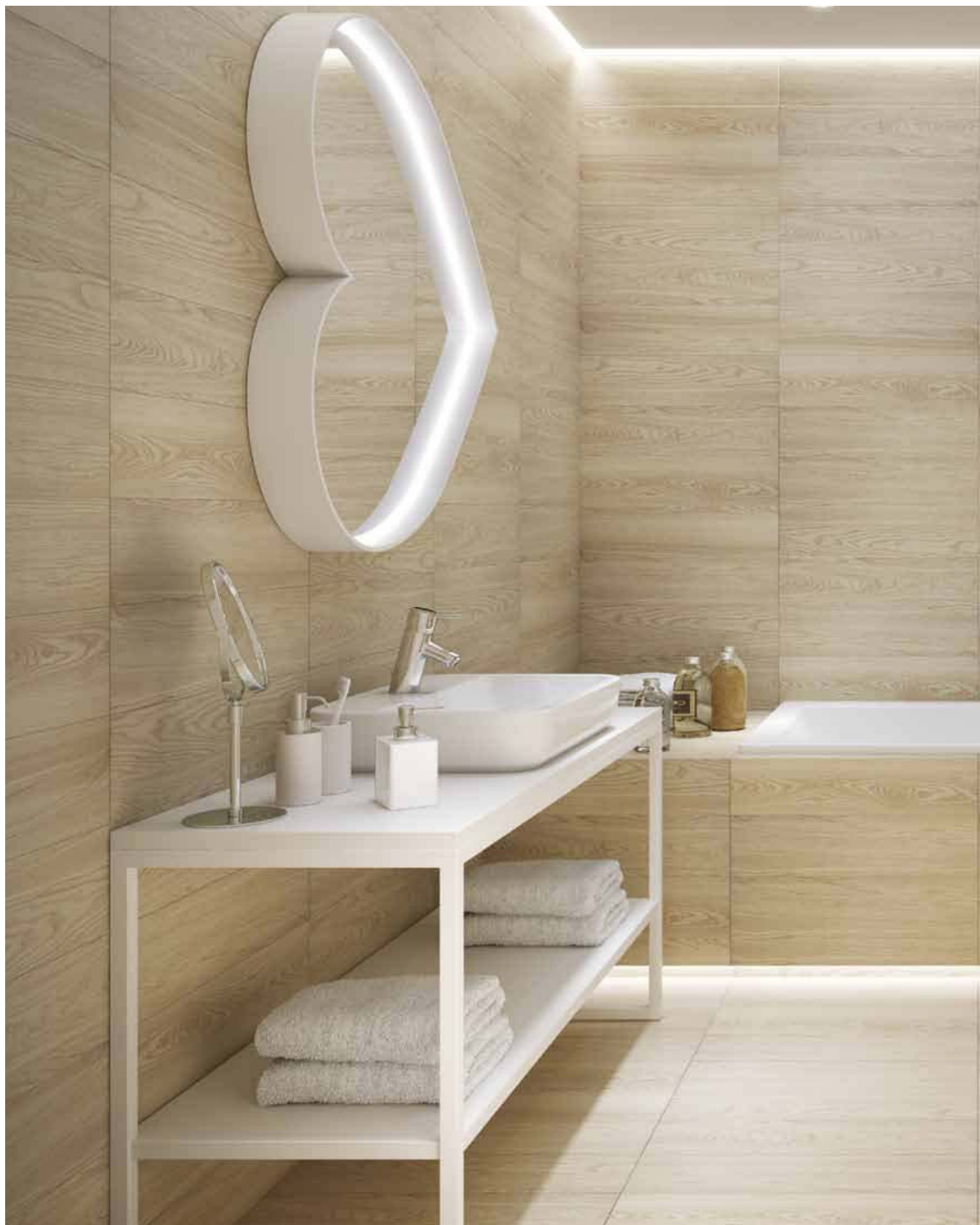

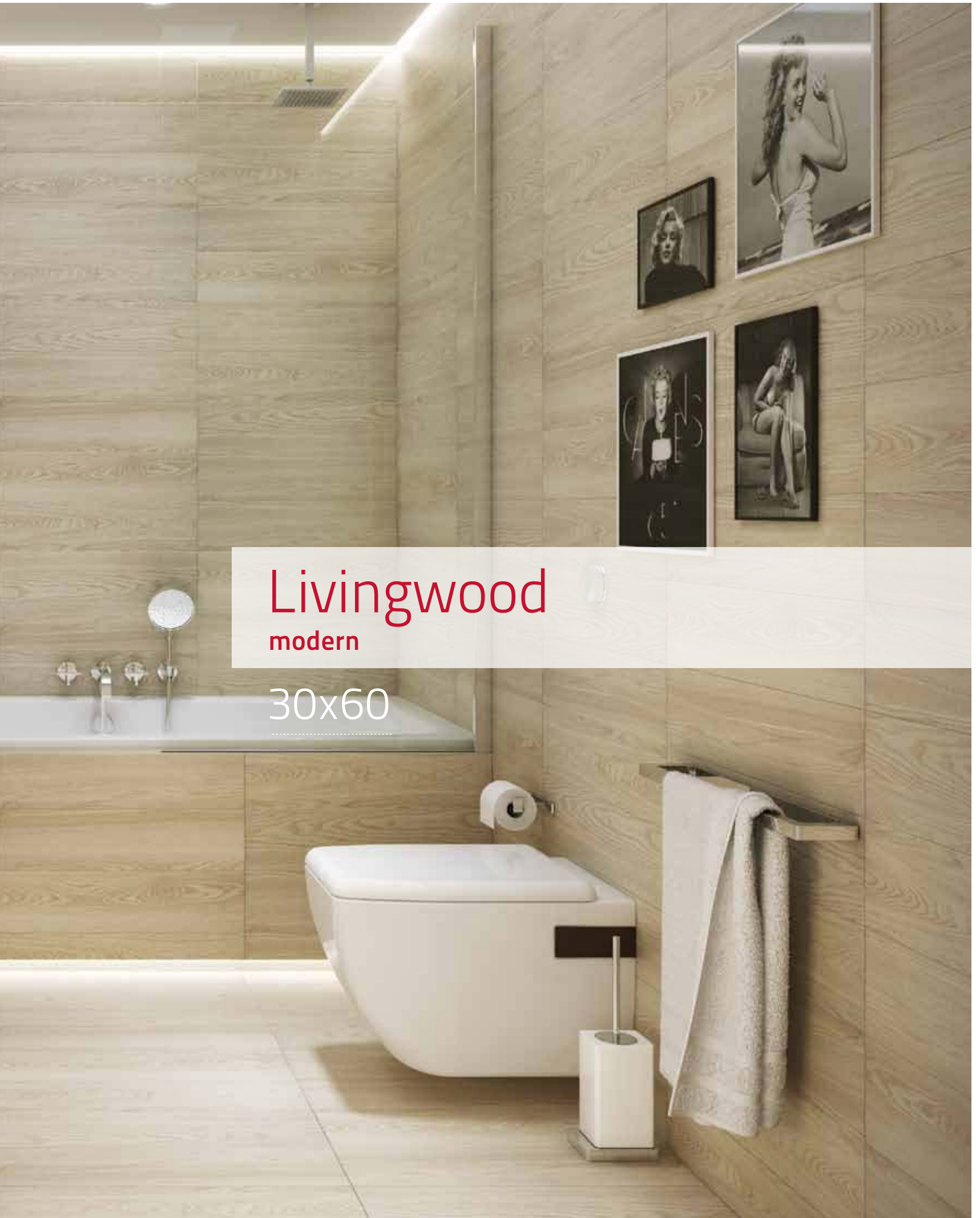

Livingwood

modern

30x60



p#
102
103

Livingwood

30x60



R9

4

LIVINGWOOD maple
14,4 x 59,3
OP364-004-1



R9

4

LIVINGWOOD maple
29 x 59,3
OP364-001-1



R9

3

LIVINGWOOD pine
14,4 x 59,3
OP364-005-1



R9

3

LIVINGWOOD pine
29 x 59,3
OP364-002-1



R9

3

LIVINGWOOD chestnut
14,4 x 59,3
OP364-006-1



R9

3

LIVINGWOOD chestnut
29 x 59,3
OP364-003-1



GLASS white border NEW
2 x 59,3
OD660-040



GLASS beige border NEW
2 x 59,3
OD660-042



GLASS brown border NEW
2 x 59,3
OD660-043



rectified
tiles



matt
tiles

cm	cm	pcs	m ²	kg	kg/m ²	m ³	cm	cm	pcs
29x59,3	1,00	7	1,2	28,50	23,75	38,40	2x59,3 glass	1	21
14,4x59,3	1,00	8	0,68	16,15	23,75	28,56			

4 3

abrasion-resistance class

R9

non-slip class



frost-resistant tile



p#
104
105



Metallic
modern

30x60



p#
106
107

Metallic
30x60



METALIC graphite silver
29,7 x 59,8
OP011-010-1



METALIC white
29,7 x 59,8
OP011-004-1



ZEBRA black border glass
6 x 59,8
OD011-017



METALIC graphite
29,7 x 59,8
OP011-009-1



METALIC silver cigar
2 x 59,8
OD011-012



GLASS white border NEW
2 x 60
OD660-025



GLASS white border NEW
4,8 x 60
OD660-009



GLASS heather border NEW
2 x 60
OD640-005



GLASS heather border NEW
4,8 x 60
OD660-015



GLASS silver border NEW
2 x 60
OD660-029



GLASS silver border NEW
4,8 x 60
OD660-013



GLASS black border NEW
2 x 60
OD660-026



GLASS black border NEW
4,8 x 60
OD660-010

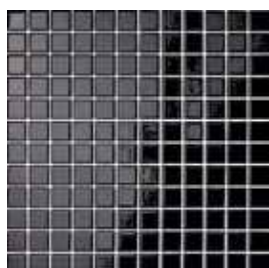

PALETTE black glossy mosaic
30 x 30
OP041-005-1

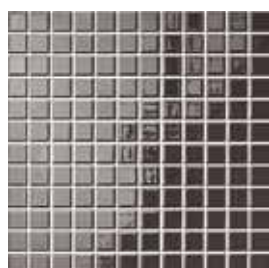

PALETTE graphite glossy mosaic
30 x 30
OP041-007-1



METALIC white
29,7 x 29,7
OP011-003-1



METALIC graphite
29,7 x 29,7
OP011-008-1



glossy tiles



structured tiles

cm	cm	pcs	m ²	kg	kg/m ²	m ²	cm	cm	pcs
29,7x59,8	0,85	9	1,6	30,5	19,06	51,2	2x59,8	1	8
29,7x29,7	0,8	15	1,32	22,15	16,78	58,08	6x59,8	0,8	6
30x30 mosaic	0,60	12	1,08	12,1	11,2	38,88	2x60 glass	1	21
							4,8x60 glass	1	7

4 2

abrasion-resistance class

R9

non-slip class



frost-resistant tile



p#
108
109



Black&White

modern

20x50



p#
110
111

Black&White

20x50

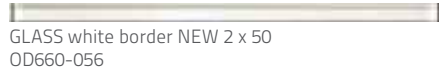

GLASS white border NEW 2 x 50
OD660-056



GLASS silver border NEW 2 x 50
OD660-060



GLASS black border NEW 2 x 50
OD660-057



GLASS orange border NEW 2 x 50
OD660-048



GLASS red border NEW 2 x 50
OD660-063



GLASS heather border NEW 2 x 50
OD660-062



GLASS azure border NEW 2 x 50
OD660-052



GLASS light green border NEW 2 x 50
OD660-050

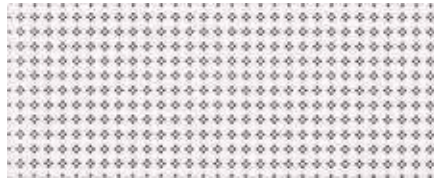

BLACK&WHITE pattern A
20 x 50
OP399-003-1

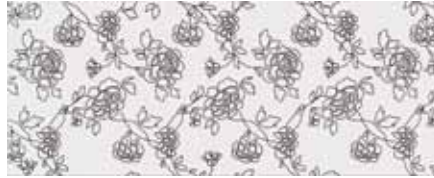

BLACK&WHITE pattern C
20 x 50
OP399-005-1



BLACK&WHITE pattern E
20 x 50
OP399-009-1

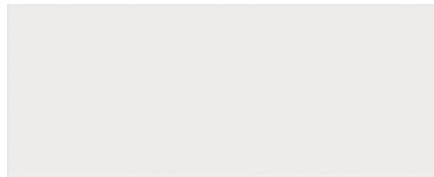

WHITE satin
20 x 50
OP399-001-1

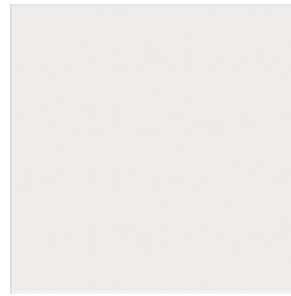

WHITE satin
33,3 x 33,3
OP399-007-1

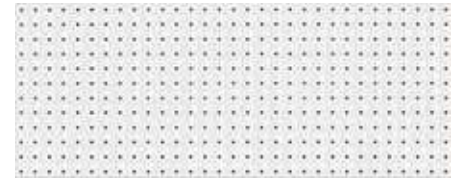

BLACK&WHITE pattern B
20 x 50
OP399-004-1

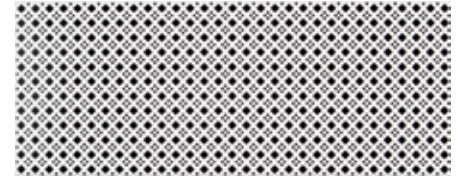

BLACK&WHITE pattern D
20 x 50
OP399-006-1

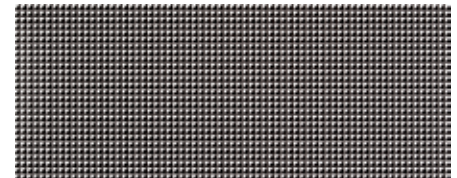

BLACK&WHITE pattern F
20 x 50
OP399-010-1



BLACK satin
20 x 50
OP399-002-1



BLACK satin
33,3 x 33,3
OP399-008-1



matt
tiles

cm	cm	pcs	m ²	kg	kg/m ²	m ²	cm	cm	pcs
20x50	0,90	13	1,3	22,63	17,41	46,80	2x50 glass	0,8	10
33,3x33,3	0,80	12	1,33	23,41	17,60	63,84			

p#
112
113





Capri
modern

20x50



CAPRI cream
20 x 50
OP015-007-1



CAPRI violet
20 x 50
OP015-006-1

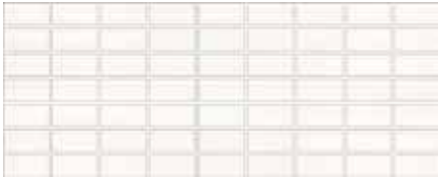

CAPRI cream mosaic
20 x 50
OD015-025

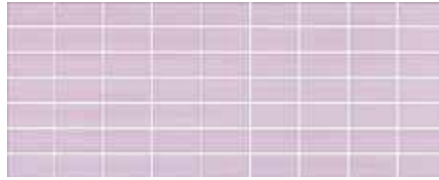

CAPRI violet mosaic
20 x 50
OD015-024

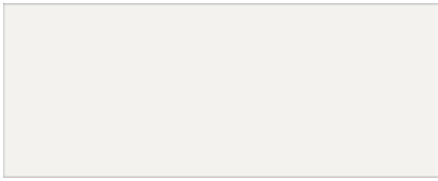

WHITE glossy
20 x 50
OP018-001-1



CAPRI orange
20 x 50
OP015-008-1

p#
114
115

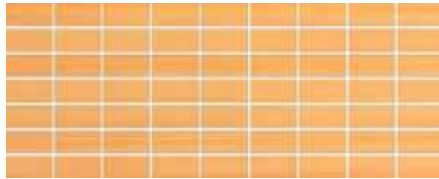

CAPRI orange mosaic
20 x 50
OD015-026

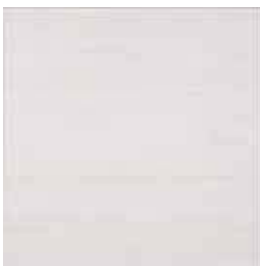

CAPRI cream
29,7 x 29,7
OP015-003-1



3



CAPRI violet
29,7 x 29,7
OP015-002-1



3



CAPRI orange
29,7 x 29,7
OP015-004-1



3

Capri
20x50



CAPRI orange inserto flower
20 x 50
OD015-014



CAPRI violet inserto flower
20 x 50
OD015-011



CAPRI brown inserto flower
20 x 50
OD015-009



CAPRI cream inserto flower
20 x 50
OD015-013



CAPRI orange border
2,5 x 50
OD015-021



CAPRI orange border mosaic
5,5 x 50
OD015-022



CAPRI brown border
2,5 x 50
OD015-016



CAPRI brown border mosaic
5,5 x 50
OD015-017



CAPRI violet border
2,5 x 50
OD015-018













CAPRI violet border mosaic
5,5 x 50
OD015-019



CAPRI cream border
2,5 x 50
OD015-020



 cm	 cm	 pcs	 m ²	 kg	 kg/m ²	 m ²	 cm	 cm	 pcs
20x50	0,9	13	1,3	22,6	17,41	46,8	5,5x50	0,9	10
20x50 inserto	0,9	10	-	-	-	-	2,5x50	0,9	18
20x50 mosaic	0,9	10	-	-	-	-			
29,7x29,7	0,8	15	1,32	22,15	16,78	58,08			



p#
116
117



Cemento

modern

20x50



p#
118
119

Cemento
20x50

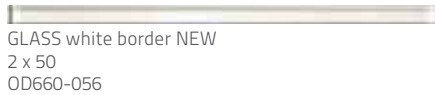

GLASS white border NEW
2 x 50
OD660-056



GLASS beige border NEW
2 x 50
OD660-058



GLASS black border NEW
2 x 50
OD660-057



GLASS red border NEW
2 x 50
OD660-063

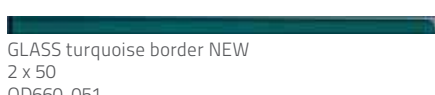

GLASS turquoise border NEW
2 x 50
OD660-051



CEMENTO grey
20 x 50
OP398-001-1



CEMENTO grey flower
20 x 50
OP398-002-1

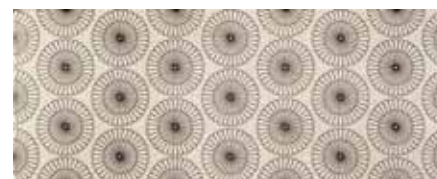

CEMENTO grey ornament
20 x 50
OP398-003-1



CEMENTO grey
33,3 x 33,3
OP398-004-1

3



cm	cm	pcs	m ²	kg	kg/m ²	m ²	cm	cm	pcs
20x50	0,9	13	1,3	22,63	17,41	46,80	2x50 glass	0,8	10
33,3x33,3	0,8	12	1,33	23,41	17,60	63,84			

p#
120
121





Fusion

modern

20x50

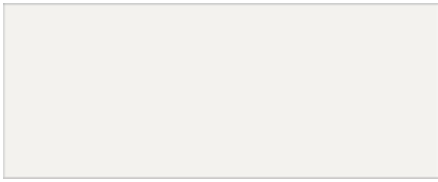

WHITE glossy
20 x 50
OP018-001-1



FUSION graphite inserto
20 x 50
OD016-012

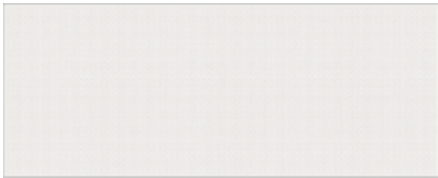

FUSION white
20 x 50
OP016-001-1



FUSION red inserto
20 x 50
OD016-011



FUSION white inserto
20 x 50
OD016-009



FUSION brown inserto
20 x 50
OD016-010

p#
122
123



4

FUSION white
33,3 x 33,3
OP016-005-1

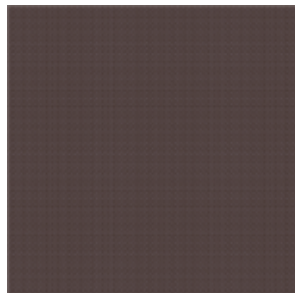

3

FUSION brown
33,3 x 33,3
OP016-006-1

Fusion

20x50



FUSION graphite
20 x 50
OP016-004-1

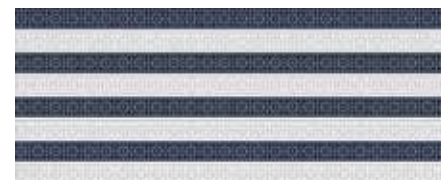

FUSION graphite mosaic
20 x 50
OD016-019



FUSION red
20 x 50
OP016-003-1

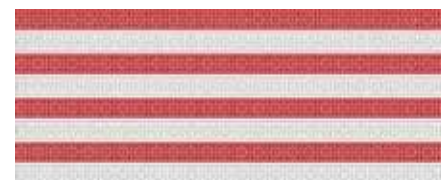

FUSION red mosaic
20 x 50
OD016-018



FUSION brown
20 x 50
OP016-002-1



FUSION brown mosaic
20 x 50
OD016-017



GLASS graphite border
2,3 x 50
OD016-020



FUSION white border
2,3 x 50
OD016-013



GLASS red border
2,3 x 50
OD016-022



FUSION graphite border
2,3 x 50
OD016-016



GLASS brown border
2,3 x 50
OD016-021



FUSION red border
2,3 x 50
OD016-015



FUSION brown border
2,3 x 50
OD016-014



cm	cm	pcs	m ²	kg	kg/m ²	m ²	cm	cm	pcs
20x50	0,9	13	1,3	22,63	17,41	46,8	2,3x50	1,0	18
20x50 inserto	0,9	10	-	-	-	-	2,3x50 glass	1,0	24
20x50 mosaic	0,9	10	-	-	-	-			
33,3x33,3	0,8	12	1,33	23,41	17,6	63,84			

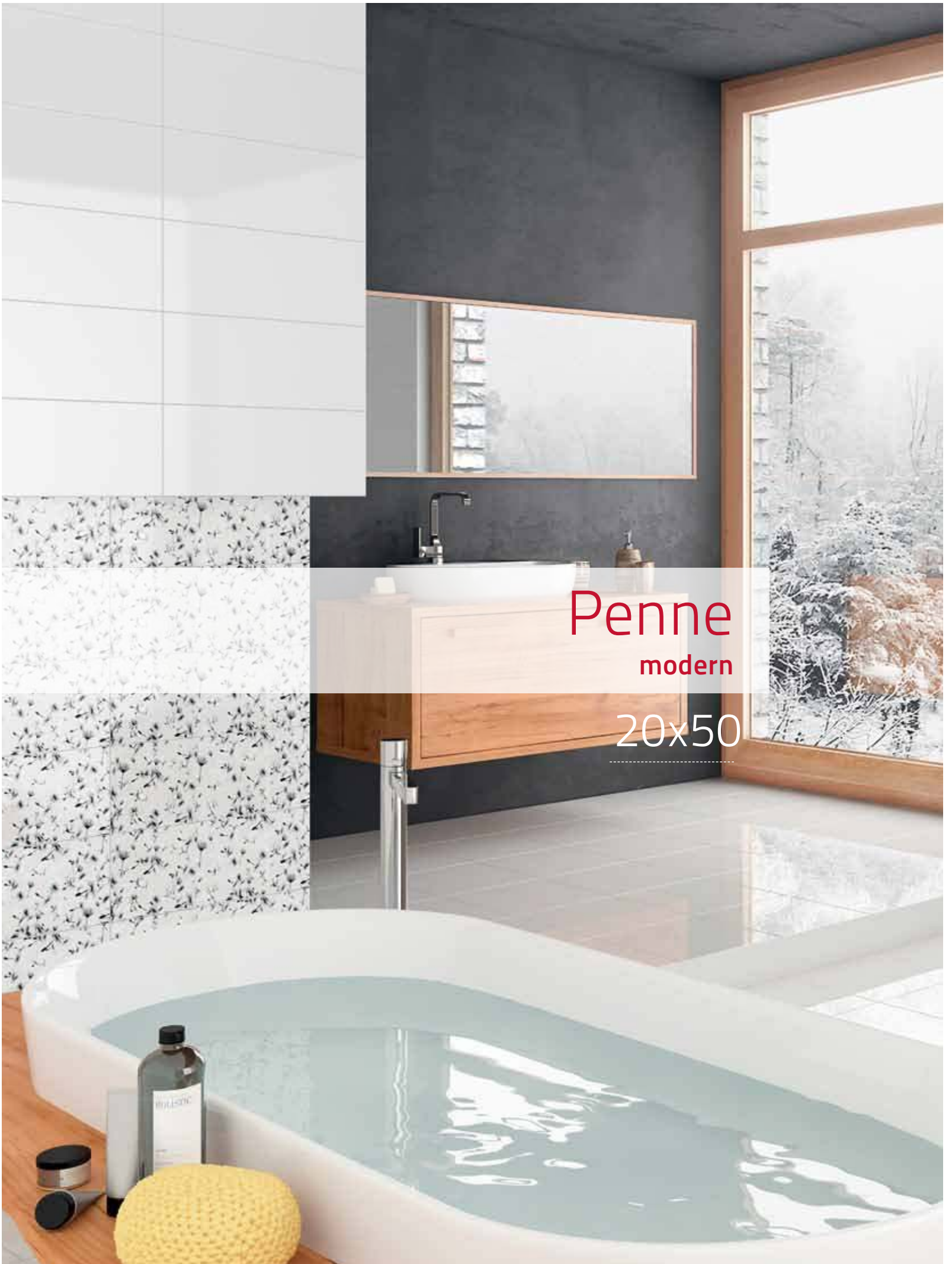

Penne
modern

20x50

p#
124
125



GLASS white border NEW
2 x 50
OD660-056



GLASS silver border NEW
2 x 50
OD660-060



GLASS yellow border NEW
2 x 50
OD660-049



GLASS black border NEW
2 x 50
OD660-057



PENNE inserto flower
20 x 50
OD018-007



PENNE border flower
8 x 50
OD018-013



PENNE border flower
2,5 x 50
OD018-012

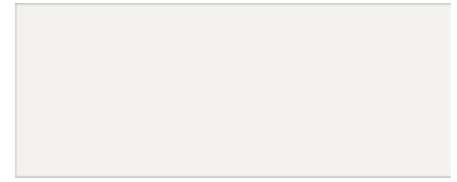

WHITE glossy
20 x 50
OP018-001-1



PENNE white
20 x 50
OP018-002-1

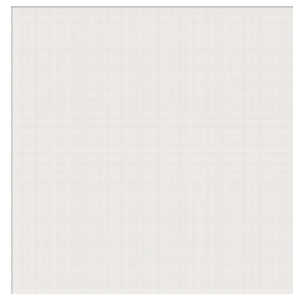

PENNE white
33,3 x 33,3
OP018-003-1

4



PENNE grey
33,3 x 33,3
OP018-004-1

3



cm	cm	pcs	m ²	kg	kg/m ²	m ²	cm	cm	pcs
20x50	0,9	13	1,3	22,63	17,41	46,8	8x50	1	6
20x50 inserto	0,9	10	-	-	-	-	2,5x50	1	18
33,3x33,3	0,8	12	1,33	23,41	17,6	63,84	2x50 glass	0,8	10



p#
126
127



Soft Ornament

modern

20x50



p#
128
129

Soft Ornament

20x50



GLASS white border NEW
2 x 50
OD660-056



GLASS silver border NEW
2 x 50
OD660-060



GLASS dark beige border NEW
2 x 50
OD660-055



GLASS cobalt border NEW
2 x 50
OD660-053

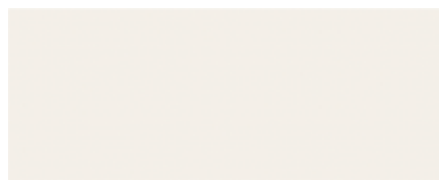

SOFT ORNAMENT white
20 x 50
OP614-012-1

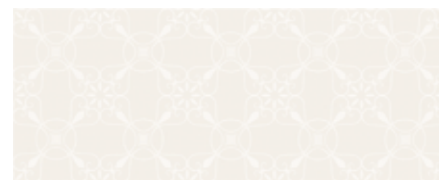

SOFT ORNAMENT white classic inserto
20 x 50
OD614-013

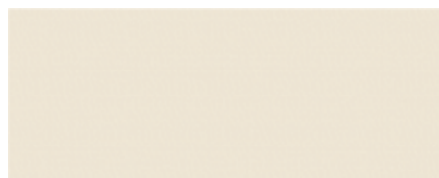

SOFT ORNAMENT beige
20 x 50
OP614-001-1



SOFT ORNAMENT beige classic inserto
20 x 50
OD614-004

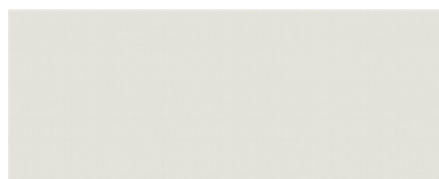

SOFT ORNAMENT grey
20 x 50
OP614-003-1

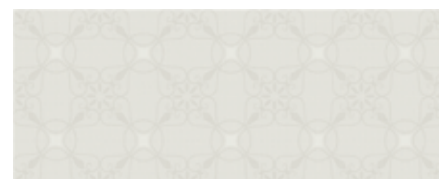

SOFT ORNAMENT grey classic inserto
20 x 50
OD614-008



SOFT ORNAMENT grey flower inserto
20 x 50
OD614-009



SOFT ORNAMENT beige flower inserto
20 x 50
OD614-005

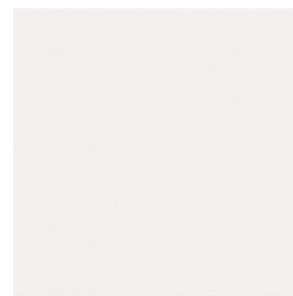

SOFT ORNAMENT white
33,3 x 33,3
OP614-014-1

3



matt
tiles

cm	cm	pcs	m ²	kg	kg/m ²	m ²	cm	cm	pcs
20x50	0,9	13	1,3	22,63	17,41	46,80	2x50 glass	0,8	10
20x50 inserto	0,9	10	-	-	-	-			
33,3x33,3	0,8	12	1,33	23,41	17,60	63,84			

p#
130
131





Sunny Wood

modern

20x50

p#
132
133

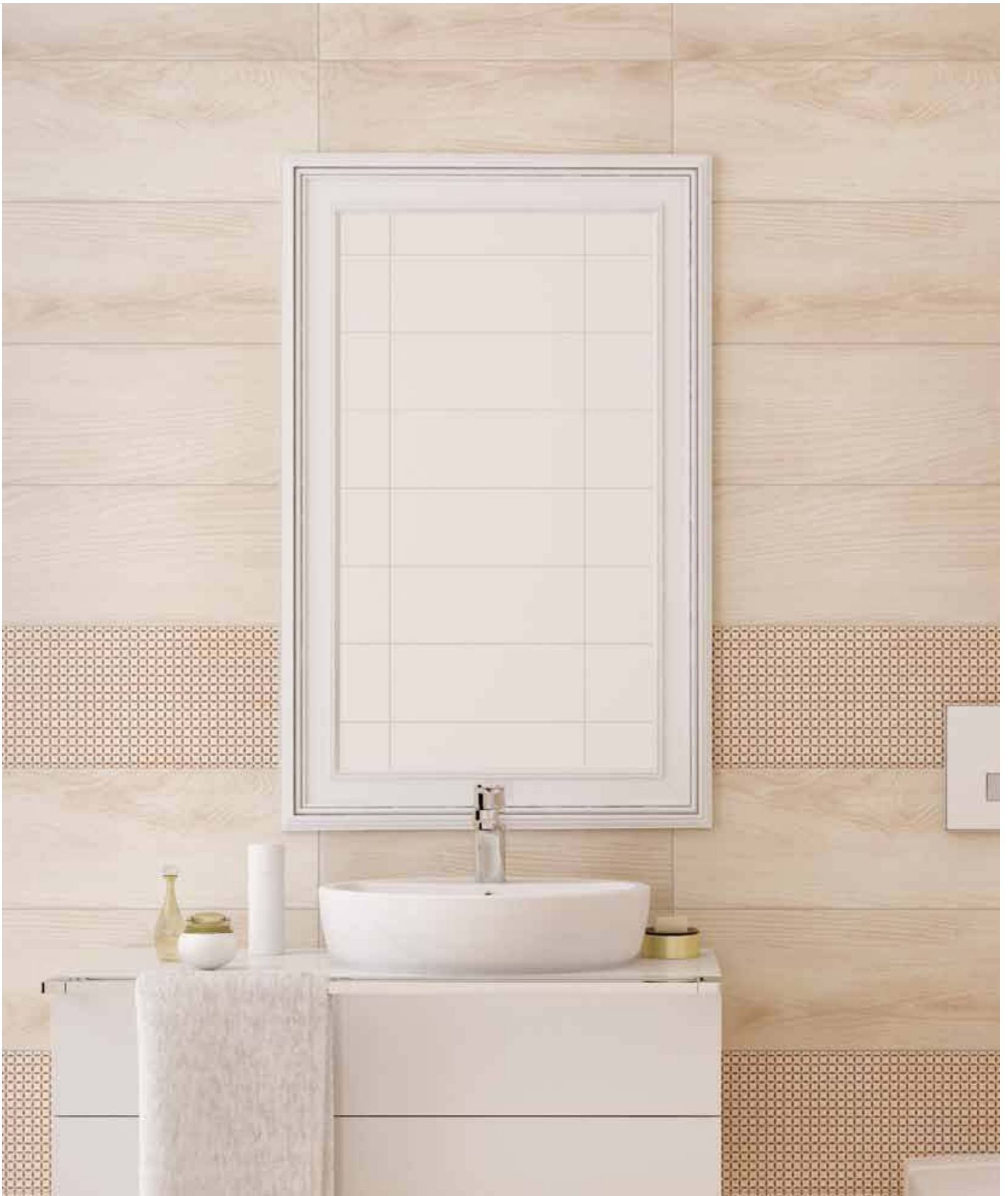

Sunny Wood
20x50



GLASS white border NEW
2 x 50
OD660-056



GLASS beige border NEW
2 x 50
OD660-058



GLASS dark beige border NEW
2 x 50
OD660-055



GLASS black border NEW
2 x 50
OD660-057



SUNNY WOOD beige
20 x 50
OP615-001-1

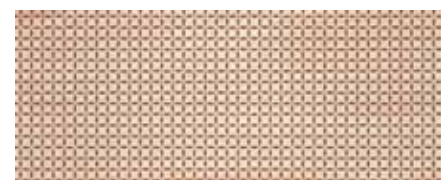

SUNNY WOOD beige pattern A
20 x 50
OP615-002-1



SUNNY WOOD beige pattern B
20 x 50
OP615-003-1



SUNNY WOOD beige
33,3 x 33,3
OP615-004-1

3

 matt tiles

 cm	 cm	 pcs	 m ²	 kg	 kg/m ²	 m ²	 cm	 cm	 pcs
20x50	0,9	13	1,3	22,63	17,41	46,80	2x50 glass	0,8	10
33,3x33,3	0,8	12	1,33	23,41	17,60	63,84			

p#
134
135





Baricello

modern

30x45

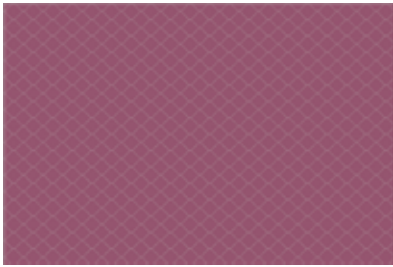

BARICELLO violet
30 x 45
OP021-003-1



BARICELLO brown
30 x 45
OP021-002-1

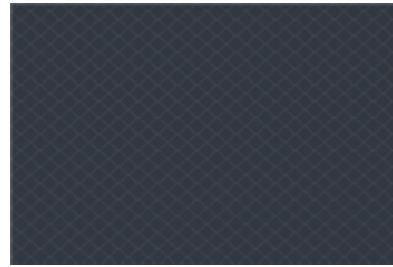

BARICELLO graphite
30 x 45
OP021-004-1



BARICELLO violet inserto classic
30 x 45
OD021-012



BARICELLO brown inserto classic
30 x 45
OD021-010



BARICELLO graphite inserto classic
30 x 45
OD021-014



BARICELLO violet border classic
7 x 45
OD021-018



BARICELLO brown border classic
7 x 45
OD021-017



BARICELLO graphite border classic
7 x 45
OD021-019



BARICELLO violet inserto flower
30 x 45
OD021-013



BARICELLO brown inserto flower
30 x 45
OD021-011



BARICELLO graphite inserto flower
30 x 45
OD021-015



GLASS white border NEW
2 x 45
OD660-072



GLASS beige border NEW
2 x 45
OD660-074



GLASS red border NEW
2 x 45
OD660-079



GLASS heather border NEW
2 x 45
OD660-078



GLASS brown border NEW
2 x 45
OD660-075



GLASS black border NEW
2 x 45
OD660-073

p#
136
137

Baricello

30x45



BARICELLO white border classic
7 x 45
OD021-016



SILVER border
0,6 x 30
OD021-020

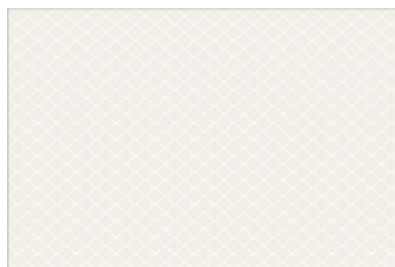

BARICELLO white
30 x 45
OP021-001-1

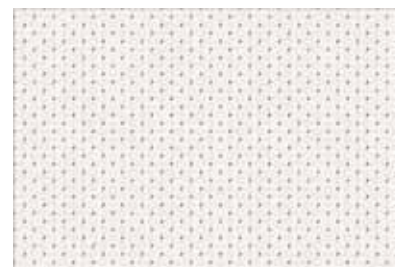

BARICELLO white inserto classic
30 x 45
OD021-009

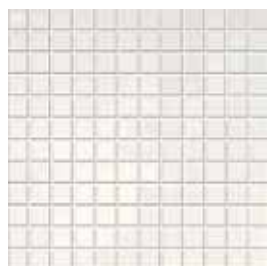

PALETTE white glossy mosaic
30 x 30
OP041-002-1

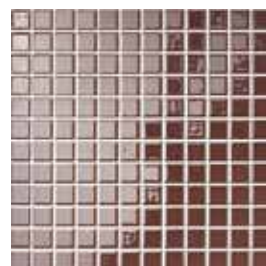

PALETTE brown glossy mosaic
30 x 30
OP041-003-1

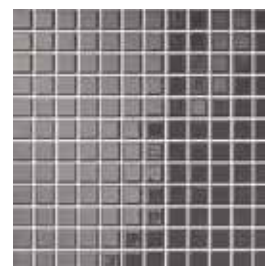

PALETTE grey glossy mosaic
30 x 30
OP041-010-1

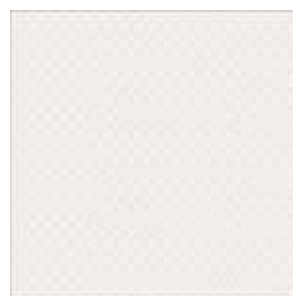

BARICELLO white
33,3 x 33,3
OP021-005-1

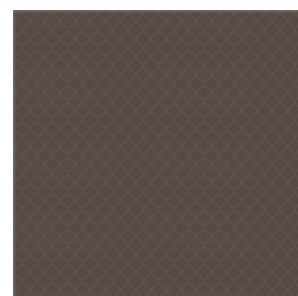

BARICELLO brown
33,3 x 33,3
OP021-006-1



glossy
tiles

cm	cm	pcs	m ²	kg	kg/m ²	m ²	cm	cm	pcs
30x45	0,9	10	1,35	20,86	15,45	45,90	7x45	0,9	5
30x45 inserto	0,9	5	–	–	–	–	0,6x30	0,9	50
33,3x33,3	0,8	12	1,33	23,41	17,6	63,84	2x45 glass	0,8	10
30x30	0,6	12	1,08	12,1	11,2	38,88			

p#
138
139





Calipso
modern

30x45



CALIPSO green
30 x 45
OP022-008-1

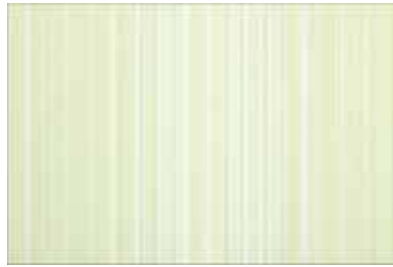

CALIPSO light green
30 x 45
OP022-006-1



CALIPSO light green inserto classic
30 x 45
OD022-015

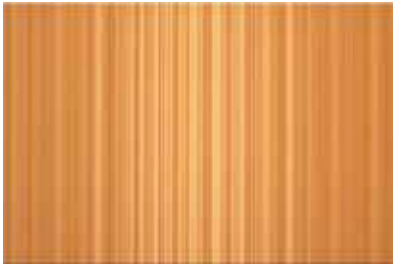

CALIPSO orange
30 x 45
OP022-005-1



CALIPSO beige
30 x 45
OP022-001-1



CALIPSO beige inserto classic
30 x 45
OD022-013



CALIPSO graphite
30 x 45
OP022-003-1



CALIPSO grey
30 x 45
OP022-007-1



CALIPSO grey inserto classic
30 x 45
OD022-016



GLASS white border NEW
2 x 45
OD660-072



GLASS light green border NEW
2 x 45
OD660-066



GLASS orange border NEW
2 x 45
OD660-064



GLASS black border NEW
2 x 45
OD660-073



CALIPSO cream
30 x 45
OP022-004-1



CALIPSO cream inserto classic
30 x 45
OD022-014

p#
140
141

Calipso

30x45

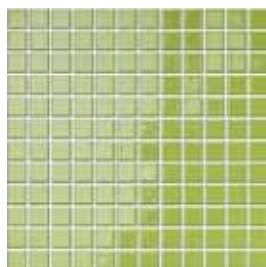

PALETTE green glossy mosaic
30 x 30
OP041-011-1



PALETTE brown-gold glossy mosaic
30 x 30
OP041-004-1

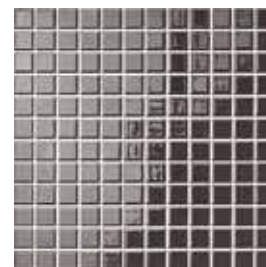

PALETTE graphite glossy mosaic
30 x 30
OP041-007-1



CALIPSO green border mosaic
2,8 x 45
OD022-020



CALIPSO brown border mosaic
2,8 x 45
OD022-017



CALIPSO orange border mosaic
2,8 x 45
OD022-019



CALIPSO graphite border mosaic
2,8 x 45
OD022-018



CALIPSO green
33,3 x 33,3
OP022-012-1



CALIPSO orange
33,3 x 33,3
OP022-011-1



CALIPSO graphite
33,3 x 33,3
OP022-010-1



cm	cm	pcs	m ²	kg	kg/m ²	m ²	cm	cm	pcs
30x45	0,9	10	1,35	20,86	15,45	45,90	2,8 x 45	0,9	10
30x45 inserto classic	0,9	5	–	–	–	–	2x45 glass	0,8	10
30x30 mosaic	0,6	12	1,08	12,1	11,2	38,88			
33,3x33,3	0,8	12	1,33	23,41	17,6	63,84			

p#
142
143





new

Desert Storm

modern

30x45

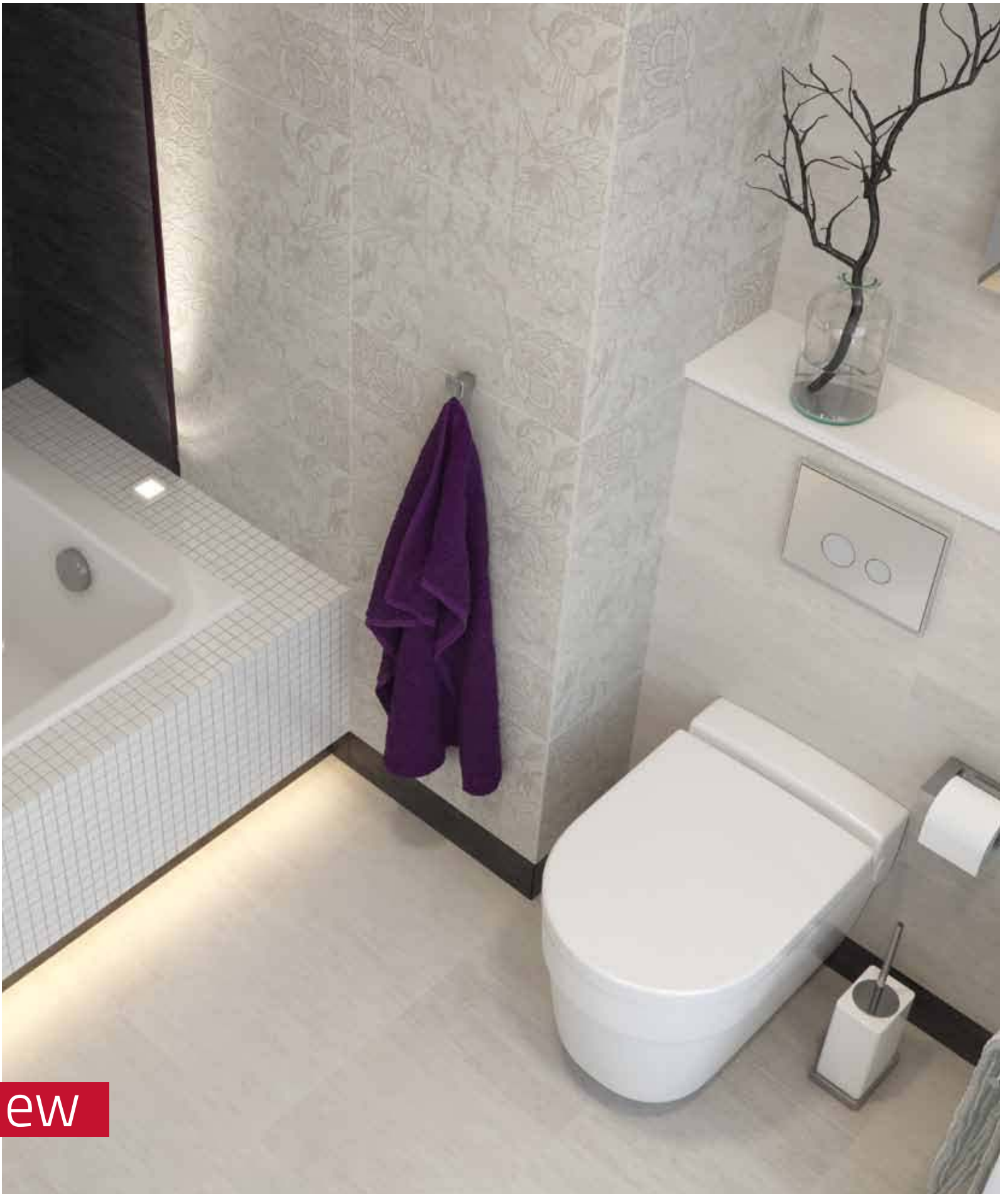

p#
144
145

new

Desert Storm

30x45



DESERT STORM grey
30 x 45
OP633-001-1



DESERT STORM graphite
30 x 45
OP633-002-1



DESERT STORM grey inserto
30 x 45
OD633-004



DESERT STORM graphite inserto
30 x 45
OD633-005



GLASS white border NEW
2 x 45
OD660-072



GLASS red border NEW
2 x 45
OD660-079



GLASS silver border NEW
2 x 45
OD660-076



GLASS violet border NEW
2 x 45
OD660-070



GLASS heather border NEW
2 x 45
OD660-078



DESERT STORM grey
33,3 x 33,3
OP633-003-1

3



cm	cm	pcs	m ²	kg	kg/m ²	m ²	cm	cm	pcs
30x45	0,9	10	1,35	20,86	15,45	45,90	2x45 glass	0,8	10
30x45 inserto	0,9	5	-	-	-	-			
33,3x33,3	0,8	12	1,33	23,41	17,6	63,84			



p#
146
147

Fiji
modern

30x45



FIJI cream
30 x 45
OP023-003-1



FIJI cream inserto orient
30 x 45
OD023-012

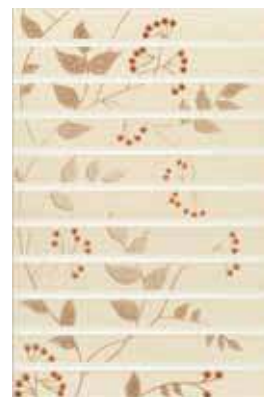

FIJI cream inserto classic
30 x 45
OD023-010



FIJI brown
30 x 45
OP023-002-1



FIJI brown inserto orient
30 x 45
OD023-009



FIJI brown inserto classic
30 x 45
OD023-007



FIJI cream
33,3 x 33,3
OP023-006-1

3



FIJI brown
33,3 x 33,3
OP023-005-1

3

matt tiles

cm	cm	pcs	m ²	kg	kg/m ²	m ²	cm	cm	pcs
30x45	0,9	10	1,35	20,86	15,45	45,9			
30x45 inserto	0,9	5	-	-	-	-			
33,3x33,3	0,8	12	1,33	23,41	17,6	63,84			



p#
148
149



Lorena
modern

30x45



LORENA orange inserto flower A
30 x 45
OD025-018



LORENA orange inserto flower B
30 x 45
OD025-019



LORENA orange inserto flower C
30 x 45
OD025-020



LORENA orange
30 x 45
OP025-004-1



LORENA brown inserto flower A
30 x 45
OD025-010



LORENA brown inserto flower B
30 x 45
OD025-011



LORENA brown inserto flower C
30 x 45
OD025-012



LORENA brown
30 x 45
OP025-002-1



LORENA violet inserto flower A
30 x 45
OD025-014



LORENA violet inserto flower B
30 x 45
OD025-015



LORENA violet inserto flower C
30 x 45
OD025-016



LORENA violet
30 x 45
OP025-003-1

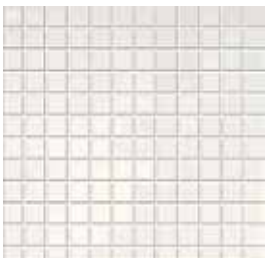

PALETTE white glossy mosaic
30 x 30
OP041-002-1

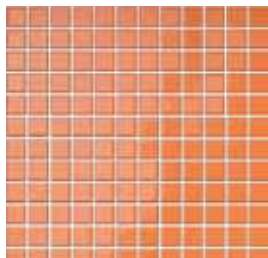

PALETTE orange glossy mosaic
30 x 30
OP041-009-1

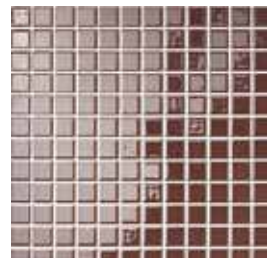

PALETTE brown glossy mosaic
30 x 30
OP041-003-1

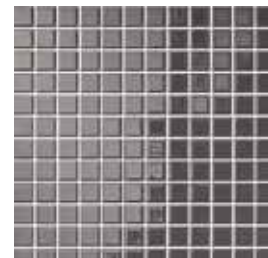

PALETTE grey glossy mosaic
30 x 30
OP041-010-1

p#
150
151

Lorena

30x45



LORENA grey inserto flower A
30 x 45
OD025-022



LORENA grey inserto flower B
30 x 45
OD025-023



LORENA grey inserto flower C
30 x 45
OD025-024



LORENA grey
30 x 45
OP025-005-1



LORENA orange border wave
4,8 x 45
OD025-033



LORENA brown border wave
4,8 x 45
OD025-027



LORENA orange border wave
5 x 30
OD025-032



LORENA brown border wave
5 x 30
OD025-026



LORENA violet border wave
4,8 x 45
OD025-030



LORENA grey border wave
4,8 x 45
OD025-036



LORENA violet border wave
5 x 30
OD025-029



LORENA grey border wave
5 x 30
OD025-035



LORENA white
30 x 45
OP025-001-1

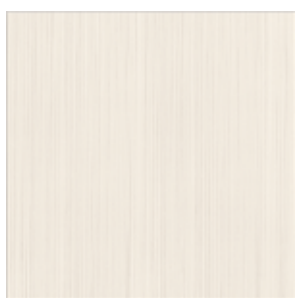

LORENA white
33,3 x 33,3
OP025-006-1



LORENA orange
33,3 x 33,3
OP025-008-1

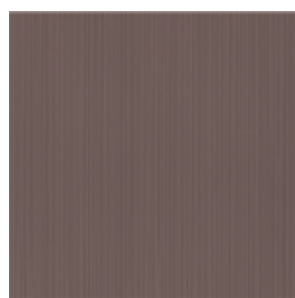

LORENA brown
33,3 x 33,3
OP025-007-1



LORENA grey
33,3 x 33,3
OP025-009-1



glossy
tiles

cm	cm	pcs	m ²	kg	kg/m ²	m ²	cm	cm	pcs
30x45	0,9	10	1,35	20,86	15,45	45,90	4,8x45	0,9	8
30x45 inserto	0,9	5	-	-	-	-	5x30	0,9	5
30x30 mosaic	0,6	12	1,08	12,1	11,2	38,88			
33,3x33,3	0,8	12	1,33	23,41	17,6	63,84			

p#
152
153





new

Sandy Wind
modern

30x45



p#
154
155

new

Sandy Wind

30x45



SANDY WIND beige
30 x 45
OP634-001-1



SANDY WIND brown
30 x 45
OP634-002-1



SANDY WIND beige inserto
30 x 45
OD634-004



SANDY WIND brown inserto
30 x 45
OD634-005



GLASS white border NEW
2 x 45
OD660-072



PEARL cream border
0,9 x 30
OD634-006



GLASS beige border NEW
2 x 45
OD660-074



PEARL brown border
0,9 x 30
OD633-007



GLASS dark beige border NEW
2 x 45
OD660-071



GLASS black border NEW
2 x 45
OD660-073













GLASS violet border NEW
2 x 45
OD660-070



SANDY WIND beige
33,3 x 33,3
OP634-003-1

3

 matt tiles

 cm	 cm	 pcs	 m ²	 kg	 kg/m ²	 m ²	 cm	 cm	 pcs
30x45	0,9	10	1,35	20,86	15,45	45,90	0,9x30	1	25
30x45 inserto	0,9	5	-	-	-	-	2x45 glass	0,8	10
33,3x33,3	0,8	12	1,33	23,41	17,60	63,84			



p#
156
157



new

Sea Mist

modern

30x45



p#
158
159

new

Sea Mist

30x45



SEA MIST cream
30 x 45
OP632-001-1



SEA MIST grey
30 x 45
OP632-002-1



SEA MIST cream inserto
30 x 45
OD632-006



SEA MIST grey inserto
30 x 45
OD632-007



GLASS white border NEW
2 x 45
OD660-072



SEA MIST cream border
4,8 x 45
OD632-008



GLASS silver border NEW
2 x 45
OD660-076

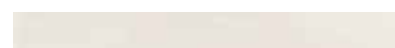

SEA MIST grey border
4,8 x 45
OD632-009



GLASS violet border NEW
2 x 45
OD660-070



GLASS azure border NEW
2 x 45
OD660-068



SANDY WIND beige
33,3 x 33,3
OP632-003-1

3



cm	cm	pcs	m ²	kg	kg/m ²	m ²	cm	cm	pcs
30x45	0,9	10	1,35	20,86	15,45	45,90	4,8x45	0,9	8
30x45 inserto	0,9	5	-	-	-	-	2x45 glass	0,8	10
33,3x33,3	0,8	12	1,33	23,41	17,60	63,84			

p#
160
161





Zebrano

modern

30x45





ZEBRANO cream inserto classic
30 x 45
OD028-008



ZEBRANO brown inserto classic
30 x 45
OD028-005



GLASS white border NEW
2 x 45
OD660-072



GLASS red border NEW
2 x 45
OD660-079



GLASS brown border NEW
2 x 45
OD660-075



ZEBRANO cream border classic
14,9 x 45
OD028-016



ZEBRANO brown border classic
14,9 x 45
OD028-011



ZEBRANO cream border classic
7 x 45
OD028-017



ZEBRANO brown border classic
7 x 45
OD028-012



ZEBRANO cream border classic
5,4 x 30
OD028-015



ZEBRANO brown border classic
5,4 x 30
OD028-010

p#
162
163



4

ZEBRA cream
33,3 x 33,3
OP028-004-1



2

ZEBRA brown
33,3 x 33,3
OP028-003-1

Zebrano

30x45



ZEBRANO cream
30 x 45
OP028-002-1



ZEBRANO brown
30 x 45
OP028-001-1



ZEBRANO cream inserto flower
30 x 45
OD028-009



ZEBRANO brown inserto flower
30 x 45
OD028-006

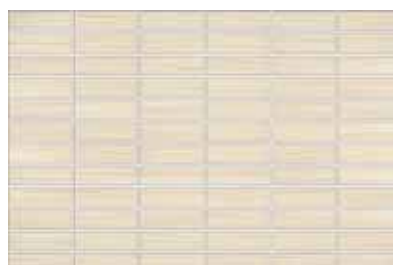

ZEBRANO cream mosaic
30 x 45
OD028-019

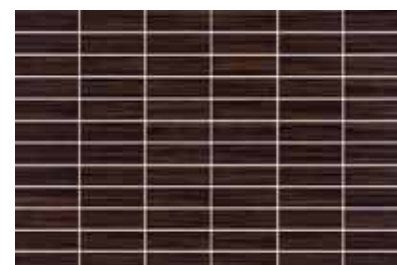

ZEBRANO brown mosaic
30 x 45
OD028-018



ZEBRANO brown border modern
7 x 45
OD028-014



ZEBRANO brown border modern
5,4 x 30
OD028-013



ZEBRANO brown inserto modern
30 x 45
OD028-007

matt tiles

cm	cm	pcs	m ²	kg	kg/m ²	m ²	cm	cm	pcs
30x45	0,9	10	1,35	20,86	15,45	45,9	14,9x45	0,9	10
30x45 inserto	0,9	5	-	-	-	-	7x45	0,9	5
30x45 mosaic	0,9	6	-	-	-	-	5,4 x30	0,9	5
33,3x33,3	0,8	12	1,33	23,41	17,6	63,84	2x45 glass	0,8	10

p#
164
165





Palette

modern

30x30



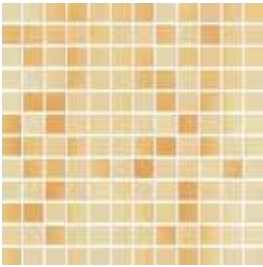

3

PALETTE beige mat mix mosaic
30 x 30
OP041-016-1

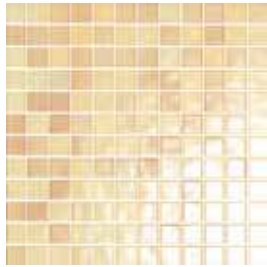

PALETTE beige mix glossy mosaic
30 x 30
OP041-013-1

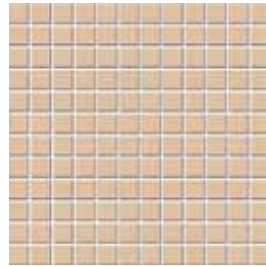

3

PALETTE beige mat mosaic
30 x 30
OP041-021-1

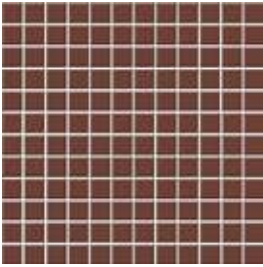

3

PALETTE brown mat mosaic
30 x 30
OP041-022-1

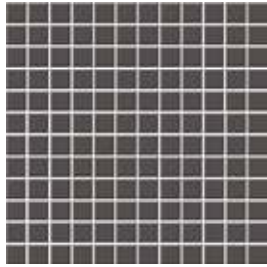

3

PALETTE grey mat mosaic
30 x 30
OP041-020-1

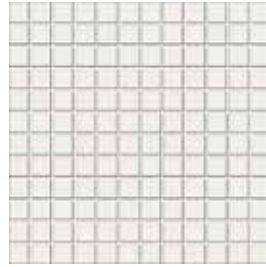

3

PALETTE white mat mosaic
30 x 30
OP041-019-1

p#
166
167

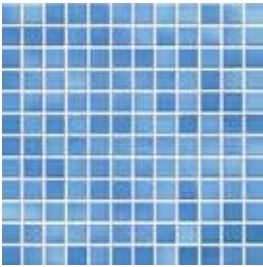

3

PALETTE blue mat mix mosaic
30 x 30
OP041-018-1

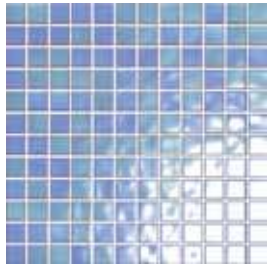

PALETTE blue mix glossy mosaic
30 x 30
OP041-015-1

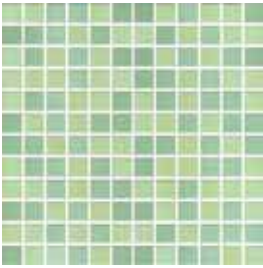

3

PALETTE green mat mix mosaic
30 x 30
OP041-017-1

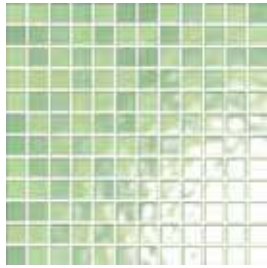

PALETTE green mix glossy mosaic
30 x 30
OP041-014-1

Palette

30x30

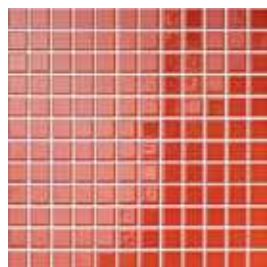

PALETTE red glossy mosaic
30 x 30
OP041-006-1



PALETTE brown-gold glossy mosaic
30 x 30
OP041-003-1

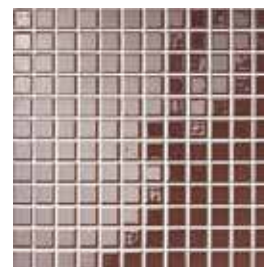

PALETTE brown glossy mosaic
30 x 30
OP041-004-1

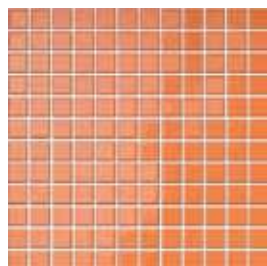

PALETTE orange glossy mosaic
30 x 30
OP041-009-1

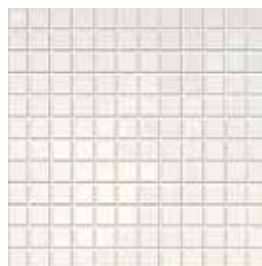

PALETTE white glossy mosaic
30 x 30
OP041-002-1

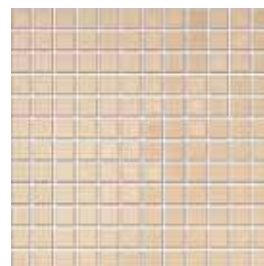

PALETTE beige glossy mosaic
30 x 30
OP041-001-1

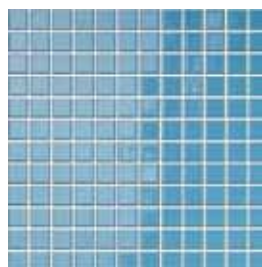

PALETTE blue glossy mosaic
30 x 30
OP041-008-1

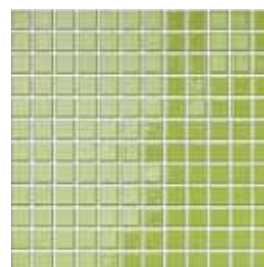

PALETTE green glossy mosaic
30 x 30
OP041-011-1

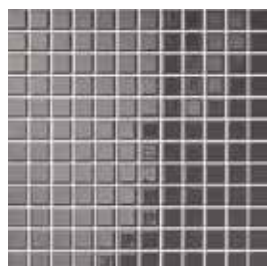

PALETTE grey glossy mosaic
30 x 30
OP041-010-1

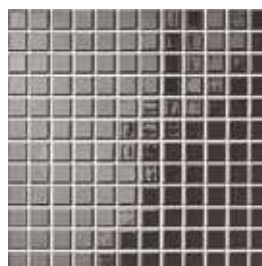

PALETTE graphite glossy mosaic
30 x 30
OP041-007-1

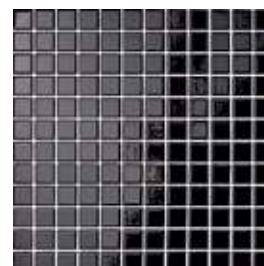

PALETTE black glossy mosaic
30 x 30
OP041-005-1



glossy tiles



matt tiles

cm	cm	pcs	m ²	kg	kg/m ²	m ²	cm	cm	pcs
30x30	0,60	12	1,08	12,1	11,2	38,88			

3

abrasion-resistance class



frost-resistant tile

p#
168
169



A modern bathroom interior featuring a white vanity with a square sink and a chrome faucet. Two amber-colored bottles are on the vanity. The background shows a shower area with a glass door and a showerhead. The walls are covered in large, dark grey tiles. A white medicine cabinet is mounted on the wall above the vanity. The floor is made of light-colored wood-look planks. A semi-transparent white banner with red text is overlaid on the image.

Colour Connection

modern

20x20



p#
170
171

Colour Connection

20x20



COLOUR CONNECTION
black-cream inserto A
20 x 20
OD627-003



COLOUR CONNECTION
red-cream inserto A
20 x 20
OD627-007



COLOUR CONNECTION
grey-red inserto A
20 x 20
OD627-005

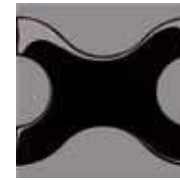

COLOUR CONNECTION
grey-black inserto A
20 x 20
OD627-001

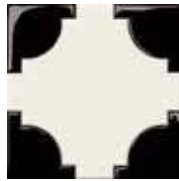

COLOUR CONNECTION
black-cream inserto B
20 x 20
OD627-004



COLOUR CONNECTION
red-cream inserto B
20 x 20
OD627-008



COLOUR CONNECTION
grey-red inserto B
20 x 20
OD627-006



COLOUR CONNECTION
grey-black inserto B
20 x 20
OD627-002

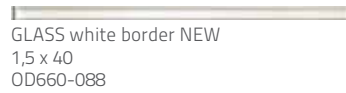

GLASS white border NEW
1,5 x 40
OD660-088

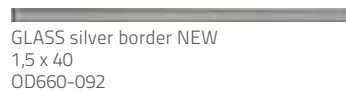

GLASS silver border NEW
1,5 x 40
OD660-092

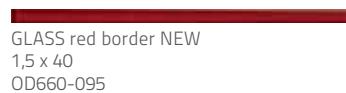

GLASS red border NEW
1,5 x 40
OD660-095

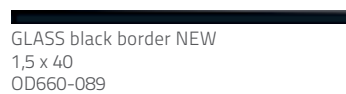

GLASS black border NEW
1,5 x 40
OD660-089

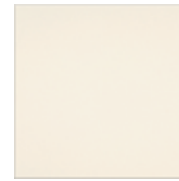

INWENCJA cream
20 x 20
OP044-008-1

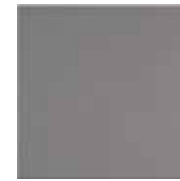

INWENCJA graphite
20 x 20
OP044-002-1

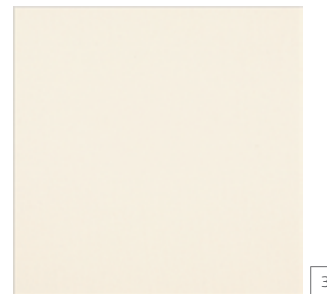

INWENCJA cream
33,3 x 33,3
OP044-016-1



glossy tiles



matt tiles

cm	cm	pcs	m ²	kg	kg/m ²	m ²	cm	cm	pcs
20x20	0,7	25	1	12	12	72	1,5x40 glass	0,8	10
20x20 inserto	0,7	1	-	-	-	-			
33,3x33,3	0,8	12	1,33	23,41	17,6	63,84			

p#
172
173





Crystal Palace

modern

20x20



p#
174
175

Crystal Palace

20x20



CRYSTAL PALACE
white inserto A
20 x 20
OD625-003



CRYSTAL PALACE
grey inserto A
20 x 20
OD625-005



CRYSTAL PALACE
brown inserto A
20 x 20
OD625-001



CRYSTAL PALACE
white inserto B
20 x 20
OD625-004



CRYSTAL PALACE
grey inserto B
20 x 20
OD625-006



CRYSTAL PALACE
brown inserto B
20 x 20
OD625-002



SUNNY WOOD beige
20 x 50
OP615-001-1

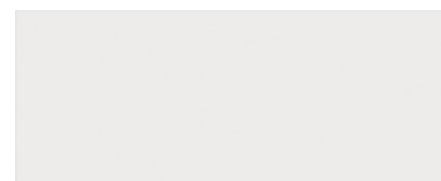











WHITE satin
20 x 50
OP399-001-1



SUNNY WOOD beige
33,3 x 33,3
OP615-004-1

3



 cm	 cm	 pcs	 m ²	 kg	 kg/m ²	 m ²	 cm	 cm	 pcs
20x50	0,9	13	1,3	22,63	17,41	46,80			
20x20 inserto	0,8	1	-	-	-	-			
33,3x33,3	0,8	12	1,33	23,41	17,60	63,84			

p#
176
177





Cuban Cube

modern

20x20

p#
178
179



Cuban Cube

20x20



CUBAN CUBE red
20 x 20
OD626-001



CUBAN CUBE yellow
20 x 20
OD626-002



CUBAN CUBE light blue
20 x 20
OD626-003



CUBAN CUBE green
20 x 20
OD626-004



CUBAN CUBE graphite
20 x 20
OD626-005



CUBAN CUBE blue
20 x 20
OD626-006

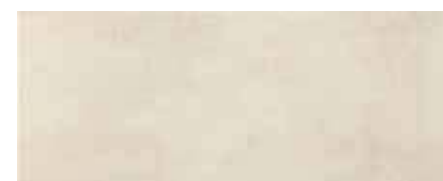

CEMENTO grey
20 x 50
OP398-001-1

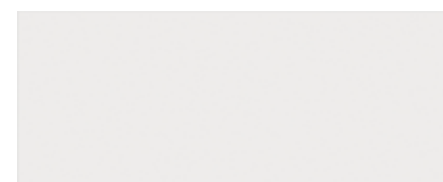

WHITE satin
20 x 50
OP399-001-1



CEMENTO grey
33,3 x 33,3
OP398-004-1

3

glossy tiles

20x50	0,9	13	1,3	22,63	17,41	46,80			
20x20 inserto	0,8	1	-	-	-	-			
33,3x33,3	0,8	12	1,33	23,41	17,60	63,84			

p#
180
181



Inwencja

modern

20x20





INWENCJA white
20 x 20
OP044-001-1

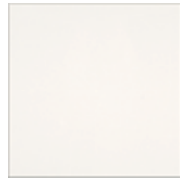

INWENCJA white glossy
20 x 20
OP044-007-1

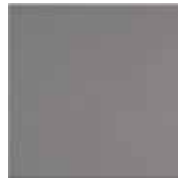

INWENCJA graphite
20 x 20
OP044-002-1



INWENCJA red
20 x 20
OP044-003-1



INWENCJA grey
20 x 20
OP044-014-1



INWENCJA white mosaic
20 x 20
OD044-024



INWENCJA white mosaic glossy
20 x 20
OD044-025

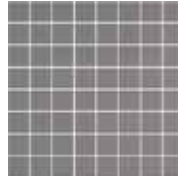

INWENCJA graphite mosaic
20 x 20
OD044-033

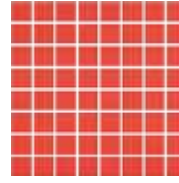

INWENCJA red mosaic
20 x 20
OD044-034



INWENCJA grey mosaic
20 x 20
OD044-032

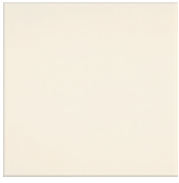

INWENCJA cream
20 x 20
OP044-008-1

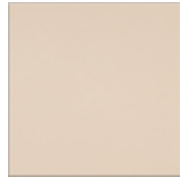

INWENCJA beige
20 x 20
OP044-009-1

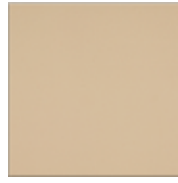

INWENCJA mocca
20 x 20
OP044-010-1



INWENCJA magnolia
20 x 20
OP044-011-1

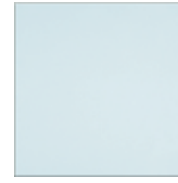

INWENCJA blue
20 x 20
OP044-013-1



INWENCJA cream mosaic
20 x 20
OD044-026

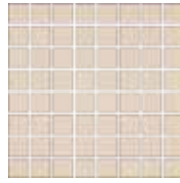

INWENCJA beige mosaic
20 x 20
OD044-027

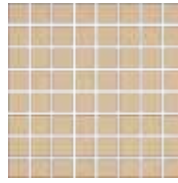

INWENCJA mocca mosaic
20 x 20
OD044-028

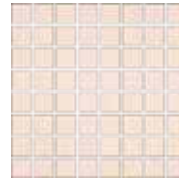

INWENCJA magnolia mosaic
20 x 20
OD044-029

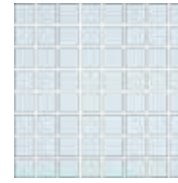

INWENCJA blue mosaic
20 x 20
OD044-031

p#
182
183



INWENCJA yellow
20 x 20
OP044-004-1



INWENCJA sapphire
20 x 20
OP044-006-1



INWENCJA malachite
20 x 20
OP044-005-1



INWENCJA pistachio
20 x 20
OP044-012-1

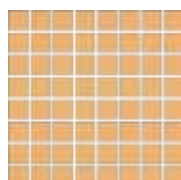

INWENCJA yellow mosaic
20 x 20
OD044-035

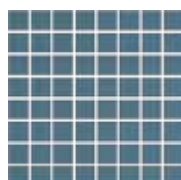

INWENCJA sapphire mosaic
20 x 20
OD044-037

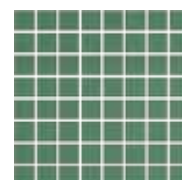

INWENCJA malachite mosaic
20 x 20
OD044-036

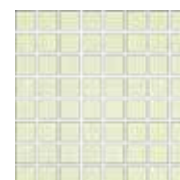

INWENCJA pistachio mosaic
20 x 20
OD044-030



INWENCJA white
10 x 10
OP044-020-1



INWENCJA cream
10 x 10
OP044-022-1



INWENCJA beige
10 x 10
OP044-023-1



INWENCJA graphite
10 x 10
OP044-021-1

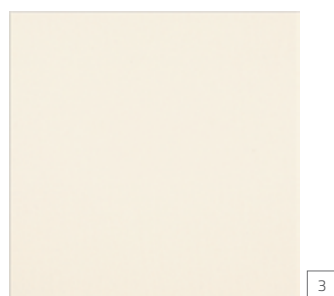

INWENCJA cream
33,3 x 33,3
OP044-016-1

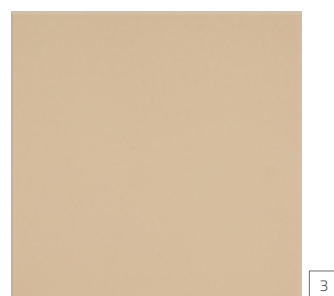

INWENCJA mocca
33,3 x 33,3
OP044-017-1

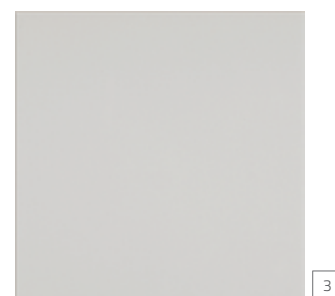

INWENCJA grey
33,3 x 33,3
OP044-019-1



cm	cm	pcs	m ²	kg	kg/m ²	m ²	cm	cm	pcs
20x20	0,7	25	1	12,0	12,0	72			
20x20 mosaic	0,7	26	-	-	-	-			
10x10	0,65	52	0,5	5,67	11,33	60			
33,3x33,3	0,8	12	1,33	23,41	17,60	63,84			

p#
184
185

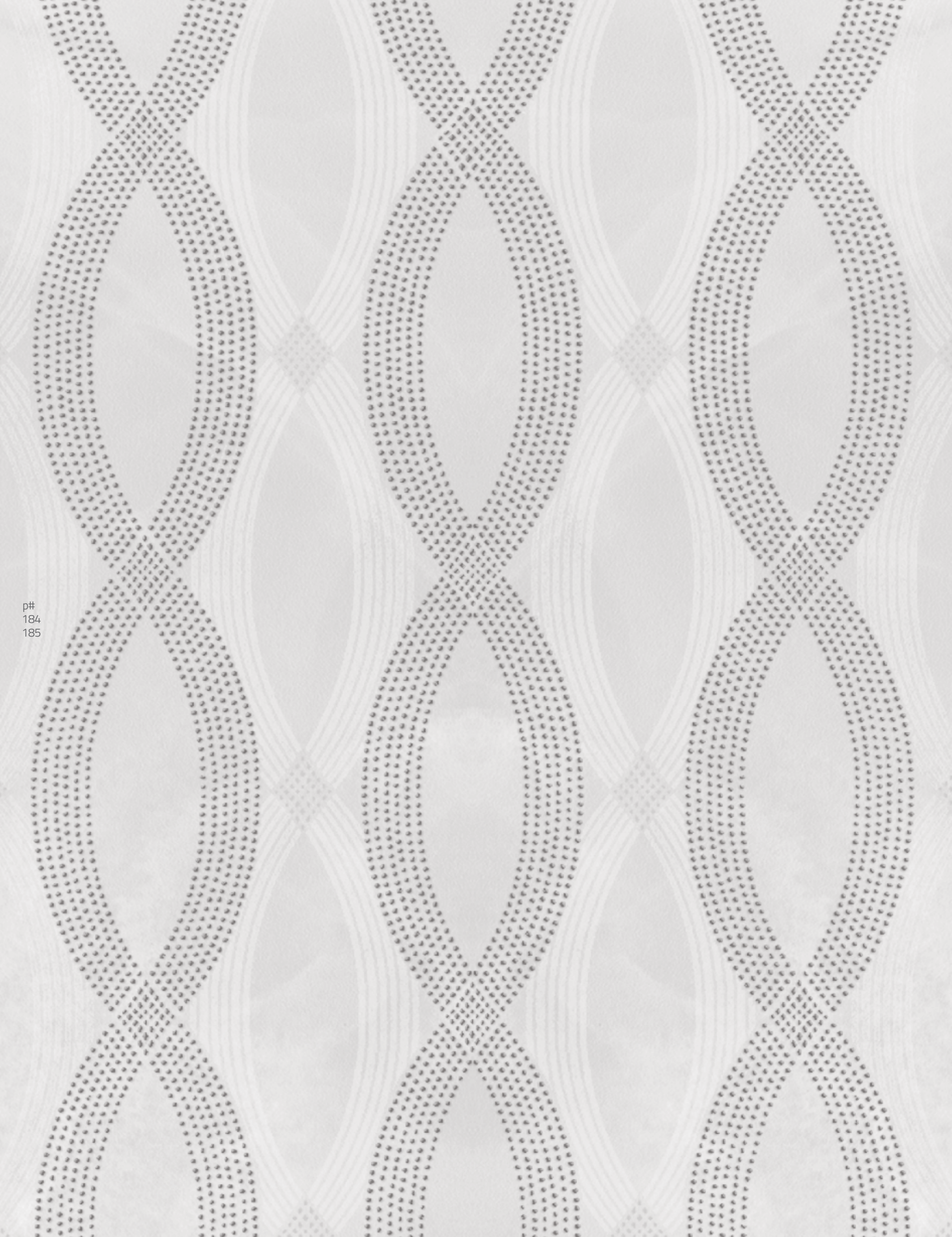

Łazienka

Bathroom

classic

p#
186
187



new

Arkos
classic

45x90





R10

4

ARKOS cream lappato
44,6 x 89,5
MT005-001-1



R10

4

ARKOS cream lappato
44,6 x 44,6
MT005-002-1



4

ARKOS cream mosaic
22,2 x 44,6
MD005-008



4

ARKOS cream mosaic classic
22,2 x 44,6
MD005-006



4

ARKOS cream classic border
9,8 x 44,6
MD005-010



4

ARKOS cream corner classic
9,8 x 9,8
MD005-012

p#
188
189

new

Arkos
45x90



ARKOS brown lappato
44,6 x 44,6
MT005-004-1



ARKOS brown lappato
44,6 x 89,5
MT005-003-1

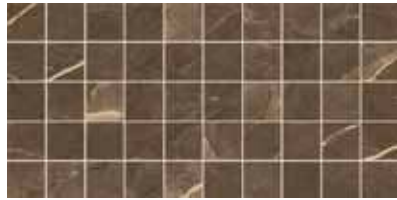

ARKOS brown mosaic
22,2 x 44,6
MD005-007



ARKOS brown mosaic classic
22,2 x 44,6
MD005-005



ARKOS brown classic border
9,8 x 44,6
MD005-009



ARKOS brown corner classic
9,8 x 9,8
MD005-011



cm	cm	pcs	m ²	kg	kg/m ²	m ²	cm	cm	pcs
44,6x89,5	1,1	3	1,2	29,76	24,8	21,6	9,8x44,6	1,1	8
44,6x44,6	1,1	6	1,19	29,51	24,8	23,8	9,8x9,8	1,1	4
22,2x44,6	1,1	8	-	-	-	-			



abrasion-resistance class



non-slip class



frost-resistant tile

p#
190
191



new

Daino
classic

45x90





DAINO cream
44,6 x 89,5
MT001-001-1



DAINO cream
44,6 x 44,6
MT001-002-1



DAINO cream lappato
44,6 x 89,5
MT001-003-1



DAINO cream lappato
44,6 x 44,6
MT001-004-1



DAINO cream structure
44,6 x 89,5
MT001-010-1



DAINO cream mosaic
22,2 x 44,6
MD001-017



DAINO beige mosaic classic
22,2 x 44,6
MD001-016



DAINO cream border flower
1,9 x 89,5
MD001-011



DAINO cream border flower
4,9 x 89,5
MD001-012



DAINO cream border classic
7,2 x 44,6
MD001-014



DAINO cream corner classic
7,2 x 7,2
MD001-015

p#
192
193

new

Daíno
45x90



DAINO beige
44,6 x 44,6
MT001-007-1



DAINO beige
44,6 x 89,5
MT001-005-1



DAINO beige lappato
44,6 x 44,6
MT001-008-1



DAINO beige lappato
44,6 x 89,5
MT001-006-1



DAINO beige mosaic
22,2 x 44,6
MD001-018



DAINO beige structure
44,6 x 89,5
MT001-009-1



DAINO beige border glass
3,9 x 89,5
MD001-013



cm	cm	pcs	m ²	kg	kg/m ²	m ²	cm	cm	pcs
44,6x89,5	1,1	3	1,2	29,76	24,8	21,6	1,9x89,5	1,1	10
44,6x44,6	1,1	6	1,19	29,5	24,8	23,8	4,9x89,5	1,1	10
44,6x89,5 inserto	1,1	3	1,2	29,76	24,8	21,6	7,2x44,6	1,1	10
22,2x44,6 mosaic	1,1	8	-	-	-	-	7,2x7,2	1,1	4
							3,9x89,5	1,1	16



p#
194
195

new

Yakara
classic

45x90



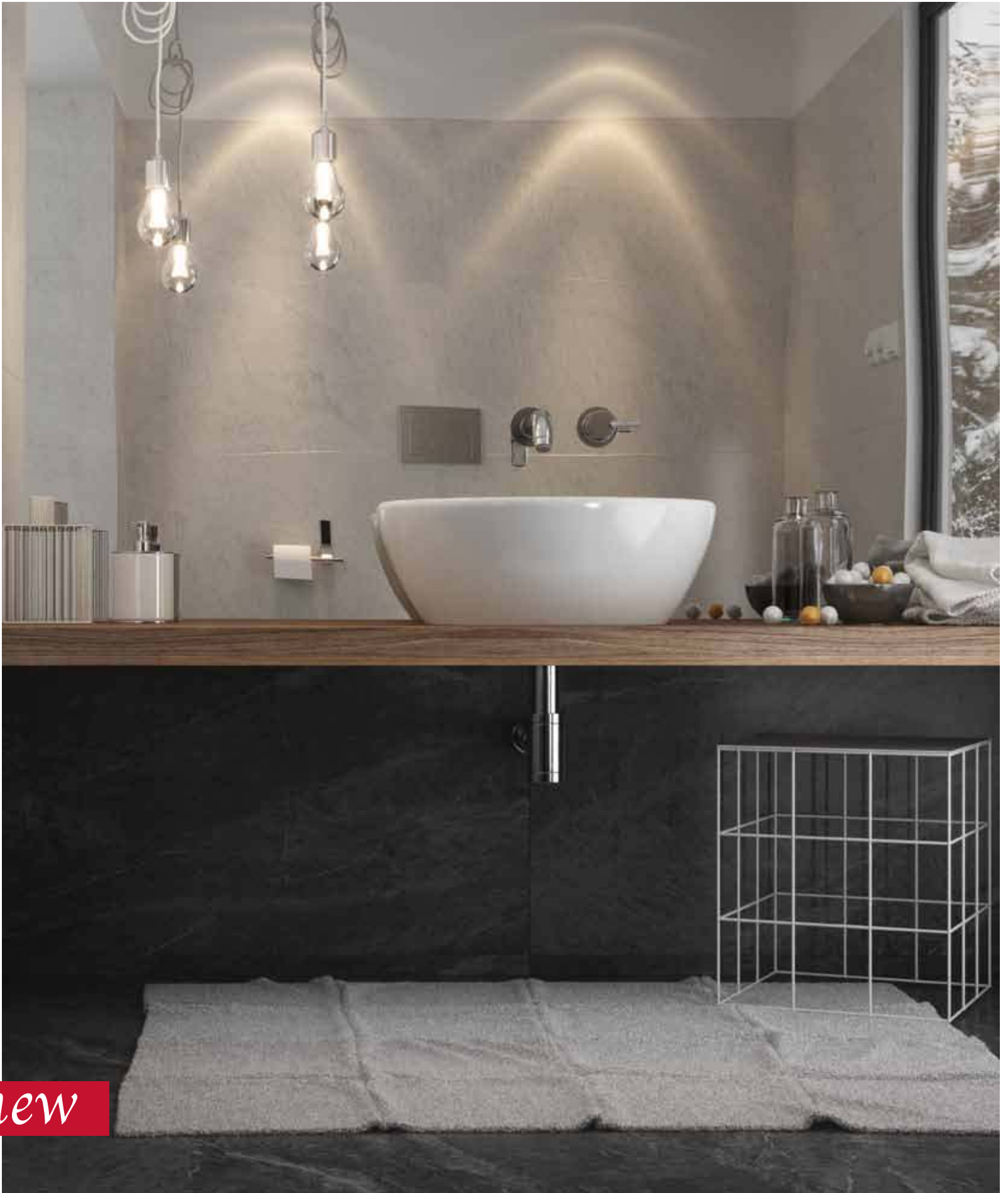

p#
196
197

new

Yakara
45x90



✳️
R10
5

YAKARA white
44,6 x 44,6
MT002-010-1



✳️
R10
5

YAKARA white
44,6 x 89,5
MT002-007-1



✳️
R9
4

YAKARA white lappato
44,6 x 44,6
MT002-001-1



✳️
R9
4

YAKARA white lappato
44,6 x 89,5
MT002-004-1



YAKARA white mosaic steel
22,2 x 44,6
MD002-019



✳️
4

YAKARA white mosaic
22,2 x 44,6
MD002-014



YAKARA white inserto line lappato
44,6 x 89,5
MD002-021



GLASS red border
2,3 x 89,5
MD002-020



STELL border
2,3 x 89,5
MD002-013



YAKARA grey
44,6 x 89,5
MT002-008-1



YAKARA grey
44,6 x 44,6
MT002-011-1



YAKARA grey lappato
44,6 x 89,5
MT002-005-1



YAKARA grey lappato
44,6 x 44,6
MT002-002-1



YAKARA grey inserto line lappato
44,6 x 89,5
MD002-022

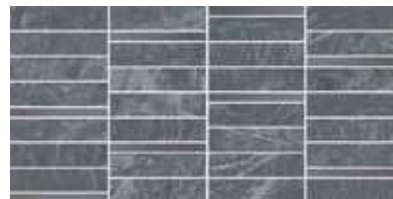

YAKARA grey mosaic steel
22,2 x 44,6
MD002-018



YAKARA grey mosaic
22,2 x 44,6
MD002-015

new

Yakara

45x90



YAKARA graphite
44,6 x 44,6
MT002-012-1



YAKARA graphite
44,6 x 89,5
MT002-009-1



YAKARA graphite lappato
44,6 x 44,6
MT002-003-1



YAKARA graphite lappato
44,6 x 89,5
MT002-006-1



YAKARA graphite mosaic steel
22,2 x 44,6
MD002-017



YAKARA graphite inserto line lappato
44,6 x 89,5
MD002-023



YAKARA graphite mosaic
22,2 x 44,6
MD002-016



cm	cm	pcs	m ²	kg	kg/m ²	m ²	cm	cm	pcs
44,6x89,5	1,1	3	1,2	29,76	24,8	21,6	2,3x89,5 glass	1,1	5
44,6x44,6	1,1	6	1,19	29,5	24,8	23,8	2,3x89,5 glass	1,1	20
44,6x89,5 inserto	1,1	2	-	-	-	-			
22,2x44,6 mosaic	1,1	8	-	-	-	-			

p#
200
201

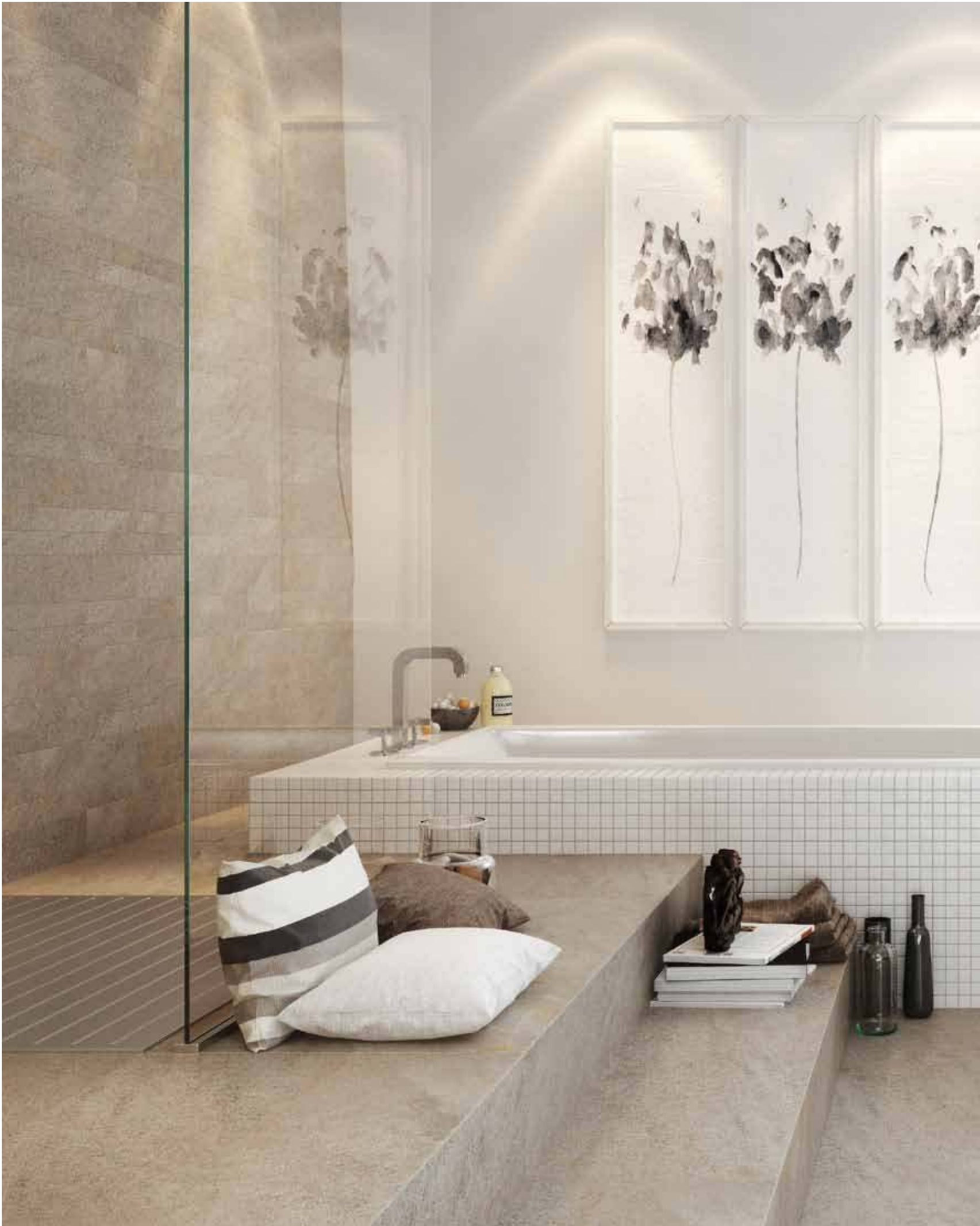

new

Quartz
classic

45x90



p#
202
203

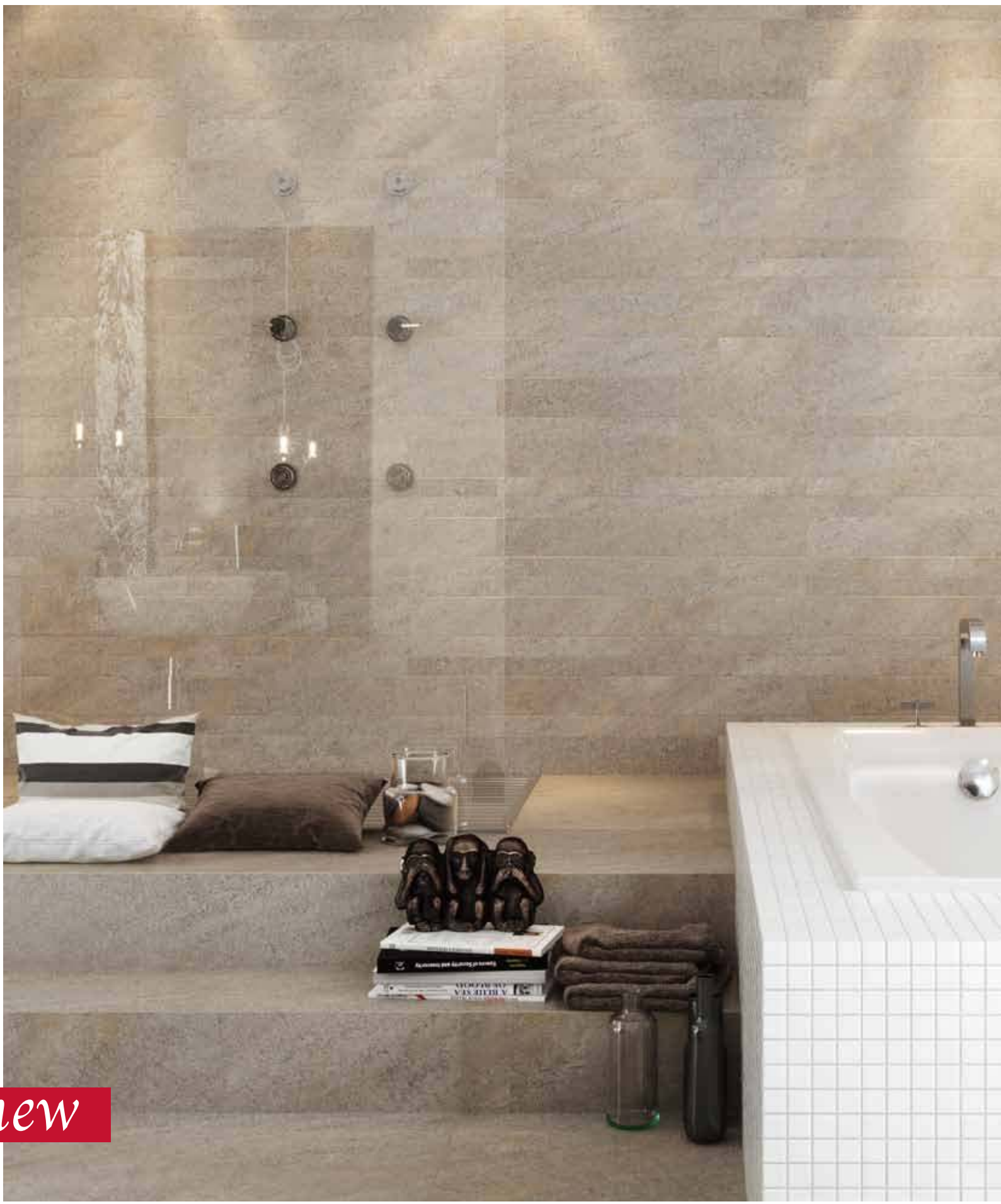

new

Quartz
45x90



QUARTZ beige
44,6 x 89,5
MT006-001-1













QUARTZ beige mosaic A
22,2 x 44,6
MD006-003



QUARTZ beige mosaic B
22,2 x 44,6
MD006-004

 matt tiles  rectified tiles

 cm	 cm	 pcs	 m ²	 kg	 kg/m ²	 m ²	 cm	 cm	 pcs
44,6x89,5	1,1	3	1,2	29,76	24,8	21,6			
22,2x44,6 mosaic	1,1	8	-	-	-	-			

p#
204
205

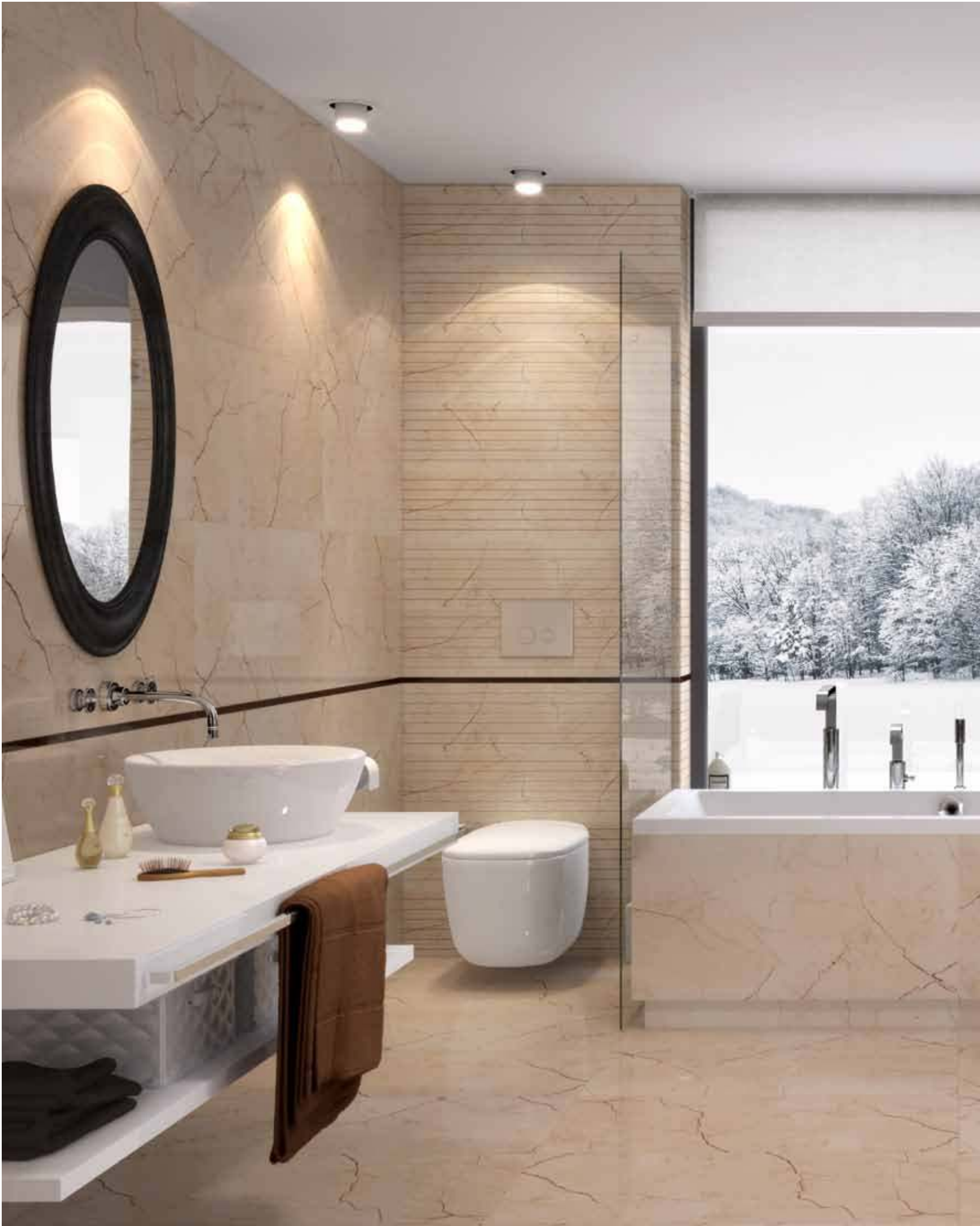

new

Playa
classic

45x90



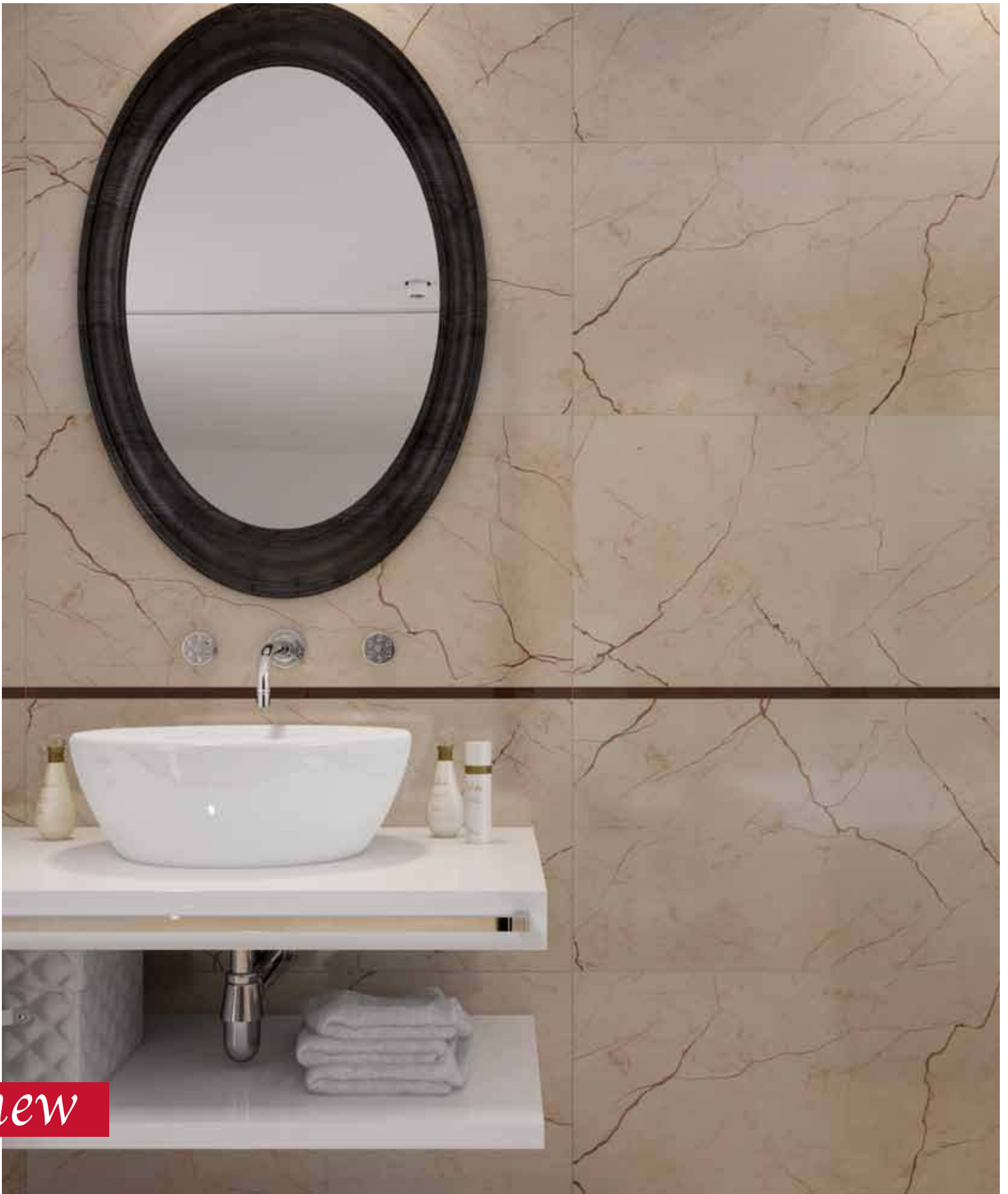

p#
206
207

new

Playa
45x90



PLAYA cream lappato
44,6 x 89,5
MT003-001-1



PLAYA cream lappato
44,6 x 44,6
MT003-002-2



PLAYA cream border line
22,2 x 89,5
MD003-007

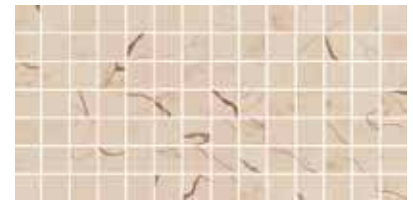

PLAYA cream mosaic
22,2 x 44,6
MD003-003



PLAYA cream border
9,4 x 44,6
MD003-008



PLAYA cream border
9,4 x 9,4
MD003-006



PLAYA cream mosaic glass
22,2 x 44,6
MD003-004



GLASS amber border
3 x 89,5
MD003-005



GLASS brown border
3 x 89,5
MD004-006



glossy tiles



rectified tiles

cm	cm	pcs	m ²	kg	kg/m ²	m ²	cm	cm	pcs
44,6x89,5	1,1	3	1,2	29,76	24,8	21,6	9,4x44,6	1,1	8
44,6x44,6	1,1	6	1,19	29,5	24,8	23,8	9,4x9,4	1,1	4
22,2x89,5	1,1	4	-	-	-	-	3x89,5	1,1	5
22,2x44,6 mosaic	1,1	8	-	-	-	-			



abrasion-resistance class



non-slip class



frost-resistant tile

p#
208
209





Carrara
classic

60x60

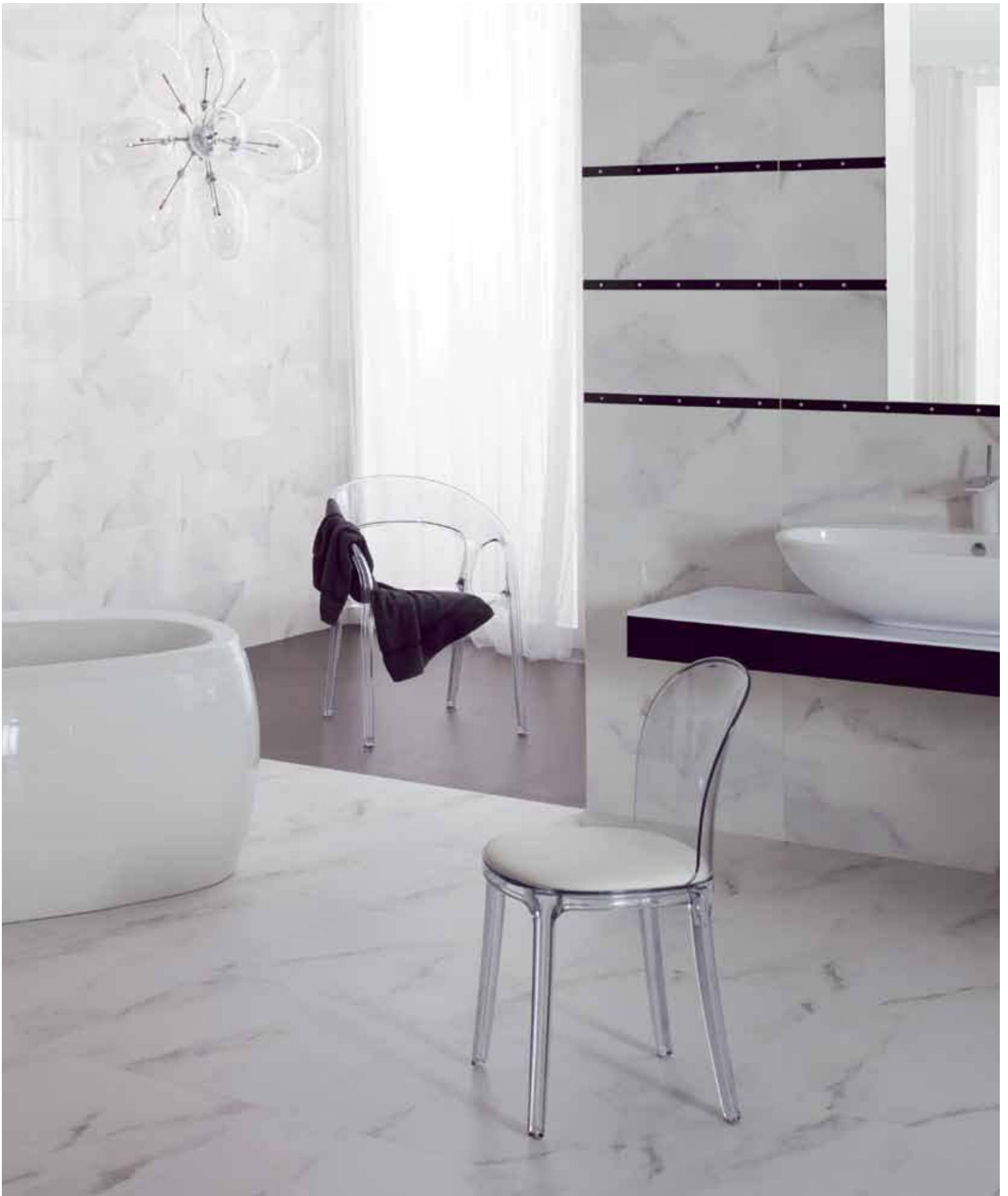

p#
210
211

Carrara
60x60

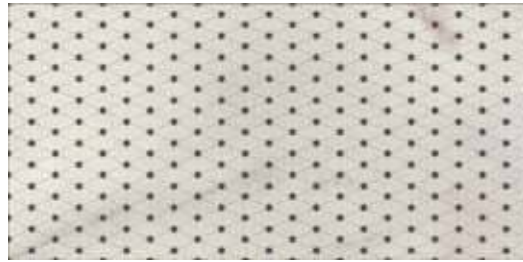

CARRARA inserto classic
29 x 59,3
OD001-004



CARRARA
29 x 59,3
OP001-003-1



CARRARA white mosaic
29 x 29,5
OD001-009



CARRARA inserto stripe
29 x 59,3
OD001-005



GLASS red border NEW
2 x 59,3
OD660-047



CARRARA border
3 x 59,3
OD001-007



CARRARA
59,3 x 59,3
OP001-001-1



CARRARA polished
59,3 x 59,3
OP001-002-1



glossy tiles



rectified tiles

cm	cm	pcs	m ²	kg	kg/m ²	m ²	cm	cm	pcs
29x59,3	0,9	7	1,2	22,8	19,0	38,4	3x59,3	1	12
29x59,3 inserto classic	0,9	4	-	-	-	-	2x59,3 glass	1	21
29x29,5 mosaic	0,9	11	-	-	-	-			
59,3x59,3	1	5	1,76	42,5	24,15	35,2			



3

abrasion-resistance class



frost-resistant tile

p#
212
213

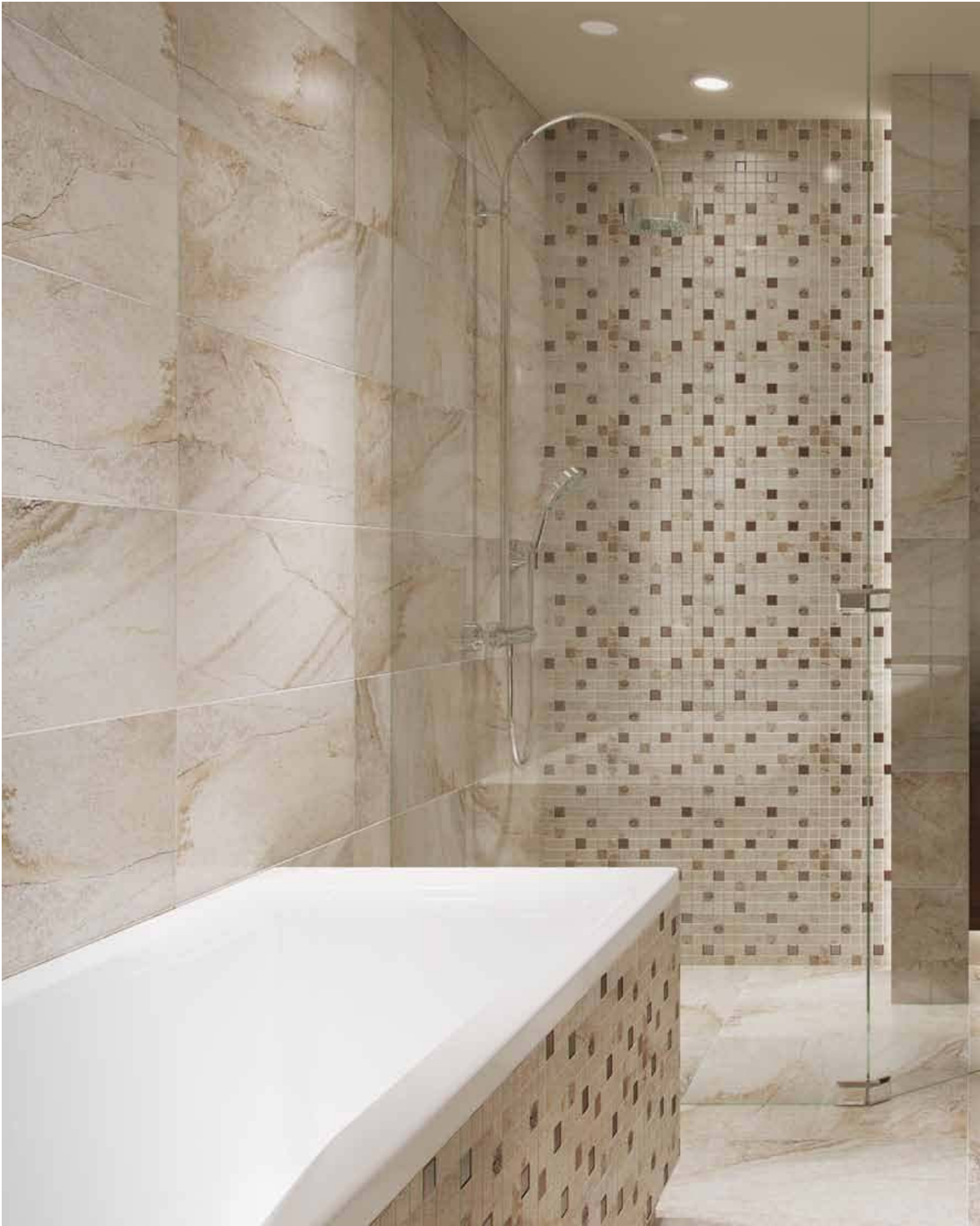



Sahara
classic

60x60

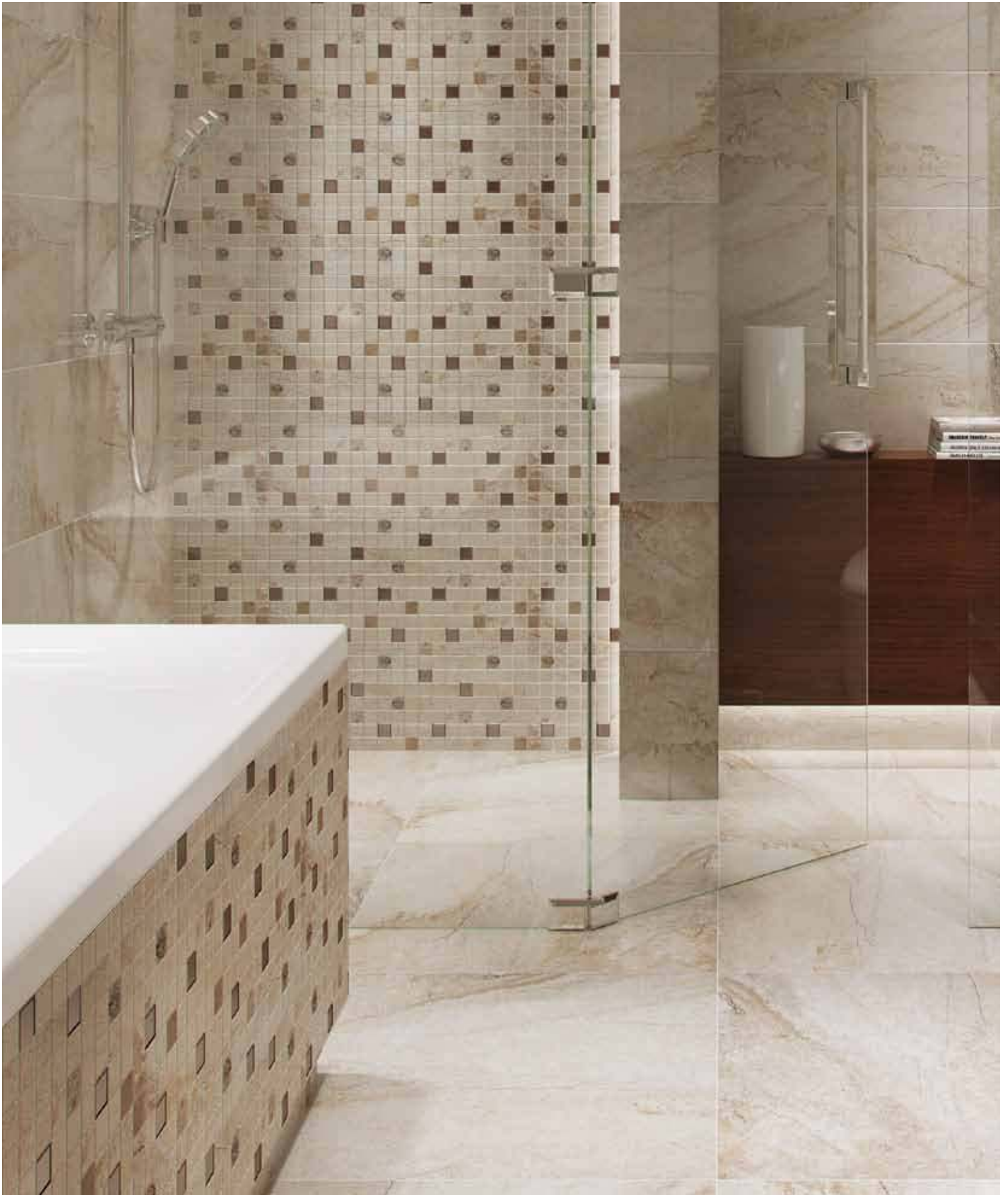

p#
214
215

Sahara
60x60



SAHARA beige lappato
29 x 59,3
OP358-002-1



SAHARA beige border
8,7 x 59,3
OD358-005



GLASS brown border
2,7 x 59,3
OD358-003



GLASS beige border NEW
2 x 59,3
OD660-042



GLASS orange border NEW
2 x 59,3
OD660-032



SAHARA beige lappato
59,3 x 59,3
OP358-001-1













SAHARA beige border mosaic
11,7 x 29,5
OD358-004



glossy tiles



rectified tiles

 cm	 cm	 pcs	 m ²	 kg	 kg/m ²	 m ²	 cm	 cm	 pcs
59,3x59,3	1	5	1,76	41,5	23,58	35,20	8,7x59,3	1	10
29x59,3	1	7	1,2	28,00	23,33	38,40	2,7x59,3	1	14
11,7x29,5 mosaic	1	8	-	-	-	-	2x59,3 glass	1	21



abrasion-resistance class



non-slip class



frost-resistant tile

p#
216
217



Lazio
classic

30x60



LAZIO beige
29 x 59,3
OP004-005-1



LAZIO white
29 x 59,3
OP004-006-1



LAZIO white mosaic
29 x 29,5
OD004-016



LAZIO beige inserto
29 x 59,3
OD004-007

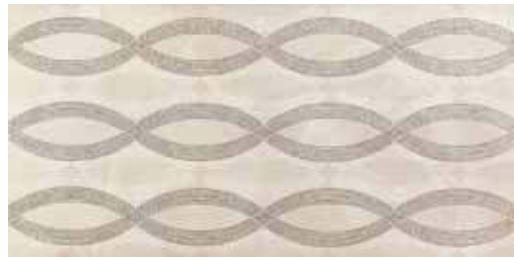

LAZIO white inserto
29 x 59,3
OD004-008



LAZIO beige mosaic
29 x 29,5
OD004-015



LAZIO beige border
9 x 59,3
OD004-011



LAZIO white border
9 x 59,3
OD004-010

p#
218
219



LAZIO border
2,8 x 59,3
OD004-014



GLASS white border NEW
2 x 59,3
OD660-040

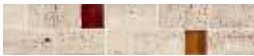

LAZIO border
5,8 x 29
OD004-013



GLASS red border NEW
2 x 59,3
OD660-047



GLASS orange border NEW
2 x 59,3
OD660-032



GLASS brown border NEW
2 x 59,3
OD660-043

Lazio
30x60



LAZIO white
59,3 x 59,3
OP004-003-1



LAZIO white polished
59,3 x 59,3
OP004-004-1



LAZIO beige
59,3 x 59,3
OP004-001-1













LAZIO beige polished
59,3 x 59,3
OP004-002-1



glossy tiles



rectified tiles

 cm	 cm	 pcs	 m ²	 kg	 kg/m ²	 m ²	 cm	 cm	 pcs
29x59,3	0,9	7	1,2	22.80	19	38,4	9x59,3	0,9	10
29x59,3 inserto	0,9	4	-	-	-	-	2,8x59,3	1	30
29x29,5 mosaic	0,9	11	-	-	-	-	2x59,3 glass	1	21
59,3x59,3	1	5	1,76	42.50	24.15	35,2	5,8x29	1	10

p#
220
221





Naturale
classic

30x60



NATURALE cream
29,7 x 59,8
OP012-009-1



NATURALE beige
29,7 x 59,8
OP012-003-1



NATURALE cream
14,8 x 59,8
OP012-007-1



NATURALE beige
14,8 x 59,8
OP012-001-1



NATURALE orange
29,7 x 59,8
OP012-012-1



NATURALE brown
29,7 x 59,8
OP012-006-1



NATURALE orange
14,8 x 59,8
OP012-010-1



NATURALE brown
14,8 x 59,8
OP012-004-1



NATURALE silver border classic
14,8 x 59,8
OD012-020



NATURALE gold border classic
14,8 x 59,8
OD012-018



GLASS beige border NEW
2 x 59,3
OD660-042



GLASS brown border NEW
2 x 59,3
OD660-043

p#
222
223

Naturale

30x60



NATURALE orange mosaic
29,7 x 29,7
OD012-023



NATURALE brown mosaic
29,7 x 29,7
OD012-022



NATURALE cream
29,7 x 29,7
OP012-008-1



NATURALE beige
29,7 x 29,7
OP012-002-1



NATURALE orange
29,7 x 29,7
OP012-011-1



NATURALE brown
29,7 x 29,7
OP012-005-1



NATURALE beige border mosaic
5,4 x 29,7
OD012-015



matt tiles



structured tiles

cm	cm	pcs	m ²	kg	kg/m ²	m ²	cm	cm	pcs
29,7x59,8	0,85	9	1,6	30,5	19,06	51,2	14,8x59,8	0,85	10
14,8x59,8	0,85	10	0,89	16,87	19,06	31,86	5,4x29,7	0,8	5
29,7x29,7 mosaic	0,8	15	-	-	-	-	2x59,3 glass	1	21
29,7x29,7	0,8	15	1,32	22,15	16,78	58,08			

4

3

abrasion-resistance class

R9

non-slip class



frost-resistant tile



p#
224
225

Salonika
classic

30x60



SALONIKA cream inserto
29 x 59,3
OD006-004



SALONIKA cream
29 x 59,3
OP006-003-1



SALONIKA beige
29 x 59,3
OP006-002-1



SALONIKA cream border classic
9,8 x 59,3
OD006-007



SALONIKA cream border classic
6,1 x 59,3
OD006-006



SALONIKA cream border classic
9,8 x 29
OD006-009



SALONIKA cream corner classic
9,8 x 9,8
OD006-011



SALONIKA cream border classic
6,1 x 29
OD006-008



SALONIKA cream corner classic
6,1 x 6,1
OD006-010



SALONIKA beige
29 x 29
OP006-001-1



3



glossy tiles



rectified tiles

cm	cm	pcs	m ²	kg	kg/m ²	m ²	cm	cm	pcs
29x59,3	0,9	7	1,2	22,8	19	38,4	9,8x59,3	1,1	10
29x59,3 inserto	0,9	4	-	-	-	-	9,8x29	1,1	10
29x29	0,8	15	1,26	21,67	17,2	55,44	6,1x59,3	1,1	10
							6,1x29	1,1	20
							9,8x9,8	1,1	20
							6,1x6,1	1,1	20

3 abrasion-resistance class

frost-resistant tile

p#
226
227





Organza
classic

20x50



ORGANZA white
20 x 50
OP017-007-1



ORGANZA cream
20 x 50
OP017-009-1



GLASS beige border NEW
2 x 50
OD660-058



GLASS orange border NEW
2 x 50
OD660-048



GLASS red border NEW
2 x 50
OD660-063



GLASS brown border NEW
2 x 50
OD660-059

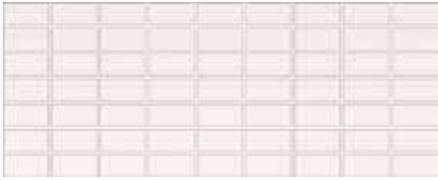

ORGANZA white mosaic
20 x 50
OD017-022

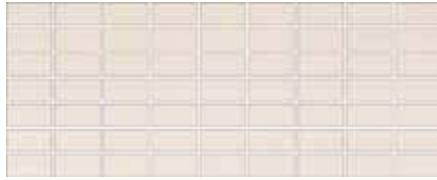

ORGANZA cream mosaic
20 x 50
OD017-024



ORGANZA mosaic mix B
20 x 50
OD017-026



ORGANZA mosaic mix A
20 x 50
OD017-025

p#
228
229



ORGANZA white
29,7 x 29,7
OP017-002-1



ORGANZA cream
29,7 x 29,7
OP017-004-1



GLASS white border NEW
2 x 50
OD660-056



GLASS silver border NEW
2 x 50
OD660-060



GLASS heather border NEW
2 x 50
OD660-062



GLASS azure border NEW
2 x 50
OD660-052



ORGANZA grey
20 x 50
OP017-011-1



ORGANZA brown
20 x 50
OP017-008-1

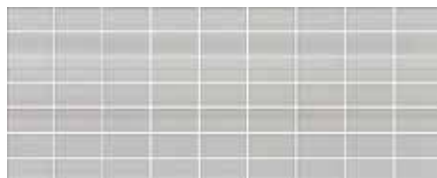

ORGANZA grey mosaic
20 x 50
OD017-027



ORGANZA brown mosaic
20 x 50
OD017-023



ORGANZA grey inserto flower
20 x 50
OD017-017



ORGANZA brown inserto flower
20 x 50
OD017-015



ORGANZA grey
29,7 x 29,7
OP017-005-1



2



ORGANZA brown
29,7 x 29,7
OP017-003-1



2



cm	cm	pcs	m ²	kg	kg/m ²	m ²	cm	cm	pcs
20x50	0,9	13	1,3	22,63	17,41	46,8	2x50 glass	0,8	10
20x50 inserto	0,9	10	-	-	-	-			
20x50 mosaic	0,9	10	-	-	-	-			
29,7x29,7	0,8	15	1,32	22,15	16,78	58,08			

3

2

abrasion-resistance class



frost-resistant tile



p#
230
231



Vanilla Stone
classic

20x50



p#
232
233

Vanilla Stone
20x50



VANILLA STONE beige
20 x 50
OP616-001-1

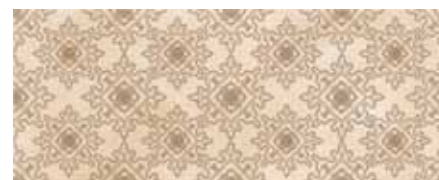

VANILLA STONE beige pattern
20 x 50
OP616-002-1



VANILLA STONE beige inserto classic
20 x 50
OP616-003-1



GLASS white border NEW
2 x 50
OD660-056



GLASS black border NEW
2 x 50
OD660-057













GLASS brown border NEW
2 x 50
OD660-059



VANILLA STONE beige
33,3 x 33,3
OP616-004-1

3

 glossy tiles

 cm	 cm	 pcs	 m ²	 kg	 kg/m ²	 m ²	 cm	 cm	 pcs
20x50	0,90	13	1,3	22,63	17,41	46,80	2x50 glass	0,8	10
20x50 inserto	0,90	10	-	-	-	-			
33,3x33,3	0,80	12	1,33	23,41	17,60	63,84			

 abrasion-resistance class



p#
234
235

Kuchnia

Kitchen

modern



p#
236
237



BE STRONG
WHEN YOU ARE WEAK
BE BRAVE
WHEN YOU ARE SCARED
BE HUMBLE
WHEN YOU ARE
VICTORIOUS

MAKE **ART** YOUR LIFE

Be what you want to be **NOT** what others want to be

YOU
were born **WINNER**
DON'T LOSE

City Call
modern

30x60

BE STRONG
WHEN YOU ARE WEAK
BE BRAVE
WHEN YOU ARE SCARED
BE HUMBLE
WHEN YOU ARE
VICTORIOUS

MAKE **ART** YOUR LIFE

Be what you want to be **NOT** what others want to be



p#
238
239

City Call
30x60

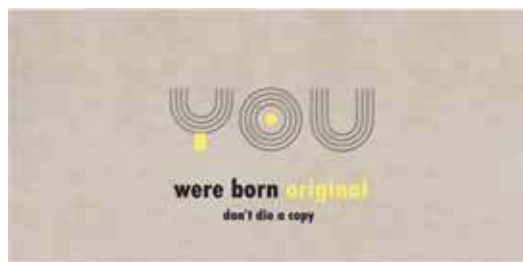

CITY CALL you inserto
29,7 x 59,8
OD623-001



CITY CALL brave inserto
29,7 x 59,8
OD623-002



CITY CALL not inserto
29,7 x 59,8
OD623-003



CITY CALL art inserto
29,7 x 59,8
OD623-004



DAMASCO vanilla
29,7 x 29,7
OP067-005-1



DAMASCO vanilla
29,7 x 59,8
OP067-018-1



DAMASCO vanilla
59,8 x 59,8
OP067-028-1



new



GLASS beige border NEW
2 x 60
OD660-027



GLASS yellow border NEW
2 x 60
OD660-018



GLASS orange border NEW
2 x 60
OD660-017



GLASS red border NEW
2 x 60
OD660-031



GLASS black border NEW
2 x 60
OD660-026



cm	cm	pcs	m ²	kg	kg/m ²	m ²	cm	cm	pcs
59,8x59,8	1	5	1,79	24,15	43,23	35,80	2x60 glass	1	21
29,7x59,8	0,85	9	1,6	22,15	19,06	51,20			
29,7x59,8 inserto	0,85	9	-	-	-	-			
29,7x29,7	0,8	15	1,32	22,14	17,17	58,08			



abrasion-resistance class



non-slip class



frost-resistant tile



p#
240
241



French Touch

modern

30x60

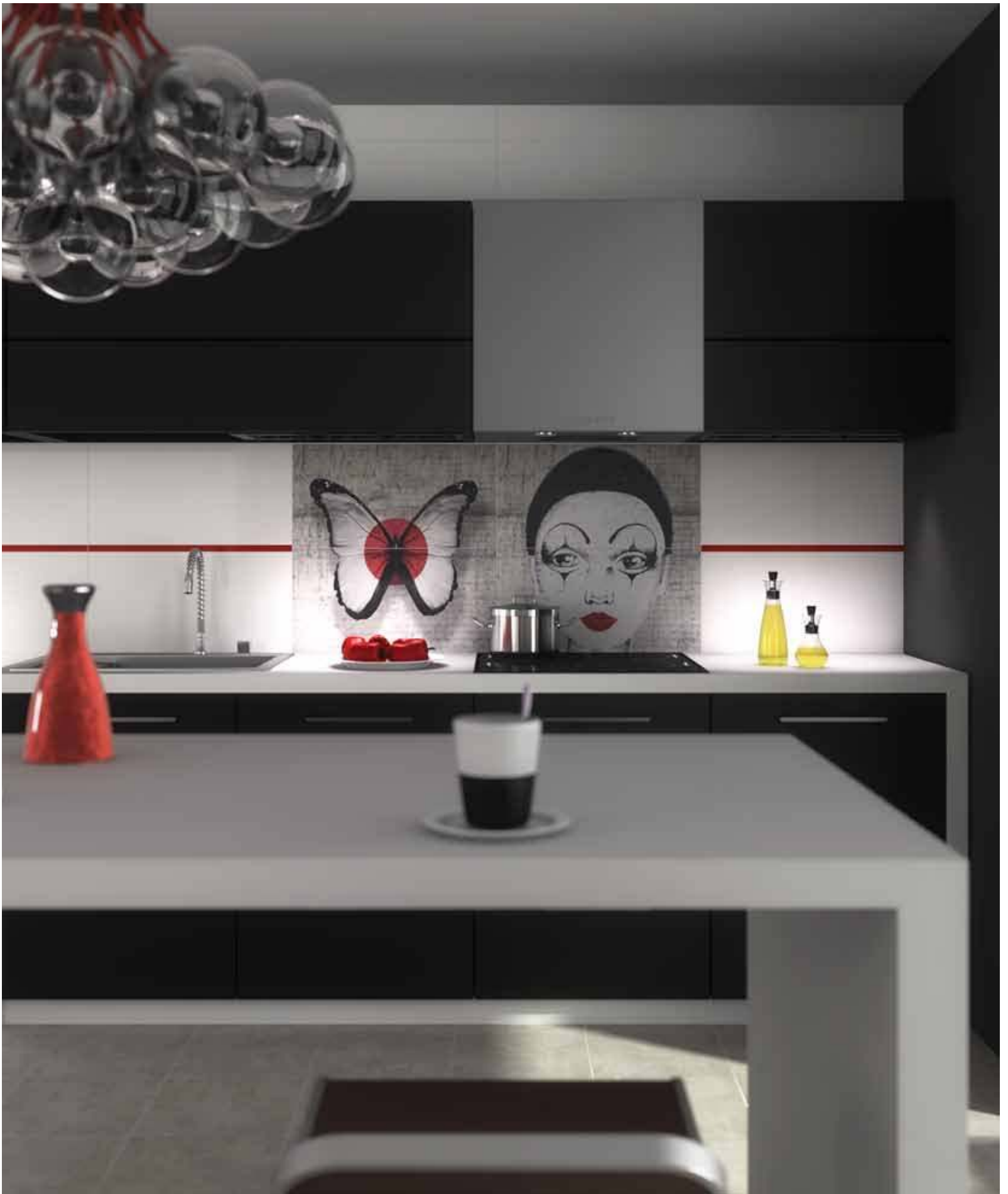

p#
242
243

French Touch

30x60



FRENCH TOUCH butterfly inserto
58,3 x 59,3
OP630-002



FRENCH TOUCH pierrot inserto
58,3 x 59,3
OP630-003

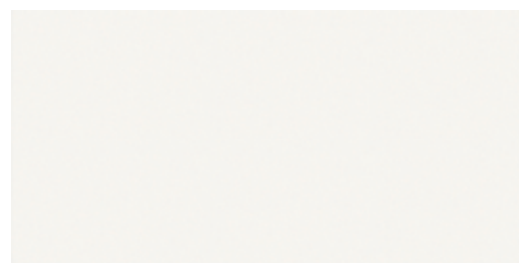

WHITE SATIN
29 x 59,3
OP630-001-1



GLASS red border NEW
2 x 59,3
OD660-047



GLASS silver border NEW
2 x 59,3
OD660-044



GLASS brown border NEW
2 x 59,3
OD660-043



FARGO grey
32,6 x 32,6
OP360-011-1



rectified tiles



matt tiles

cm	cm	pcs	m ²	kg	kg/m ²	m ²	cm	cm	pcs
29x59,3	0,9	7	1,2	22,8	19,0	38,4	2x59,3	1	21
58,3x59,3 inserto	0,9	2 sets	-	-	-	-			
32,6x32,6	0,8	12	1,17	21,11	18,04	56,16			

4

abrasion-resistance class

R9

non-slip class



frost-resistant tile

p#
244
245





Italian Fresco

modern

30x60



p#
246
247

Italian Fresco

30x60



ITALIAN FRESCO cream inserto
29,7 x 59,8
OD624-001



ITALIAN FRESCO brown inserto
29,7 x 59,8
OD624-002



ITALIAN FRESCO graphite inserto
29,7 x 59,8
OD624-003



GLASS red border NEW
4,8 x 60
OD660-016



GLASS yellow border NEW
4,8 x 60
OD660-002



GLASS brown border NEW
4,8 x 60
OD660-012

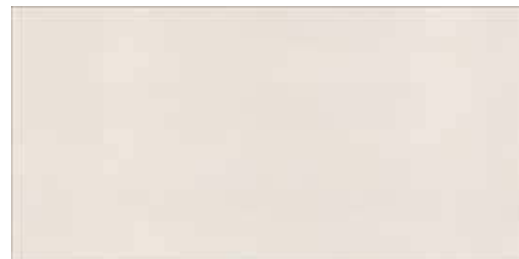

AMARANTE cream
29,7 x 59,8
OP009-005-1

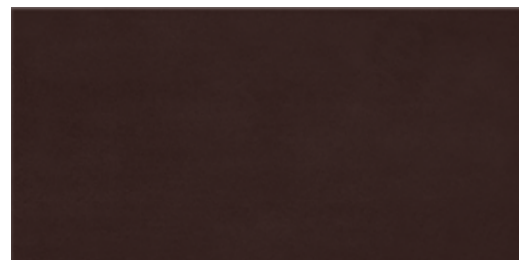

AMARANTE brown
29,7 x 59,8
OP009-001-1



AMARANTE graphite
29,7 x 59,8
OP009-003-1



GLASS white border NEW
4,8 x 60
OD660-009



GLASS silver border NEW
4,8 x 60
OD660-013



GLASS black border NEW
4,8 x 60
OD660-010



matt
tiles



structured
tiles

cm	cm	pcs	m ²	kg	kg/m ²	m ²	cm	cm	pcs
29,7x59,8	0,85	9	1,6	30,5	19,06	51,20	4,8x60 glass	1	7
29,7x59,8 inserto	0,85	9	-	-	-	-			

p#
248
249

Penne

modern

20x50



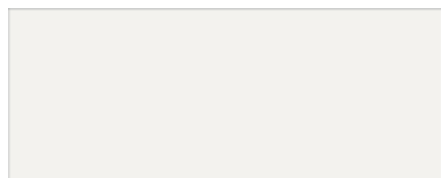

WHITE glossy
20 x 50
OP018-001-1



PENNE inserto modern 2
20 x 50
OD018-009



PENNE inserto modern 1
20 x 50
OD018-008

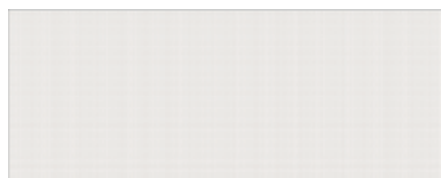

PENNE white
20 x 50
OP018-002-1



PENNE inserto coffee 2
20 x 50
OD018-006



PENNE inserto coffee 1
20 x 50
OD018-005



GLASS white border NEW
2 x 50
OD660-056



PENNE violet inserto
20 x 50
OD018-011



PENNE blue inserto
20 x 50
OD018-010



GLASS silver border NEW
2 x 50
OD660-060



PENNE violet profile
2 x 50
OD018-015



PENNE blue profile
2 x 50
OD018-014



GLASS red border NEW
2 x 50
OD660-063



GLASS heather border NEW
2 x 50
OD660-062



PENNE inserto flower
20 x 50
OD018-007

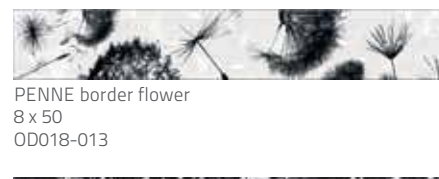

PENNE border flower
2,5 x 50
OD018-012



GLASS violet border NEW
2 x 50
OD660-054



GLASS azure border NEW
2 x 50
OD660-052



GLASS cobalt border NEW
2 x 50
OD660-053

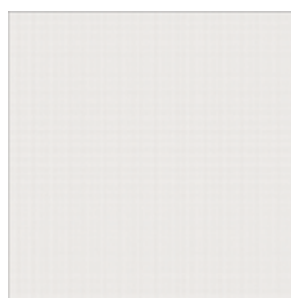

PENNE white
33,3 x 33,3
OP018-003-1



PENNE grey
33,3 x 33,3
OP018-004-1



cm	cm	pcs	m ²	kg	kg/m ²	m ²	cm	cm	pcs
20x50	1	13	1,3	22,63	17,41	46,8	8x50	1	6
20x50 inserto	1	10	-	-	-	-	2,5x50	1	18
33,3x33,3	0,8	12	1,33	23,41	17,6	63,84	2x50	1,2	8
							2x50 glass	0,8	10



p#
250
251



Cuban Cube

modern

20x20



p#
252
253

Cuban Cube

20x20



CUBAN CUBE red
20 x 20
OD626-001



CUBAN CUBE yellow
20 x 20
OD626-002



CUBAN CUBE light blue
20 x 20
OD626-003



CUBAN CUBE green
20 x 20
OD626-004



CUBAN CUBE graphite
20 x 20
OD626-005



CUBAN CUBE blue
20 x 20
OD626-006



CEMENTO grey
20 x 50
OP398-001-1

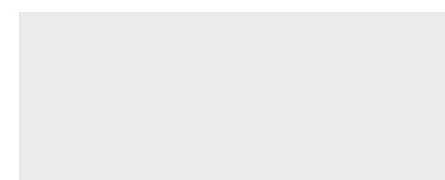

WHITE satin
20 x 50
OP399-001-1



CEMENTO grey
33,3 x 33,3
OP398-004-1

3



cm	cm	pcs	m ²	kg	kg/m ²	m ²	cm	cm	pcs
20x50	0,9	13	1,3	22,63	17,41	46,80			
20x20 inserto	0,8	1	-	-	-	-			
33,3x33,3	0,8	12	1,33	23,41	17,60	63,84			



p#
254
255



Crystal Palace
modern

20x20



p#
256
257

Crystal Palace

20x20



CRYSTAL PALACE
white inserto A
20 x 20
OD625-003



CRYSTAL PALACE
grey inserto A
20 x 20
OD625-005



CRYSTAL PALACE
brown inserto A
20 x 20
OD625-001



CRYSTAL PALACE
white inserto B
20 x 20
OD625-004



CRYSTAL PALACE
grey inserto B
20 x 20
OD625-006



CRYSTAL PALACE
brown inserto B
20 x 20
OD625-002



SUNNY WOOD beige
20 x 50
OP615-001-1

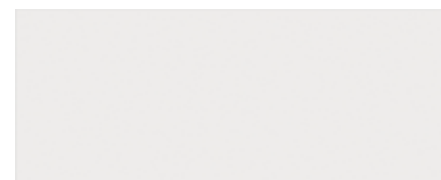











WHITE satin
20 x 50
OP399-001-1



SUNNY WOOD beige
33,3 x 33,3
OP615-004-1

3



 cm	 cm	 pcs	 m ²	 kg	 kg/m ²	 m ²	 cm	 cm	 pcs
20x50	0,9	13	1,3	22,63	17,41	46,80			
20x20 inserto	0,8	1	-	-	-	-			
33,3x33,3	0,8	12	1,33	23,41	17,60	63,84			



p#
258
259



Colour Connection

modern

20x20



p#
260
261

Colour Connection

20x20



COLOUR CONNECTION
black-cream inserto A
20 x 20
OD627-003



COLOUR CONNECTION
red-cream inserto A
20 x 20
OD627-007



COLOUR CONNECTION
grey-red inserto A
20 x 20
OD627-005



COLOUR CONNECTION
grey-black inserto A
20 x 20
OD627-001

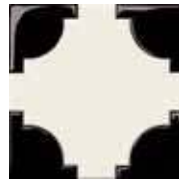

COLOUR CONNECTION
black-cream inserto B
20 x 20
OD627-004



COLOUR CONNECTION
red-cream inserto B
20 x 20
OD627-008



COLOUR CONNECTION
grey-red inserto B
20 x 20
OD627-006



COLOUR CONNECTION
grey-black inserto B
20 x 20
OD627-002



GLASS white border NEW
1,5 x 40
OD660-088



GLASS silver border NEW
1,5 x 40
OD660-092



GLASS red border NEW
1,5 x 40
OD660-095



GLASS black border NEW
1,5 x 40
OD660-089

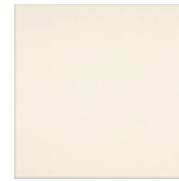

INWENCJA cream
20 x 20
OP044-008-1

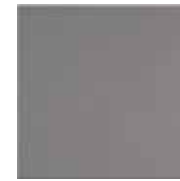

INWENCJA graphite
20 x 20
OP044-002-1

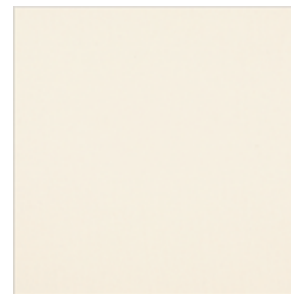

INWENCJA cream
33,3 x 33,3
OP044-016-1

3



glossy tiles



matt tiles

cm	cm	pcs	m ²	kg	kg/m ²	m ²	cm	cm	pcs
20x20	0,7	25	1	12	12	72	1,5x40 glass	0,8	10
20x20 inserto	0,7	1	-	-	-	-			
33,3x33,3	0,8	12	1,33	23,41	17,6	63,84			

p#
262
263





Inwencja
modern

20x20 / 10x10



INWENCJA white
20 x 20
OP044-001-1



INWENCJA white glossy
20 x 20
OP044-007-1

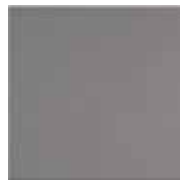

INWENCJA graphite
20 x 20
OP044-002-1



INWENCJA red
20 x 20
OP044-003-1



INWENCJA grey
20 x 20
OP044-014-1



INWENCJA white mosaic
20 x 20
OD044-024

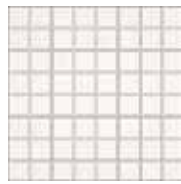

INWENCJA white mosaic glossy
20 x 20
OD044-025

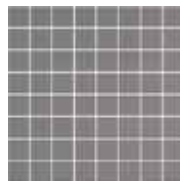

INWENCJA graphite mosaic
20 x 20
OD044-033

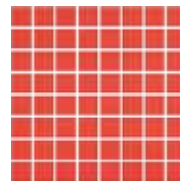

INWENCJA red mosaic
20 x 20
OD044-034



INWENCJA grey mosaic
20 x 20
OD044-032

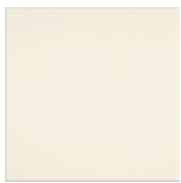

INWENCJA cream
20 x 20
OP044-008-1

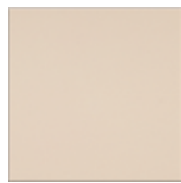

INWENCJA beige
20 x 20
OP044-009-1

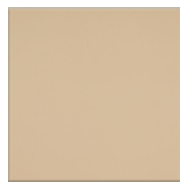

INWENCJA mocca
20 x 20
OP044-010-1

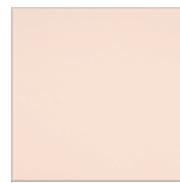

INWENCJA magnolia
20 x 20
OP044-011-1

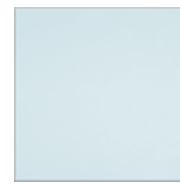

INWENCJA blue
20 x 20
OP044-013-1



INWENCJA cream mosaic
20 x 20
OD044-026

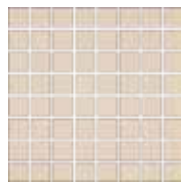

INWENCJA beige mosaic
20 x 20
OD044-027

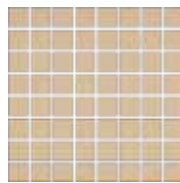

INWENCJA mocca mosaic
20 x 20
OD044-028

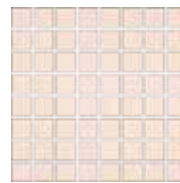

INWENCJA magnolia mosaic
20 x 20
OD044-029

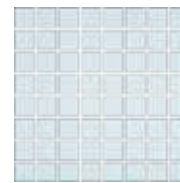

INWENCJA blue mosaic
20 x 20
OD044-031



INWENCJA yellow
20 x 20
OP044-004-1



INWENCJA sapphire
20 x 20
OP044-006-1



INWENCJA malachite
20 x 20
OP044-005-1



INWENCJA pistachio
20 x 20
OP044-012-1

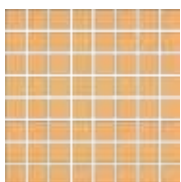

INWENCJA yellow mosaic
20 x 20
OD044-035

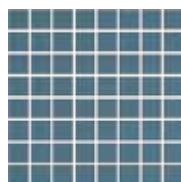

INWENCJA sapphire mosaic
20 x 20
OD044-037

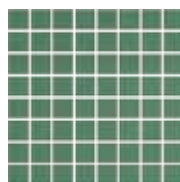

INWENCJA malachite mosaic
20 x 20
OD044-036

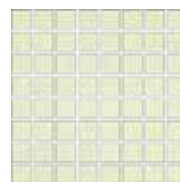

INWENCJA pistachio mosaic
20 x 20
OD044-030

p#
264
265

Inwencja

20x20x/10x10



INWENCJA inserto kiwi
10 x 10
OD044-042



INWENCJA inserto lemon
10 x 10
OD044-043



INWENCJA inserto orange
10 x 10
OD044-045



INWENCJA inserto melon
10 x 10
OD044-044



INWENCJA inserto coffee 1
10 x 10
OD044-038



INWENCJA inserto coffee 2
10 x 10
OD044-039



INWENCJA inserto coffee 3
10 x 10
OD044-040



INWENCJA inserto coffee 4
10 x 10
OD044-041



INWENCJA white
10 x 10
OP044-020-1



INWENCJA cream
10 x 10
OP044-022-1



INWENCJA beige
10 x 10
OP044-023-1



INWENCJA graphite
10 x 10
OP044-021-1

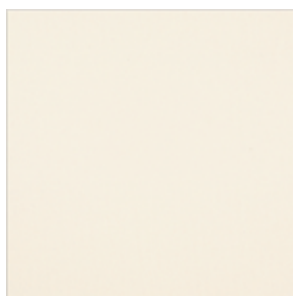

INWENCJA cream
33,3 x 33,3
OP044-016-1



INWENCJA mocca
33,3 x 33,3
OP044-017-1

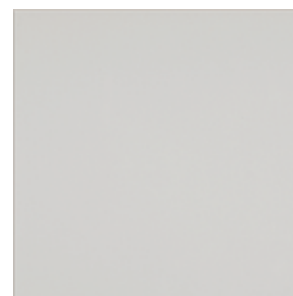

INWENCJA grey
33,3 x 33,3
OP044-019-1



cm	cm	pcs	m ²	kg	kg/m ²	m ²	cm	cm	pcs
20x20	0,7	25	1	12	12	72			
20x20 mosaic	0,7	26	-	-	-	-			
10x10	0,65	52	0,5	5,67	11,33	60			
10x10 inserto	0,65	4	-	-	-	-			
33,3x33,3	0,8	12	1,33	23,41	17,6	63,84			



p#
266
267

Aplauz
modern

10x10



APLAUZ white
10 x 10
OP046-001-1



APLAUZ brown
10 x 10
OP046-002-1



APLAUZ red
10 x 10
OP046-004-1



APLAUZ black
10 x 10
OP046-003-1



APLAUZ red
inserto flower 1
10 x 10
OD046-014



APLAUZ white
inserto ornament
10 x 10
OD046-005



APLAUZ brown
inserto ornament
10 x 10
OD046-006



APLAUZ red
inserto ornament
10 x 10
OD046-009



APLAUZ black
inserto ornament
10 x 10
OD046-008



APLAUZ red
inserto flower 2
10 x 10
OD046-015



APLAUZ white
inserto espresso
10 x 10
OD046-011



APLAUZ brown
inserto espresso
10 x 10
OD046-012



APLAUZ red
inserto espresso
10 x 10
OD046-013



APLAUZ black
inserto espresso
10 x 10
OD046-010



APLAUZ grey
inserto flower 1
10 x 10
OD046-016



APLAUZ white
inserto tea
10 x 10
OD046-021



APLAUZ brown
inserto tea
10 x 10
OD046-022



APLAUZ red
inserto tea
10 x 10
OD046-024



APLAUZ black
inserto tea
10 x 10
OD046-023



APLAUZ grey
inserto flower 2
10 x 10
OD046-017



APLAUZ inserto cafe
10 x 10
OD046-007



APLAUZ inserto
milk
10 x 10
OD046-019



APLAUZ inserto
green tea
10 x 10
OD046-018



APLAUZ white
inserto belt
10 x 10
OD046-020



BAZALTO graphite
39,6 x 39,6
OP059-004-1



3



BAZALTO cream
39,6 x 39,6
OP059-001-1



4



glossy
tiles

cm	cm	pcs	m ²	kg	kg/m ²	m ²	cm	cm	pcs
10x10	0,65	52	0,5	5,67	11,33	60			
10x10 inserto	0,65	4	-	-	-	-			
39,6x39,6	0,85	9	1,41	24,10	17,09	36,66			

4 3

abrasion-resistance class



frost-resistant tile

p#
268
269

Montana

modern

10x10





MONTANA white
10 x 10
OP046-001-1



MONTANA orange
10 x 10
OP140-002-1



MONTANA green
10 x 10
OP140-004-1



MONTANA grey
10 x 10
OP140-003-1



MONTANA graphite
10 x 10
OP140-001-1



MONTANA inserto choco
10 x 10
OD140-005



MONTANA inserto juice
10 x 10
OD140-009



MONTANA inserto tea
10 x 10
OD140-011



MONTANA inserto water
10 x 10
OD140-012



MONTANA inserto England
10 x 10
OD140-006



MONTANA inserto France
10 x 10
OD140-007



MONTANA inserto Italia
10 x 10
OD140-008



MONTANA inserto Poland
10 x 10
OD140-010



BAZALTO cream
39,6 x 39,6
OP059-001-1



4



BAZALTO graphite
39,6 x 39,6
OP059-004-1



3



glossy tiles

cm	cm	pcs	m ²	kg	kg/m ²	m ²	cm	cm	pcs
10x10	0,65	52	0,5	5,67	11,33	60			
10x10 inserto	0,65	4	-	-	-	-			
39,6x39,6	0,85	9	1,41	24,10	17,09	36,66			

4 3

abrasion-resistance class



frost-resistant tile



Salisa
modern

10x10



p#
270
271



SALISA cream
10 x 10
OP053-004-1



SALISA red
10 x 10
OP053-002-1



SALISA brown
10 x 10
OP053-001-1



SALISA graphite
10 x 10
OP053-003-1



SALISA cream
inserto
10 x 10
OD053-008



SALISA red
inserto
10 x 10
OD053-006



SALISA brown
inserto
10 x 10
OD053-005





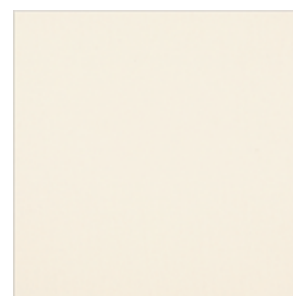







SALISA graphite
inserto
10 x 10
OD053-007



3

INWENCJA cream
33,3 x 33,3
OP044-016-1



 cm	 cm	 pcs	 m ²	 kg	 kg/m ²	 m ²	 cm	 cm	 pcs
10x10	0,65	52	0,5	5,67	11,33	60			
10x10 inserto	0,65	4	-	-	-	-			
33,3x33,3	0,8	12	1,33	23,41	17,60	63,84			



p#
272
273

Kuchnia

Kitchen

classic

p#
274
275



new

Quartz
classic

45x90





p#
276
277

new

Quartz
45x90



QUARTZ beige
44,6 x 89,5
MT006-001-1



QUARTZ beige mosaic A
22,2 x 44,6
MD006-003













QUARTZ beige mosaic B
22,2 x 44,6
MD006-004



QUARTZ beige steptread
29,5 x 44,6
MT006-006

 matt tiles  rectified tiles

 cm	 cm	 pcs	 m ²	 kg	 kg/m ²	 m ²	 cm	 cm	 pcs
44,6x89,5	1,1	3	1,2	29,76	24,8	21,6			
22,2x44,6 mosaic	1,1	8	-	-	-	-			
29,5 x 44,6 steptread	1,1	6	-	-	-	-			



p#
278
279



Organza
classic

20x50



ORGANZA white
20 x 50
OP017-007-1



ORGANZA cream
20 x 50
OP017-009-1



GLASS beige border NEW
2 x 50
OD660-058



GLASS orange border NEW
2 x 50
OD660-048



GLASS red border NEW
2 x 50
OD660-063



GLASS brown border NEW
2 x 50
OD660-059

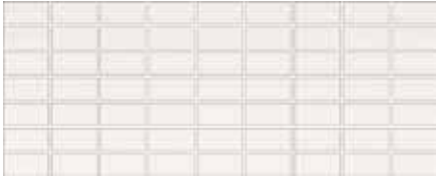

ORGANZA white mosaic
20 x 50
OD017-022

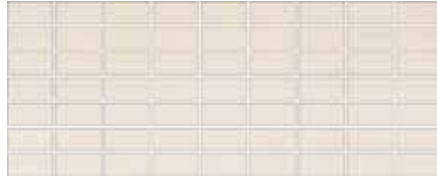

ORGANZA cream mosaic
20 x 50
OD017-024



ORGANZA mosaic mix B
20 x 50
OD017-026



ORGANZA mosaic mix A
20 x 50
OD017-025

p#
280
281



ORGANZA white
29,7 x 29,7
OP017-002-1



ORGANZA cream
29,7 x 29,7
OP017-004-1



GLASS white border NEW
2 x 50
OD660-056



GLASS silver border NEW
2 x 50
OD660-060



GLASS heather border NEW
2 x 50
OD660-062



GLASS azure border NEW
2 x 50
OD660-052



ORGANZA grey
20 x 50
OP017-011-1



ORGANZA brown
20 x 50
OP017-008-1

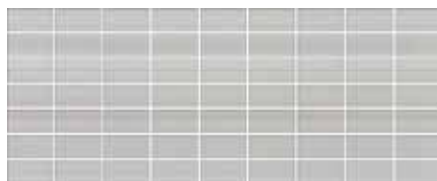

ORGANZA grey mosaic
20 x 50
OD017-027

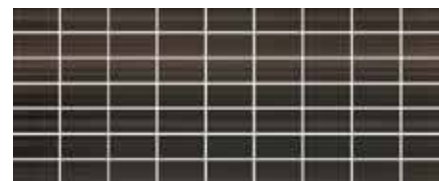

ORGANZA brown mosaic
20 x 50
OD017-023



ORGANZA grey inserto flower
20 x 50
OD017-017



ORGANZA brown inserto flower
20 x 50
OD017-015



ORGANZA grey
29,7 x 29,7
OP017-005-1



2



ORGANZA brown
29,7 x 29,7
OP017-003-1



2



matt
tiles

cm	cm	pcs	m ²	kg	kg/m ²	m ²	cm	cm	pcs
20x50	1	13	1,3	22,6	17,41	46,8	20x50 glass	0,8	10
20x50 inserto	1	10	-	-	-	-			
20x50 mosaic	1	10	-	-	-	-			
29,7x29,7	0,8	15	1,32	22,15	16,78	58,08			

3

2

abrasion-resistance class



frost-resistant tile



p#
282
283



Field Blue
classic

20x20



p#
284
285

Field Blue
20x20

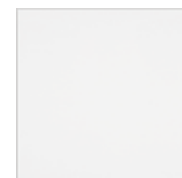

INWENCJA white glossy
20 x 20
OP044-007-1



GLASS white border NEW
1,5 x 40
OD660-088



GLASS yellow border NEW
1,5 x 40
OD660-081



GLASS black border NEW
1,5 x 40
OD660-089



GLASS cobalt border NEW
1,5 x 40
OD660-085



FIELD BLUE inserto A
20 x 20
OD628-001



FIELD BLUE inserto B
20 x 20
OD628-002



FIELD BLUE inserto C
20 x 20
OD628-003



FIELD BLUE inserto D
20 x 20
OD628-004

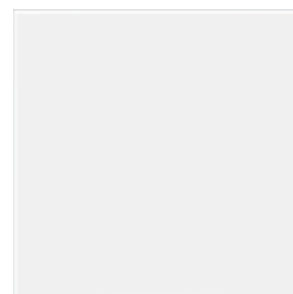

WHITE satin
33,3 x 33,3
OP399-007-1

3



cm	cm	pcs	m ²	kg	kg/m ²	m ²	cm	cm	pcs
20x20	0,7	25	1	12,0	12,0	72	1,5x40 glass	0,8	10
20x20 inserto	0,7	1	-	-	-	-			
33,3x33,3	0,8	12	1,33	23,41	17,60	63,84			



p#
286
287

Morning Fog
classic

20x20

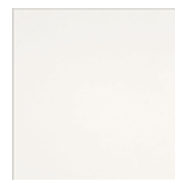

INWENCJA white
20 x 20
OP044-001-1



INWENCJA grey
20 x 20
OP044-014-1

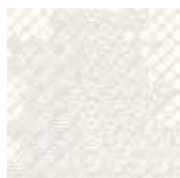

MORNING FOG white inserto A
20 x 20
OD629-001

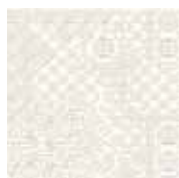

MORNING FOG white inserto B
20 x 20
OD629-002



MORNING FOG white inserto C
20 x 20
OD629-003

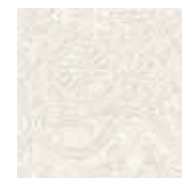

MORNING FOG white
inserto D 20 x 20
OD629-004



MORNING FOG grey inserto A
20 x 20
OD629-005



MORNING FOG grey inserto B
20 x 20
OD629-006



MORNING FOG grey inserto C
20 x 20
OD629-007



MORNING FOG grey
inserto D 20 x 20
OD629-008

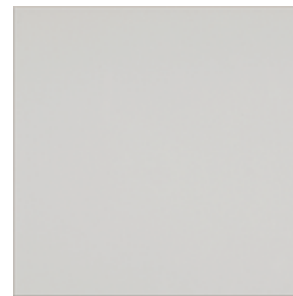







INWENCJA grey
33,3 x 33,3
OP044-019-1

3



matt
tiles

 cm	 cm	 pcs	 m ²	 kg	 kg/m ²	 m ²	 cm	 cm	 pcs
20x20	0,7	25	1	12,00	12,00	72			
20x20 inserto	0,8	10	-	-	-	-			
33,3x33,3	0,8	12	1,33	23,41	17,60	63,84			

p#
288
289

Jesień
classic

10x10





GUSTO
inserto 1
10 x 10
OD048-009



GUSTO
inserto 2
10 x 10
OD048-010



GUSTO
inserto 3
10 x 10
OD048-011



JESIEŃ
beige
10 x 10
OP048-001-1



SKWER
inserto 5
10 x 10
OD048-003



SKWER
inserto 6
10 x 10
OD048-004



JESIEŃ
brown
10 x 10
OP048-002-1



SKWER
inserto 7
10 x 10
OD048-005







SKWER
inserto 8
10 x 10
OD048-006



GUSTO beige composition
20 x 30
OD048-008

 matt
tiles

 cm	 cm	 pcs	 m ²	 kg	 kg/m ²	 m ²	 cm	 cm	 pcs
10x10	0,7	52	0,5	5,67	11,33	60			
10x10 inserto	0,7	4	-	-	-	-			
20x30	0,7	1 (composition)	-	-	-	-			

p#
290
291

Madera
classic

10x10





MADERA sand
10 x 10
OP049-004-1



MADERA amber
10 x 10
OP049-001-1



MADERA beige
10 x 10
OP049-003-1



MADERA
carmine
10 x 10
OP049-002-1



MADERA sand
inserto classic
10 x 10
OD049-009



MADERA sand
border classic left
10 x 10
OD049-010



MADERA sand
border classic
right
10 x 10
OD049-011



MADERA inserto
nature 1
10 x 10
OD049-005



MADERA inserto
nature 2
10 x 10
OD049-006



MADERA inserto
nature 3
10 x 10
OD049-007



MADERA
inserto nature 4
10 x 10
OD049-008



 cm	 cm	 pcs	 m ²	 kg	 kg/m ²	 m ²	 cm	 cm	 pcs
10x10	0,7	52	0,5	5,67	11,33	60			
10x10 inserto	0,7	4	-	-	-	-			

p#
292
293

Sagra
classic

10x10





SAGRA
beige
10 x 10
W 126-048-1



SAGRA
sand
10 x 10
W126-001-1



SAGRA
walnut
10 x 10
W126-002-1



SAGRA
orange
10 x 10
W126-003-1



SAGRA beige composition
coffee
20 x 30
WD126-024



SAGRA sand composition
coffee
20 x 30
WD126-025



SAGRA walnut composition
coffee
20 x 30
WD126-026



SAGRA orange composition
coffee
20 x 30
WD126-027



SAGRA beige composition
coffee 1
10 x 20
WD126-040



SAGRA sand composition
coffee 1
10 x 20
WD126-042



SAGRA walnut composition
coffee 1
10 x 20
WD126-044



SAGRA orange composition
coffee 1
10 x 20
WD126-046



SAGRA beige composition
coffee 2
10 x 20
WD126-041



SAGRA sand composition
coffee 2
10 x 20
WD126-043



SAGRA walnut composition
coffee 2
10 x 20
WD126-045

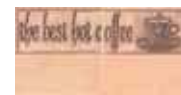

SAGRA orange composition
coffee 2
10 x 20
WD126-047



SAGRA beige
border coffee
5 x 10
WD126-028



SAGRA sand
border coffee
5 x 10
WD126-029



SAGRA walnut
border coffee
5 x 10
WD126-030



SAGRA orange
border coffee
5 x 10
WD126-031



SAGRA beige cigar
3 x 20
WD126-049



SAGRA sand cigar
3 x 20
WD126-050



SAGRA walnut cigar
3 x 20
WD126-051



SAGRA orange cigar
3 x 20
WD126-052



cm	cm	pcs	m ²	kg	kg/m ²	m ²	cm	cm	pcs
10x10	0,7	52	0,5	5,67	11,33	60	3x20	-	18
20x30 composition	0,7	1	-	-	-	-	5x10	0,65	24
10x20 composition	0,7	2	-	-	-	-			



p#
294
295

Salon
Taras

Living room
Terrace

modern

p#
296
297





Dry River

modern

45x90

p#
298
299



Dry River

45x90

new



DRY RIVER cream
44,4 x 89
OP622-039-1



DRY RIVER cream
29,55 x 59,4
OP622-007-1

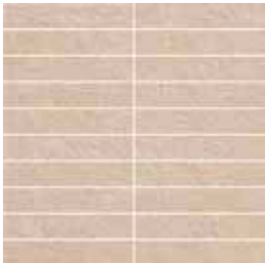

DRY RIVER cream mosaic
29,55 x 29,55
OD622-031



DRY RIVER cream steptread
29,55 x 59,4
OD622-013



DRY RIVER cream
59,4 x 59,4
OP622-001-1



DRY RIVER cream skirting
7,2 x 59,4
OD622-019



new



DRY RIVER beige
44,4 x 89
OP622-037-1



DRY RIVER beige
29,55 x 59,4
OP622-008-1



DRY RIVER beige mosaic
29,55 x 29,55
OD622-032



DRY RIVER beige steptread
29,55 x 59,4
OD622-014



DRY RIVER beige
59,4 x 59,4
OP622-002-1



DRY RIVER beige skirting
7,2 x 29,55
OD622-020





p#
300
301

Dry River

45x90

new



DRY RIVER light grey
44,4 x 89
OP622-042-1



DRY RIVER light grey
29,55 x 59,4
OP622-010-1

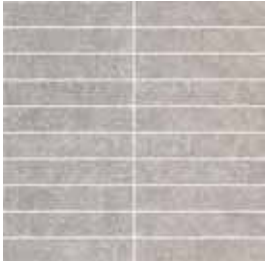

DRY RIVER light grey mosaic
29,55 x 29,55
OD622-034



DRY RIVER light grey steptread
29,55 x 59,4
OD622-016



DRY RIVER light grey skirting
7,2 x 29,55
OD622-022



DRY RIVER light grey
59,4 x 59,4
OP622-004-1

new



DRY RIVER grey
44,4 x 89
OP622-041-1



DRY RIVER grey
29,55 x 59,4
OP622-011-1



DRY RIVER grey mosaic
29,55 x 29,55
OD622-035



DRY RIVER grey steptread
29,55 x 59,4
OD622-017



DRY RIVER grey skirting
7,2 x 29,55
OD622-023



DRY RIVER grey
59,4 x 59,4
OP622-005-1

new



R10

DRY RIVER graphite
29,55 x 59,4
OP622-012-1



R10

DRY RIVER graphite
44,4 x 89
OP622-040-1



R10

DRY RIVER graphite
59,4 x 59,4
OP622-006-1



R10

DRY RIVER graphite steptread
29,55 x 59,4
OD622-018



DRY RIVER graphite mosaic
29,55 x 29,55
OD622-036



DRY RIVER graphite skirting
7,2 x 29,55
OD622-024

p#
302
303

Dry River
45x90

new



DRY RIVER brown
44,4 x 89
OP622-038-1



DRY RIVER brown
29,55 x 59,4
OP622-009-1

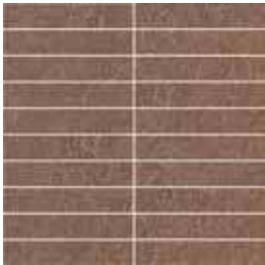

DRY RIVER brown mosaic
29,55 x 29,55
OD622-033



DRY RIVER brown steptread
29,55 x 59,4
OD622-015



DRY RIVER brown skirting
7,2 x 29,55
OD622-021



DRY RIVER brown
59,4 x 59,4
OP622-003-1



cm	cm	pcs	m ²	kg	kg/m ²	m ²	cm	cm	pcs
44,4x89	1,1	3	1,18	29,0	24,55	21,24	7,2x59,4	1	14
59,4x59,4	1	5	1,76	41,25	23,44	35,2			
29,55x59,4	1	8	1,4	33	23,57	44,8			
29,55x59,4 steptread	1	8	-	-	-	-			
29,5x29,5 mosaic	1	12	-	-	-	-			

R10 non-slip class

frost-resistant tile

p#
304
305



new

Dusk
modern

45x90

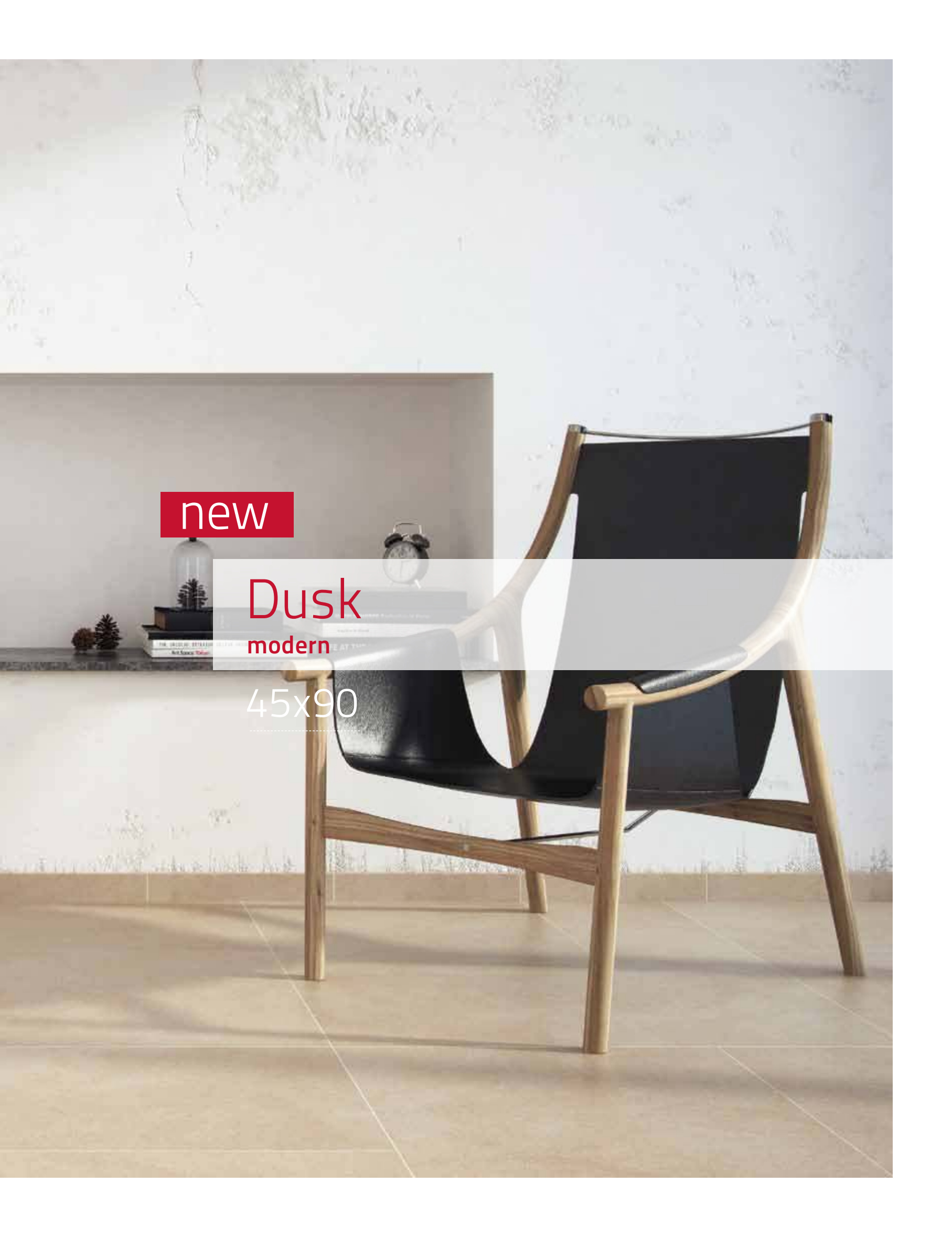



DUSK grey
59,3 x 59,3
OP637-011-1



DUSK grey
44,4 x 89
OP637-009-1



DUSK grey textile
44,4 x 89
OP637-013-1

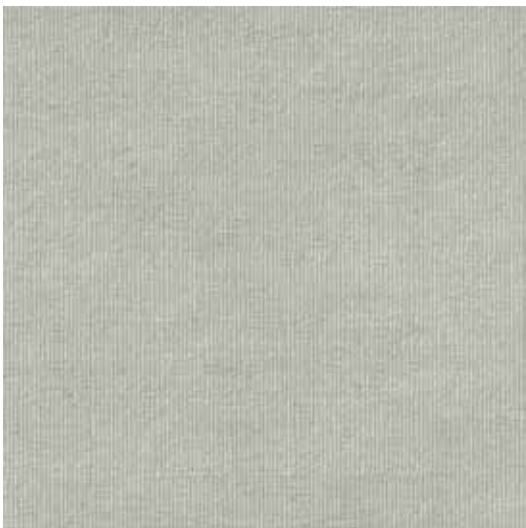
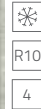

DUSK grey textile
59,3 x 59,3
OP637-015-1



DUSK grey
29 x 59,3
OP637-019-1



DUSK grey textile
29 x 59,3
OP637-020-1



p#
306
307

new

Dusk

45x90



DUSK beige
44,4 x 89
OP637-001-1



DUSK beige
59,3 x 59,3
OP637-003-1



DUSK beige textile
44,4 x 89
OP637-005-1



DUSK beige textile
59,3 x 59,3
OP637-007-1



DUSK beige
29 x 59,3
OP637-017-1



DUSK beige textile
29 x 59,3
OP637-018-1



matt tiles



rectified tiles



structured tiles

cm	cm	pcs	m ²	kg	kg/m ²	m ²	cm	cm	pcs
44,4x89	1,2	3	1,18	28,97	24,55	21,24	29x29,5 mosaic	1	10
59,3x59,3	1,0	5	1,76	42,5	24,15	35,2			
29x59,3	1,0	7	1,2	28,0	23,33	38,4			

p#
308
309





new

Equinox
modern

45x90

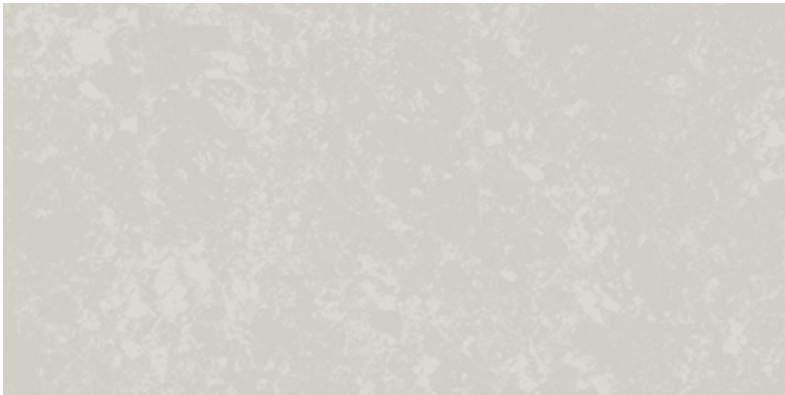

EQUINOX white
44,4 x 89
OP638-005-1

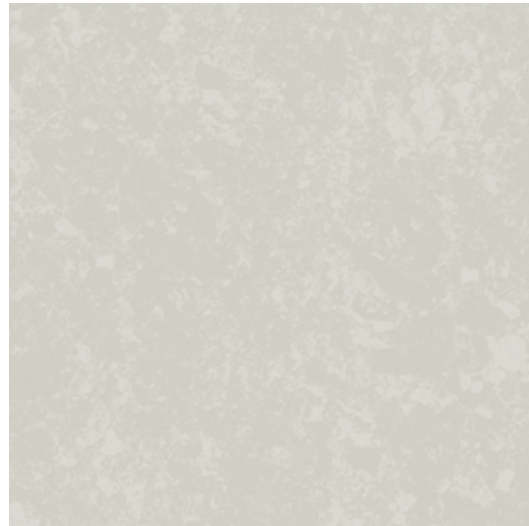

EQUINOX white
59,3 x 59,3
OP638-007-1



EQUINOX white
21,8 x 89
OP638-014-1

p#
310
311

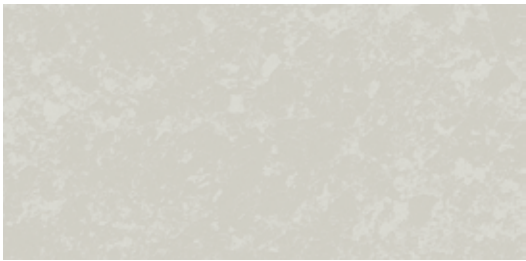

EQUINOX white
29 x 59,3
OP638-015-1

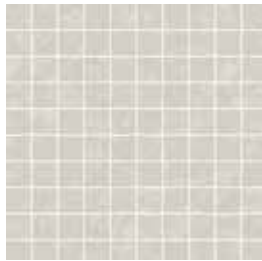

EQUINOX white mosaic square
29 x 29
OD638-011



EQUINOX mix mosaic belt
29 x 29,5
OD638-020



EQUINOX white skirting
7,2 x 59,3
OD638-018

new

Equinox
45x90



EQUINOX black
59,3 x 59,3
OP638-003-1

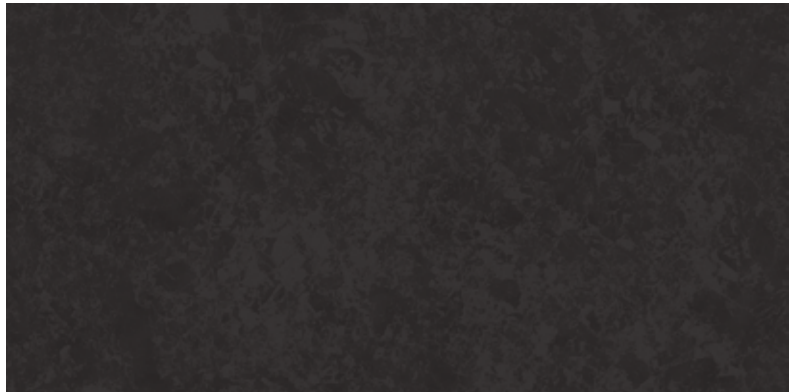

EQUINOX black
44,4 x 89
OP638-001-1



EQUINOX black
21,8 x 89
OP638-012-1

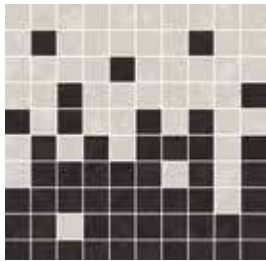

EQUINOX mix mosaic square
29 x 29
OD638-010

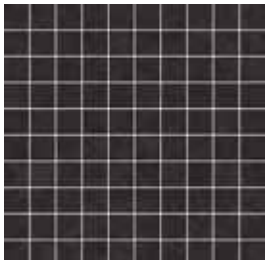

EQUINOX black mosaic square
29 x 29
OD638-009



EQUINOX black
29 x 59,3
OP638-013-1



EQUINOX black skirting
7,2 x 59,3
OD638-019



cm	cm	pcs	m ²	kg	kg/m ²	m ²	cm	cm	pcs
44,4x89	1,2	3	1,18	28,97	24,55	21,24	29x29,5 mosaic	1	12
21,8x89	1,2	5	0,97	23,81	24,55	23,28	7,2x59,3	1	14
59,3x59,3	1,0	5	1,76	42,5	24,15	35,2			
29x59,3	1,0	7	1,2	28,0	23,33	38,4			



p#
312
313



new

Urban Mix

modern

45x90



p#
314
315

new

Urban Mix

45x90



URBAN MIX cream
44,4 x 89
OP639-009-1



URBAN MIX cream
29,55 x 59,4
OP639-039-1



URBAN MIX cream
21,8 x 89
OP639-038-1



URBAN MIX cream
59,4 x 59,4
OP639-011-1

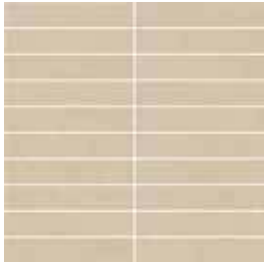

URBAN MIX cream mosaic
29,55 x 29,55
OD639-024



URBAN MIX cream skirting
7,2 x 59,4
OD639-025



URBAN MIX cream
19 x 59,4
OP639-046-1



URBAN MIX cream steptread
29,55 x 59,4
OD639-026





URBAN MIX beige
29,55 x 59,4
OP639-037-1



R10



URBAN MIX beige
44,4 x 89
OP639-001-1



R10



URBAN MIX beige
59,4 x 59,4
OP639-003-1



R10



URBAN MIX beige
21,8 x 89
OP639-036-1



R10



URBAN MIX beige skirting
7,2 x 59,4
OD639-022



R10

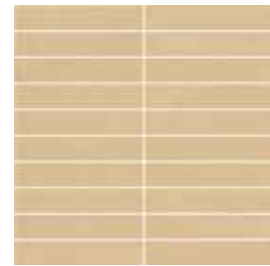

URBAN MIX beige mosaic
29,55 x 29,55
OD639-021



R10



URBAN MIX beige steptread
29,55 x 59,4
OD639-023



R10



URBAN MIX beige
19 x 59,4
OP639-047-1



R10

p#
316
317

new

Urban Mix

45x90



URBAN MIX light grey
44,4 x 89
OP639-017-1



URBAN MIX light grey
29,55 x 59,4
OP639-045-1



URBAN MIX light grey
21,8 x 89
OP639-044-1



URBAN MIX light grey
59,4 x 59,4
OP639-019-1

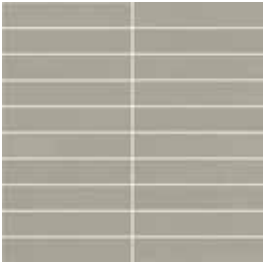

URBAN MIX light grey mosaic
29,55 x 29,55
OD639-033



URBAN MIX light grey skirting
7,2 x 59,4
OD639-034

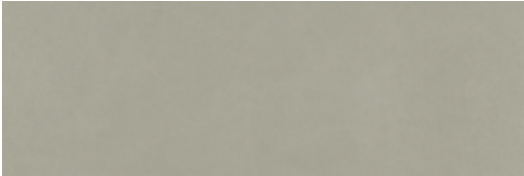

URBAN MIX light grey
19 x 59,4
OP639-048-1



URBAN MIX light grey steptread
29,55 x 59,4
OD639-035





URBAN MIX grey
29,55 x 59,4
OP639-043-1



URBAN MIX grey
44,4 x 89
OP639-013-1



URBAN MIX grey
59,4 x 59,4
OP639-015-1



URBAN MIX grey
21,8 x 89
OP639-042-1



URBAN MIX grey skirting
7,2 x 59,4
OD639-031

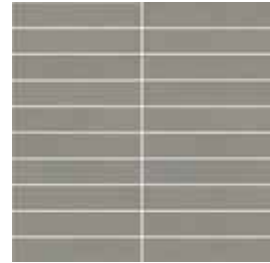

URBAN MIX grey mosaic
29,55 x 29,55
OD639-030



URBAN MIX grey steptread
29,55 x 59,4
OD639-032

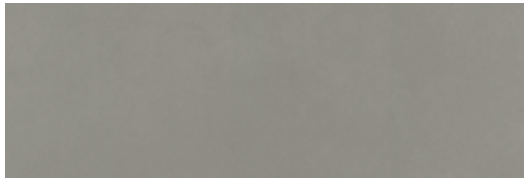

URBAN MIX grey
19 x 59,4
OP639-049-1

p#
318
319

new

Urban Mix

45x90



URBAN MIX graphite
44,4 x 89
OP639-005-1



URBAN MIX graphite
29,55 x 59,4
OP639-041-1



URBAN MIX graphite
21,8 x 89
OP639-040-1



URBAN MIX graphite
59,4 x 59,4
OP639-007-1

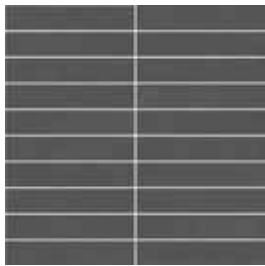

URBAN MIX graphite mosaic
29,55 x 29,55
OD639-027



URBAN MIX graphite skirting
7,2 x 59,4
OD639-028



URBAN MIX graphite
19 x 59,4
OP639-050-1



URBAN MIX graphite stepread
29,55 x 59,4
OD639-029



matt tiles



rectified tiles

cm	cm	pcs	m ²	kg	kg/m ²	m ²	cm	cm	pcs
44,4x89	1,1	3	1,18	28,97	24,55	21,24	7,2x59,4	1	14
21,8x89	1,1	5	0,97	23,81	24,55	23,28			
59,4x59,4	1	5	1,76	41,25	23,44	35,2			
29,55x59,4	1	8	1,4	33,0	23,57	44,8			
19x59,4	1	8	0,9	21,21	23,57	43,2			
29,55x59,4 step	1	8	-	-	-	-			
29,55x29,55 mosaic	1	12	-	-	-	-			

p#
320
321



new

Legno Moderno

modern

15x90





p#
322
323

new

Legno Moderno

15x90



LEGNO MODERNO white
14,7x89,5
MT007-001-1

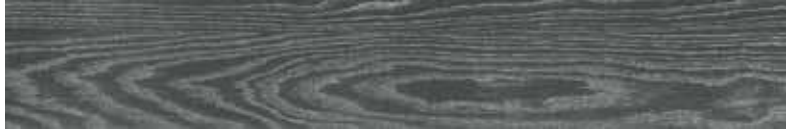

LEGNO MODERNO platinum
14,7x89,5
MT007-004-1















LEGNO MODERNO gold
14,7x89,5
MT007-003-1



LEGNO MODERNO venge
14,7x89,5
MT007-002-1

 matt tiles  rectified tiles

									
cm	cm	pcs	m ²	kg	kg/m ²	m ³	cm	cm	pcs
14,7 x 89,5	1,1	8	1,05	26,04	24,8	16,8			

 abrasion-resistance class  non-slip class  frost-resistant tile

p#
324
325



A modern living room featuring a dark wood wall with a large TV. The room includes a dining table with black chairs, a cowhide rug, and a floor lamp. The text 'Artwood modern 60x60' is overlaid on the image.

Artwood

modern

60x60

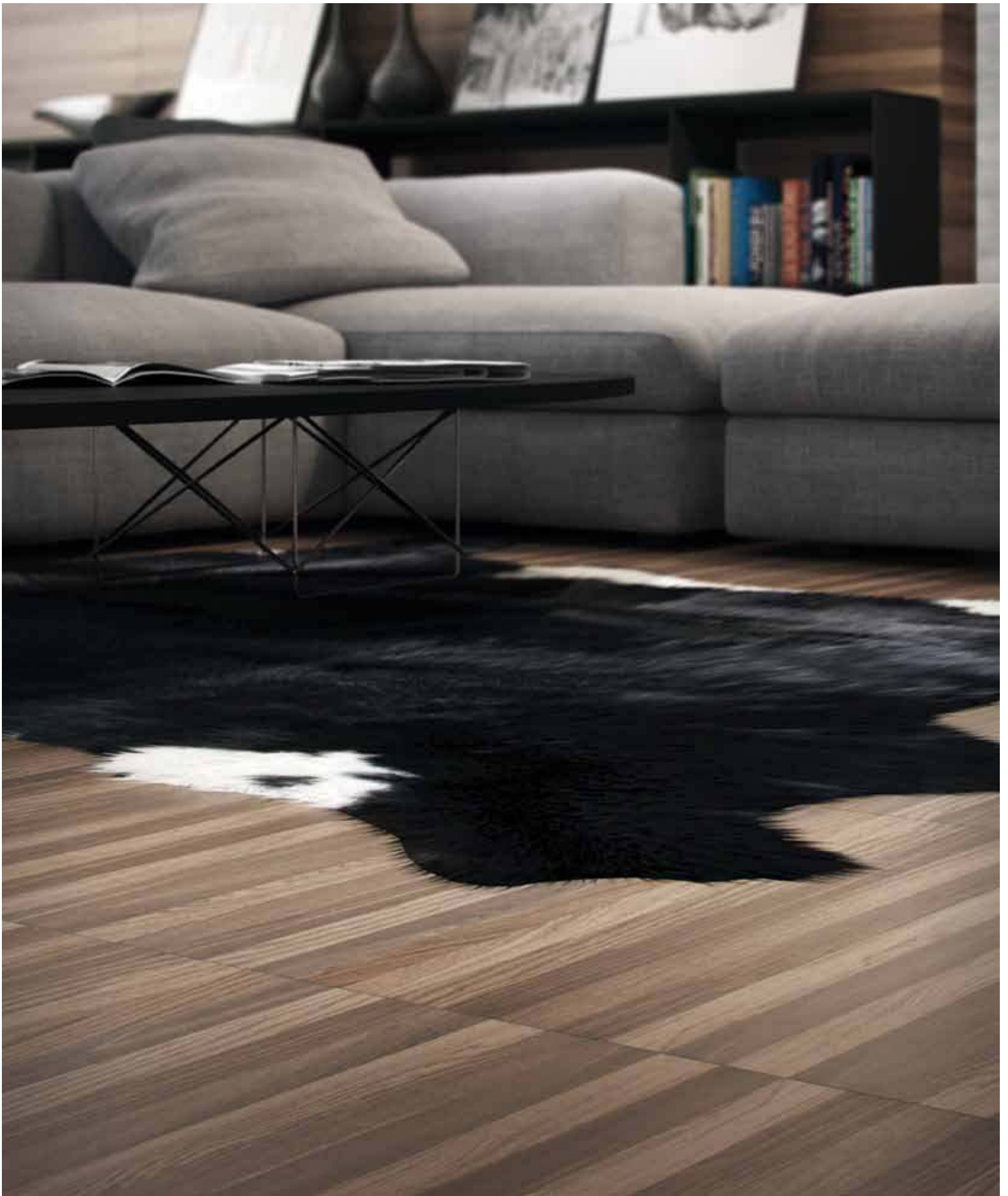

p#
326
327

Artwood
60x60



ARTWOOD pine mosaic
59,3 x 59,3
OP363-001-1



ARTWOOD nut mosaic
59,3 x 59,3
OP363-002-1



ARTWOOD pine board
59,3 x 59,3
OP363-003-1



ARTWOOD nut board
59,3 x 59,3
OP363-004-1



matt tiles



rectified tiles

cm	cm	pcs	m ²	kg	kg/m ²	m ²	cm	cm	pcs
59,3x59,3	1,0	5	1,76	40,83	23,2	35,2			



abrasion-resistance class



non-slip class



frost-resistant tile



p#
328
329



new

Creamy Touch

modern

60x60



p#
330
331

new

Creamy Touch

60x60



CREAMY TOUCH structure
29 x 59,3
OP635-010-1



CREAMY TOUCH
29 x 59,3
OP635-008-1



CREAMY TOUCH belt
29 x 59,3
OD635-012













CREAMY TOUCH pattern
29 x 59,3
OP635-009-1



CREAMY TOUCH
59,3 x 59,3
OP635-006-1



 matt tiles
  structured tiles
  rectified tiles

 cm	 cm	 pcs	 m ²	 kg	 kg/m ²	 m ²	 cm	 cm	 pcs
59,3x59,3	1	5	1,76	42,5	24,15	35,2			
29x59,3	1,1	7	1,2	22,8	19,0	38,4			
29x59,3 structure	1,1	7	1,2	22,8	19,0	38,4			
29x59,3 mosaic	1	6	-	-	-	-			



abrasion-resistance class



non-slip class



frost-resistant tile



p#
332
333



Damasco

modern

60x60

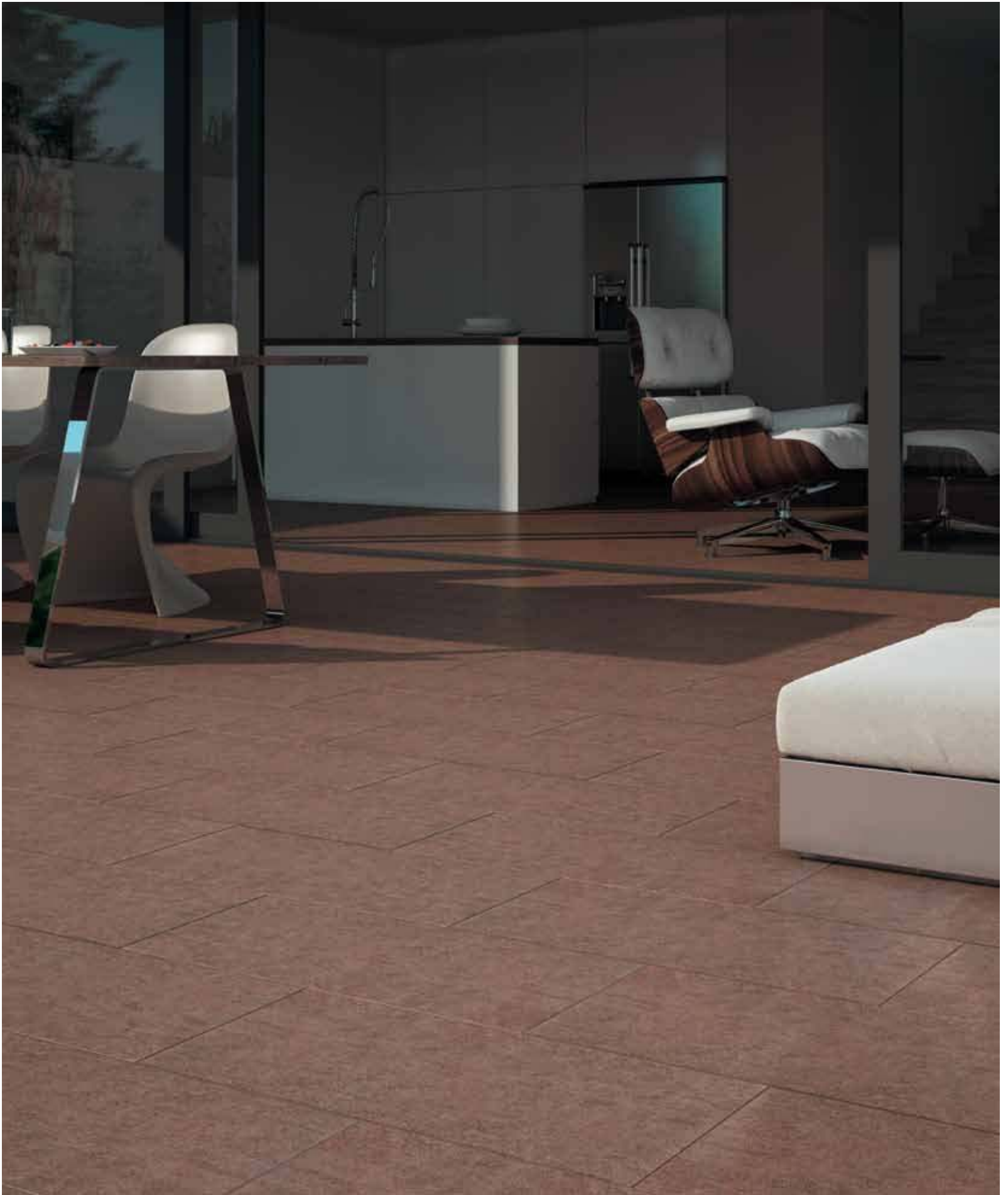

p#
334
335

Damasco

60x60



DAMASCO vanilla
29,7 x 29,7
OP067-005-1



DAMASCO vanilla
29,7 x 59,8
OP067-018-1



DAMASCO anthracite
29,7 x 29,7
OP067-001-1



DAMASCO anthracite
29,7 x 59,8
OP067-022-1



DAMASCO mocca
29,7 x 29,7
OP067-004-1



DAMASCO mocca
29,7 x 59,8
OP067-020-1



DAMASCO anthracite
59,8 x 59,8
OP067-030-1



DAMASCO mix border
7,3 x 34,7
OD067-027



DAMASCO vanilla
59,8 x 59,8
OP067-028-1



DAMASCO mocca
59,8 x 59,8
OP067-029-1



cm	cm	pcs	m ²	kg	kg/m ²	m ²	cm	cm	pcs
59,8x59,8	1,0	5	1,79	24,15	43,23	35,8	7,3x34,7	0,85	5
29,7x59,8	0,85	9	1,6	31,33	19,58	51,2			
29,7x29,7	0,8	15	1,32	22,66	17,17	58,08			



abrasion-resistance class



non-slip class



frost-resistant tile

p#
336
337





new

Early Pastels

modern

60x60



p#
338
339

new

Early Pastels

60x60







EARLY PASTELS beige
29 x 59,3
OP647-007-1







EARLY PASTELS beige
59,3 x 59,3
OP647-009-1







EARLY PASTELS beige strips
59,3 x 59,3
OP647-010-1







EARLY PASTELS grey
29 x 59,3
OP647-008-1







EARLY PASTELS grey
59,3 x 59,3
OP647-011-1







EARLY PASTELS grey strips
59,3 x 59,3
OP647-012-1





EARLY PASTELS beige mosaic
29 x 29,5
OD647-015

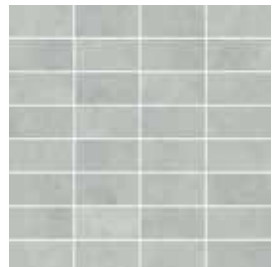



EARLY PASTELS grey mosaic
29 x 29,5
OD647-016

 matt tiles
  rectified tiles

cm	cm	pcs	m ²	kg	kg/m ²	m ²	cm	cm	pcs
59,3x59,3	1	5	1,76	42,5	24,15	35,2			
29x59,3	1	7	1,2	28,0	23,33	38,4			
29x29,5 mosaic	1	11	-	-	-	-			

p#
340
341





Fargo

modern

60x60

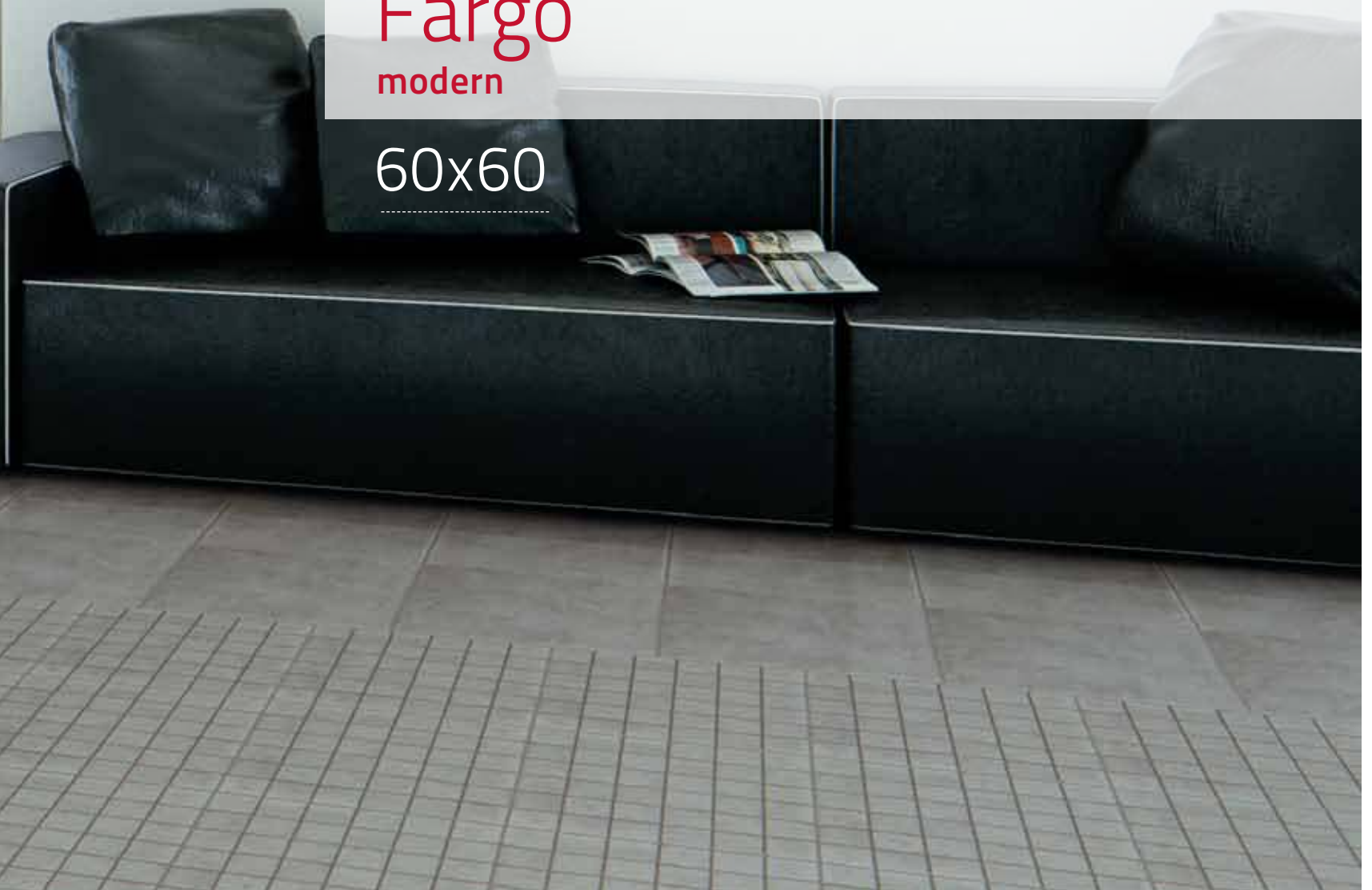

new



FARGO white
59,8x59,8
OP360-013-1

new



FARGO grey
59,8x59,8
OP360-014-1

p#
342
343



FARGO white
29,7 x 59,8
OP360-008-1



FARGO grey
29,7 x 59,8
OP360-007-1

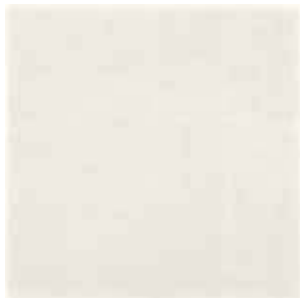

FARGO white
32,6 x 32,6
OP360-012-1



FARGO white mosaic
29,7 x 29,7
OD360-004



FARGO grey
32,6 x 32,6
OP360-011-1



FARGO grey mosaic
29,7 x 29,7
OD360-003

Fargo

60x60

new



FARGO brown
59,8x59,8
OP360-015-1



new



FARGO black
59,8x59,8
OP360-016-1



FARGO brown
29,7 x 59,8
OP360-006-1

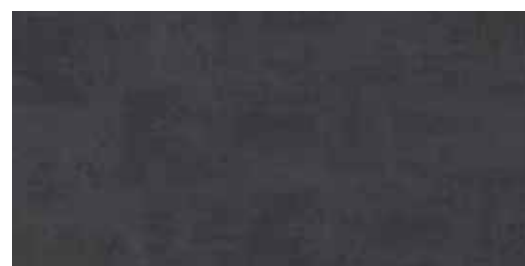

FARGO black
29,7 x 59,8
OP360-005-1



FARGO brown mosaic
29,7 x 29,7
OD360-002



FARGO brown
32,6 x 32,6
OP360-010-1



FARGO black mosaic
29,7 x 29,7
OD360-001



FARGO black
32,6 x 32,6
OP360-009-1



matt tiles

cm	cm	pcs	m ²	kg	kg/m ²	m ²	cm	cm	pcs
59,8x59,8	1,0	5	1,79	43,23	24,15	35,8			
29,7x59,8	0,85	9	1,6	28,75	17,97	51,2			
29,7x29,7 mosaic	0,8	14	-	-	-	-			
32,6x32,6	0,8	12	1,17	21,11	18,04	56,16			

4 3

abrasion-resistance class

R9

non-slip class



frost-resistant tile



p#
344
345



new

Kando

modern

60x60



KANDO anthracite satin 59,4 x 59,4
W164-244-1
KANDO anthracite polished 59,4 x 59,4
W164-250-1



KANDO anthracite satin 29,55 x 59,4
W164-245-1
KANDO anthracite polished 29,55 x 59,4
W164-252-1



KANDO anthracite steptread satin 29,55 x 59,4
WD164-264
KANDO anthracite steptread polished 29,55 x 59,4
WD164-262



KANDO anthracite mosaic strips satin
14,7 x 41
WD164-260



KANDO anthracite skirting satin 7,2 x 59,4
WD164-278
KANDO anthracite skirting polished 7,2 x 59,4
WD164-277

p#
346
347

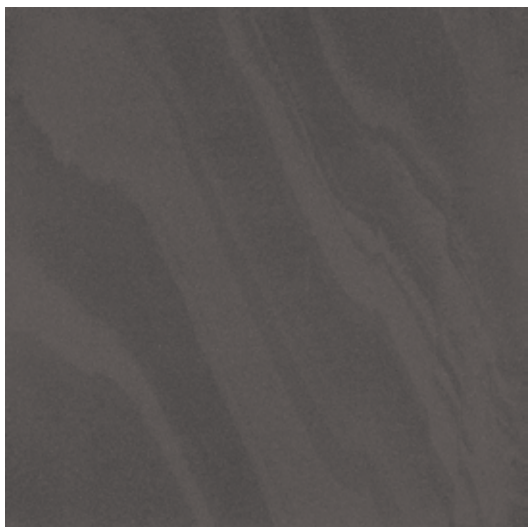

KANDO graphite satin 59,4 x 59,4
W164-247-1
KANDO graphite polished 59,4 x 59,4
W164-251-1

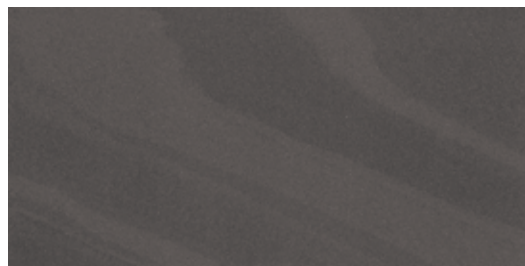

KANDO graphite satin 29,55 x 59,4
W164-248-1
KANDO graphite polished 29,55 x 59,4
W164-253-1



KANDO graphite steptread satin 29,55 x 59,4
WD164-265
KANDO graphite steptread polished 29,55 x 59,4
WD164-263

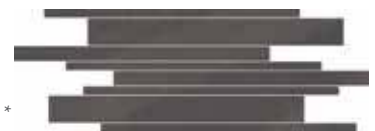

KANDO graphite mosaic strips satin
14,7 x 41
WD164-261



KANDO graphite skirting satin 7,2 x 59,4
WD164-280
KANDO graphite skirting polished 7,2 x 59,4
WD164-279

new

Kando
60x60

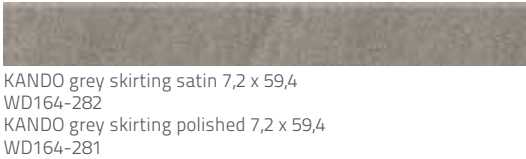
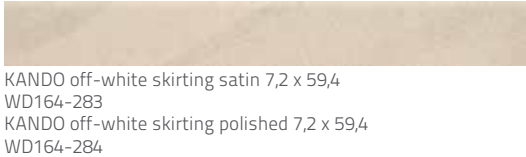

cm	cm	pcs	m ²	kg	kg/m ²	m ²	cm	cm	pcs
29,55x59,4 satin	1	8	1,4	33	23,57	44,8	7,2x59,4	1	14
29,55x59,4 polished.	1	8	1,4	31,29	22,35	44,8	14,7 x 41	1	8
59,4x59,4 satin	1	5	1,76	41,25	23,44	35,2			
59,4x59,4 polished	1	5	1,76	39,74	22,58	35,2			

* R10 - only matt tiles

R10 non-slip class

❄️ frost-resistant tile

p#
348
349



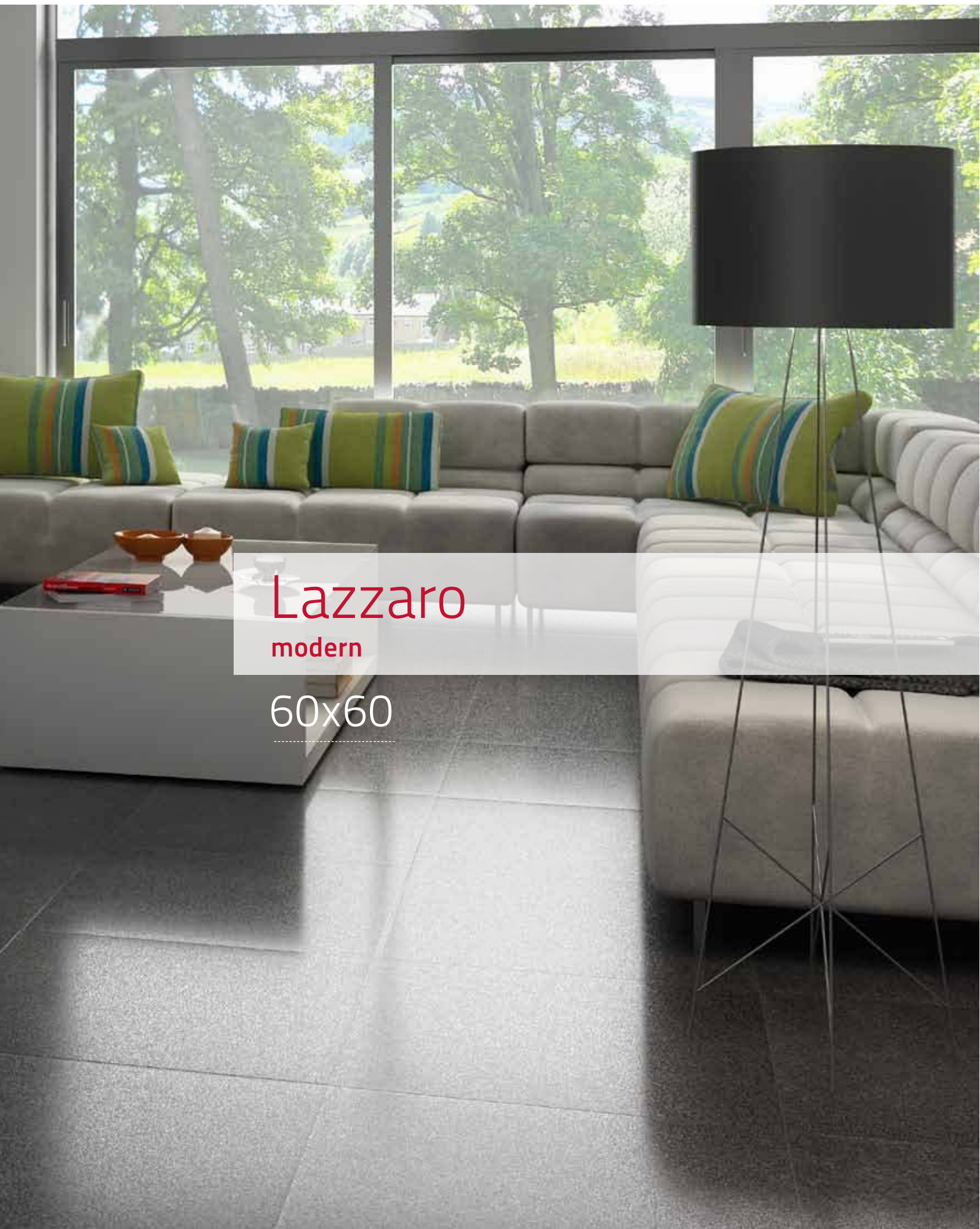

Lazzaro

modern

60x60



p#
350
351

Lazzaro
60x60



LAZZARO white lappato
59,3 x 59,3
OP343-001-1



LAZZARO black lappato
59,3 x 59,3
OP343-002-1



LAZZARO border modern
6,7 x 59,3
OD343-004



LAZZARO corner modern
6,7 x 6,7
OD343-003



glossy tiles



rectified tiles

cm	cm	pcs	m ²	kg	kg/m ²	m ²	cm	cm	pcs
59,3x59,3	1	5	1,76	42,5	24,15	35,2	6,7x59,3	1	10
							6,7x6,7	1	10



abrasion-resistance class



frost-resistant tile

p#
352
353





new

Light Marble

modern

60x60



p#
354
355

new

Light Marble

60x60



LIGHT MARBLE grey
29 x 59,3
OP636-011-1



LIGHT MARBLE beige
29 x 59,3
OP636-009-1



LIGHT MARBLE grey structure
29 x 59,3
OP636-012-1



LIGHT MARBLE beige structure
29 x 59,3
OP636-010-1



LIGHT MARBLE grey
59,3 x 59,3
OP636-008-1



LIGHT MARBLE beige
59,3 x 59,3
OP636-007-1



cm	cm	pcs	m ²	kg	kg/m ²	m ²	cm	cm	pcs
59,3x59,3	1	5	1,76	42,5	24,15	35,2			
29x59,3	1,1	7	1,2	22,8	19,0	38,4			
29x59,3 structure	1,1	7	1,2	22,8	19,0	38,4			



abrasion-resistance class



non-slip class



frost-resistant tile



p#
356
357



new

Moondust
modern

60x60

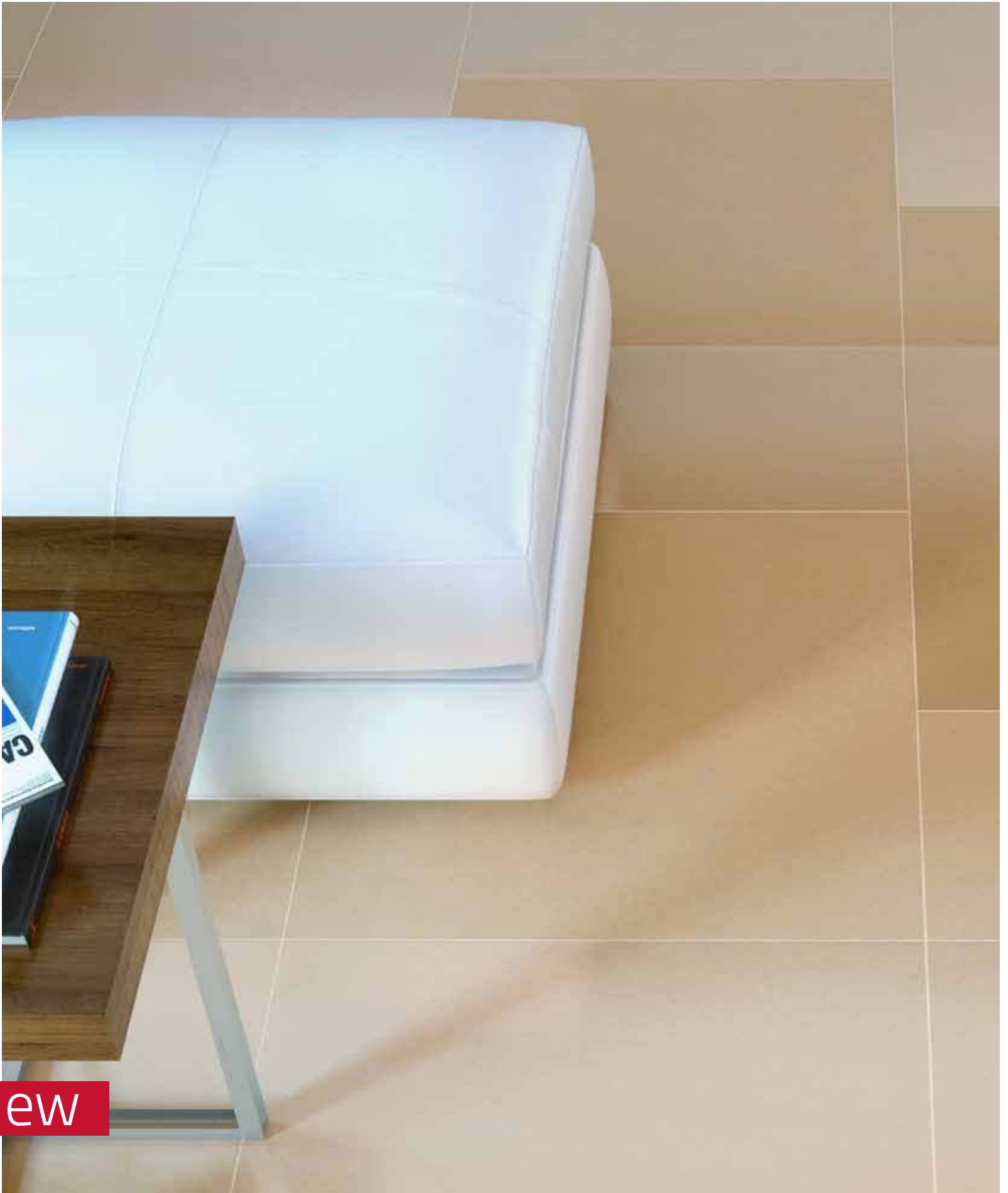

p#
358
359

new

Moondust

60x60

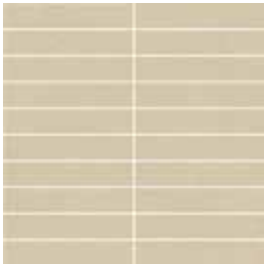

MOONDUST cream mosaic
29,5 x 29,5
OD646-055



MOONDUST cream 29,55 x 59,4
OP646-019-1
MOONDUST cream polished 29,55 x 59,4
OP646-031-1



R10*



MOONDUST cream 59,4 x 59,4
OP646-013-1
MOONDUST cream polished 59,4 x 59,4
OP646-025-1



R10*



MOONDUST cream steptread
29,55 x 59,4
OP646-037-1



R10



MOONDUST cream skirting 7,2 x 59,4
OD646-043
MOONDUST cream skirting polished 7,2 x 59,4
OD646-049

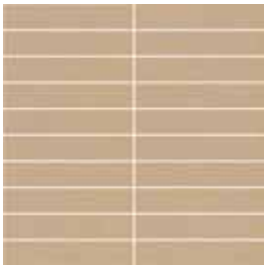

MOONDUST mocca mosaic
29,5 x 29,5
OD646-057



MOONDUST mocca 29,55 x 59,4
OP646-021-1
MOONDUST mocca polished 29,55 x 59,4
OP646-033-1



R10*



MOONDUST mocca 59,4 x 59,4
OP646-015-1
MOONDUST mocca polished 59,4 x 59,4
OP646-027-1



R10*



MOONDUST mocca steptread
29,55 x 59,4
OP646-039-1



R10



MOONDUST mocca skirting 7,2 x 59,4
OD646-045
MOONDUST mocca skirting polished 7,2 x 59,4
OD646-051





MOONDUST beige 59,4 x 59,4
 OP646-014-1
 MOONDUST beige polished 59,4 x 59,4
 OP646-026-1



MOONDUST beige skirting 7,2 x 59,4
 OD646-044
 MOONDUST beige skirting polished 7,2 x 59,4
 OD646-050



MOONDUST beige 29,55 x 59,4
 OP646-020-1
 MOONDUST beige polished 29,55 x 59,4
 OP646-032-1



MOONDUST beige steptread
 29,55 x 59,4
 OP646-038-1

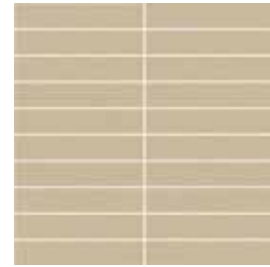

MOONDUST beige mosaic
 29,5 x 29,5
 OD646-056



p#
 360
 361



MOONDUST light grey 59,4 x 59,4
 OP646-016-1
 MOONDUST light grey polished 59,4 x 59,4
 OP646-028-1



MOONDUST light grey 29,55 x 59,4
 OP646-022-1
 MOONDUST light grey polished 29,55 x 59,4
 OP646-034-1



MOONDUST light grey steptread
 29,55 x 59,4
 OP646-040-1

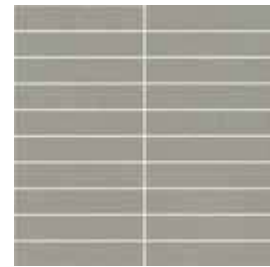

MOONDUST light grey mosaic
 29,5 x 29,5
 OD646-058



MOONDUST light grey 7,2 x 59,4
 OD646-046
 MOONDUST light grey polished 7,2 x 59,4
 OD646-052



new

Moondust

60x60



MOONDUST dark grey mosaic
29,5 x 29,5
OD646-059



MOONDUST dark grey 29,55 x 59,4
OP646-023-1
MOONDUST dark grey polished 29,55 x 59,4
OP646-035-1



R10*



MOONDUST dark grey 59,4 x 59,4
OP646-017-1
MOONDUST dark grey polished 59,4 x 59,4
OP646-029-1



R10*



MOONDUST dark grey steptread
29,55 x 59,4
OP646-041-1



R10



MOONDUST dark grey skirting 7,2 x 59,4
OD646-047
MOONDUST dark grey skirting polished 7,2 x 59,4
OD646-053

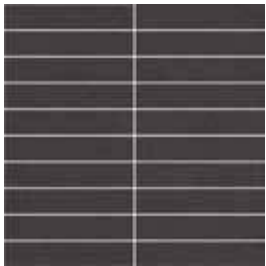

MOONDUST black mosaic
29,5 x 29,5
OD646-060

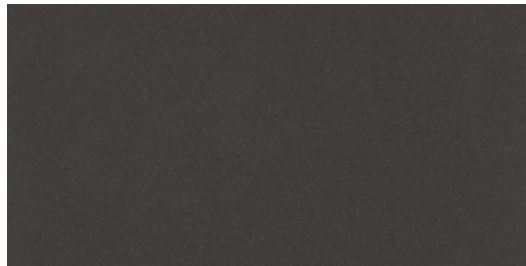

MOONDUST black 29,55 x 59,4
OP646-024-1
MOONDUST mocca polished 29,55 x 59,4
OP646-036-1



R10*

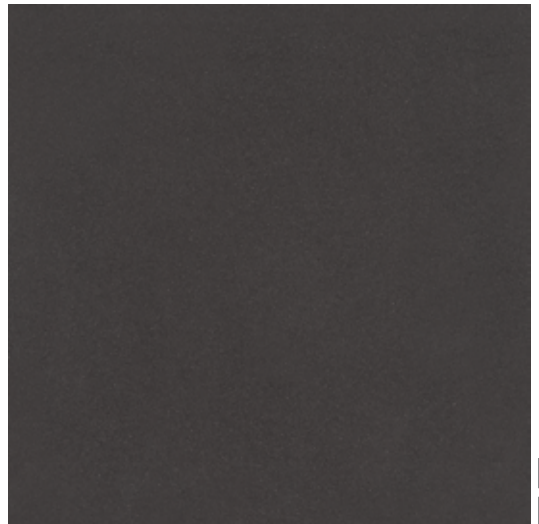

MOONDUST black 59,4 x 59,4
OP646-018-1
MOONDUST black polished 59,4 x 59,4
OP646-030-1



R10*



MOONDUST black steptread
29,55 x 59,4
OP646-042-1



R10

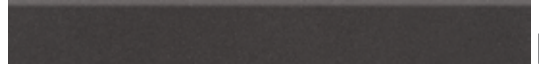

MOONDUST black skirting 7,2 x 59,4
OD646-048
MOONDUST black skirting polished 7,2 x 59,4
OD646-054



glossy tiles



rectified tiles



matt tiles

cm	cm	pcs	m ²	kg	kg/m ²	m ²	cm	cm	pcs
59,4x59,4	1	5	1,76	41,25	23,44	35,2	7,2x59,4	1	14
59,4x59,4 polished	0,9	5	1,76	39,74	22,58	35,2	7,2x59,4 polished	0,9	14
29,55x59,4	1	8	1,4	33,0	23,57	44,8	29,5x29,5	1	12
29,55x59,4 polished	0,9	8	1,4	31,29	22,35	44,8			
29,55x59,4 step.	1	8	1,4	33,0	23,57	44,8			

* R10 - only matt tiles

R10 non-slip class

frost-resistant tile



p#
362
363



Visione
modern

60x60

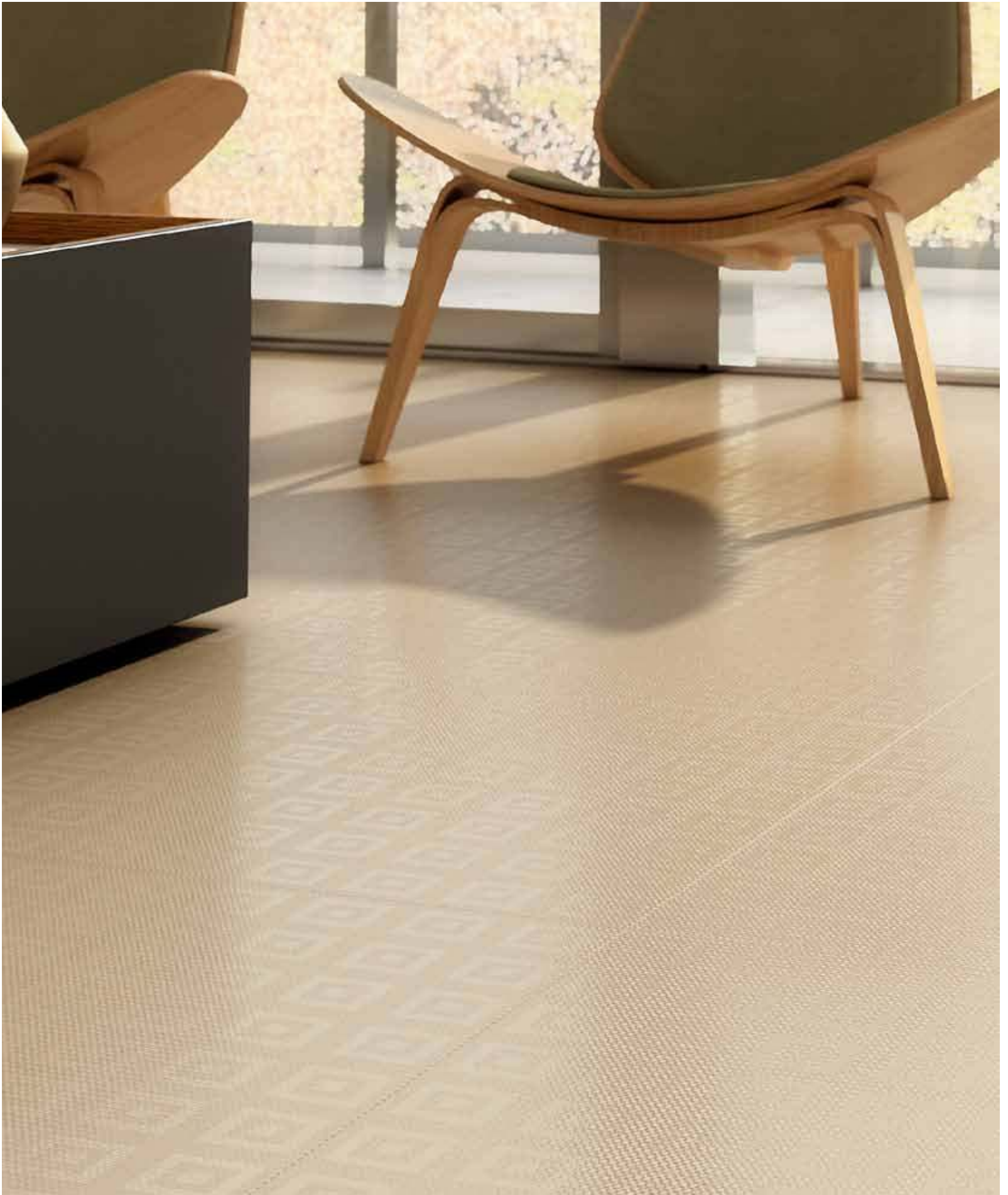

p#
364
365

Visione
60x60



VISIONE cream
59,3 x 59,3
OP055-001-1



VISIONE beige
59,3 x 59,3
OP055-002-1

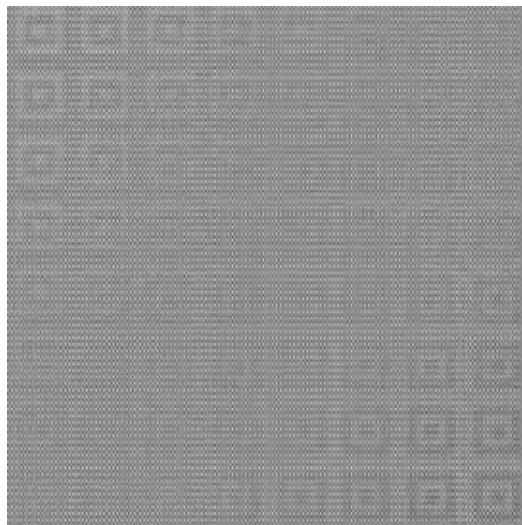

VISIONE grey
59,3 x 59,3
OP055-004-1

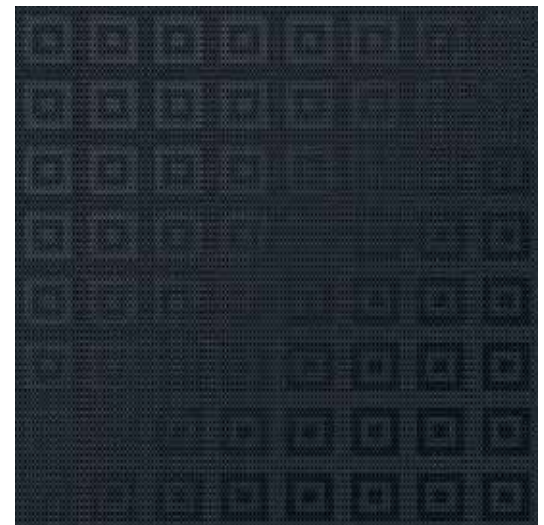

VISIONE black
59,3 x 59,3
OP055-005-1



glossy tiles



rectified tiles



structured tiles

cm	cm	pcs	m ²	kg	kg/m ²	m ³	cm	cm	pcs
59,3x59,3	1	5	1,76	42,5	24,15	35,2			

4 3 abrasion-resistance class

R9 non-slip class

frost-resistant tile

p#
366
367



A modern hanging chair with a black and white striped fabric and a black cushioned seat is suspended from a wooden beam on a wooden deck. The deck is bordered by a concrete wall with a vertical slat railing. A yellow and white coffee cup sits on the ledge. In the foreground, there is a stack of magazines and a pair of shoes. The background shows lush green trees and a clear sky.

Allwood
modern

30x60



p#
368
369

Allwood
30x60



4

ALLWOOD pine
14,8 x 59,8
OP361-001-1



4

ALLWOOD pine
29,7 x 59,8
OP361-005-1



4

ALLWOOD oak
14,8 x 59,8
OP361-002-1



4

ALLWOOD oak
29,7 x 59,8
OP361-006-1



3

ALLWOOD teak
14,8 x 59,8
OP361-003-1



3

ALLWOOD teak
29,7 x 59,8
OP361-007-1



3

ALLWOOD nut
14,8 x 59,8
OP361-004-1



3

ALLWOOD nut
29,7 x 59,8
OP361-008-1



matt
tiles

cm	cm	pcs	m ²	kg	kg/m ²	m ²	cm	cm	pcs
14,8 x 59,8	8,5	10	0,88	18,2	20,57	31,68			
29,7 x 59,8	8,5	9	1,6	31,01	19,38	51,2			

p#
370
371





Karoo
modern

30x60



p#
372
373

Karoo
30x60



KAROO cream mosaic
29,7 x 29,7
OD193-007



KAROO cream
29,7 x 59,8
OP193-002-1



KAROO beige mosaic
29,7 x 29,7
OD193-008



KAROO beige
29,7 x 59,8
OP193-001-1



KAROO grey mosaic
29,7 x 29,7
OD193-009



KAROO grey
29,7 x 59,8
OP193-003-1



new

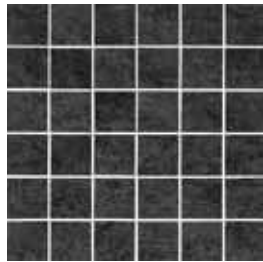

KAROO graphite mosaic
29,7 x 29,7
OD193-012



KAROO graphite
29,7 x 59,8
OP193-010-1













new



matt tiles



structured tiles

 cm	 cm	 pcs	 m ²	 kg	 kg/m ²	 m ²	 cm	 cm	 pcs
29,7x59,8	0,85	9	1,6	30,5	19,06	51,2			
29,7x29,7 mosaic	0,85	15	-	-	-	-			



5 4 abrasion-resistance class



R10 non-slip class



frost-resistant tile



p#
374
375



Livingwood

modern

30x60

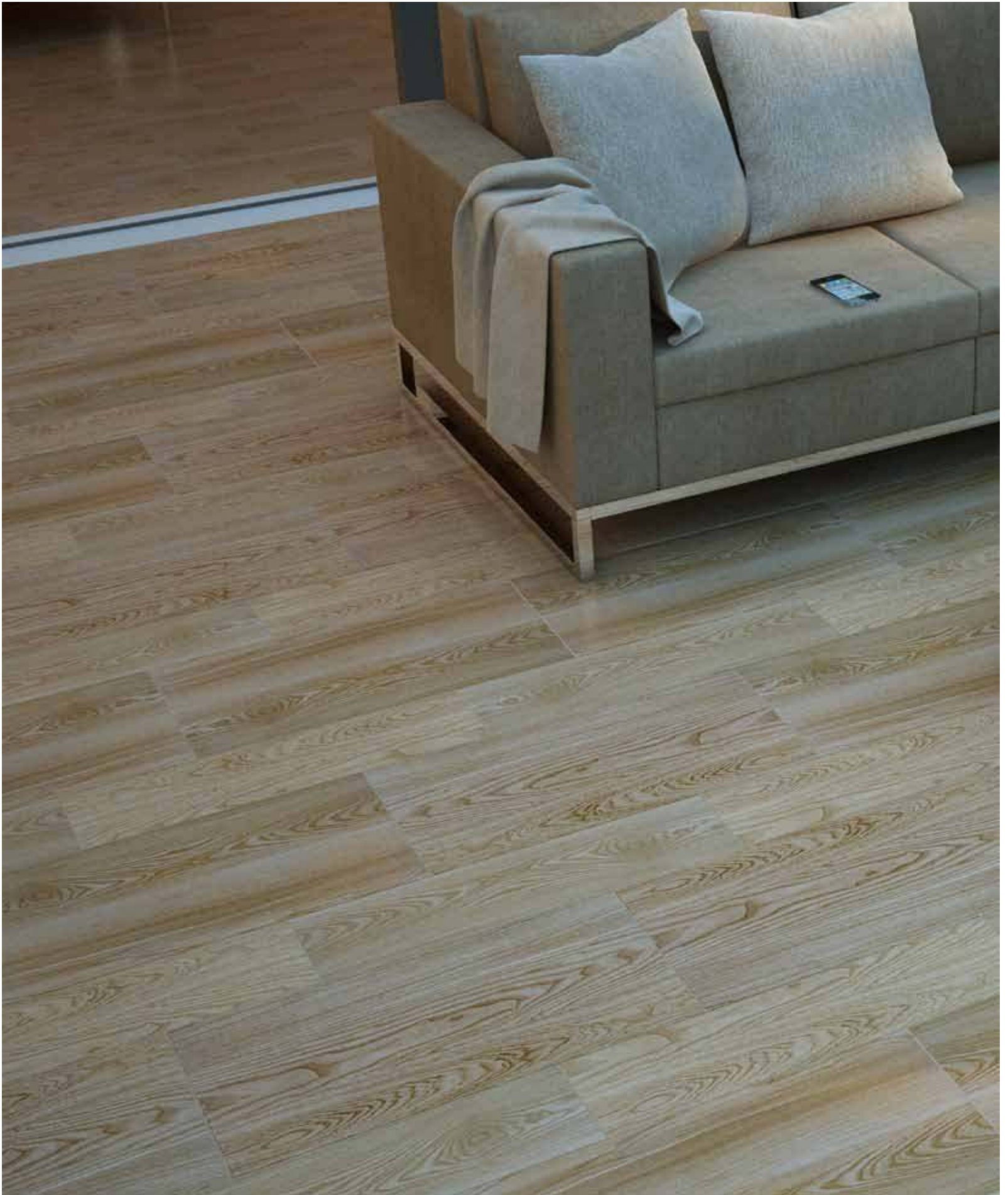

p#
376
377

Livingwood
30x60



LIVINGWOOD maple
14,4 x 59,3
OP364-004-1



R9

4



LIVINGWOOD maple
29 x 59,3
OP364-001-1



R9

4



LIVINGWOOD pine
14,4 x 59,3
OP364-005-1



R9

3



LIVINGWOOD pine
29 x 59,3
OP364-002-1



R9

3



LIVINGWOOD chestnut
14,4 x 59,3
OP364-006-1



R9

3



LIVINGWOOD chestnut
29 x 59,3
OP364-003-1



R9

3



rectified
tiles



matt
tiles

cm	cm	pcs	m ²	kg	kg/m ²	m ²	cm	cm	pcs
29x59,3	1,0	7	1,2	28,5	23,75	38,4			
14,4x59,3	1,0	8	0,68	16,15	23,75	28,56			

4 3

abrasion-resistance class

R9

non-slip class



frost-resistant tile



p#
378
379

Deckwood

modern

15x60



DECKWOOD pine
14,8 x 59,8
OP362-001-1



R10

4



DECKWOOD oak
14,8 x 59,8
OP362-002-1



R10

4



DECKWOOD teak
14,8 x 59,8
OP362-003-1



R10

3



DECKWOOD nut
14,8 x 59,8
OP362-004-1



R10

3



structured
tiles



matt
tiles

cm	cm	pcs	m ²	kg	kg/m ²	m ²	cm	cm	pcs
14,8x59,8	0,85	10	0,88	18,2	20,57	31,68			

4

3

abrasion-resistance class

R10

non-slip class



frost-resistant tile



p#
380
381

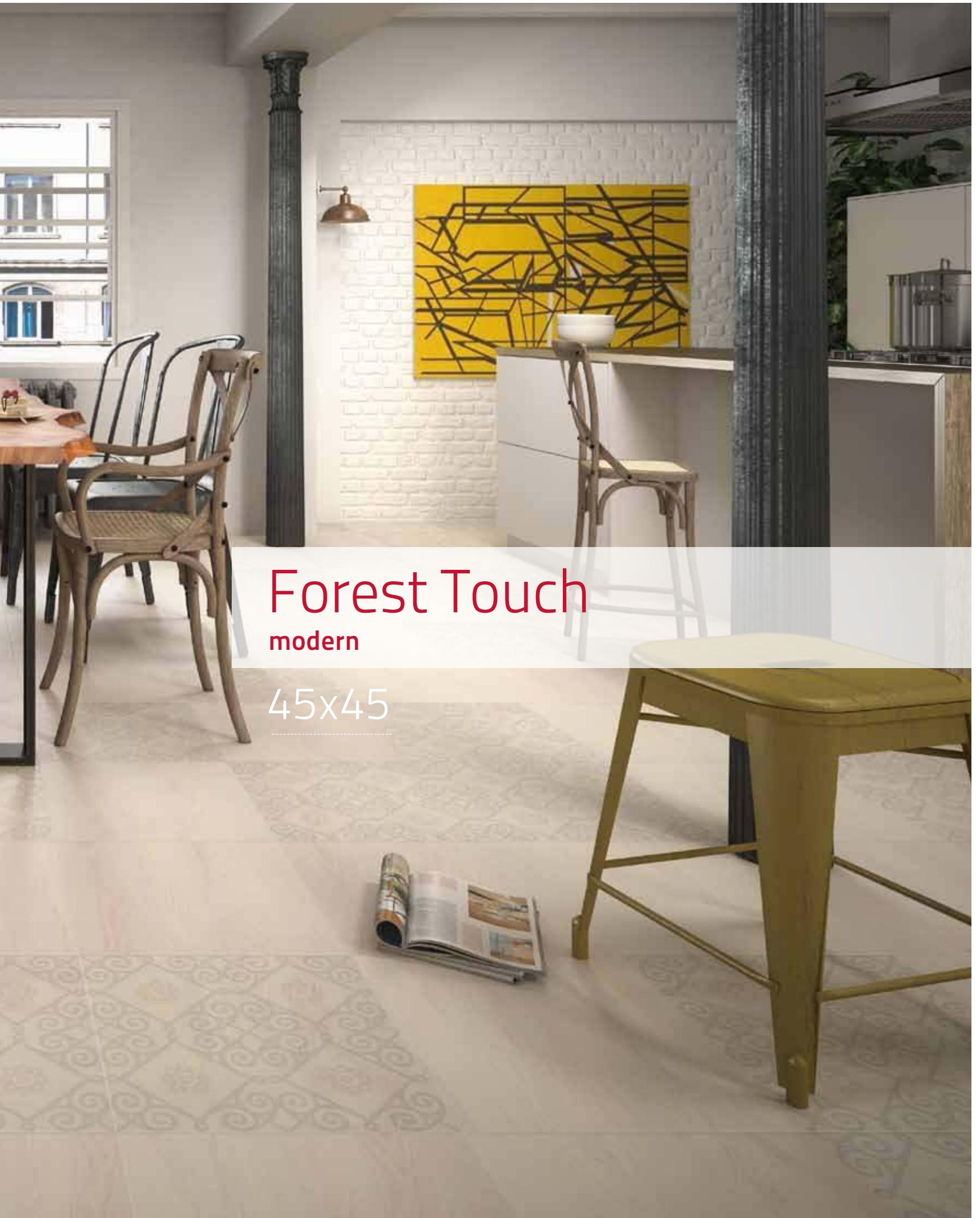

Forest Touch

modern

45x45



p#
382
383

Forest Touch

45x45



FOREST TOUCH cream
45 x 45
OP618-003-1



FOREST TOUCH beige
45 x 45
OP618-001-1



FOREST TOUCH cream carpet
45 x 45
OP618-004-1



FOREST TOUCH beige carpet
45 x 45
OP618-002-1



cm	cm	pcs	m ²	kg	kg/m ²	m ²	cm	cm	pcs
45x45	0,9	8,0	1,62	29,86	18,43	35,64			

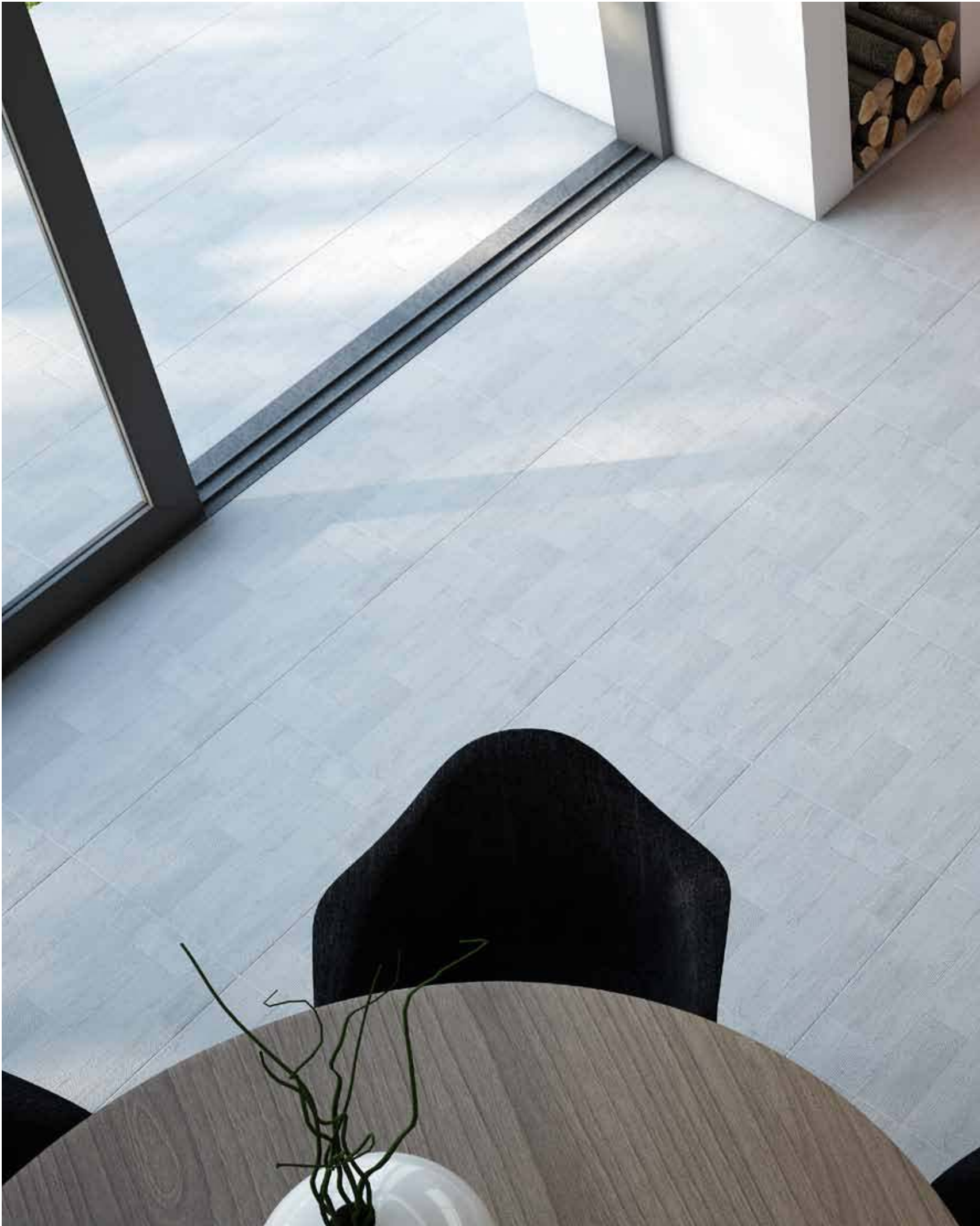

p#
384
385



Scandic Life
modern

45x45

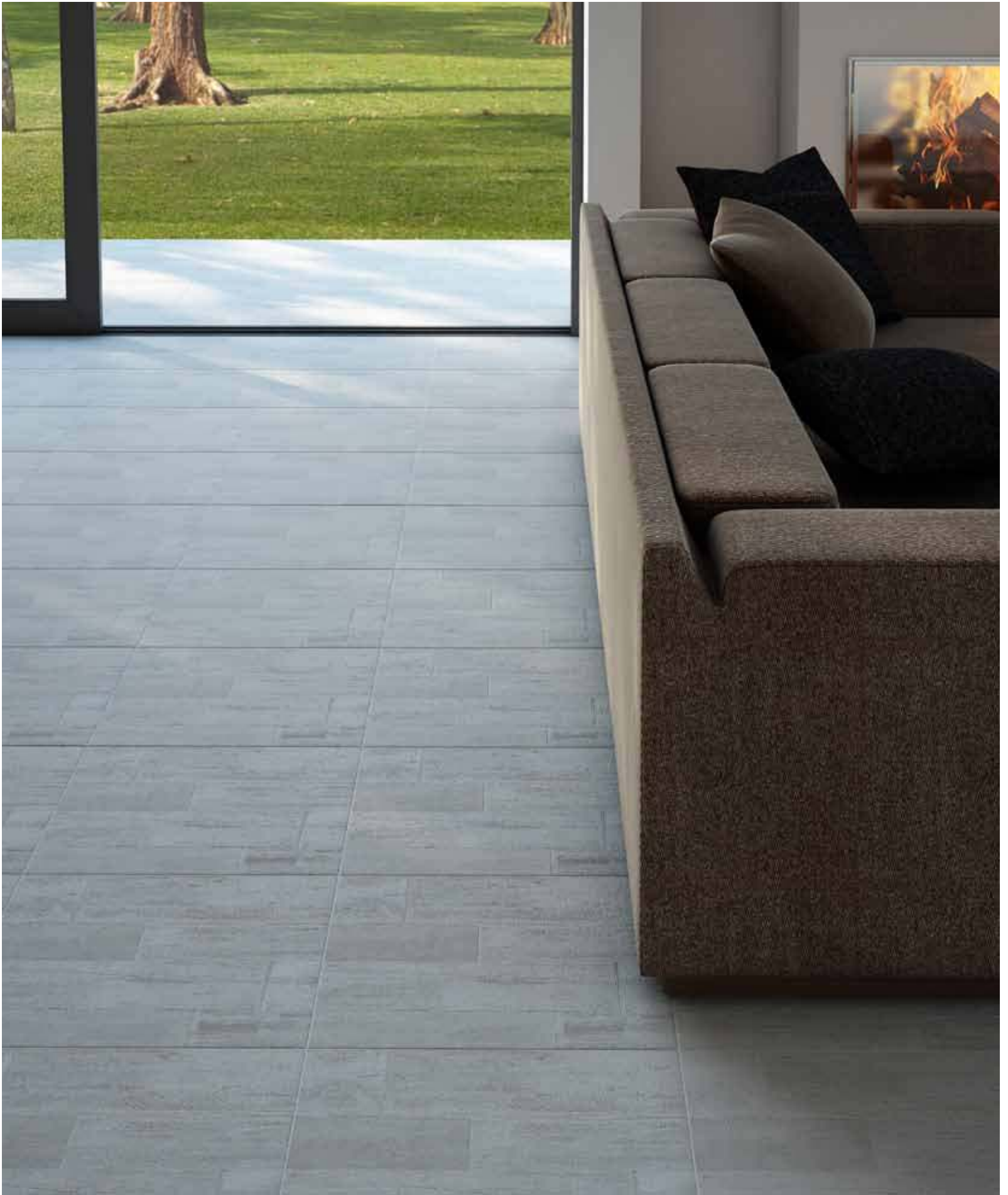

p#
386
387

Scandic Life

45x45



SCANDIC LIFE cream
45 x 45
OP620-002-1



4



SCANDIC LIFE beige
45 x 45
OP620-001-1



4



SCANDIC LIFE light grey
45 x 45
OP620-004-1



4



SCANDIC LIFE grey
45 x 45
OP620-003-1



4



structured
tiles



matt
tiles

cm	cm	pcs	m ²	kg	kg/m ²	m ²	cm	cm	pcs
45x45	0,9	8,0	1,62	29,86	18,43	35,64			

4

abrasion-resistance class



frost-resistant tile



p#
388
389



Silent Stone

modern

45x45



p#
390
391

Silent Stone

45x45



SILENT STONE light grey
45 x 45
OP621-003-1



SILENT STONE grey
45 x 45
OP621-001-1



SILENT STONE light grey carpet
45 x 45
OP621-004-1



SILENT STONE grey carpet
45 x 45
OP621-002-1

matt tiles

cm	cm	pcs	m ²	kg	kg/m ²	m ²	cm	cm	pcs
45x45	0,9	8,0	1,62	29,86	18,43	35,64			



abrasion-resistance class



frost-resistant tile



p#
392
393



Bazalto

modern

40x40



p#
394
395

Bazalto

40x40



BAZALTO cream
39,6 x 39,6
OP059-001-1



4



BAZALTO beige
39,6 x 39,6
OP059-002-1



3



BAZALTO brown
39,6 x 39,6
OP059-003-1



3



BAZALTO graphite
39,6 x 39,6
OP059-004-1



3

matt tiles

cm	cm	pcs	m ²	kg	kg/m ²	m ³	cm	cm	pcs
39,6x39,6	0,85	9	1,41	24,1	17,09	36,66			

4 3

abrasion-resistance class



frost-resistant tile

p#
396
397



new

Basic Palette

modern

30x30





p#
398
399

new

Basic Palette

30x30

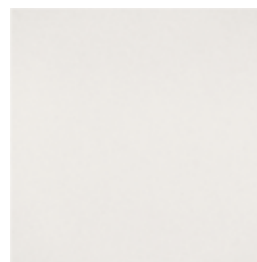

WHITE SEMI-GLOSSY
29,7 x 29,7
OP631-037-1

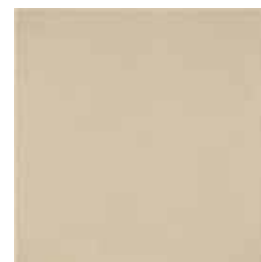

BEIGE SEMI-GLOSSY
29,7 x 29,7
OP631-041-1



WHITE PATTERN B
29,7 x 29,7
OP631-039-1



BEIGE PATTERN B
29,7 x 29,7
OP631-043-1



WHITE PATTERN C
29,7 x 29,7
OP631-040-1



BEIGE PATTERN C
29,7 x 29,7
OP631-044-1



cm	cm	pcs	m ²	kg	kg/m ²	m ²	cm	cm	pcs
29,7 x 29,7	0,8	15	1,32	22,66	17,17	58,08			



4 abrasion-resistance class



R10 non-slip class



frost-resistant tile

p#
400
401



A modern living room interior. In the foreground, a black metal cube coffee table with a dark top holds two books. To the left, a floor lamp with a white conical shade stands on a light-colored rug. In the background, a brown sofa is visible near a window with vertical blinds. To the right, a white built-in bookshelf holds framed pictures and a camera. The ceiling has two recessed spotlights. The floor is highly reflective, showing a clear reflection of the floor lamp.

Kallisto

modern

60x60



KALLISTO cream 59,8 x 59,8
 OP075-070-1
 KALLISTO cream polished 59,4 x 59,4
 OP075-090-1
 KALLISTO cream rect. 59,4 x 59,4
 OP075-078-1



KALLISTO cream 29,7 x 59,8
 OP075-074-1
 KALLISTO cream polished 29,55 x 59,4
 OP075-086-1
 KALLISTO cream rect. 29,55 x 59,4
 OP075-082-1



KALLISTO cream steptread
 29,7 x 59,8
 OP075-094-1



KALLISTO cream skirting
 7,2 x 59,4
 OP075-098

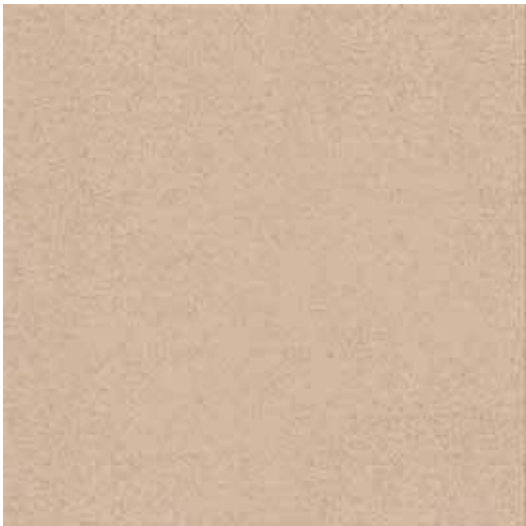

KALLISTO beige 59,8 x 59,8
 OP075-071-1
 KALLISTO beige polished 59,4 x 59,4
 OP075-091-1
 KALLISTO beige rect. 59,4 x 59,4
 OP075-079-1



KALLISTO beige 29,7 x 59,8
 OP075-075-1
 KALLISTO beige polished 29,55 x 59,4
 OP075-087-1
 KALLISTO beige rect. 29,55 x 59,4
 OP075-083-1



KALLISTO beige steptread
 29,7 x 59,8
 OP075-095-1



KALLISTO beige skirting
 7,2 x 59,4
 OP075-099

p#
402
403

Kallisto

60x60



KALLISTO grey skirting
7,2 x 59,4
OP075-100



KALLISTO grey steptread
29,7 x 59,8
OP075-096-1



KALLISTO grey 29,7 x 59,8
OP075-076-1
KALLISTO grey polished 29,55 x 59,4
OP075-088-1
KALLISTO grey rect. 29,55 x 59,4
OP075-084-1

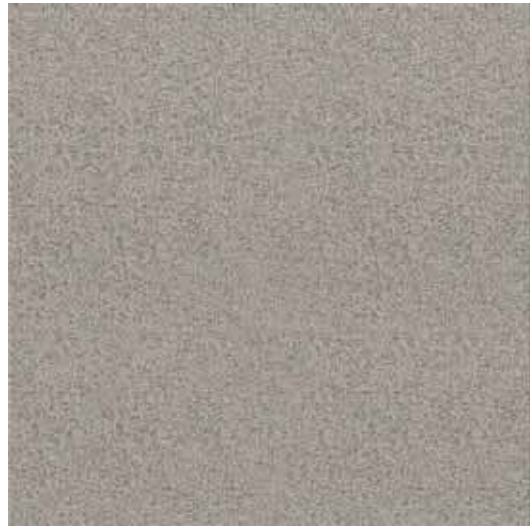

KALLISTO grey 59,8 x 59,8
OP075-072-1
KALLISTO grey polished 59,4 x 59,4
OP075-092-1
KALLISTO grey rect. 59,4 x 59,4
OP075-080-1



KALLISTO graphite skirting
7,2 x 59,4
OP075-101



KALLISTO graphite steptread
29,7 x 59,8
OP075-097-1



KALLISTO graphite 29,7 x 59,8
OP075-077-1
KALLISTO graphite polished 29,55 x 59,4
OP075-089-1
KALLISTO graphite rect. 29,55 x 59,4
OP075-085-1

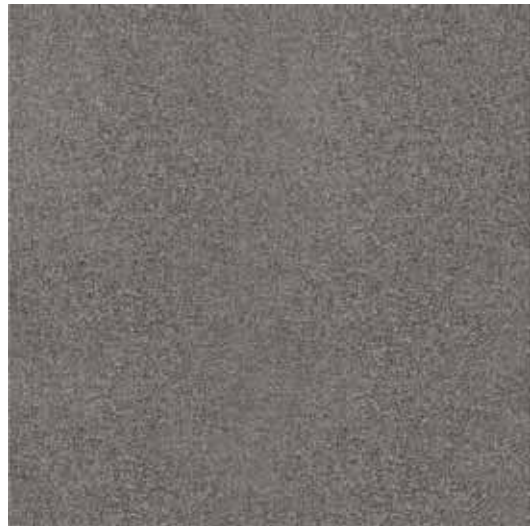

KALLISTO graphite 59,8 x 59,8
OP075-073-1
KALLISTO graphite polished 59,4 x 59,4
OP075-093-1
KALLISTO graphite rect. 59,4 x 59,4
OP075-081-1

cm	cm	pcs	m ²	kg	kg/m ²	m ²	cm	cm	pcs
29,7x59,8	0,85	9	1,6	30,94	19,34	51,2	7,2x59,4	0,85	7
59,8x59,8	1,0	5	1,79	43,25	24,16	35,8			
29,55x59,4	0,85	9	1,58	37,24	23,57	50,56			
29,55x59,4 polished	0,75	9	1,58	35,31	22,35	50,56			
59,4x59,4	1,0	5	1,76	41,25	23,44	35,2			
59,4x59,4 polished	0,9	5	1,76	39,74	22,58	35,2			

* R10 - only matt tiles



frost-resistant tile



R10 non-slip class



KALLISTO K3 cream 29,7 x 29,7
OP075-004-1
KALLISTO K3 cream polished
29,5 x 29,5
OP075-102-1



KALLISTO K4 beige 29,7 x 29,7
OP075-007-1
KALLISTO K4 beige polished
29,5 x 29,5
OP075-103-1



KALLISTO K2 yellow 29,7 x 29,7
OP075-047-1
KALLISTO K2 yellow polished
29,5 x 29,5
OP075-104-1



KALLISTO K6 terracotta 29,7 x 29,7
OP075-011-1
KALLISTO K6 terracotta polished
29,5 x 29,5
OP075-105-1



KALLISTO K3 cream steptread
29,7 x 29,7
OP075-006-1



KALLISTO K4 beige steptread
29,7 x 29,7
OP075-009-1



KALLISTO K2 yellow steptread
29,7 x 29,7
OP075-051-1

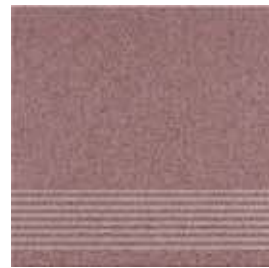

KALLISTO K6 terracotta steptread
29,7 x 29,7
OP075-012-1

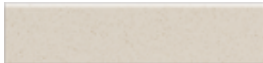

KALLISTO K3 cream skirting
7,2 x 29,7
OD075-026



KALLISTO K4 beige skirting
7,2 x 29,7
OD075-027



KALLISTO K2 yellow skirting
7,2 x 29,7
OD075-049



KALLISTO K6 terracotta skirting
7,2 x 29,7
OD075-028



KALLISTO K5 brown 29,7 x 29,7
OP075-054-1
KALLISTO K5 brown polished
29,5 x 29,5
OP075-106-1



KALLISTO K5 brown steptread
29,7 x 29,7
OP075-055-1



KALLISTO K11 black 29,7 x 29,7
OP075-059-1
KALLISTO K11 black polished
29,5 x 29,5
OP075-107-1



KALLISTO K11 black steptread
29,7 x 29,7
OP075-060-1



KALLISTO K5 brown skirting
7,2 x 29,7
OD075-052



KALLISTO K11 black skirting
7,2 x 29,7
OD075-057

p#
404
405

Kallisto

30x30



KALLISTO K10 graphite 29,7 x 29,7
OP075-001-1
KALLISTO K10 graphite polished
29,5 x 29,5
OP075-108-1



KALLISTO K9 grey 29,7 x 29,7
OP075-019-1
KALLISTO K9 grey polished
29,5 x 29,5
OP075-109-1



KALLISTO K7 green 29,7 x 29,7
OP075-013-1
KALLISTO K7 green polished
29,5 x 29,5
OP075-110-1



KALLISTO K8 blue 29,7 x 29,7
OP075-018-1
KALLISTO K8 blue polished
29,5 x 29,5
OP075-111-1



KALLISTO K10 graphite steptread
29,7 x 29,7
OP075-003-1



KALLISTO K9 grey steptread
29,7 x 29,7
OP075-021-1



KALLISTO K7 green steptread
29,7 x 29,7
OP075-015-1



KALLISTO K8 blue steptread
29,7 x 29,7
OP075-017-1



KALLISTO K10 graphite skirting
7,2 x 29,7
OD075-024



KALLISTO K9 grey skirting
7,2 x 29,7
OD075-031

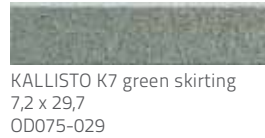

KALLISTO K7 green skirting
7,2 x 29,7
OD075-029



KALLISTO K8 blue skirting
7,2 x 29,7
OD075-030



KALLISTO cream 12mm
20 x 20
OP075-022-1



KALLISTO beige 12mm
20 x 20
OP075-045-1



KALLISTO grey 12mm
20 x 20
OP075-043-1



KALLISTO graphite 12mm
20 x 20
OP075-044-1













KALLISTO cream anti-slip
12mm
20 x 20
OP075-023-1



KALLISTO grey anti-slip
12mm
20 x 20
OP075-046-1



 cm	 cm	 pcs	 m ²	 kg	 kg/m ²	 m ²	 cm	 cm	 pcs
20x20	1,2	15	0,6	15,94	26,57	36	7,2x29,7	0,8	24
29,7x29,7	0,8	15	1,32	23,69	17,95	58,08			
29,5x29,5 polished	0,7	15	1,3	21,75	16,73	57,2			

* R10 - only matt tiles

  non-slip class

 frost-resistant tile



p#
406
407



Hyperion

modern

30x30



HYPERION H3 cream 29,7 x 29,7
OP074-005-1
HYPERION H3 cream polished
29,5 x 29,5
OP074-079-1



HYPERION H4 beige 29,7 x 29,7
OP074-009-1
HYPERION H4 beige polished
29,5 x 29,5
OP074-080-1



HYPERION H2 yellow 29,7 x 29,7
OP074-053-1
HYPERION H2 yellow polished
29,5 x 29,5
OP074-078-1



HYPERION H6 terracotta 29,7 x 29,7
OP074-014-1
HYPERION H6 terracotta polished
29,5 x 29,5
OP074-082-1



HYPERION H3 cream 3d
29,7 x 29,7
OP074-006-1



HYPERION H4 beige 3d
29,7 x 29,7
OP074-010-1



HYPERION H2 yellow 3d
29,7 x 29,7
OP074-056-1



HYPERION H6 terracotta 3d
29,7 x 29,7
OP074-015-1



HYPERION H3 cream skirting
7,2 x 29,7
OD074-030



HYPERION H4 beige skirting
7,2 x 29,7
OD074-031



HYPERION H2 yellow skirting
7,2 x 29,7
OD074-065



HYPERION H6 terracotta skirting
7,2 x 29,7
OD074-032



HYPERION H3 cream steptread
29,7 x 29,7
OP074-008-1



HYPERION H4 beige steptread
29,7 x 29,7
OP074-012-1



HYPERION H2 yellow steptread
29,7 x 29,7
OP074-055-1

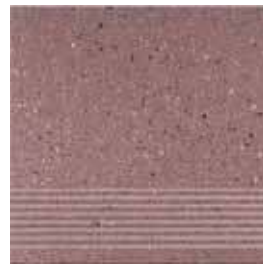

HYPERION H6 terracotta steptread
29,7 x 29,7
OP074-016-1



HYPERION H5 brown 29,7 x 29,7
OP074-057-1
HYPERION H5 brown polished
29,5 x 29,5
OP074-081-1



HYPERION H5 brown skirting
7,2 x 29,7
OD074-066



HYPERION H11 black 29,7 x 29,7
OP074-061-1
HYPERION H11 black polished
29,5 x 29,5
OP074-077-1



HYPERION H11 black skirting
7,2 x 29,7
OD074-067



HYPERION H5 brown 3d
29,7 x 29,7
OP074-060-1



HYPERION H5 brown steptread
29,7 x 29,7
OP074-059-1



HYPERION H11 black 3d
29,7 x 29,7
OP074-064-1



HYPERION H11 black steptread
29,7 x 29,7
OP074-063-1

p#
408
409

Hyperion

30x30



*

HYPERION H10 graphite 29,7 x 29,7
OP074-001-1
HYPERION H10 graphite polished
29,5 x 29,5
OP074-076-1



*

HYPERION H9 grey 29,7 x 29,7
OP074-025-1
HYPERION H9 grey polished
29,5 x 29,5
OP074-085-1

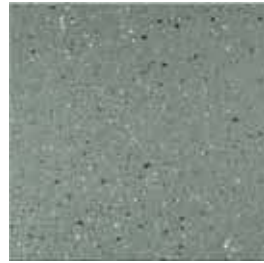

*

HYPERION H7 green 29,7 x 29,7
OP074-017-1
HYPERION H7 green polished
29,5 x 29,5
OP074-083-1



*

HYPERION H8 blue 29,7 x 29,7
OP074-023-1
HYPERION H8 blue polished
29,5 x 29,5
OP074-084-1



HYPERION H10 graphite 3d
29,7 x 29,7
OP074-002-1

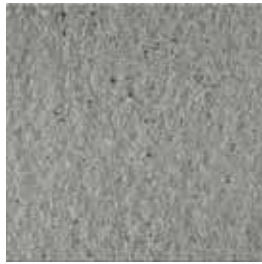

HYPERION H9 grey 3d
29,7 x 29,7
OP074-026-1

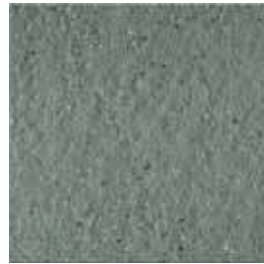

HYPERION H7 green 3d
29,7 x 29,7
OP074-018-1



HYPERION H8 blue 3d
29,7 x 29,7
OP074-024-1



HYPERION H10 graphite skirting
7,2 x 29,7
OD074-029



HYPERION H9 grey skirting
7,2 x 29,7
OD074-035



HYPERION H7 green skirting
7,2 x 29,7
OD074-033



HYPERION H8 blue skirting
7,2 x 29,7
OD074-034



HYPERION H10 graphite steptread
29,7 x 29,7
OP074-004-1



HYPERION H9 grey steptread
29,7 x 29,7
OP074-028-1

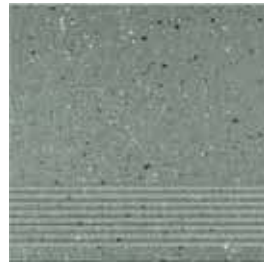

HYPERION H7 green steptread
29,7 x 29,7
OP074-020-1

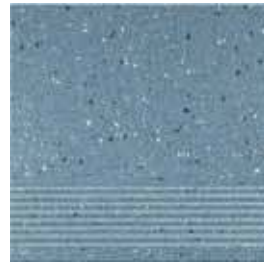

HYPERION H8 blue steptread
29,7 x 29,7
OP074-022-1

29,7x29,7	0,8	15	1,32	23,69	17,95	58,08	7,2x29,7	0,8	24
29,5x29,5 polished	0,7	15	1,3	21,75	16,73	57,2			

* R10 - only matt tiles

non-slip class

frost-resistant tile

p#
410
411

Milton
modern

30x30





MILTON beige
29,7 x 29,7
OP069-001-1



MILTON beige steptread
29,7 x 29,7
OP069-002-1



MILTON yellow
29,7 x 29,7
OP069-013-1



MILTON yellow steptread
29,7 x 29,7
OP069-014-1



MILTON orange
29,7 x 29,7
OP069-009-1



MILTON orange steptread
29,7 x 29,7
OP069-010-1



MILTON brown
29,7 x 29,7
OP069-003-1



MILTON brown steptread
29,7 x 29,7
OP069-004-1

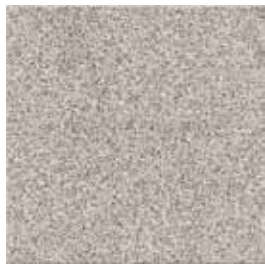

MILTON grey
29,7 x 29,7
OP069-011-1



MILTON grey steptread
29,7 x 29,7
OP069-012-1



MILTON olive
29,7 x 29,7
OP069-007-1

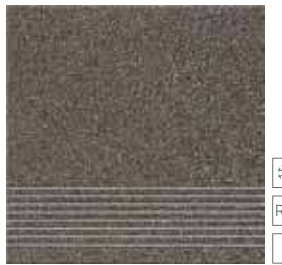

MILTON olive steptread
29,7 x 29,7
OP069-008-1

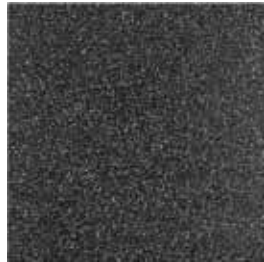

MILTON graphite
29,7 x 29,7
OP069-005-1



MILTON graphite steptread
29,7 x 29,7
OP069-006-1



29,7x29,7	0,8	15	1,32	22,15	16,78	58,08			



p#
412
413



p#
414
415

new

Arkos
classic

45x90



ARKOS cream lappato
44,6 x 89,5
MT005-001-1



ARKOS cream lappato
44,6 x 44,6
MT005-002-1



ARKOS cream mosaic
22,2 x 44,6
MD005-008

p#
416
417



ARKOS cream mosaic classic
22,2 x 44,6
MD005-006



ARKOS cream classic border
9,8x44,6
MD005-010



ARKOS cream corner classic
9,8 x 9,8
MD005-012

new

Arkos
45x90



ARKOS brown lappato
44,6 x 44,6
MT005-004-1



ARKOS brown lappato
44,6 x 89,5
MT005-003-1

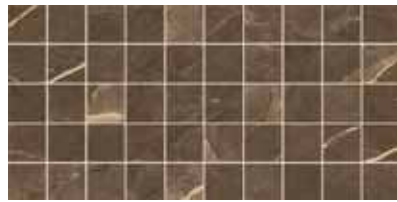

ARKOS brown mosaic
22,2 x 44,6
MD005-007



ARKOS brown mosaic classic
22,2 x 44,6
MD005-005



ARKOS brown classic border
9,8 x 44,6
MD005-009



ARKOS brown corner classic
9,8 x 9,8
MD005-011



cm	cm	pcs	m ²	kg	kg/m ²	m ²	cm	cm	pcs
44,6x89,5	1,1	3	1,2	29,76	24,8	21,6	9,8x44,6	1,1	8
44,6x44,6	1,1	6	1,19	29,51	24,8	23,8	9,8x9,8	1,1	4
22,2x44,6	1,1	8	-	-	-	-			



abrasion-resistance class



non-slip class



frost-resistant tile

p#
418
419



new

Daino
classic

45x90





DAINO cream
44,6 x 89,5
MT001-001-1



DAINO cream
44,6 x 44,6
MT001-002-1



DAINO cream lappato
44,6 x 89,5
MT001-003-1



DAINO cream lappato
44,6 x 44,6
MT001-004-1



DAINO beige mosaic classic
22,2 x 44,6
MD001-016



DAINO cream mosaic
22,2 x 44,6
MD001-017



DAINO cream border classic
7,2 x 89,5
MD001-014



DAINO cream corner classic
7,2 x 7,2
MD001-015



DAINO cream steptread
29,5 x 44,6
MT001-026

new

Daíno
45x90



DAINO beige
44,6 x 89,5
MT001-005-1



DAINO beige
44,6 x 44,6
MT001-007-1



DAINO beige lappato
44,6 x 89,5
MT001-006-1



DAINO beige lappato
44,6 x 44,6
MT001-008-1



DAINO beige mosaic
22,2 x 44,6
MD001-018



DAINO beige steptread
29,5 x 44,6
MT001-027



cm	cm	pcs	m ²	kg	kg/m ²	m ²	cm	cm	pcs
44,6x89,5	1,1	3	1,2	29,76	24,8	21,6	7,2x44,6	1,1	10
44,6x44,6	1,1	6	1,19	29,51	24,8	23,8	7,2x7,2	1,1	4
44,6x89,5 inserto	1,1	3	1,2	29,76	24,8	21,6			
22,2x44,6 mosaic	1,1	8	-	-	-	-			
29,5 x 44,6 steptread	1,1	6	-	-	-	-			



p#
422
423

new

Yakara
classic

45x90





p#
424
425

new

Yakara
45x90



YAKARA white
44,6 x 89,5
MT002-007-1



YAKARA white
44,6 x 44,6
MT002-010-1



YAKARA white lappato
44,6 x 89,5
MT002-004-1



YAKARA white lappato
44,6 x 44,6
MT002-001-1



YAKARA white mosaic
22,2 x 44,6
MD002-014



YAKARA white steptread
29,5 x 44,6
MT002-030



YAKARA grey
44,6 x 89,5
MT002-008-1



YAKARA grey
44,6 x 44,6
MT002-011-1



YAKARA grey lappato
44,6 x 89,5
MT002-005-1



YAKARA grey lappato
44,6 x 44,6
MT002-002-1

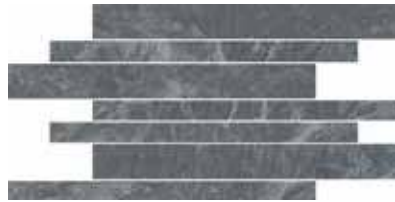

YAKARA grey mosaic
22,2 x 44,6
MD002-015



YAKARA grey steptread
29,5 x 44,6
MT002-031

new

Yakara

45x90



R10
3

YAKARA graphite
44,6 x 89,5
MT002-009-1



R10
3

YAKARA graphite
44,6 x 44,6
MT002-012-1



R9
3

YAKARA graphite lappato
44,6 x 89,5
MT002-006-1



R9
3

YAKARA graphite lappato
44,6 x 44,6
MT002-003-1



3

YAKARA graphite mosaic
22,2 x 44,6
MD002-016



R10
4

YAKARA graphite steptread
29,5 x 44,6
MT002-032



cm	cm	pcs	m ²	kg	kg/m ²	m ²	cm	cm	pcs
44,6x89,5	1,1	3	1,2	29,76	24,8	21,6			
44,6x44,6	1,1	6	1,19	29,51	24,8	23,8			
22,2x44,6 mosaic	1,1	8	-	-	-	-			
29,5 x 44,6 steptread	1,1	6	-	-	-	-			

5 4 3 abrasion-resistance class

R10 R9 non-slip class

 frost-resistant tile

p#
428
429



new

Quartz
classic

45x90





p#
430
431

new

Quartz
45x90



QUARTZ beige
44,6 x 89,5
MT006-001-1



QUARTZ beige mosaic A
22,2 x 44,6
MD006-003



QUARTZ beige mosaic B
22,2 x 44,6
MD006-004



QUARTZ beige steptread
29,5 x 44,6
MT006-006



cm	cm	pcs	m ²	kg	kg/m ²	m ²	cm	cm	pcs
44,6x89,5	1,1	3	1,2	29,76	24,8	21,6			
22,2x44,6 mosaic	1,1	8	-	-	-	-			
29,5 x 44,6 steptread	1,1	6	-	-	-	-			



p#
432
433

new

Playa
classic

45x90



p#
434
435

new

Playa
45x90



PLAYA cream lappato
44,6 x 89,5
MT003-001-1



PLAYA cream lappato
44,6 x 44,6
MT003-002-1



PLAYA cream border line
22,2 x 44,6
MD003-007

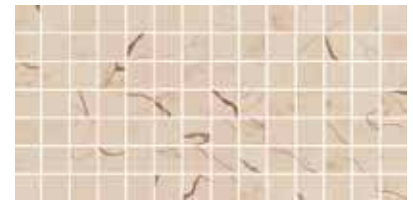

PLAYA cream mosaic
22,2 x 44,6
MD003-003



PLAYA cream border
9,4x44,6
MD003-008



PLAYA cream border
9,4x9,4
MD003-006



cm	cm	pcs	m ²	kg	kg/m ²	m ²	cm	cm	pcs
44,6x89,5	1,1	3	1,2	29,76	24,8	21,6	9,4x44,6	1,1	8
44,6x44,6	1,1	6	1,19	29,51	24,8	23,8	9,4x9,4	1,1	4
22,2x89,5	1,1	4	-	-	-	-			
22,2x44,6 mosaic	1,1	8	-	-	-	-			



abrasion-resistance class



non-slip class



frost-resistant tile

p#
436
437



new

Legno Rustico
classic

15x90





p#
438
439

new

Legno Rustico

15x90



LEGNO RUSTICO cream
14,7x89,5
MT004-001-1



LEGNO RUSTICO beige
14,7x89,5
MT004-002-1



LEGNO RUSTICO brown
14,7x89,5
MT004-003-1



LEGNO RUSTICO grey
14,7x89,5
MT004-004-1



cm	cm	pcs	m ²	kg	kg/m ²	m ²	cm	cm	pcs
14,7 x 89,5	1,1	8	1,05	26,04	24,8	16,8			



abrasion-resistance class



non-slip class



frost-resistant tile



p#
440
441



Carrara
classic

60x60

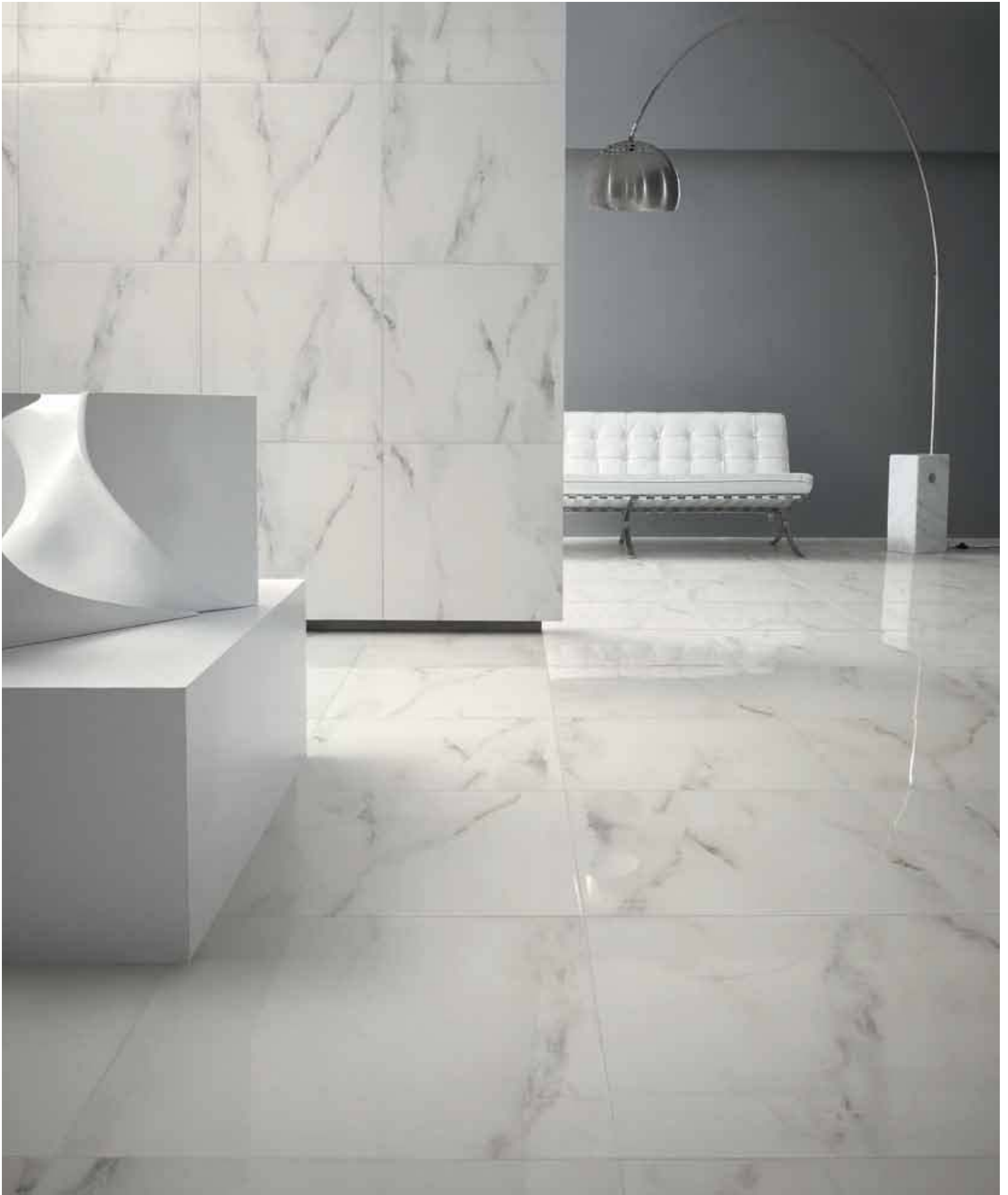

p#
442
443

Carrara
60x60



CARRARA
59,3 x 59,3
OP001-001-1



CARRARA polished
59,3 x 59,3
OP001-002-1



glossy tiles



matt tiles



rectified tiles

cm	cm	pcs	m ²	kg	kg/m ²	m ²	cm	cm	pcs
59,3x59,3	1	5	1,76	42,5	24,15	35,2			



abrasion-resistance class



frost-resistant tile



p#
444
445



Lazio
classic

60x60



p#
446
447

Lazio
60x60



LAZIO white
59,3 x 59,3
OP004-003-1



LAZIO white polished
59,3 x 59,3
OP004-004-1



LAZIO beige
59,3 x 59,3
OP004-001-1



LAZIO beige polished
59,3 x 59,3
OP004-002-1



glossy tiles



matt tiles



rectified tiles

cm	cm	pcs	m ²	kg	kg/m ²	m ²	cm	cm	pcs
59,3x59,3	1	5	1,76	42,5	24,15	35,2			



p#
448
449



Sahara
classic

60x60



p#
450
451

Sahara
60x60



SAHARA beige lappato
59,3 x 59,3
OP358-001-1



SAHARA beige lappato
29 x 59,3
OP358-002-1



SAHARA beige border
8,7 x 59,3
OD358-005



glossy tiles



rectified tiles

cm	cm	pcs	m ²	kg	kg/m ²	m ²	cm	cm	pcs
59,3x59,3	1,0	5	1,76	41,5	23,58	35,2	8,7x59,3	1,0	10
29x59,3	1,0	7	1,2	28	23,33	38,4			



abrasion-resistance class



non-slip class



frost-resistant tile



p#
452
453

A photograph of an outdoor furniture set on a balcony. The set includes a dark wicker chair with a white cushion, a round glass table with a black metal frame, and a white teacup and saucer. The balcony has a white wall and a view of the sea and a cloudy sky. A semi-transparent white box is overlaid on the image, containing the text 'Spazio classic' and '60x60'.

Spazio
classic

60x60



SPAZIO cream
29 x 59,3
OP054-005-1



SPAZIO cream lappato
29 x 59,3
OP054-007-1



SPAZIO beige
29 x 59,3
OP054-006-1



SPAZIO beige lappato
29 x 59,3
OP054-008-1

p#
454
455

Spazio
60x60



SPAZIO cream
59,3 x 59,3
OP054-001-1



SPAZIO cream lappato
59,3 x 59,3
OP054-003-1



SPAZIO beige
59,3 x 59,3
OP054-002-1



SPAZIO beige lappato
59,3 x 59,3
OP054-004-1



glossy tiles



matt tiles



rectified tiles

cm	cm	pcs	m ²	kg	kg/m ²	m ²	cm	cm	pcs
59,3x59,3	1	5	1,76	42,5	24,15	35,2			
29x59,3	1	7	1,2	28,0	23,33	38,4			

4 abrasion-resistance class

R10 non-slip class

☼ frost-resistant tile



p#
456
457



Naturale
classic

30x60



NATURALE cream
29,7 x 59,8
OP012-009-1



NATURALE beige
29,7 x 59,8
OP012-003-1



NATURALE cream
14,8 x 59,8
OP012-007-1



NATURALE beige
14,8 x 59,8
OP012-001-1



NATURALE orange
29,7 x 59,8
OP012-012-1



NATURALE brown
29,7 x 59,8
OP012-006-1



NATURALE orange
14,8 x 59,8
OP012-010-1



NATURALE brown
14,8 x 59,8
OP012-004-1



p#
458
459

Naturale
30x60



NATURALE orange mosaic
29,7 x 29,7
OD012-023



NATURALE brown mosaic
29,7 x 29,7
OD012-022



NATURALE cream
29,7 x 29,7
OP012-008-1



NATURALE beige
29,7 x 29,7
OP012-002-1



NATURALE orange
29,7 x 29,7
OP012-011-1



NATURALE brown
29,7 x 29,7
OP012-005-1



NATURALE beige border mosaic
5,4 x 29,7
OD012-015



matt tiles



structured tiles

cm	cm	pcs	m ²	kg	kg/m ²	m ²	cm	cm	pcs
29,7x59,8	0,85	9	1,6	30,5	19,06	51,2	14,8x59,8	0,85	10
14,8x59,8	0,85	10	0,89	16,87	19,06	31,86	5,4x 29,7	0,8	5
29,7x29,7 mosaic	0,8	15	-	-	-	-			
29,7x29,7	0,8	15	1,32	22,15	16,78	58,08			

4

3

abrasion-resistance class

R9

non-slip class



frost-resistant tile



p#
460
461



Nodo
classic

30x60



p#
462
463

Nodo
30x60



NODO cream
29,7 x 59,8
OP057-001-1



NODO beige
29,7 x 59,8
OP057-002-1



NODO grey rustic
29,7 x 59,8
OP057-005-1



NODO brown
29,7 x 59,8
OP057-003-1



glossy tiles



structured tiles

cm	cm	pcs	m ²	kg	kg/m ²	m ²	cm	cm	pcs
29,7x59,8	0,85	9	1,6	30,5	19,06	51,2			



abrasion-resistance class



non-slip class



frost-resistant tile



p#
464
465



Misty Stone
classic

45x45



p#
466
467

Misty Stone
45x45



MISTY STONE beige
45 x 45
OP619-001-1



MISTY STONE beige border
45 x 45
OP619-002-1



MISTY STONE beige corner
45 x 45
OP619-003-1



cm	cm	pcs	m ²	kg	kg/m ²	m ²	cm	cm	pcs
45x45	0,9	8	1,62	29,86	18,43	35,64			



abrasion-resistance class



frost-resistant tile

p#
468
469



A photograph of a balcony or terrace. In the foreground, a wicker chair with a curved, ergonomic design is positioned on a grey tiled floor. The chair is made of a light brown, woven material. Behind the chair is a black wrought-iron railing with decorative scrollwork. In the background, there is a white wall with a window that has a wooden frame and a glass pane. To the left, a wooden door with a glass pane is visible. The overall scene is brightly lit, suggesting daytime.

Mojave
classic

40x40



p#
470
471

Mojave
40x40



MOJAVE cream
39,6 x 39,6
OP356-001-1



MOJAVE beige
39,6 x 39,6
OP356-002-1



MOJAVE brown
39,6 x 39,6
OP356-003-1



MOJAVE grey
39,6 x 39,6
OP356-004-1



MOJAVE border mosaic
9,7 x 39,6
OD356-005



matt tiles

cm	cm	pcs	m ²	kg	kg/m ²	m ²	cm	cm	pcs
39,6x39,6	0,85	9	1,41	26,83	19,03	36,66	9,7x39,6 mosaic	0,85	24



abrasion-resistance class



non-slip class



frost-resistant tile



p#
472
473



p#
474
475



Solar
clinker

30x30



R10

3

SOLAR brown 3d
30 x 30
OP128-007-1



R10

3

SOLAR brown steptread 3d
30 x 30
OP128-010-1



R10

3

SOLAR brown steptread corner 3d
30 x 30
OP128-011-1



3

SOLAR brown under stair 3d
14,8 x 30
OP128-009-1



3

SOLAR brown border
14,8 x 30
OD128-022-1



3

SOLAR brown corner
14,8 x 14,8
OD128-025-1



solar brown elevation 3d
6,5 x 24,5
OP128-008-1



SOLAR brown skirting right 3d
8,1 x 30
OD128-002-1



SOLAR brown skirting left 3d
8,1 x 30
OD128-001-1



SOLAR brown skirting 3d
8 x 30
OD128-028-1



R10

3

SOLAR brown kapinos stright 3d
30 x 33
OD128-033-1



R10

3

SOLAR brown kapinos corner 3d
33 x 33
OD128-029-1



SOLAR brown sill A
14,8 x 30
OD128-030-1



SOLAR brown sill B
13,5 x 24,5
OD128-031-1



SOLAR brown sill C
10 x 20
OD128-032-1

p#
476
477

Solar

30x30



R10
3

SOLAR graphite 3d
30 x 30
OP128-012-1



R10
3

SOLAR graphite steptread 3d
30 x 30
OP128-015-1



R10
3

SOLAR graphite steptread corner 3d
30 x 30
OP128-016-1



3

SOLAR graphite under stair 3d
14,8 x 30
OP128-014-1



3

SOLAR graphite border
14,8 x 30
OD128-023-1



3

SOLAR graphite corner
14,8 x 14,8
OD128-026-1



SOLAR graphite elevation 3d
6,5 x 24,5
OP128-013-1



SOLAR graphite skirting right 3d
8,1 x 30
OD128-004-1



SOLAR graphite skirting left 3d
8,1 x 30
OD128-003-1



SOLAR graphite skirting 3d
8 x 30
OD128-034-1



R10
3

SOLAR graphite kapinos stright 3d
30 x 33
OD128-039-1



R10
3

SOLAR graphite kapinos corner 3d
33 x 33
OD128-035-1



SOLAR graphite sill A
14,8 x 30
OD128-036-1



SOLAR graphite sill B
13,5 x 24,5
OD128-037-1



SOLAR graphite sill C
10 x 20
OD128-038-1



R10

4

SOLAR orange 3d
30 x 30
OP128-017-1



R10

4

SOLAR orange steptread 3d
30 x 30
OP128-020-1



R10

4

SOLAR orange steptread corner 3d
30 x 30
OP128-021-1



4

SOLAR orange under stair 3d
14,8 x 30
OP128-019-1



4

SOLAR orange border
14,8 x 30
OD128-024-1



4

SOLAR orange corner
14,8 x 14,8
OD128-027-1



SOLAR orange elevation 3d
6,5 x 24,5
OP128-018-1



SOLAR orange skirting right 3d
8,1 x 30
OD128-006-1



SOLAR orange skirting left 3d
8,1 x 30
OD128-005-1



SOLAR orange skirting 3d
8 x 30
OD128-040-1



R10

4

SOLAR orange kapinos stright 3d
30 x 33
OD128-045-1



R10

4

SOLAR orange kapinos corner 3d
33 x 33
OD128-041-1



SOLAR orange sill A
14,8 x 30
OD128-042-1



SOLAR orange sill B
13,5 x 24,5
OD128-043-1







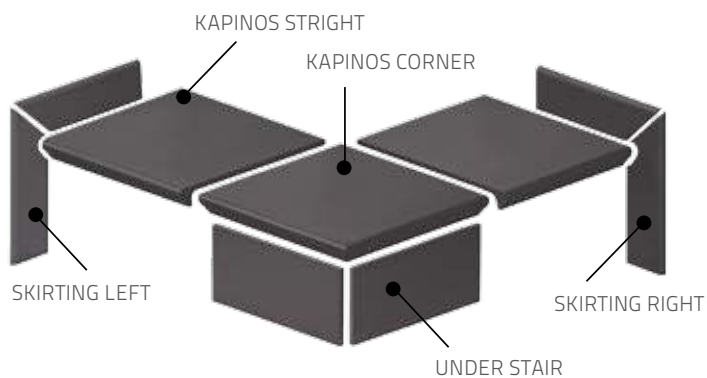
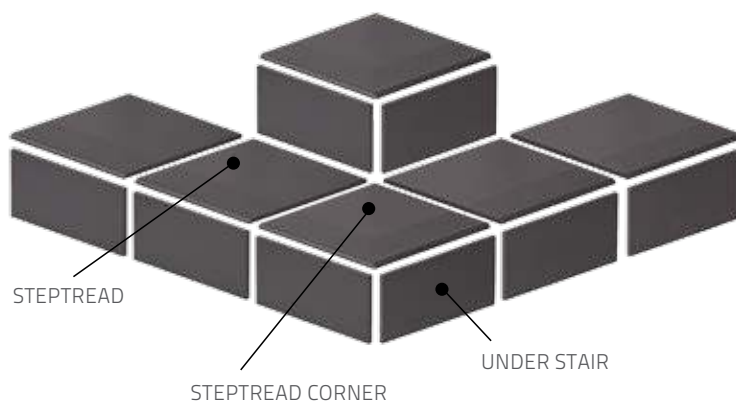

SOLAR orange sill C
10 x 20
OD128-044-1

p#
478
479

Solar
30x30



clinker

 cm	 cm	 pcs	 m ²	 kg	 kg/m ²	 m ²
30x30	1,1	11	0,99	24,8	25,05	39,6
30x33 kapinos stright	1,1	6	-	-	-	-
33x33 kapinos corner	1,1	2	-	-	-	-
30x30 steptread	1,1	10	0,9	22,55	25,05	36
24,5x6,5 elevation	0,74	63	1	16	16	63
30x14,8 under stair	1,1	22	0,98	24,31	24,81	39,2
30x8 skirting	1,1	42	-	-	-	-
30x8 skirting (left, right)	1,1	10	-	-	-	-
30x14,8 still A	1,1	22	-	-	-	-
24,5x13,5 still B	1,1	20	-	-	-	-
20x10 still C	1,1	34	-	-	-	-

p#
480
481





Simple
clinker

30x30

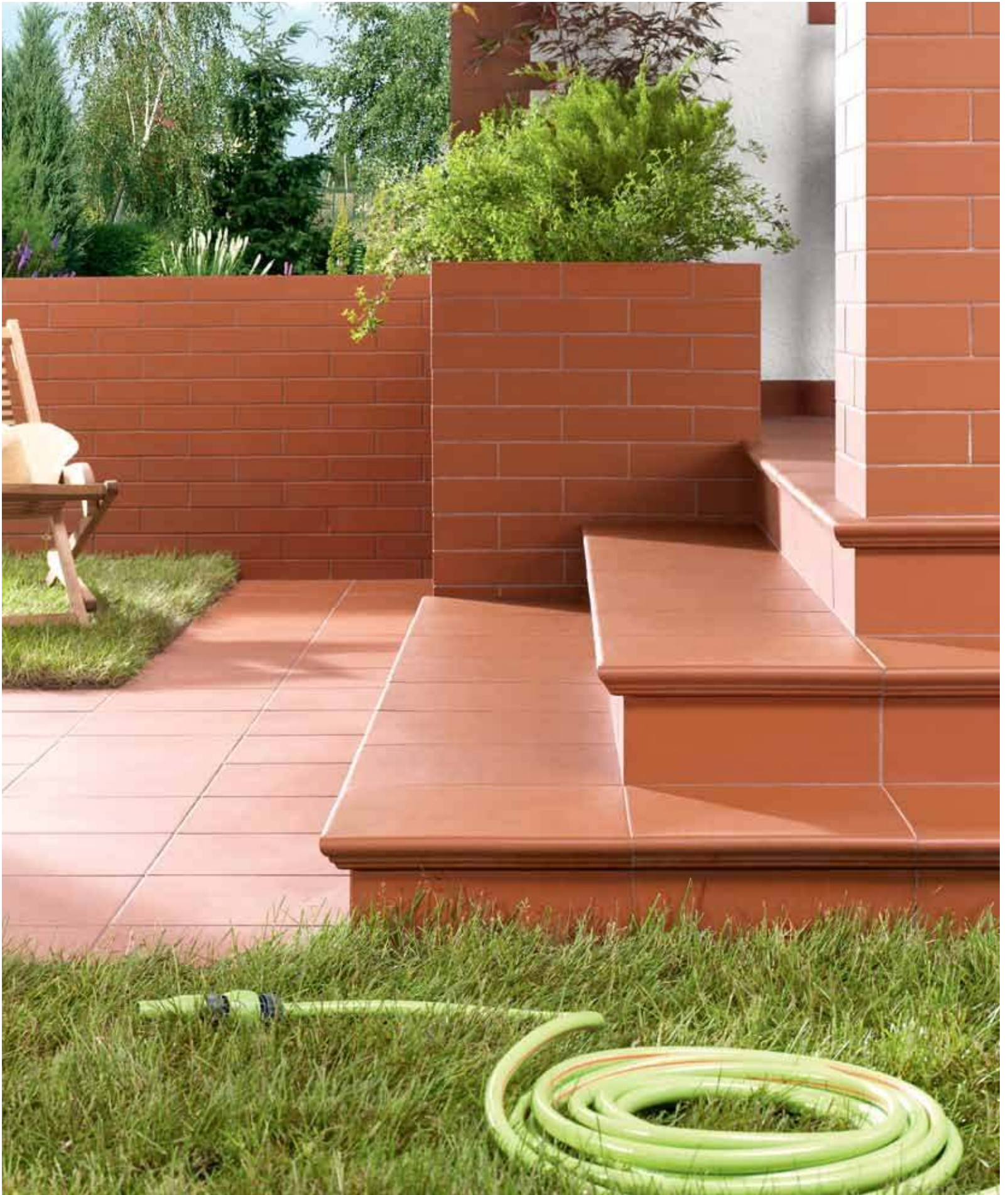

p#
482
483

Simple
30x30



SIMPLE red
30 x 30
OP078-011-1

R9



SIMPLE red 3d
30 x 30
OP078-012-1

R10



SIMPLE red steptread 3d
30 x 30
OP078-018-1

R10



SIMPLE red elevation
6,5 x 24,5
OP078-013-1



SIMPLE red skirting
8 x 30
OD078-041-1



SIMPLE red steptread
30 x 30
OP078-017-1

R9



SIMPLE red steptread corner
30 x 30
OP078-020-1

R9



SIMPLE red steptread corner 3d
30 x 30
OP078-021-1

R10



SIMPLE red elevation 3d
6,5 x 24,5
OP078-014-1



SIMPLE red skirting 3d
8 x 30
OD078-042-1



SIMPLE red skirting right
8 x 30
OD078-065-1



SIMPLE red skirting left
8 x 30
OD078-063-1



SIMPLE red skirting right 3d
8 x 30
OD078-066-1



SIMPLE red skirting left 3d
8 x 30
OD078-064-1



SIMPLE red kapinos stright
30 x 33
OD078-048-1

R9



SIMPLE red kapinos corner
33 x 33
OD078-043-1

R9



SIMPLE red kapinos stright 3d
30 x 33
OD078-049-1

R10



SIMPLE red kapinos corner 3d
33 x 33
OD078-044-1

R10



SIMPLE red sill A
14,8 x 30
OD078-045-1



SIMPLE red sill B
13,5 x 24,5
OD078-046-1



SIMPLE red sill C
10 x 20
OD078-047-1



SIMPLE red under stair
14,8 x 30
OP078-015-1



SIMPLE red under stair 3d
14,8 x 30
OP078-016-1



R9

SIMPLE brown
30 x 30
OP078-001-1



R10

SIMPLE brown 3d
30 x 30
OP078-002-1

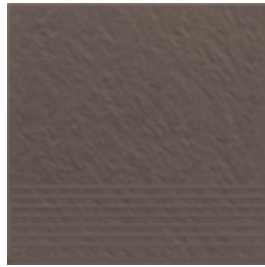

R10

SIMPLE brown steptread 3d
30 x 30
OP078-008-1



SIMPLE brown elevation
6,5 x 24,5
OP078-003-1



SIMPLE brown skirting
8 x 30
OD078-032-1



R9

SIMPLE brown steptread
30 x 30
OP078-007-1



R9

SIMPLE brown steptread corner
30 x 30
OP078-009-1



R10

SIMPLE brown steptread corner 3d
30 x 30
OP078-010-1



SIMPLE brown elevation 3d
6,5 x 24,5
OP078-004-1



SIMPLE brown skirting 3d
8 x 30
OD078-033-1



SIMPLE brown skirting right
8 x 30
OD078-061-1



SIMPLE brown skirting left
8 x 30
OD078-059-1



SIMPLE brown skirting right 3d
8 x 30
OD078-062-1



SIMPLE brown skirting left 3d
8 x 30
OD078-060-1



R9

SIMPLE brown kapinos stright
30 x 33
OD078-039-1



R9

SIMPLE brown kapinos corner
33 x 33
OD078-034-1



R10

SIMPLE brown kapinos stright 3d
30 x 33
OD078-040-1



R10

SIMPLE brown kapinos corner 3d
33 x 33
OD078-035-1



SIMPLE brown sill A
14,8 x 30
OD078-036-1



SIMPLE brown sill B
13,5 x 24,5
OD078-037-1



SIMPLE brown sill C
10 x 20
OD078-038-1

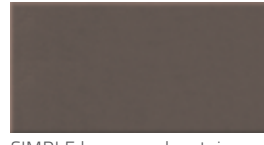

SIMPLE brown under stair
14,8 x 30
OP078-005-1







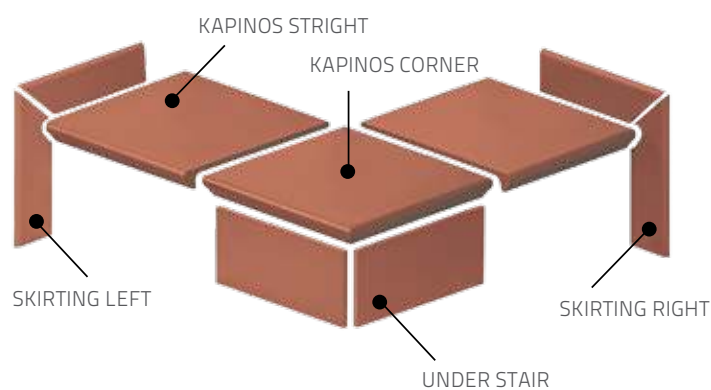
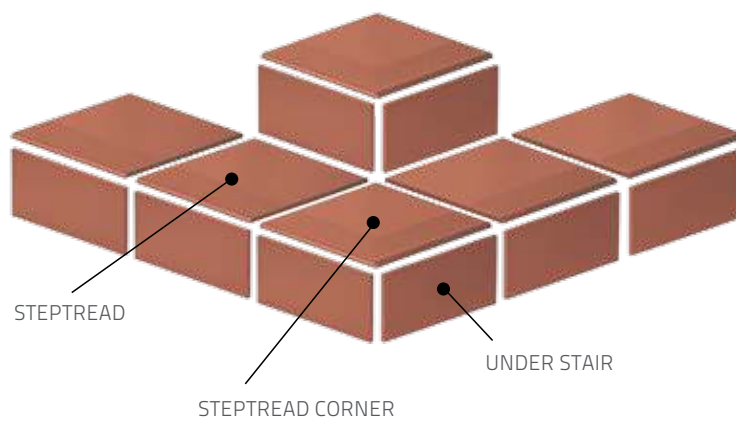

SIMPLE brown under stair 3d
14,8 x 30
OP078-006-1

p#
484
485

Simple
30x30



clinker

 cm	 cm	 pcs	 m ²	 kg	 kg/m ²	 m ²
30x30	1,1	11	0,99	24,8	25,05	39,6
30x33 kapinos stright	1,1	6	-	-	-	-
33x33 kapinos corner	1,1	2	-	-	-	-
30x30 steptread	1,1	10	0,9	22,55	25,05	36
24,5x6,5 elevation	0,74	63	1	16	16	63
30x14,8 under stair	1,1	22	0,98	24,31	24,81	39,2
30x8 skirting	1,1	42	-	-	-	-
30x8 skirting (left, right)	1,1	10	-	-	-	-
30x14,8 still A	1,1	22	-	-	-	-
24,5x13,5 still B	1,1	20	-	-	-	-
20x10 still C	1,1	34	-	-	-	-



p#
486
487

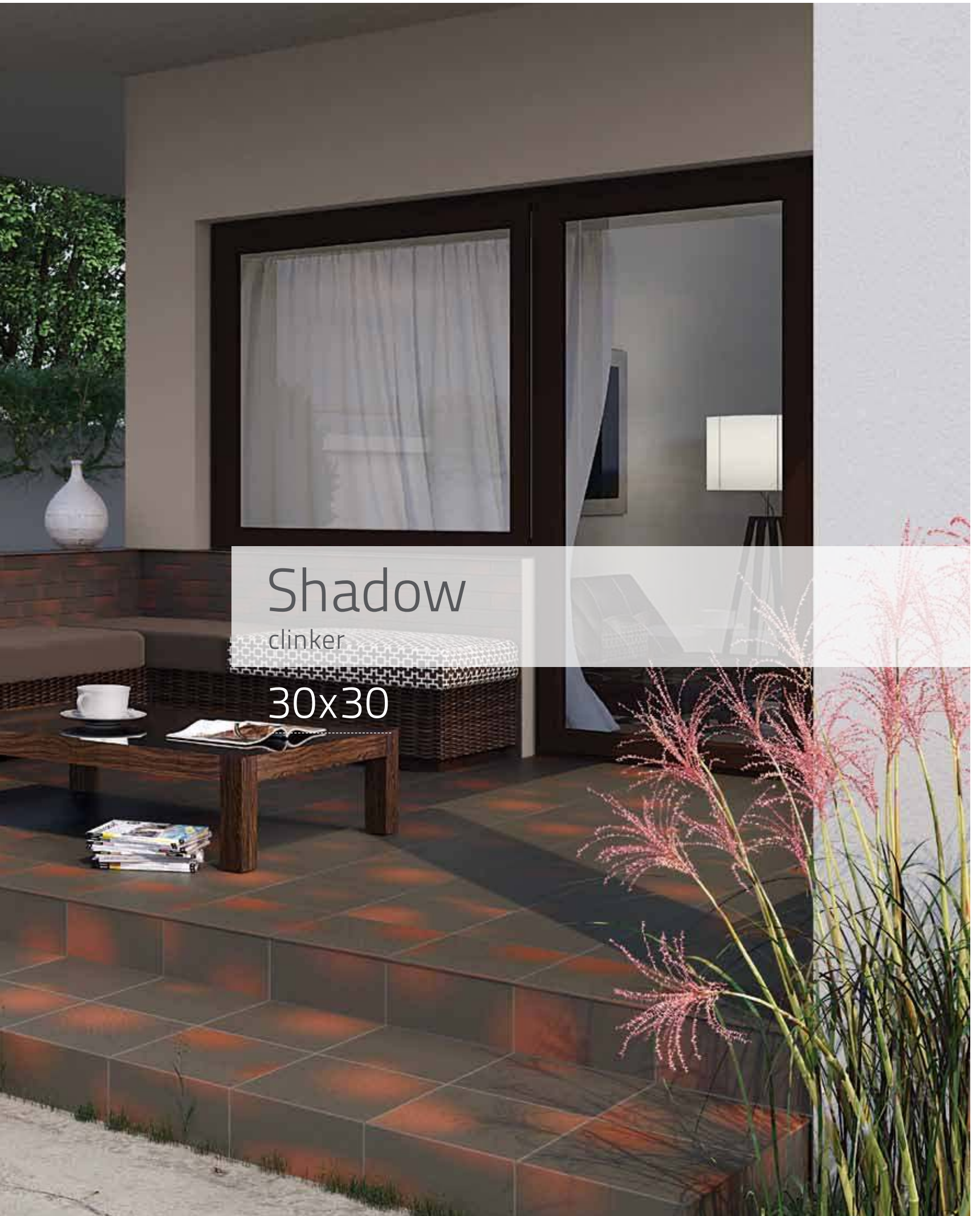

Shadow

clinker

30x30

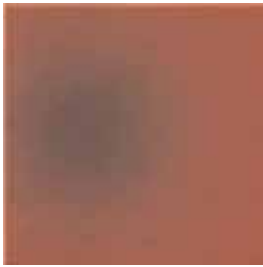

R9

SHADOW red
30 x 30
OP077-011-1



R10

SHADOW red 3d
30 x 30
OP077-012-1

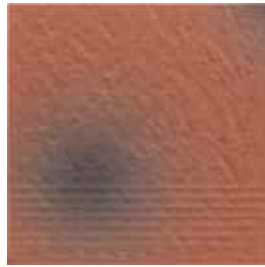

R10

SHADOW red steptread 3d
30 x 30
OP077-018-1



SHADOW red elevation
6,5 x 24,5
OP077-013-1



SHADOW red skirting
8,1 x 30
OD077-030-1



R9

SHADOW red steptread
30 x 30
OP077-017-1

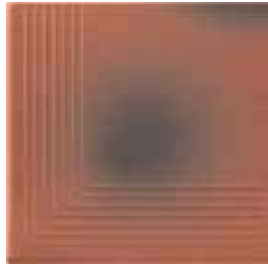

R9

SHADOW red steptread corner
30 x 30
OP077-019-1

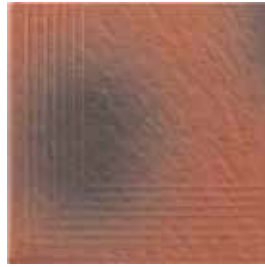

R10

SHADOW red steptread corner 3d
30 x 30
OP077-020-1



SHADOW red elevation 3d
6,5 x 24,5
OP077-014-1



SHADOW red skirting 3d
8,1 x 30
OD077-031-1



SHADOW red skirting right
8,1 x 30
OD077-045-1



SHADOW red skirting left
8,1 x 30
OD077-043-1



SHADOW red skirting right 3d
8,1 x 30
OD077-046-1



SHADOW red skirting left 3d
8,1 x 30
OD077-044-1



R9

SHADOW red kapinos straight
30 x 33
OD077-037-1



R9

SHADOW red kapinos corner
33 x 33
OD077-032-1



R10

SHADOW red kapinos straight 3d
30 x 33
OD077-038-1



R10

SHADOW red kapinos corner 3d
33 x 33
OD077-033-1



SHADOW red sill A
14,8 x 30
OD077-034-1



SHADOW red sill B
13,5 x 24,5
OD077-035-1



SHADOW red sill C
10 x 20
OD077-036-1



SHADOW red under stair
14,8 x 30
OP077-015-1



SHADOW red under stair 3d
14,8 x 30
OP077-016-1

p#
488
489

Shadow

30x30



SHADOW brown
30 x 30
OP077-001-1

R9



SHADOW brown 3d
30 x 30
OP077-002-1

R10



SHADOW brown steptread 3d
30 x 30
OP077-008-1

R10



SHADOW brown elevation
6,5 x 24,5
OP077-003-1

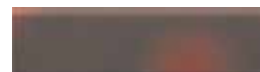

SHADOW brown skirting
8,1 x 30
OD077-021-1

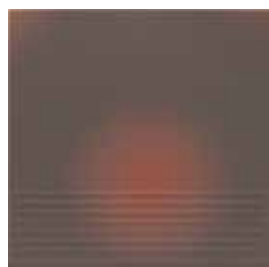

SHADOW brown steptread
30 x 30
OP077-007-1

R9



SHADOW brown steptread corner
30 x 30
OP077-009-1

R9



SHADOW brown steptread corner 3d
30 x 30
OP077-010-1

R10



SHADOW brown elevation 3d
6,5 x 24,5
OP077-004-1



SHADOW brown skirting 3d
8,1 x 30
OD077-022-1



SHADOW brown skirting right
8,1 x 30
OD077-041-1

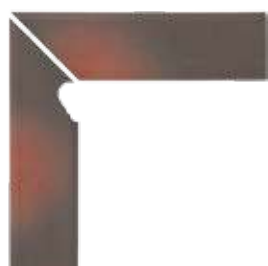

SHADOW brown skirting left
8,1 x 30
OD077-039-1



SHADOW brown skirting right 3d
8,1 x 30
OD077-042-1



SHADOW brown skirting left 3d
8,1 x 30
OD077-040-1



SHADOW brown kapinos straight
30 x 33
OD077-028-1

R9



SHADOW brown kapinos corner
33 x 33
OD077-023-1

R9



SHADOW brown kapinos straight 3d
30 x 33
OD077-029-1

R10



SHADOW brown kapinos corner 3d
33 x 33
OD077-024-1

R10



SHADOW brown sill A
14,8 x 30
OD077-025-1



SHADOW brown sill B
13,5 x 24,5
OD077-026-1



SHADOW brown sill C
10 x 20
OD077-027-1



SHADOW brown under stair
14,8 x 30
OP077-005-1



SHADOW brown under stair 3d
14,8 x 30
OP077-006-1

CERAMIKA
MEBLE
WANNY

CERAMICS
FURNITURE
BATHTUBS

POZNAJ ZALETY NASZYCH PRODUKTÓW

FEATURES AND BENEFITS OF OUR PRODUCTS



CERAMIKA ŁAZIENKOWA

- Przytulny klimat stworzony w łazience dzięki ciepłemu, naturalnemu odcieniowi bieli wszystkich produktów ceramiki łazienkowej Opoczno
- Zmniejszone osadzanie się kamienia dzięki powłoce Perfect Clean, niwelującej porowatość powierzchni
- Wyższy poziom higieny wynikający z bakteriobójczego działania jonów srebra obecnych w deskach sedesowych Opoczno

BATHROOM CERAMICS

- The naturally warm white hue of Opoczno ceramic tiles will make your bathroom a cosy haven
- Perfect Clean coating makes the surfaces extra smooth and prevents limescale build-up
- Opoczno toilet seats contain silver ions whose bactericidal properties provide extra protection from germs



MEBLE

- Dłuższa trwałość produktów zagwarantowana materiałami wysokiej jakości oraz zabezpieczeniem powierzchni mebli lakierem o podwyższonej odporności na ścieranie
- Podwójna wodoodporna ochrona dzięki zastosowaniu wilgocioodpornych płyt oraz zabezpieczeniu wodoodpornym lakierem
- Wieloletnie, bezawaryjne działanie wynikające z wykorzystania najwyższej jakości okuć oraz systemów montażu i mocowań elementów
- Większy komfort użytkowania zapewniony systemami samodomykających się szuflad

FURNITURE

- Our furniture is made from high quality materials and the surfaces are coated with abrasion-resistant varnishes, which guarantees high durability of our products
- Dual waterproof protection is ensured by moisture-resistant boards and waterproof varnishes
- We use highest quality fittings and mounting, systems which guarantee many years of flawless use
- Self closing drawer slides provide extra convenience



WANNY

- Ciepły odcień bieli idealnie dopasowany do kolorystyki ceramiki łazienkowej Opoczno
- Większa odporność wanny na uszkodzenia oraz dłuższe utrzymywanie temperatury wody dzięki grubszej warstwie akrylu

BATHTUBS

- Warm white hue will make your bathtub a perfect match for Opoczno bathroom tiles
- Thicker acrylic layer guarantees that your bathtub will be more resistant to damage and can better retain the desired water temperature

PERFECT CLEAN

PERFEKCYJNA CZYSTOŚĆ

INNOWACYJNA POWŁOKA FLUOROPOLIMEROWA

INNOVATIVE FLUOROPOLYMER COATING

Standardowa powierzchnia ceramiki tylko z pozoru jest idealnie gładka. Pod mikroskopem widoczna jest porowata powierzchnia z mnóstwem zagłębień. Substancje mineralne zawarte w wodzie osadzają się w zagłębieniach powierzchni tworząc trudny do usunięcia osad. Aplikowana w procesie produkcji powłoka **PERFECT CLEAN** niweluje porowatość powierzchni, nie dając szansy osadom. Zmniejsza również energię powierzchniową, przez co odpycha wodę, która w formie drobnych kropelek sływa swobodnie po powierzchni nie pozostawiając osadu.

Standard surfaces of ceramic tiles may seem perfectly smooth. When viewed under a microscope, however, the surface of tiles proves to be porous. Mineral substances present in water build up on the surface of tiles, leaving deposits that are hard to remove. **PERFECT CLEAN**, a coating applied to tiles in the manufacturing process, eliminates surface porosity and prevents the buildup of deposits. By reducing surface energy, it repels water, causing it to roll down the surface of tiles in small drops without leaving residue.



Ceramika typowa
Typical ceramics



Ceramika Opczno
Opczno ceramics

PERFECT CLEAN

GŁADKA POWIERZCHNIA
bez porowatości, w których
pozostaje osad
ODPYCHANIE WODY
drobne krople wody
„staczają się”
z powierzchni

SMOOTH SURFACE
no pores and no residue
WATER REPELLENCE
small drops of water roll down
the surface of tiles

p#
494
495



Bilbao

ceramika, meble, wanny / ceramics, furniture, bathtubs





OK-03-003
 Umywalka BILBAO 70
 z otworem na armaturę, montaż na blacie lub szafce.
 Rozmiar: szerokość 71; wysokość 18; głębokość 45/
 BILBAO 70 washbasin
 with hole for mixer, assembly on walls or on a countertop.
 width 71; height 18; depth 45

OK-03-004
 Umywalka BILBAO 90
 z otworem na armaturę, montaż na blacie lub szafce.
 Rozmiar: szerokość 91; wysokość 18; głębokość 45,5/
 BILBAO 90 washbasin
 with hole for mixer, assembly on walls or on a countertop.
 width 91; height 18; depth 45,5

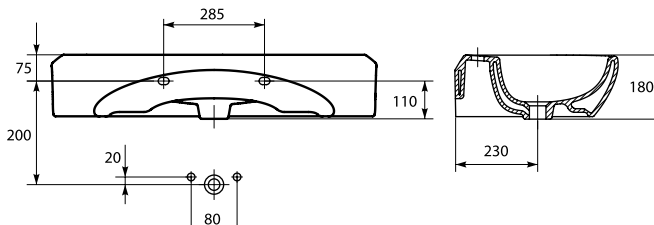
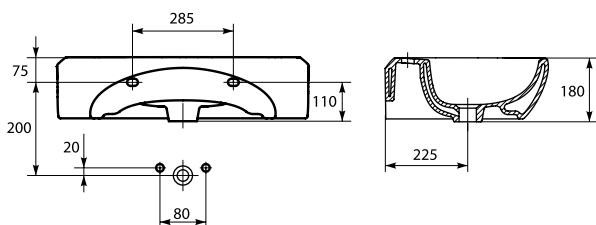
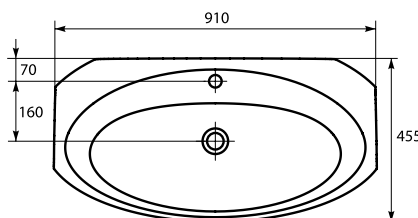
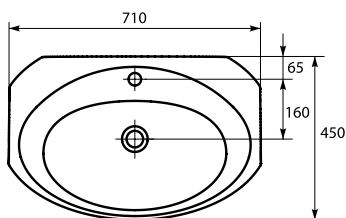

p#
 496
 497

Bilbao



OK-03-002
Miska zawieszana BILBAO
Rozmiar: szerokość 40; wysokość 37; głębokość 57/
BILBAO wall hung bowl
width 40; height 37; depth 57

OK-03-001
Bidet zawieszany BILBAO
Rozmiar: szerokość 40,5; wysokość 34,5; głębokość 56/
BILBAO wall hung bidet
width 40,5; height 34,5; depth 56

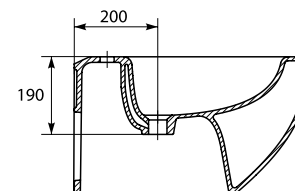
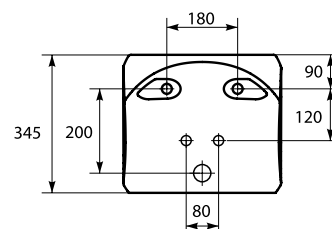
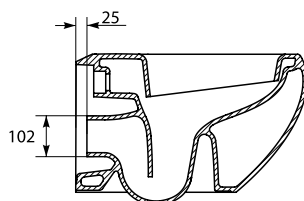
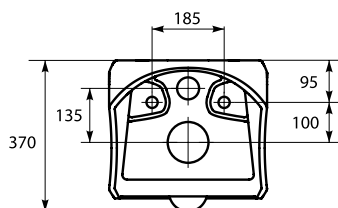
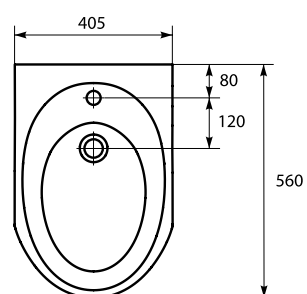
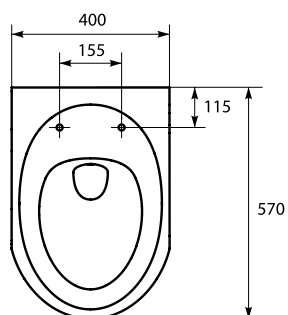

	waga produktu netto/ net product weight	ilość sztuk na paletcie/ number of items on a pallet	waga palety brutto/ gross pallet weight
Umywalka BILBAO 70/BILBAO 70 washbasin	17,10	10	212
Umywalka BILBAO 90/BILBAO 90 washbasin	20,60	5	145
Bidet zawieszany BILBAO/BILBAO wall hung bidet	22,40	12	318
Miska zawieszana BILBAO/BILBAO wall hung bowl	30,40	12	414



p#
498
499

Bilbao



OS-502-002
Słupek KIOTO prawy/lewy
Rozmiar: szerokość 35; wysokość 139; głębokość 30/
KIOTO wall hung tall cabinet right/left
width 35; height 139; depth 30



OS-502-003
Lustro KIOTO 130 z oświetleniem
Rozmiar: szerokość 130; wysokość 55; głębokość 8/
KIOTO mirror 130 with light
width 130; height 55; depth 8



OS-502-001
Szafka KIOTO pod umywalki BILBAO 70, 90
Rozmiar: szerokość 130; wysokość 40; głębokość 42/
KIOTO cabinet for BILBAO washbasins 70, 90
width 130; height 40; depth 42



OS-502-004 wenge/wenge, OS-502-005 czerwony/red,
OS-502-006 czarny/black, OS-502-007 biały/white
Kontener z szufladami/
Rozmiar: szerokość 62; wysokość 28,3; głębokość 40/
KIOTO wall hung mobile cabinet
width 62; height 28,3; depth 40

	waga produktu netto/ net product weight	ilość sztuk na palecie/ number of items on a pallet	waga palety brutto/ gross pallet weight
Słupek KIOTO uniwersalny (prawy/ lewy)/KIOTO wall hung tall cabinet right/left	35,00	6	247
Lustro KIOTO 130/mirror 130 with light	10,00	6	91
Szafka podumywalkowa KIOTO 130/KIOTO cabinet for washbasins	35,00	6	253
Szafka mobilna KIOTO wenge/KIOTO mobile cabinet wenge	10,00	6	91
Szafka mobilna KIOTO czerwona/KIOTO mobile cabinet red	10,00	6	91
Szafka mobilna KIOTO czarna/KIOTO mobile cabinet black	10,00	6	91
Szafka mobilna KIOTO biała/KIOTO mobile cabinet white	10,00	6	91



p#
500
501

Bilbao

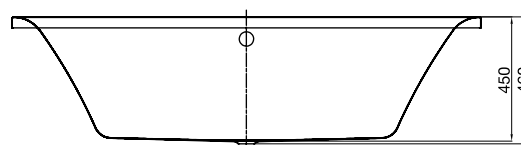
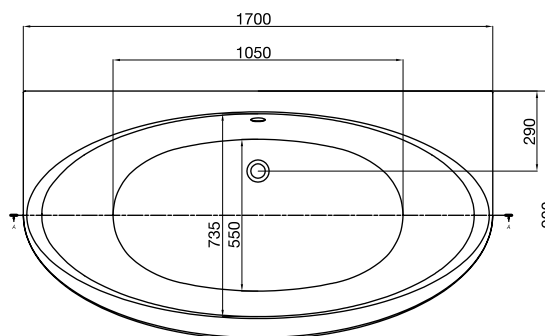

OS-301-004
Wanna akrylowa BILBAO 170
Rozmiar: długość 170; szerokość 90; głębokość 45/
BILBAO 170 bathtub
length 170; width 90; depth 45

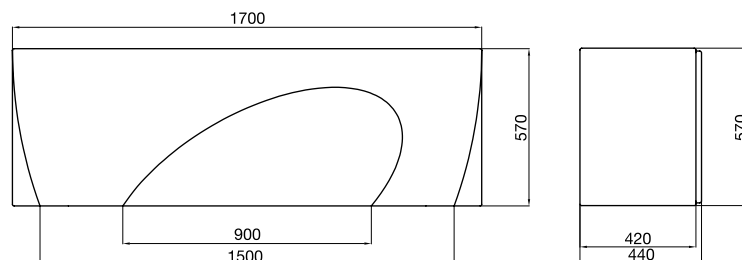

OS-401-005
Panel do wanny BILBAO 170
Rozmiar: długość 170; wysokość 57/
BILBAO 170 front casing
length 170; height 57

OS-401-006
Panel do wanny BILBAO 170 bok
Rozmiar: długość 42; wysokość 57/
BILBAO side casing
length 42; height 57

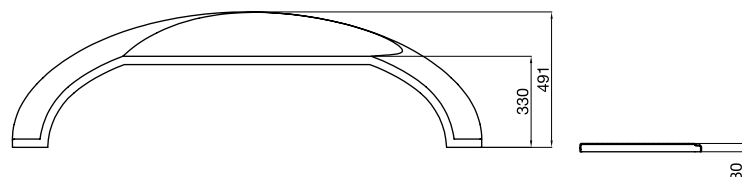

	waga produktu netto/ net product weight	ilość sztuk na palecie/ number of items on a pallet	waga palety brutto/ gross pallet weight
Wanna BILBAO 170x90/BILBAO 170 bathtub	21,00	18	421
Panel czołowy do wanny BILBAO 170/BILBAO 170 front casing	5,00	15	105
Panel boczny do wanny BILBAO/ BILBAO side casing	1,10	25	58

p#
502
503



Kioto

ceramika, meble / ceramics, furniture





OK-02-001
 Umywalka KIOTO 70
 z otworem na armaturę,
 montaż na szafce lub z półpostumentem
 Rozmiar: szerokość 70,5; wysokość 21; głębokość 54/
 KIOTO 70 washbasin
 with hole for mixer,
 assembly with a semi-pedestal or on a countertop.
 width 70,5; height 21; depth 54

OK-02-002
 Umywalka KIOTO 80
 z otworem na armaturę,
 montaż na szafce lub z półpostumentem/
 Rozmiar: szerokość 81; wysokość 20,5; głębokość 55/
 KIOTO 80 washbasin
 with hole for mixer,
 assembly with a semi-pedestal or on a countertop.
 width 81; height 20,5; depth 55

p#
 504
 505

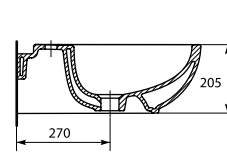
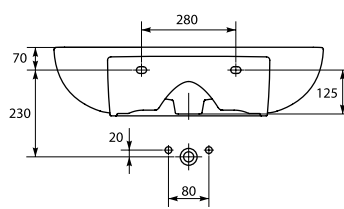
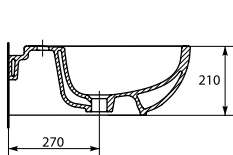
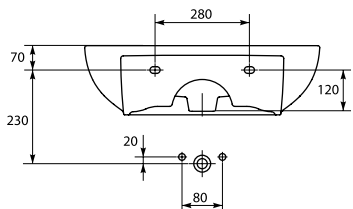
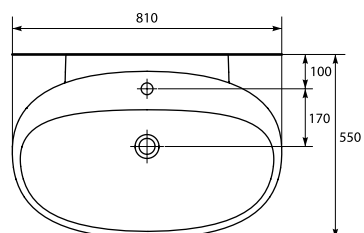
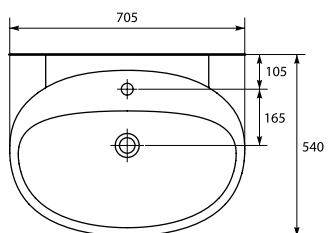

Kioto



OK-02-006
Miska zawieszana KIOTO
Rozmiar: szerokość 39; wysokość 35; głębokość 57,5/
KIOTO wall hung bowl
width 39; height 35; depth 57,5



OK-02-005
Bidet zawieszany KIOTO
Rozmiar: szerokość 39; wysokość 34; głębokość 57,5/
KIOTO wall hung bidet
width 39; height 34; depth 57,5

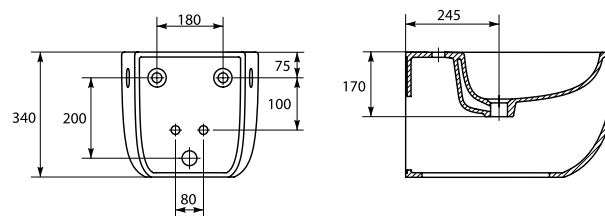
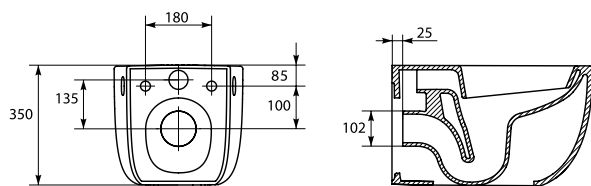
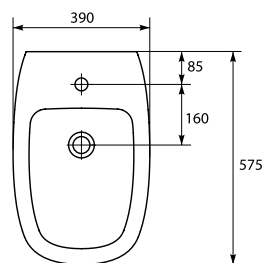
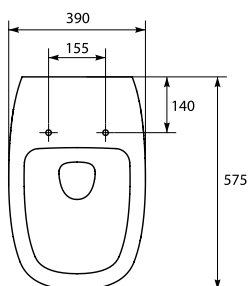

	waga produktu netto/ net product weight	ilość sztuk na paletcie/ number of items on a pallet	waga palety brutto/ gross pallet weight
Umywalka KIOTO 70/KIOTO 70 washbasin	19,0	10	212
Umywalka KIOTO 80/KIOTO 80 washbasin	21,50	10	145
Bidet zawieszany KIOTO/KIOTO wall hung bidet	23,50	8	318
Miska zawieszana KIOTO/KIOTO wall hung bowl	28,30	12	414



p#
506
507

Kioto



OS-502-002
Słupek KIOTO prawy/lewy
Rozmiar: szerokość 35; wysokość 139; głębokość 30/
KIOTO wall hung tall cabinet right/left
width 35; height 139; depth 30



OS-502-003
Lustro KIOTO 130 z oświetleniem
Rozmiar: szerokość 130; wysokość 55; głębokość 8/
KIOTO mirror 130 with light
width 130; height 55; depth 8



OS-502-001
Szafka KIOTO pod umywalki KIOTO 70, 80
Rozmiar: szerokość 130; wysokość 40; głębokość 42/
KIOTO cabinet for KIOTO washbasins 70, 80
width 130; height 40; depth 42



OS-502-004 wenge/wenge, OS-502-005 czerwony/red,
OS-502-006 czarny/black, OS-502-007 biały/white
Kontener z szufladami/
Rozmiar: szerokość 62; wysokość 28,3; głębokość 40/
KIOTO wall hung mobile cabinet
width 62; height 28,3; depth 40

	waga produktu netto/ net product weight	ilość sztuk na palecie/ number of items on a pallet	waga palety brutto/ gross pallet weight
Słupek KIOTO uniwersalny (prawy/ lewy)/KIOTO wall hung tall cabinet right/left	35,00	6	247
Lustro KIOTO 130/mirror 130 with light	10,00	6	91
Szafka podumywalkowa KIOTO 130/KIOTO cabinet for washbasins	35,00	6	253
Szafka mobilna KIOTO wenge/KIOTO mobile cabinet wenge	10,00	6	91
Szafka mobilna KIOTO czerwona/KIOTO mobile cabinet red	10,00	6	91
Szafka mobilna KIOTO czarna/KIOTO mobile cabinet black	10,00	6	91
Szafka mobilna KIOTO biała/KIOTO mobile cabinet white	10,00	6	91

p#
508
509





Malmö

ceramika, wanny / ceramics, bathtubs



OK-01-001
Umywalka MALMO 60
z otworem na armaturę, montaż na szafce
Rozmiar: szerokość 60; wysokość 18,5; głębokość 49/
MALMO 60 washbasin
with hole for mixer, assembly on bathroom cabinet
width 60; height 18,5; depth 49

p#
510
511

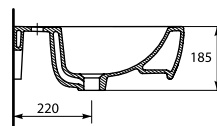
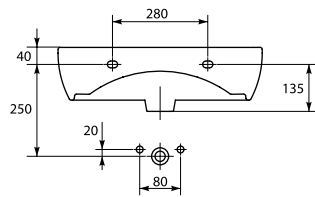
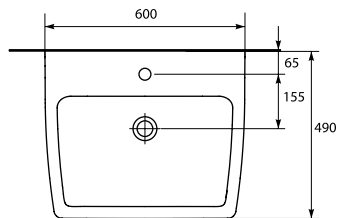

Malmo



Szklane wstawki maskujące śruby montażowe dostępne są w dwóch kolorach: kasztan oraz wenge/
Glass inserts masking mounting screws are available in two colors: chestnut and wenge

OK-01-005
Miska zawieszana MALMO
Rozmiar: szerokość 36,5; wysokość 36; głębokość 58/
MALMO wall hung lavatory bowl
width 36,5; height 36; depth 58

OK-01-004
Bidet zawieszany MALMO
Rozmiar: szerokość 36,5; wysokość 36; głębokość 58,5/
MALMO wall hung bidet
width 36,5; height 36; depth 58,5

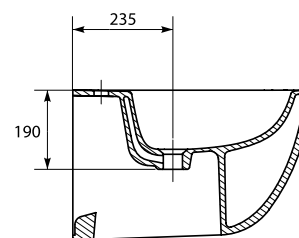
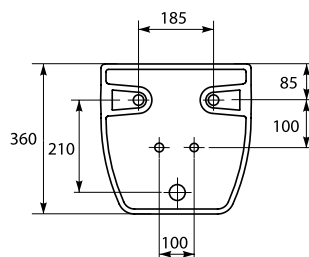
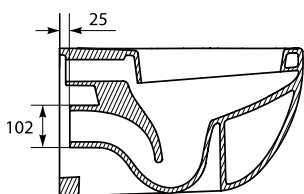
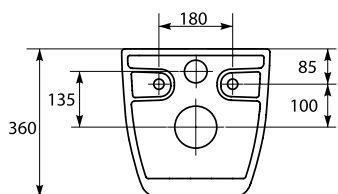
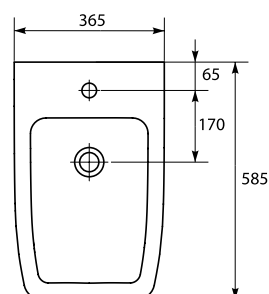
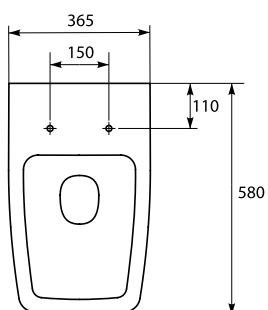

	waga produktu netto/ net product weight	ilość sztuk na palecie/ number of items on a pallet	waga palety brutto/ gross pallet weight
Umywarka MALMO 60/MALMO 60 washbasin	15,50	10	197
Miska zawieszana MALMO/MALMO wall hung bowl	29,00	8	305
Bidet zawieszany MALMO/MALMO wall hung bidet	24,80	8	248



p#
512
513

Malmo



05-301-003
Wanna prostokątna MALMO 180
Rozmiar: długość 180; szerokość 80; głębokość 45,5/
MALMO 180 rectangular bathtub
length 180; width 80; depth 45,5



05-401-003 czołowy/front,
05-401-004 boczny/side,
Panele do wanny prostokątnej MALMO 180
Rozmiar (panel czołowy): długość 180; wysokość 58
Rozmiar (panel boczny): długość 71; wysokość 58/
MALMO 180 casing
(front casing) length 180; height 58
(side casing) length 71; height 58

Wanny sprzedawane są w komplecie z zagłówkiem,
syfonem i nóżkami do montażu./
Complete with headrest, trap and feet for installation.

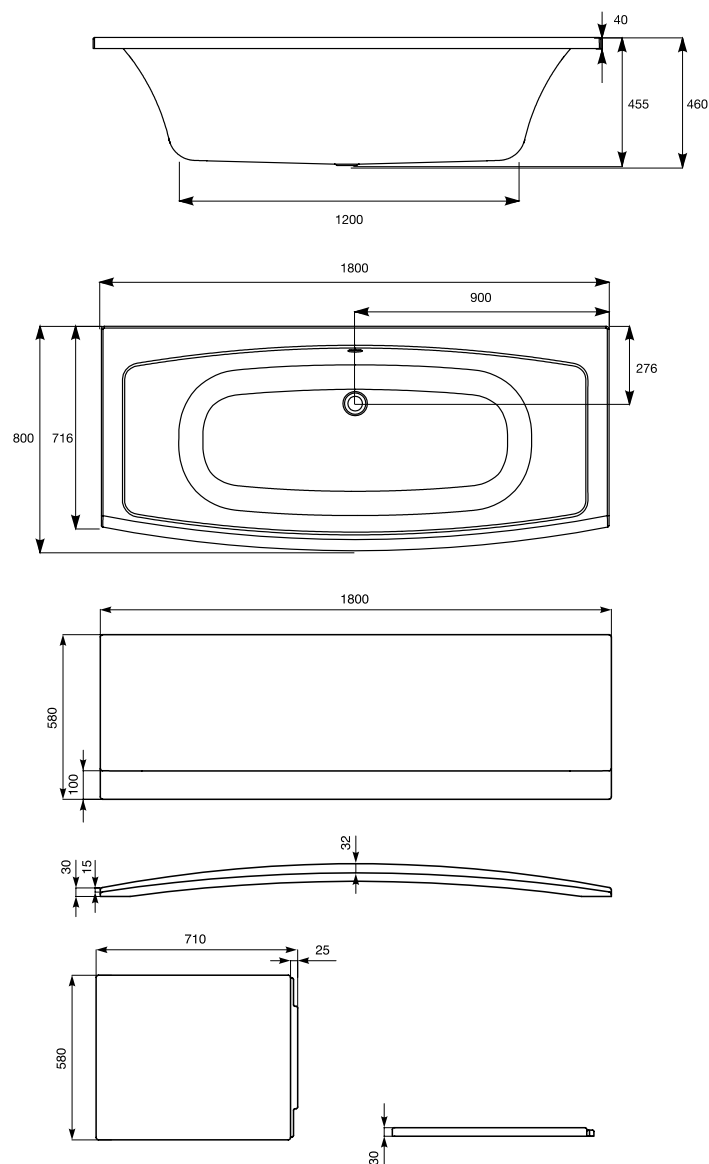

	waga produktu netto/ net product weight	ilość sztuk na palecie/ number of items on a pallet	waga palety brutto/ gross pallet weight
Wanna prostokątna MALMO 180x80/ MALMO 180 rectangular bathtub	24,00	18	475
Panel czołowy do wanny MALMO 180/ MALMO 180 front casing	4,40	15	96
Panel boczny do wanny MALMO/ MALMO 180 side casing	1,70	25	73

Informacje techniczne

Technical
information

PŁYTKI ŚCIENNE









WALL TILES

CHARAKTERYSTYKA TECHNICZNA PŁYTEK CERAMICZNYCH ŚCIENNYCH

Płytki ceramiczne ściennie posiadają parametry zgodne z normą PN-EN 14411 wg załącznika L „Płytki ceramiczne prasowane na sucho” E>10%, Grupa B III GL

TECHNICAL SPECIFICATION OF CERAMIC WALL TILES

The ceramic wall tiles are manufactured in accordance with the PN-EN 14411 standard as described in Appendix L, "Dry-pressed ceramic tiles" E>10%, Group B III GL.

Właściwości Properties	Badanie wg: Test made acc. to:	Wymagania Requirements	Parametry płytek Tiles parameters
 Nasiąkliwość wodna (%) Permeability to water (%)	PN-EN ISO 10545-3	> 10	> 10
 Wytrzymałość na zginanie (MPa) Bending strength (MPa)	PN-EN ISO 10545-4	≥ 7,5 mm; min. 15 < 7,5 mm; min. 12	min. 15
 Siła łamiąca (N) Breaking strength (N)	PN-EN ISO 10545-4	≥ 7,5 mm: min. 600 < 7,5 mm: min. 200	≥ 7,5 mm: min. 800 < 7,5 mm: min. 400
 Odporność na pęknięcia włoskowate Crazing resistance	PN-EN ISO 10545-11	required / wymagana	resistant / odporne
 Współczynnik cieplnej rozszerzalności liniowej (10 ⁻⁶ /°C) Coefficient of linear thermal expansion (10 ⁻⁶ /°C)	PN-EN ISO 10545-8	s.m.b. *	<9
 Odporność na kwasy i zasady o słabym stężeniu Resistance to weak solutions of acids and alkali	PN-EN ISO 10545-13	s.m.b. *	GLA-GLB
 Odporność na działanie środków domowego użytku i soli do basenów kąpielowych Resistance to household chemicals and swimming-pool salts	PN-EN ISO 10545-13	min. GB	GA
 Odporność na plamienie Resistance to stains	PN-EN ISO 10545-14	min. klasa 3	5 klasa

* stosowana metoda badania

* method of testing used

Informacje techniczne
Technical information

PŁYTKI PODŁOGOWE











FLOOR TILES

CHARAKTERYSTYKA TECHNICZNA PŁYTEK CERAMICZNYCH PODŁOGOWYCH

Płytki ceramiczne podłogowe posiadają parametry zgodne z normą PN-EN 14411, wg załącznika J „Płytki ceramiczne prasowane na sucho” $3 < E \leq 6\%$, Grupa B IIa GL.

TECHNICAL SPECIFICATION OF CERAMIC FLOOR TILES

Ceramic floor tiles are manufactured in accordance with the PN-EN 14411 standard as described in Appendix J, “Dry-pressed ceramic tiles” $3 < E \leq 6\%$, Group B IIa GL.

Właściwości Properties	Badanie wg: Test made acc. to:	Wymagania Requirements	Parametry płytek Tiles parameters
 Nasiąkliwość wodna (%) Permeability to water (%)	PN-EN ISO 10545-3	$3 < E \leq 6$	4
 Wytrzymałość na zginanie (MPa) Bending strength (MPa)	PN-EN ISO 10545-4	min. 22	min. 35
 Siła łamiąca (N) Breaking strength (N)	PN-EN ISO 10545-4	$\geq 7,5$ mm: min. 1000 $< 7,5$ mm: min. 600	$\geq 7,5$ mm: min. 1300 $< 7,5$ mm: min. 1000
 Odporność na pęknięcia włoskowate Crazing resistance	PN-EN ISO 10545-11	wymagana / required	odporne / resistant
 Współczynnik cieplnej rozszerzalności liniowej ($10^{-6}/^{\circ}\text{C}$) Coefficient of linear thermal expansion ($10^{-6}/^{\circ}\text{C}$)	PN-EN ISO 10545-8	s.m.b. *	< 9
 Odporność na ścieranie (klasa) Abrasion resistance (class)	PN-EN ISO 10545-7	nominal / deklarowana	2-5
 Skuteczność antypoślizgowa (grupa klasyfikacyjna) Slip resistance (classification group)	DIN 51130	wg deklaracji / as declared	NPD
 Odporność na kwasy i zasady o słabym stężeniu Resistance to weak solutions of acids and alkali	PN-EN ISO 10545-13	s.m.b. *	GLA-GLB
 Odporność na działanie środków domowego użytku i soli do basenów kąpielowych Resistance to household chemicals and swimming-pool salts	PN-EN ISO 10545-13	min. GB	GA
 Odporność na plamienie Resistance to stains	PN-EN ISO 10545-14	min. 3 klasa	5 klasa

* stosowana metoda badania
* method of testing used

GRES PORCELLANATO











NON-GLAZED STONEWARE

CHARAKTERYSTYKA TECHNICZNA PŁYTEK GRES PORCELLANATO NIESZKLIWIONY

Płytki gres porcellanato nieszkliwione posiadają parametry zgodne z normą PN-EN 14411, wg załącznika G, „Płytki ceramiczne prasowane na sucho o małej nasiąkliwości wodnej” $E \leq 0,5\%$, Grupa B Ia UGL.

TECHNICAL SPECIFICATION OF UNGLAZED PORCELAIN STONEWARE TILES

The unglazed porcelain stoneware tiles are manufactured in accordance with the PN-EN 14411 standard as described in Appendix G “Low water absorbability dry-pressed ceramic tiles” $E \leq 0.5\%$, Group B Ia UGL.

Właściwości Properties	Badanie wg: Test made acc. to:	Wymagania Requirements	Parametry płytek Tiles parameters
 Nasiąkliwość wodna (%) Permeability to water (%)	PN-EN ISO 10545-3	$E \leq 0.5$	0.1
 Wytrzymałość na zginanie (MPa) Bending strength (MPa)	PN-EN ISO 10545-4	min. 35	min. 40 min. 50 (dla płytek 200x200x12)
 Siła łamiąca (N) Breaking strength (N)	PN-EN ISO 10545-4	< 7,5 mm: min. 700 ≥ 7,5 mm: min. 1300	< 7,5 mm: min. 1300 ≥ 7,5 mm: min. 1800 ≥ 12 mm: min. 5000
 Współczynnik cieplnej rozszerzalności liniowej ($10^{-6}/^{\circ}\text{C}$) Coefficient of linear thermal expansion ($10^{-6}/^{\circ}\text{C}$)	PN-EN ISO 10545-8	s.m.b. *	<9
 Mrozoodporność Frost resistance	PN-EN ISO 10545-12	wymagana / required	mrozoodporność / frost resistance
 Odporność na ścieranie wgłębne (mm^3) Deep scratch resistance (mm^3)	PN-EN ISO 10545-6	max. 175	max. 130
 Skuteczność antypoślizgowa (grupa klasyfikacyjna) Slip resistance (classification group)	DIN 51130	wg deklaracji / as declared	NPD, R9, R10, R11, R12
 Odporność na kwasy i zasady o słabym stężeniu Resistance to weak solutions of acids and alkali	a) PN-EN ISO 10545-13 b) PN-EN ISO 10545-13	s.m.b. * s.m.b. *	ULA-ULB UHA-UHB
 Odporność na działanie środków domowego użytku i soli do basenów kąpielowych Resistance to household chemicals and swimming-pool salts	PN-EN ISO 10545-13	min. UB	GA
 Odporność na plamienie Resistance to stains	PN-EN ISO 10545-14	s.m.b. *	klasa (3-5) polerowane (2-5)

* stosowana metoda badania
* method of testing used

Informacje techniczne
Technical information

p#
518
519

GRES PORCELLANATO SZKLIWIONY











GLAZED STONEWARE

TECHNICAL SPECIFICATION OF GLAZED PORCELAIN STONEWARE TILES AND BORDERS.

Glazed porcelain stoneware tiles and borders are manufactured in accordance, with the PN-EN 14411 standard as described in Appendix G "Low water absorbability dry-pressed ceramic tiles" $E \leq 0.5\%$, Group B la GL.

CHARAKTERYSTYKA TECHNICZNA PŁYTEK I LISTEW GRES PORCELLANATO SZKLIWIONY

Płytki i listwy gres porcellanato szklwione posiadają parametry zgodne z normą PN-EN 14411, wg załącznika G „Płytki ceramiczne prasowane na sucho o małej nasiąkliwości wodnej” $E \leq 0,5\%$, Grupa B la GL.

Właściwości Properties	Badanie wg: Test made acc. to:	Wymagania Requirements	Parametry płytek Tiles parameters
 Nasiąkliwość wodna (%) Permeability to water (%)	PN-EN ISO 10545-3	$E \leq 0.5$	0.1
 Wytrzymałość na zginanie (MPa) Bending strength (MPa)	PN-EN ISO 10545-4	min. 35	min. 40
 Siła łamiąca (N) Breaking strength (N)	PN-EN ISO 10545-4	< 7,5 mm: min. 700 ≥ 7,5 mm: min. 1300	< 7,5 mm: min. 1300 ≥ 7,5 mm: min. 1800
 Odporność na pęknięcia włoskowate Crazing resistance	PN-EN ISO 10545-11	wymagana / required	odporne / resistant
 Współczynnik cieplnej rozszerzalności liniowej ($10^{-6}/^{\circ}\text{C}$) Coefficient of linear thermal expansion ($10^{-6}/^{\circ}\text{C}$)	PN-EN ISO 10545-8	s.m.b. *	<9
 Mrozoodporność Frost resistance	PN-EN ISO 10545-12	wymagana / required	mrozoodporność / frost resistance
 Odporność na ścieranie (klasa) Abrasion resistance (class)	PN-EN ISO 10545-7	deklarowana / nominal	2-5
 Skuteczność antypoślizgowa (grupa klasyfikacyjna) Slip resistance (classification group)	DIN 51130	wg deklaracji / as declared	NPD, R9, R10, R11
 Odporność na kwasy i zasady o słabym stężeniu Resistance to weak solutions of acids and alkali	PN-EN ISO 10545-13	s.m.b. *	GLA-GLB
 Odporność na działanie środków domowego użytku i soli do basenów kąpielowych Resistance to household chemicals and swimming-pool salts	PN-EN ISO 10545-13	min. GB	GA
 Odporność na plamienie Resistance to stains	PN-EN ISO 10545-14	min. 3 klasa	5 klasa

* stosowana metoda badania
* method of testing used

PŁYTKI KLINKIEROWE NIESZKLIWIONE SIMPLE, SHADOW











NON-GLAZED CLINKER TILES SIMPLE, SHADOW

CHARAKTERYSTYKA TECHNICZNA PŁYTEK KLINKIEROWYCH

Płytki klinkierowe posiadają parametry zgodne z normą PN-EN 14411, wg załącznika H, „Płytki ceramiczne prasowane na sucho o małej nasiąkliwości wodnej” 0,5% < E < 3% Grupa B1b, uGL

TECHNICAL SPECIFICATION OF CLINKER

The clinker tiles are manufactured in accordance with the PN-EN 14411 standard as described in Appendix H “Low water absorbability dry-passed ceramic tiles” 0,5% < E < 3% Group B1b

Właściwości Properties	Badanie wg: Test made acc. to:	Wymagania Requirements	Parametry płytek Tiles parameters
 Nasiąkliwość wodna (%) Permeability to water (%)	PN-EN ISO 10545-3	0,5% < E ≤ 3%	0,5 – 2
 Wytrzymałość na zginanie (MPa) Bending strength (MPa)	PN-EN ISO 10545-4	min. 30	> 40
 Siła łamiąca (N) Breaking strength (N)	PN-EN ISO 10545-4	< 7,5 mm: min. 700 ≥ 7,5 mm: min. 1100	> 1300 > 2600
 Współczynnik cieplnej rozszerzalności liniowej (10 ⁻⁶ /°C) Coefficient of linear thermal expansion (10 ⁻⁶ /°C)	PN-EN ISO 10545-8	s.m.b. *	<9
 Mrozoodporność Frost resistance	PN-EN ISO 10545-12	wymagana / required	mrozoodporność / frost resistance
 Odporność na ścieranie głębokie (mm ³) Deep scratch resistance (mm ³)	PN-EN ISO 10545-6	max. 175	140
 Skuteczność antypoślizgowa (grupa klasyfikacyjna) Slip resistance (classification group)	DIN 51130	wg deklaracji / as declared	R9 – płytki gładkie R9 – smooth tiles R10 – płytki strukturalne (3-d) R10 – structure tiles
 Odporność na odczynniki chemiczne: a) na kwasy i zasady o słabym natężeniu, b) na kwasy i zasady o mocnym stężeniu Resistance to chemicals: a) weak solutions of acids and alkali, b) potent solutions of acids and alkali	PN-EN ISO 10545-13	s.m.b. *	ULA-ULB UHA-UHB
 Odporność na działanie środków domowego użytku i soli do basenów kąpielowych Resistance to household chemicals and swimming-pool salts	PN-EN ISO 10545-13	min. UB	UA
 Odporność na plamienie Resistance to stains	PN-EN ISO 10545-14	s.m.b. *	3 – 5 klasa

* stosowana metoda badania
* method of testing used

Informacje techniczne
Technical information

PŁYTKI KLINKIEROWE SZKLIWIONE SOLAR











PŁYTKI KLINKIEROWE SZKLIWIONE SOLAR

CHARAKTERYSTYKA TECHNICZNA PŁYTEK KLINKIEROWYCH SZKLIWIONYCH

Płytki klinkierowe posiadają parametry zgodne z normą PN-EN 14411, wg załącznika H, „Płytki ceramiczne prasowane na sucho o małej nasiąkliwości wodnej” 0,5% < E < 3% Grupa Blb, GL

TECHNICAL SPECIFICATION OF GLAZED CLINKER

The clinker tiles are manufactured in accordance with the PN-EN 14411 standard as described in Appendix H “Low water absorbability dry-passed ceramic tiles” 0,5% < E < 3% Group Blb, GL

Właściwości Properties	Badanie wg: Test made acc. to:	Wymagania Requirements	Parametry płytek Tiles parameters
 Nasiąkliwość wodna (%) Permeability to water (%)	PN-EN ISO 10545-3	0,5% < E ≤ 3%	0,5 – 2,5
 Wytrzymałość na zginanie (MPa) Bending strength (MPa)	PN-EN ISO 10545-4	min. 30; pojedynczy min. 27	min. 40
 Siła łamiąca (N) Breaking strength (N)	PN-EN ISO 10545-4	< 7,5 mm: min. 700 ≥ 7,5 mm: min. 1100	> 1300 > 2600
 Odporność na pęknięcia włoskowate Crazing resistance	PN-EN ISO 10545-11	wymagana / required	resistant / odporne
 Mrozoodporność Frost resistance	PN-EN ISO 10545-12	wymagana / required	mrozoodporność / frost resistance
 Współczynnik cieplnej rozszerzalności liniowej (10 ⁻⁶ /°C) Coefficient of linear thermal expansion (10 ⁻⁶ /°C)	PN-EN ISO 10545-8	s.m.b. *	<9
 Odporność na ścieranie (klasa) Abrasion resistance (class)	PN-EN ISO 10545-7	nominal / deklarowana	3-4
 Skuteczność antypoślizgowa (grupa klasyfikacyjna) Slip resistance (classification group)	DIN 51130	s.m.b. *	R10
 Odporność na kwasy i zasady o słabym stężeniu Resistance to weak solutions of acids and alkali	PN-EN ISO 10545-13	1. nominal / deklarowana *	1. GLA, GLB 2. GHA, GHB
 Odporność na działanie środków domowego użytku i soli do basenów kąpielowych Resistance to household chemicals and swimming-pool salts	PN-EN ISO 10545-13	min. GB	GA
 Odporność na plamienie Resistance to stains	PN-EN ISO 10545-14	s.m.b. *	5 klasa

* stosowana metoda badania
* method of testing used

ABC PŁYTEK CERAMICZNYCH

ZASADY DOBORU PŁYTEK

Dokonując wyboru płytek, oprócz walorów estetycznych, należy wziąć pod uwagę przede wszystkim szczególne warunki, w których płytka będzie eksploatowana. Jako okładziny ścian wewnętrznych można stosować wszystkie płytki marki Opoczno. Na pokrycia podłóg wewnątrz budynków należy stosować płytki podłogowe, gresowe lub płytki klinkierowe. Przy wyborze płytek na podłogę należy mieć na uwadze przewidywane natężenie ruchu i wybrać płytki o odpowiedniej odporności na ścieranie (płytki podłogowe szklwione, gres szklwiony). W miejscach gdzie zachodzi duże prawdopodobieństwo poślizgu stosuje się płytki posiadające cechy antypoślizgowe. Przy wyborze płytek polerowanych należy pamiętać o ich szczególnie śliskiej powierzchni. W pomieszczeniach z przewidywanym dużym natężeniem ruchu zalecamy stosowanie gresów nieszkliwionych. Na zewnątrz budynków stosujemy tylko płytki gresowe lub klinkierowe, które są odporne na działanie ujemnych temperatur.

KLASA ŚCIERALNOŚCI

- 2 – produkt zalecany do pomieszczeń domowych o niskim natężeniu ruchu, np. łazienka
- 3 – produkt zalecany do pomieszczeń domowych o niskim i średnim natężeniu ruchu, typu łazienka, kuchnia, salon, przedpokój, taras
- 4 – produkt zalecany do stosowania w miejscach o normalnym natężeniu ruchu, np. budynki mieszkalne oraz użyteczności publicznej
- 5 – produkt zalecany do stosowania w miejscach wzmożonego natężenia ruchu, takich jak: centra handlowe, przejścia i korytarze, miejsca publiczne

ODCIEŃ PŁYTEK

ODCIEŃ – różnica w intensywności barwy poszczególnych dekoracji na płytce w stosunku do przyjętego wzorca. Dla gresu nieszkliwionego – różnica w ilości lub intensywności kolorowej bazy dająca zmianę wybarwienia całej powierzchni płytki w stosunku do wzorca. Oznaczenie odcienia znajduje się na każdym jednostkowym opakowaniu. Płytki przeznaczone do wyłożenia w jednym pomieszczeniu muszą zawierać takie same oznaczenia odcienia na wszystkich opakowaniach. Płytki ceramiczne oznaczone jednym odcieniem mogą posiadać niewielkie różnice grafiki wzoru i kolorystyki, wynikające z technologii produkcji. Gres nieszkliwiony polerowany i satynowany wyróżnia się niepowtarzalnością wzoru na poszczególnych płytkach. Może posiadać również niewielkie różnice barwy. Przed układaniem wszystkich ww. płytek sugeruje się rozłożenie płytek z różnych opakowań oraz ich wymieszanie. Efekt cieniowania w przypadku płytek rustykalnych jest zamierzony.

ANTYPOŚLIZGOWOŚĆ

Jest to ważna cecha dla płytek, które stosuje się jako okładzinę podłogową w warunkach wymagających zwiększonej skuteczności przeciwpoślizgowej. Płytki, która ma powierzchnię strukturalną lub reliefową ma określoną skuteczność przeciwdziałania poślizgom. O tejsze skuteczności informuje współczynnik R czyli kąt przy którym dochodzi do poślizgu (wg niemieckiej normy DIN 51130) Zakres kąta - Klasy antypoślizgowości
6-10 – klasa R9
10-19 – klasa R10
19-27 – klasa R11
27-35 – klasa R12
Powyżej 35 – klasa R13

CHEMOODPORNOŚĆ

W warunkach szczególnych, gdzie istnieje prawdopodobieństwo rozlania substancji kwasowych lub zasadowych ważne jest aby płytka posiadała odporność chemiczną na tego rodzaju czynniki chemiczne. Wszystkie płytki marki Opoczno badane są pod kątem odporności na kwasy, zasady oraz składniki wody basenowej. Najwyższą odporność wykazują płytki gres szklwiony i nieszkliwiony- odporne są na działanie również mocnych roztworów kwasów i zasad wg PN-EN 10545-13. Parametr ten jest istotny przy układaniu płytek w zakładach przemysłowych, w przemyśle spożywczym, chemicznym, basenach kąpielowych.

MROZOODPORNOŚĆ

Jest to parametr określający odporność płytek ceramicznych na temperatury ujemne. Płytki w trakcie badania poddawane są 100 cyklom zamrażania i rozmrażania. W trakcie rozmrażania woda penetruje w głąb płytki a w trakcie zamrażania zgromadzona woda w płytce zamraża zwiększając swoją objętość. Jeżeli płytka jest mocno spieczona tak jak gres lub klinkier to ilość zgromadzonej wody jest na tyle mała, że nie powoduje uszkodzenia płytki. Należy pamiętać, że sama mrozoodporność płytki w żadnym wypadku nie gwarantuje końcowego efektu, czyli trwałej wykładziny ceramicznej np na tarasie. O tym decyduje właściwe wykonanie prac montażowych i użycie odpowiednich materiałów budowlanych do montażu płytek na zewnątrz.

NASIAKLIWOŚĆ

Nasiąkliwość płytki to zdolność do pochłaniania i zatrzymywania wody. Jest to podstawowe kryterium dzielące płytki wg ich własności:
Grupa BIa – płytki gresowe o niskiej nasiąkliwości $E \leq 0,5\%$;
Grupa BIb – płytki klinkierowe o nasiąkliwości $0,5\% < E < 3\%$;
Grupa BIIa – płytki podłogowe o nasiąkliwości $3 < E < 6\%$;
Grupa BIII – płytki ściennie o nasiąkliwości $E > 10\%$.
Parametr nasiąkliwości jest ściśle związany z strukturą wewnętrzną płytki wynikającą z technologii produkcji. Im mniej wolnych przestrzeni w strukturze płytki, tym mniejsza nasiąkliwość i lepsze parametry użytkowe płytki jak: wytrzymałość na złamanie, czy mrozoodporność. W warunkach użytkowania chłonność płytki może być zmniejszona przez zastosowanie odpowiednich fug. Pochłanianie wody w płytkach szklwionych następuje jedynie od strony nie pokrytej szkliwem.

ODPORNOŚĆ NA PLAMIE

To ważna cecha użytkowa, o której należy pamiętać przy wyborze rodzaju płytek, przeznaczonych do układania w miejscach narażonych na działanie substancji paliących (kuchnie, garaże, hale przemysłowe itd). Płytki szklwione z racji posiadania warstwy szkliwa na powierzchni są łatwiej zmywalne i uzyskują najwyższe klasy odporności na plamienie. Płytki gres nieszkliwiony są bardziej skłonne do zaplamień dlatego też zalecamy dla płytek nieszkliwionych pokrycie ich środkiem chemicznym ułatwiającym utrzymanie ich w czystości i chroniącym przed plamami.

REKTYFIKACJA

Proces rektyfikacji jest mechaniczną obróbką boków płytek i polega na bardzo dokładnym docięciu ich brzegów pod określony wymiar, zwykle z dokładnością do $\pm 0,3$ mm. Płytki rektyfikowane cechują się zdecydowanie większą dokładnością wymiarową niż płytki nierektyfikowane – sortowane na grupy wymiarowe. Niewielkie różnice wymiarowe pomiędzy płytkami rektyfikowanymi pozwalają na zastosowanie minimalnych fug pomiędzy płytkami tj. 1mm.

FUGI

Spoina, jest estetycznym dopełnieniem ceramicznej lub kamiennej posadzki. Fuga stanowi również swoistą dylatację pomiędzy płytkami, pozwalającą na ich minimalne odkształcenia, zwłaszcza gdy praca podłoża prowadzi do wystąpienia naprężeń np. w przypadku ogrzewania podłogowego. Fugi pozwalają też zniwelować różnice wymiarowe płytek. Szerokość fugi zależy przede wszystkim od wymiarów płytki, należy pamiętać o tym, żeby dobrać właściwy rodzaj spoiny do określonej szerokości. Miejsca wilgotne, na ogrzewaniu podłogowym lub w temperaturach ujemnych wymagają innego rodzaju fug.

TRANSPORT

Podczas transportu należy jednostki ładunkowe ustawiać ściśle obok siebie. Wolne przestrzenie należy zabezpieczyć, uniemożliwiając przesuwanie się ładunku podczas transportu.

PRZECHOWYWANIE

Płytki należy przechowywać w pomieszczeniach chroniących je przed zawilgoceniem, a w przypadku płytek niemrozoodpornych należy je chronić również przed temperaturą mniejszą lub równą 0°C . Nie uważa się za wady produkcyjne defektów spowodowanych przechowywaniem płytek niemrozoodpornych w temperaturze poniżej 0°C , bądź zmian w płytkach spowodowanych ich niewłaściwym przechowywaniem przed dokonaniem montażu.

REFERENCE GUIDE TO CERAMIC TILES

TILE SELECTION CRITERIA

When selecting tiles, apart from attractive design, it is important to take into consideration specific conditions in which a tile is going to be used. All Opoczno tiles can be used as interior wall tiling. Floors inside buildings should be laid with floor tiles, stoneware or clinker tiles. When selecting floor tiles it is important to take into consideration predicted traffic volume and select tiles with appropriate wear resistance level (glazed floor tiles, glazed stoneware). Anti-slip floor tiles are used in places with a strong risk of slipping. When selecting polished tiles remember about their slippery surface. In rooms with predicted high traffic volume we recommend using non-glazed stoneware tiles. Outside buildings we only use stoneware or clinker tiles, which are resistant to temperatures below zero degrees.

ABRASION-RESISTANCE CLASS

- 2 – product recommended for house rooms with low intensity of traffic e.g. a bathroom
- 3 – product recommended for house rooms with low and medium intensity of traffic e.g. a bathroom, a kitchen, a living room, a hall or a terrace
- 4 – product recommended to be applied in places of normal intensity of traffic, e.g. residence buildings and public utility buildings
- 5 – product recommended to be applied in places of increased intensity of traffic, such as: shopping centres, passages and corridors, public places

TILE SHADE

SHADE – a difference in the intensity of colours in individual decorations on a tile in proportion to the assumed pattern. Non-glazed stoneware – a difference in the amount or colour intensity of the base, which results in the change of dyeing of the entire surface of the tile in proportion to the pattern. Shade designation is placed in every single box. Tiles to be laid in one room must have an identical shade designation on all boxes. Ceramic tiles marked with one shade may have slight differences in the pattern graphics and colouring caused by manufacturing technology. Polished non-glazed and satin-finished stoneware is distinguished by the uniqueness of the pattern on the individual tiles. It also may have slight differences in colour. Before laying all the abovementioned tiles, it is recommended to spread the tiles from different boxes and mix them. Shading effect in the case of rustic tiles is intended.

ANTI-SLIP PROPERTIES

It is a very important feature of tiles, which are used as floor tiling in the where increased anti-slip efficiency is required. Tiles with structural or relief surface have specified anti-slip efficiency. This efficiency is defined by an R coefficient – an angle at which slipping occurs (according to German standard DIN 51130)

Angle range - Anti-slip classes

- 6-10 – class R9
- 10-19 – class R10
- 19-27 – class R11
- 27-35 – class R12
- Above 35 – class R13

CHEMICAL RESISTANCE

In specific conditions, with a risk of spilling acid or or base it is important that a tile is resistant to these chemicals. All Opoczno tiles are examined for acids, bases and pool water components. Glazed and non-glazed stoneware tiles show best resistance – also resistance to strong solutions of acids and bases according to PN-EN 10545-13. This parameter is essential when laying tiles in industrial plants, in foodstuff and chemical industries or swimming pools.

FROST RESISTANCE

This parameter specifies the resistance of ceramic tiles to negative temperatures. During the examination, tiles are subjected to 100 cycles of freezing and defrosting. While defrosting water penetrates a tile and while freezing water accumulated in a tile freezes and increases its volume. If a tile is sintered as hard as stoneware or clinker then the amount of accumulated water so low that it does not damage the tile. Remember that a tile's frost resistance by no means guarantee a final result – durable ceramic flooring, e.g. on a terrace. It is determined by proper installation works and using adequate construction materials for the installation of tiles outside.

ABSORBABILITY

Tile absorbability is a capacity to absorb and retain water. It is a basic criterion, which divides tiles according to their properties:

- Group Bla – stoneware tiles with low absorbability of $E \leq 0.5\%$;
- Group Blb – clinker tiles with absorbability of $0.5\% < E < 3\%$;
- Group Blla – floor tiles with absorbability of $3 < E < 6\%$;
- Group Blll – floor tiles with absorbability of $E > 10\%$.

Tile absorbability parameter is closely linked to the tile's internal structure resulting from manufacturing technology. The less free spaces in the structure of the tile, the less absorbability and better operating parameters of the tile, such as: fracture resistance, frost resistance. In operating conditions, the absorbing capacity of the tile can be decreased by: the application of adequate joints. Water absorption in glazed tiles takes place only from the side, which is not glazed.

STAIN RESISTANCE

It is an important performance trait, which should be taken into account while selecting the type of tiles, which are to be laid in places exposed to the activity of staining substances (in kitchens, garages, industrial facilities etc.). Glazed tiles, due to a glaze layer on the surface, are washable and achieve the highest class of stain resistance. Non-glazed stoneware tiles are more susceptible to stains, therefore we recommend coating them with a chemical, which helps to keep them clean and protects them from stains.

RECTIFICATION

Rectification is a mechanical treatment of tile sides and consists in very accurate cutting of their edges to a specified size, usually to within ± 0.3 mm. Rectified tiles are characterized by decidedly better size accuracy than non-rectified tiles sorted into size groups. Slight size differences between rectified tiles allow you to use minimum joints between tiles, i.e. 1mm.

JOINTS

Joint is an aesthetic supplement of the ceramic or stone floor. It is also a specific expansion joint between the tiles, which allows them to deform minimally, particularly when the activity of the bed leads to stresses, e.g. in the case of floor heating. Joints enable us to level the tiles' size differences. The width of the joint especially depends on the size of the tile; it should be remembered to match the right size of the joint to the specific width. Damp places, on floor heating or in temperatures below zero require a different type of joints.

TRANSPORTATION

While transporting tiles, unit loads should be arranged tightly side by side. Free spaces should be secured to prevent from shifting the load during transportation.

STORAGE

Tiles should be stored in rooms, which protect them from moisture, and non frost-proof tiles should be also protected from temperatures lower or equal to 0°C . Defects caused by the storage of non frost-proof tiles in the temperature above 0°C , or changes in tiles caused by their improper storage prior to the installation are not considered as manufacturing defects.



LEGENDA

KEY



PL wymiary płytek
GB tiles sizes



PL grubość płytki
GB tile thickness



PL ilość sztuk płytek w kartonie
GB number of tiles per box



PL ilość m² w jednym kartonie
GB square meters covered by one box of tiles



PL waga płytek w jednym kartonie
GB tiles weight in one box



PL ilość kg w 1 m² płytek
GB kilograms per one square meters of tiles



PL ilość m² płytek na palecie
GB square meters covered by one pallet of tiles



PL kolekcja błyszcząca
GB glossy tiles



PL kolekcja matowa
GB matt tiles



PL kolekcja rektyfikowana
GB rectificated tiles



PL kolekcja strukturalna
GB structured tiles



PL klasa ścieralności
GB abrasion-resistance class



PL klasa antypoślizgowości
GB non-slip class



PL płytko mrozoodporna
GB frost-resistant tile



www.opoczno.eu

Infoline: 801 01 44 66

Infolinia dostępna w godz. 8.00-17.00

Opłata wg cennika operatora

Katalog jest materiałem poglądowym. Producent zastrzega sobie prawo zmian w ofercie przedstawionej w katalogu.

Ze względu na stosowaną technikę druku rzeczywisty wygląd płytek może różnić się od produktów prezentowanych na zdjęciach.

This catalogue is a demonstrative material. Manufacturer reserves the right to introduce changes in the offer presented in the catalogue.

Owing to the printing technique employed the real appearance of the tiles may be slightly different than the products presented in the pictures.

